



SPLIT-TYPE AIR CONDITIONERS

Changes for the Better

M^{itsubishi}
E^{lectric}
Q^{uality}

Wrap Yourself in Comfort and Quiet
Eco-conscious Technologies from Japan

Full Product Line Catalogue
2019

for a greener tomorrow



Doing Our Part to Create a Better Future for All...

Core Environmental Policy

The Mitsubishi Electric Group promotes sustainable development and is committed to protecting and restoring the global environment through technology, through all its business activities, and through the actions of its employees.

Environmental Vision 2021



Preventing Global Warming

- Reduce CO₂ emissions from product usage by 30%
- Reduce total CO₂ emissions from production by 30%
- Aim to reduce CO₂ emissions from power generation

Creating a Recycling-Based Society

- Reduce, reuse and recycle "3Rs" products reduce resources used by 30%
- Zero emissions from manufacturing reducing the direct landfill of waste to zero

Ensuring Harmony with Nature Fostering Environmental Awareness

The New Refrigerant R32

The new R32 refrigerant has a global warming potential approximately 1/3*1 that of our current refrigerant, R410A; thereby dramatically reducing the negative impact more than ever. Actively introducing the new R32 refrigerant to suppress global warming, Mitsubishi Electric continues to promote manufacturing while considering the environment.

Comparison of Global Warming Potential

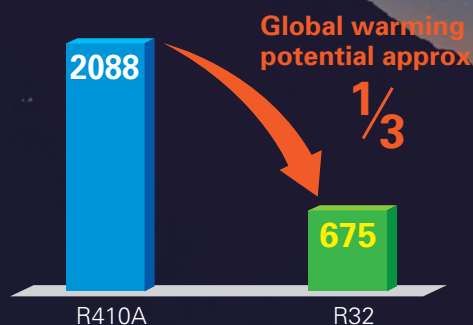

Source: IPCC 4th Assessment Report, global warming potential (GWP) 100-year value. Comparison of 2088 (R410A) and 675 (R32).

Mitsubishi Electric reflects the essence of this policy and vision in all aspects of its air conditioner business as well.

Preventing Global Warming

Heat pump technology inspires Mitsubishi Electric to design air conditioners that harmonize comfort and ecology.

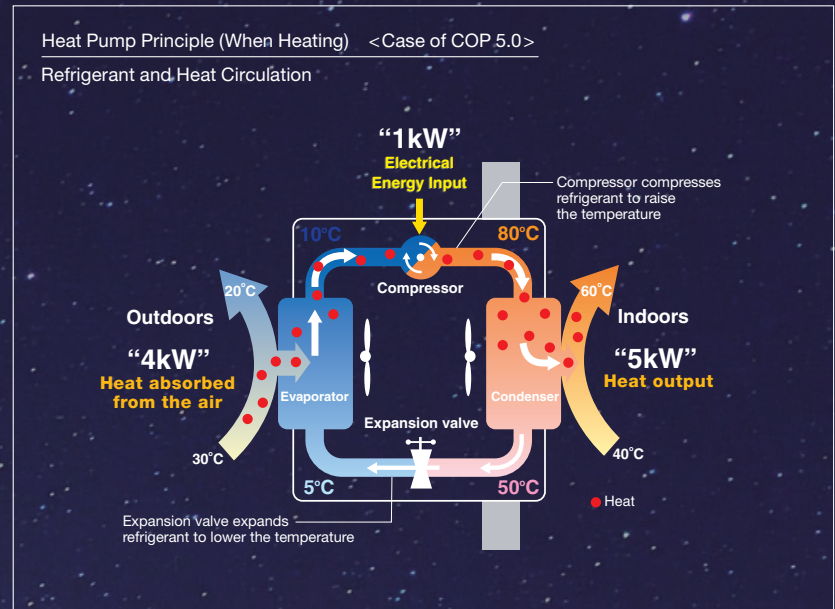

Mitsubishi Electric develops technologies to balance comfort and ecology, achieving greater efficiency in heat pump operation.

	Comfort	Ecology
1. Inverter	Faster start-up and more stable indoor temperature than non-inverter units.	Fewer On/Off operations than with non-inverter, saving energy.
2. 3D i-see Sensor	Since the positions of people can be detected, airflow can be set to personal taste, such as in airflow path or protected from the wind. The ability to adjust to individual preferences realizes more comfortable air conditioning.	Since the number of people in a room can be detected, energy-saving operation is adjusted or the power is turned off automatically. Efficient air conditioning with less waste is realized.
3. Flash Injection	Achieves high heating capacity even at low temperatures, plus faster start-up compared to conventional inverters.	Expands the region covered by heat pump heating system.

Creating a Recycling-Based Society

1. All models are designed for RoHS and WEEE compliance.*
2. Mitsubishi Electric develops downsizing technology to reduce materials use.

* WEEE and RoHS directives: The Waste Electrical and Electronic Equipment (WEEE) Directive is a recycling directive for this type of equipment, while the Restrictions of Hazardous Substances (RoHS) Directive is an EU directive restricting the use of six specified substances in electronic and electrical devices. In the EU, it is no longer possible (from July 2006) to sell products containing any of the six substances.

Ensuring Harmony with Nature / Fostering Environmental Awareness

In striving to heighten the eco-awareness of its employees, Mitsubishi Electric provides education in RoHS, WEEE and other environmental regulations, along with environmental education targeting second and third-year workers.

C

CONTENTS



Air Conditioners

■ LINE-UP	005-008
■ M SERIES	009-044
■ S SERIES	045-054
■ P SERIES	055-090
■ MULTI SPLIT SERIES	091-108
■ POWERFUL HEATING SERIES	109-126

AIR-TO-WATER

■ FEATURES & SPECIFICATIONS	127-154
-----------------------------------	---------

Air Conditioners

■ NEW ECODESIGN DIRECTIVE	155-156
■ INVERTER TECHNOLOGIES	157-158
■ COMFORT	159-162
■ CONVENIENCE	163-164
■ INSTALLATION & MAINTENANCE	165-166
■ SYSTEM CONTROL	167-168
■ CONTROL TECHNOLOGIES	169-176
■ SYSTEM CONTROL	177-178
■ FUNCTION LIST	179-184
■ OPTIONAL PARTS	185-194
■ EXTERNAL DIMENSIONS	195-210
■ PIPING INSTALLATION	211-218

M/S/P/Multi/Zubadan/ATW









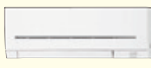
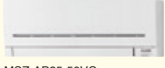

■ CONDITIONS FOR SPECIFICATION	219
■ HOW TO READ A MODEL NAME	219
■ REFRIGERANT AMOUNT	220
■ R32 REFRIGERANT	221-222

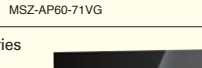
LOSSNAY SYSTEM

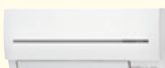
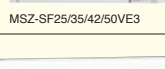
■ FEATURES & SPECIFICATIONS	223-237
-----------------------------------	---------

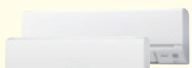
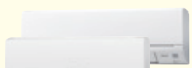
LINE-UP

M SERIES INVERTER Models

Model Name		1.5kW	1.8kW	2.0kW	2.2kW	2.5kW	3.5kW	4.2kW	5.0kW	6.0kW	7.1kW	Page	
		1-phase	1-phase	1-phase	1-phase	1-phase	1-phase	1-phase	1-phase	1-phase	1-phase		
Wall-mounted	MSZ-L Series R32 R410A *1 		WVRB Multi connection only			WVRB SINGLE	WVRB SINGLE		WVRB SINGLE	WVRB SINGLE		11	
	MSZ-AP Series R32 R410A *1 	Multi connection only		SINGLE								17	
						SINGLE _H	SINGLE _H	SINGLE _H	SINGLE _H			17	
	MSZ-AP25-50VG R32 									*2 SINGLE	*2 SINGLE	17	
	MSZ-AP60-71VG 												
	MSZ-E Series R32 R410A 		WSB Multi connection only		WSB Multi connection only		WSB SINGLE _H	WSB SINGLE _H	WSB SINGLE	WSB SINGLE			23
	MSZ-S Series R410A 	Multi connection only		Multi connection only									25
													
	MSZ-SF25/35/42/50VE3 					SINGLE _H	SINGLE _H	SINGLE _H	SINGLE _H				25
	MSZ-G Series R410A 										SINGLE	SINGLE	25
MSZ-HR Series R32 						SINGLE	SINGLE	SINGLE	SINGLE			33	
MSZ-H Series R410A 						SINGLE	SINGLE		SINGLE	SINGLE	SINGLE	31	
MSZ-HJ60/71 MSZ-HJ25/35/50 						SINGLE	SINGLE		SINGLE	SINGLE	SINGLE		
MSY-TP Series R32 							SINGLE		SINGLE			29	
Compact floor	MFZ Series R32 R410A 					SINGLE	SINGLE		SINGLE	SINGLE		35	
						SINGLE	SINGLE		SINGLE				
1-way cassette	MLZ Series R32 					SINGLE	SINGLE		SINGLE			39	

*1: R410A is for Multi connection.
*2: R32

H : Outdoor unit with freeze-prevention heater is available.
W-S-B: Indoor units are available in three colours; White, Black and Silver.
W-V-R-B: Indoor units are available in four colours; Natural White, Pearl White, Ruby Red, and Onyx Black.

Indoor Combinations

- SINGLE** 1 outdoor unit & 1 indoor unit
- TWIN** 1 outdoor unit & 2 indoor units
- TRIPLE** 1 outdoor unit & 3 indoor units
- QUADRUPLE** 1 outdoor unit & 4 indoor units

S SERIES

INVERTER Models





Model Name		1.5kW	2.5kW	3.5kW	5.0kW	6.0kW	7.1kW	10.0kW	12.5kW	14.0kW	Page
		1-phase	1-phase	1-phase	1-phase	1-phase	1-phase	1- & 3-phase	1- & 3-phase	1- & 3-phase	
2 x 2 cassette	SLZ Series R32 R410A		Multi connection only	SINGLE	SINGLE	SINGLE	SINGLE	TWIN* ^{#1}	TWIN* ^{#1} TRIPLE* ^{#1} TRIPLE* ^{#1}	TWIN* ^{#1} TRIPLE* ^{#1} QUADRUPLE* ^{#1}	47
	Compact ceiling-concealed			SINGLE* ^{#2}	SINGLE* ^{#2}	SINGLE* ^{#2}	SINGLE* ^{#2}	SINGLE* ^{#2}			

*1 Only for R410A connection

*2 Indoor units are available in two types; with or without the wireless remote controller.







P SERIES

R32 Power Inverter Models / R32 Standard Inverter Models

Model Name		3.5kW	5.0kW	6.0kW	7.1kW	10.0kW	12.5kW	14.0kW	Page
		1-phase	1-phase	1-phase	1-phase	1- & 3-phase	1- & 3-phase	1- & 3-phase	
4-way cassette	PLA Series R32		SINGLE	SINGLE	SINGLE	SINGLE TWIN	SINGLE TWIN	SINGLE TWIN TRIPLE	59
Ceiling-concealed	PEAD Series R32		SINGLE	SINGLE	SINGLE	SINGLE TWIN	SINGLE TWIN	SINGLE TWIN TRIPLE	68
Wall-mounted	PKA Series R32		SINGLE*	SINGLE*	SINGLE*	SINGLE* TWIN*	SINGLE TWIN	TWIN TRIPLE	75
Ceiling-suspended	PCA-KA Series R32		SINGLE	SINGLE	SINGLE	SINGLE TWIN	SINGLE TWIN	SINGLE TWIN TRIPLE	80

* R32 Power Inverter Model only

R410A POWER INVERTER Models / R410A STANDARD INVERTER Models











Model Name		3.5kW	5.0kW	6.0kW	7.1kW	10.0kW	12.5kW	14.0kW	20.0kW	25.0kW	Page
		1-phase	1-phase	1-phase	1-phase	1- & 3-phase	1- & 3-phase	1- & 3-phase	3-phase	3-phase	
4-way cassette	PLA Series R410A		SINGLE	SINGLE	SINGLE	SINGLE	SINGLE TWIN	SINGLE TWIN TRIPLE	TWIN TRIPLE QUADRUPLE	TWIN TRIPLE QUADRUPLE	59
Ceiling-concealed	PEAD Series R410A		SINGLE	SINGLE	SINGLE	SINGLE	SINGLE TWIN	SINGLE TWIN TRIPLE	TWIN TRIPLE QUADRUPLE	TWIN TRIPLE QUADRUPLE	68
	PEA Series R410A								SINGLE	SINGLE	73
Wall-mounted	PKA Series R410A		SINGLE*	SINGLE*	SINGLE*	SINGLE* TWIN*	SINGLE TWIN	TWIN TRIPLE	TWIN TRIPLE QUADRUPLE	TWIN TRIPLE QUADRUPLE	75
Ceiling-suspended	PCA-KA Series R410A		SINGLE	SINGLE	SINGLE	SINGLE	SINGLE TWIN	SINGLE TWIN TRIPLE	TWIN TRIPLE QUADRUPLE	TWIN TRIPLE QUADRUPLE	80
for Professional Kitchen	PCA-HA Series* R410A					SINGLE*		TWIN*		TWIN*	81
Floor-standing	PSA Series R410A					SINGLE*	SINGLE	SINGLE	SINGLE TWIN	TWIN TRIPLE	87











* Power Inverter Models only

LINE-UP

MXZ SERIES



INVERTER Models

Model Name	Capacity Class	Page
up to 2 indoor units MXZ-2F33VF(2) R32 	3.3kW <1-phase>	93
up to 2 indoor units MXZ-2F42VF(2) R32 	4.2kW <1-phase>	93
up to 2 indoor units MXZ-2F53VF(H) R32 	5.3kW <1-phase>	93
up to 3 indoor units MXZ-3F54VF(2) R32 	5.4kW <1-phase>	93
up to 3 indoor units MXZ-3F68VF(2) R32 	6.8kW <1-phase>	93
up to 4 indoor units MXZ-4F72VF(2) R32 	7.2kW <1-phase>	93
up to 4 indoor units MXZ-4F80VF2 R32 	8.0kW <1-phase>	93
up to 2 indoor units MXZ-2HA40VF R32 	4.0kW <1-phase>	97
up to 2 indoor units MXZ-2HA50VF R32 	5.0kW <1-phase>	97
up to 3 indoor units MXZ-3HA50VF R32 	5.0kW <1-phase>	97

Model Name	Capacity Class	Page
up to 2 indoor units MXZ-2D33VA R410A 	3.3kW <1-phase>	95
up to 2 indoor units MXZ-2D42VA2 R410A 	4.2kW <1-phase>	95
up to 2 indoor units MXZ-2D53VA (H)2 R410A 	5.3kW <1-phase>	95
up to 3 indoor units MXZ-3E54VA R410A 	5.4kW <1-phase>	95
up to 3 indoor units MXZ-3E68VA R410A 	6.8kW <1-phase>	95
up to 4 indoor units MXZ-4E72VA R410A 	7.2kW <1-phase>	95
up to 4 indoor units MXZ-4E83VA R410A 	8.3kW <1-phase>	95
up to 5 indoor units MXZ-5E102VA R410A 	10.2kW <1-phase>	95
up to 6 indoor units MXZ-6D122VA R410A 	12.2kW <1-phase>	95
up to 2 indoor units MXZ-2DM40VA R410A 	4.0kW <1-phase>	99
up to 3 indoor units MXZ-3DM50VA R410A 	5.0kW <1-phase>	99

PUMY SERIES

INVERTER Models

Model Name	12.5kW	14.0kW	15.5kW	22.4kW	Page
	1 & 3-phase	1 & 3-phase	1 & 3-phase	3-phase	
PUMY-SP R410A 	✓	✓	✓		101
PUMY-P R410A 	✓	✓	✓	✓	103

Indoor Combinations

- SINGLE** 1 outdoor unit & 1 indoor unit
- TWIN** 1 outdoor unit & 2 indoor units
- TRIPLE** 1 outdoor unit & 3 indoor units
- QUADRUPLE** 1 outdoor unit & 4 indoor units

POWERFUL HEATING SERIES

INVERTER Models

Model Name		Image	2.5kW	3.5kW	5.0kW	5.3kW	8.3kW	10.0kW	12.5kW	Page
			1-phase	1-phase	1-phase	1-phase	1-phase	1- & 3-phase	3-phase	
Wall-mounted	MSZ-LVGHZ Series R32 R410A *		SINGLE H	SINGLE H	SINGLE H					111
	MSZ-FVEHZ Series R410A		SINGLE H	SINGLE H	SINGLE H					111
Compact floor		MFZ VEHZ Series R410A		SINGLE H	SINGLE H	SINGLE H				115
ZUBADAN 	4-way cassette	PLA Series R32 R410A						SINGLE TWIN	SINGLE TWIN	118
	Ceiling-concealed	PEAD Series R32 R410A						SINGLE TWIN	SINGLE TWIN	120
	Wall-mounted	PKA Series R32 R410A						SINGLE TWIN		121
Multi split		MXZ-E VAHZ Series R410A					2PORT H 4PORT H			122

* R410A is for Multi connection.

H: Freeze-prevention heater is included as standard equipment.

AIR TO WATER SERIES

INDOOR UNIT

Hydro box, cylinder unit



Reversible hydro box, Reversible cylinder unit



OUTDOOR UNIT

Packaged type	Small capacity (Under 5kW)*	Medium capacity (7.5kW-14kW)*	Large capacity (≥16kW)*
		Coming soon 	
Split type	Small capacity (Under 5kW)*	Medium capacity (7.5kW-14kW)*	Large capacity (≥16kW)*
		NEW 	
		NEW 	
Eco Inverter			
ATA/ATW Hybrid system	Small capacity (Under 5kW)*	Medium capacity (7.5kW-14kW)*	Large capacity (≥16kW)*
Mr.SLIM+			
PUMY + ecodan			

*Rated capacity is at conditions A2W35. (according to EN14511)









M

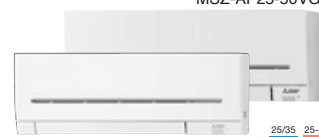

SERIES



SELECTION

Choose the model that best matches room conditions.

SELECT SERIES		
A multiple series line-up to choose from, each with various outstanding features. In addition to inverter-equipped models, constant-speed, floor-standing and cassette models can be selected. Choose the best series to match usage needs.		
Wall-mounted Units		
MSZ-L SERIES R32 R410A *1  25/35/50 25/35 25/35 SEER A+++ SCOP A+++ MXZ connection	MSZ-A SERIES R32 R410A *1 MSZ-AP25-50VG  MSZ-AP15-20VF 25/35 25-50 SEER A+++ SCOP A++ MXZ connection	MSZ-E SERIES R32 R410A *1  25/35 25/35 SEER A+++ SCOP A++ MXZ connection
MSZ-S SERIES R410A MSZ-SF25-50VE  MSZ-SF15/20VA SEER A++ SCOP A+ MXZ connection	MSZ-G SERIES R410A  SEER A++ SCOP A+ MXZ connection	MSZ-HR SERIES R32  SEER A++ SCOP A+ MXZ connection
MSZ-H SERIES R410A MSZ-HJ60/71  MSZ-HJ25/35/50 50/60/71 50/60/71 SEER A SCOP A MXZ connection	MSY-TP SERIES R32  35 SEER A+++	
Floor-standing	Cassette Units	
MFZ SERIES R410A  25 SEER A+++ SCOP A+ MXZ connection	MLZ SERIES R32  MXZ connection	SEER A SCOP A Energy Rank MXZ connection Compatible for connection to MXZ Series system R32 R32 Refrigerant R410A R410A Refrigerant *1 R410 is for multi connection.

SELECT OUTDOOR UNIT		
Some outdoor units in the line-up have heaters for use in cold regions. Units with an "H" in the model name are equipped with heaters.		
Heater Installed MUZ-AP25/35/42/50VGH MUZ-EF25/35VGH MUZ-SF25/35/42/50VEH	Hyper Heating MUZ-LN25/35/50VGHZ MUZ-FH25/35/50VEHZ MUZ-KJ25/35/50VEHZ	Selecting a Heater-equipped Model In regions with the following conditions, there is a possibility that water resulting from condensation on the outdoor unit when operating in the heating mode will freeze and not drain from the base. 1) Cold outdoor temperatures (temperature does not rise above 0°C all day) 2) Areas where dew forms easily (in the mountains, valleys (surrounded by mountains), near a forest, near unfrozen lakes, ponds, rivers or hot springs), or areas with snowfall. To prevent water from freezing in the base, it is recommended that a unit with a built-in heater be purchased. Please ask your dealer representative about the best model for you.
 MUZ-LN25/35VG	 MUZ-LN50VG	

MSZ-L SERIES

R32
Single / Multi

R410A
Multi

MSZ-LN18/25/35/50/60VGR



GOOD DESIGN AWARD 2016
BEST 100



Developed to complement modern interior room décor, the LN Series is available in four colours specially chosen to blend in naturally wherever installed. Not only the sophisticated design, but also the optimum energy efficiency and operational comfort add even more value to this series.

Luminous and Luxurious Design

Natural White, Pearl White, Ruby Red, and Onyx Black. LN Series indoor units are available in four colours to match various lifestyles. The appearance of the indoor unit differs depending on the lighting in the room, attracting the attention of everyone that enters the room.

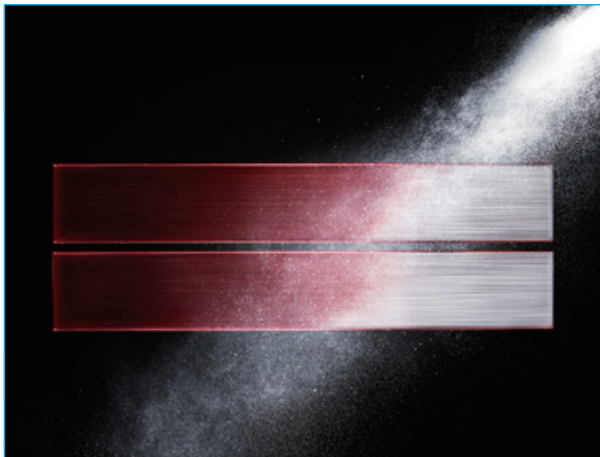

Master craftsmanship painting technology has resulted in a refined design, giving the finish deep colour and a premium quality feel.



Pearl White blends in with any interior.



Ruby Red gives an accent to the room, affording timeless elegance to sophisticated interiors.

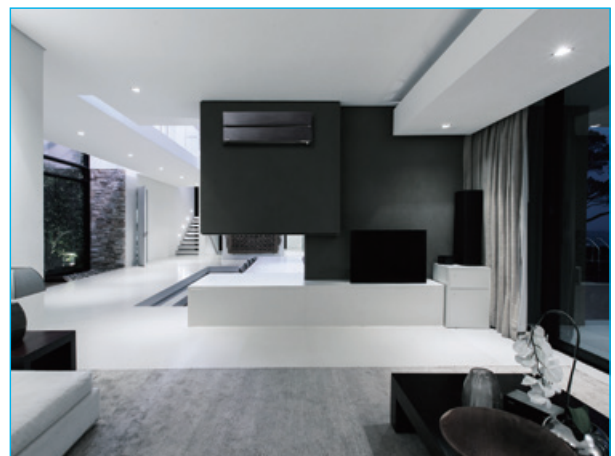

Onyx Black matches darker interiors, creating a comfortable environment.

Not only the indoor units, but the wireless remote controllers come in four colours as well. Each remote controller matches the indoor unit. Even the textures are the same.



Pearl White



Ruby Red



Onyx Black



Natural White

High Energy Efficiency



Optimum cooling/heating performance is another feature for the LN series. Models from capacities 25 to 50 have achieved the "Rank A+++" for SEER, and models for capacities 25 and 35 have achieved the "Rank A+++" for SCOP as well.

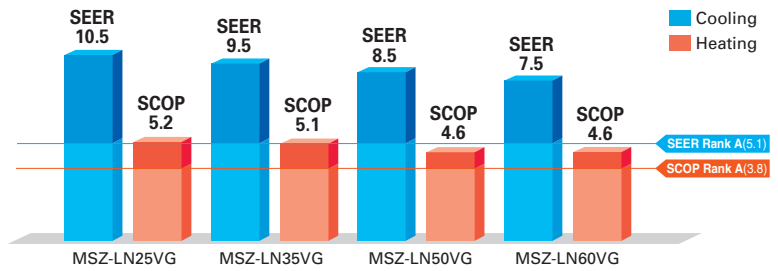

3D i-see Sensor

The LN Series is equipped with 3D i-see Sensor, an infrared-ray sensor that measures the temperature at distant positions. While moving to the left and right, eight vertically arranged sensor elements analyze the room temperature in three dimensions. This detailed analysis makes it possible to judge where people are in the room, thus allowing creation of features such as "Indirect airflow," to avoid airflow hitting people directly, and "direct airflow" to deliver airflow to where people are.

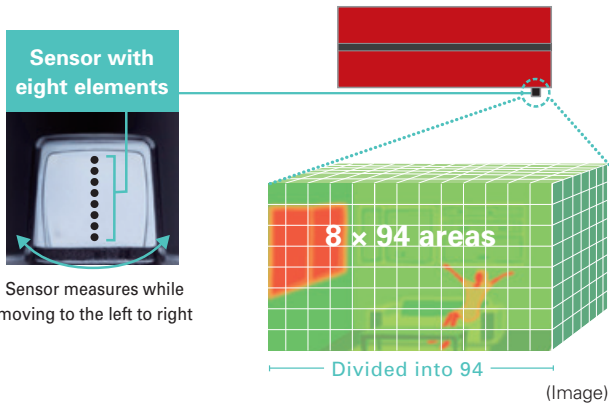

No occupancy energy-saving mode

The sensors detect whether there are people in the room. When no-one is in the room, the unit automatically switches to energy-saving mode.

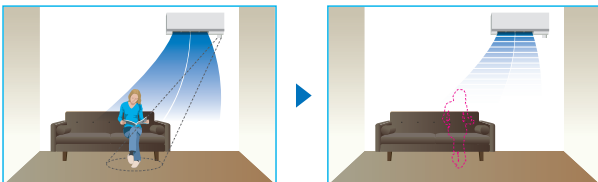

The "3D i-see Sensor" detects people's absence and the power consumption is automatically reduced approximately 10% after 10 minutes and 20% after 60 minutes.

Indirect Airflow

The indirect airflow setting can be used when the flow of air feels too strong or direct. For example, it can be used during cooling to avert airflow and prevent body temperature from becoming excessively cooled.

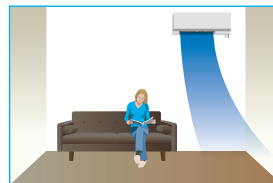

Direct Airflow

This setting can be used to directly target airflow at people such as for immediate comfort when coming indoors on a hot (cold) day.

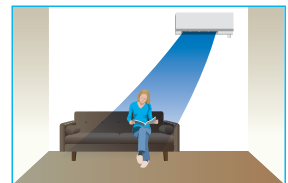

Even Airflow *LN Series only

Normal swing mode

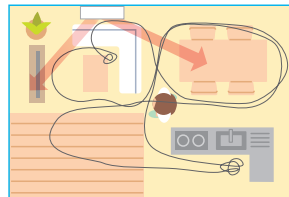

Even airflow mode

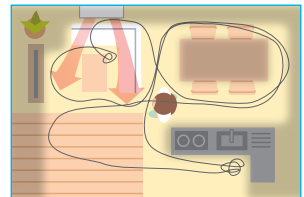

The airflow is distributed equally throughout the room, even to spaces where there is no human movement.

The 3D i-see sensor memorizes human movement and furniture positions, and efficiently distributes airflow.

No occupancy Auto-OFF mode *LN Series only

The sensors detect whether or not there are people in the room. When there is no one in the room, the unit turns off automatically.

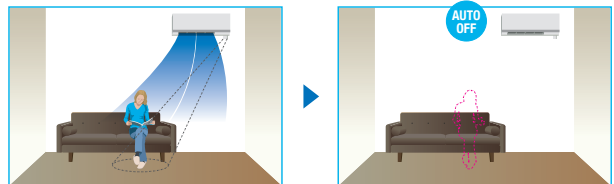

R32 Refrigerant

The new R32 refrigerant has a global warming potential approximately 1/3*1 that of our current refrigerant, R410A; thereby dramatically reducing the negative impact more than ever. Actively introducing the new R32 refrigerant to suppress global warming, Mitsubishi Electric continues to promote manufacturing while considering the environment.

Comparison of Global Warming Potential

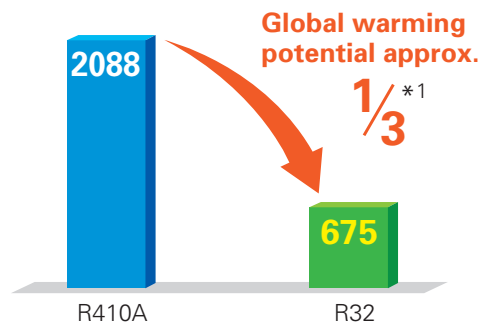

*1: Source: IPCC 4th Assessment Report, global warming potential (GWP) 100-year value. Comparison of 2088(R410A) and 675 (R32).

Plasma Quad Plus

Plasma Quad Plus is a plasma-based filter system that effectively removes six kinds of air pollutants. Plasma Quad Plus captures mold and allergens more effectively than Plasma Quad. It can also capture PM2.5 and particles smaller than 2.5µm, creating healthy living spaces for all.

Bacteria

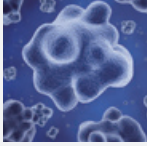

Test results have confirmed that Plasma Quad Plus neutralizes 99% of bacteria in 162 minutes in a 25m³ test space.

<Test No.> KRCEs-Bio. Test Report No. 2016-0118

Viruses

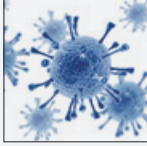

Test results have confirmed that Plasma Quad Plus neutralizes 99% of virus particles in 72 minutes in a 25m³ test space.

<Test No.> vrc.center, SMC No. 28-002

Molds

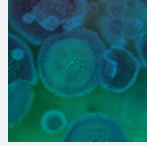

Test results have confirmed that Plasma Quad Plus neutralizes 99% of mold in 135 minutes in a 25m³ test space.

<Test No.> Japan Food Research Laboratories Test Report No. 16069353001-0201

Allergens

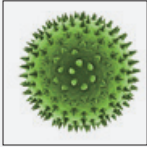

In a test, air containing cat fur and pollen was passed through the air cleaning device at the low airflow setting. Before and after measurements confirm that Plasma Quad Plus neutralizes 98% of cat fur and pollen.

<Test No.> ITEA Report No. T1606028

PM2.5



Test results have confirmed that Plasma Quad Plus removes 99% of PM2.5 in 145 minutes in a 28m³ test space.

<In-company investigation>

Dust

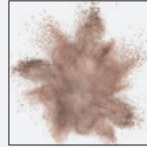

Test results have confirmed that Plasma Quad Plus removes 99.7% of dust and mites.

<Test No.> ITEA Report No. T1606028

Model	Name	Method	Bacteria	Viruses	Molds	Allergens	Dust	PM2.5*
FH Series	Plasma Quad	One-Stage Plasma	A	A	B	B	C	
LN Series	Plasma Quad Plus	Two-Stage Plasma	A	A	A	A	A	A

A: Highly effective
B: Effective
C: Partially effective

*PM2.5:
Particles smaller than 2.5µm



Image of Plasma Quad Plus

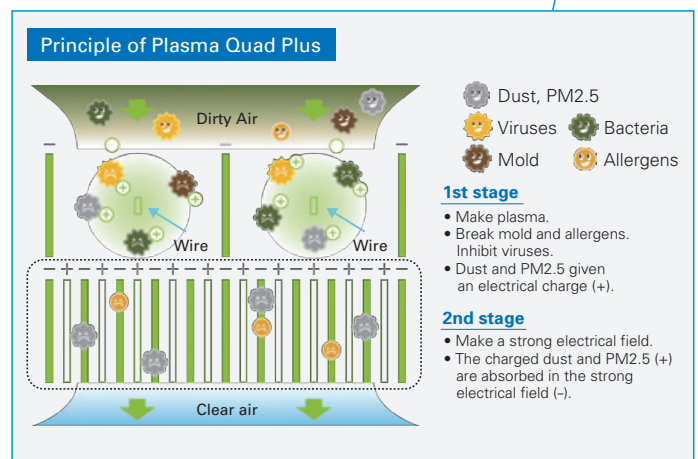
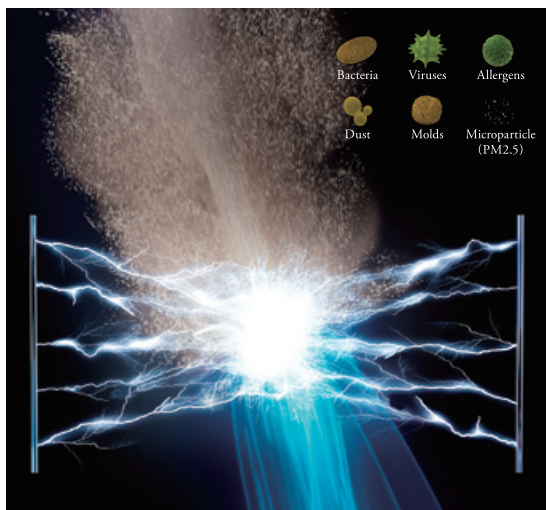



Dual Barrier Coating

A two-barrier coating prevents dust and greasy dirt from getting into the air conditioner.

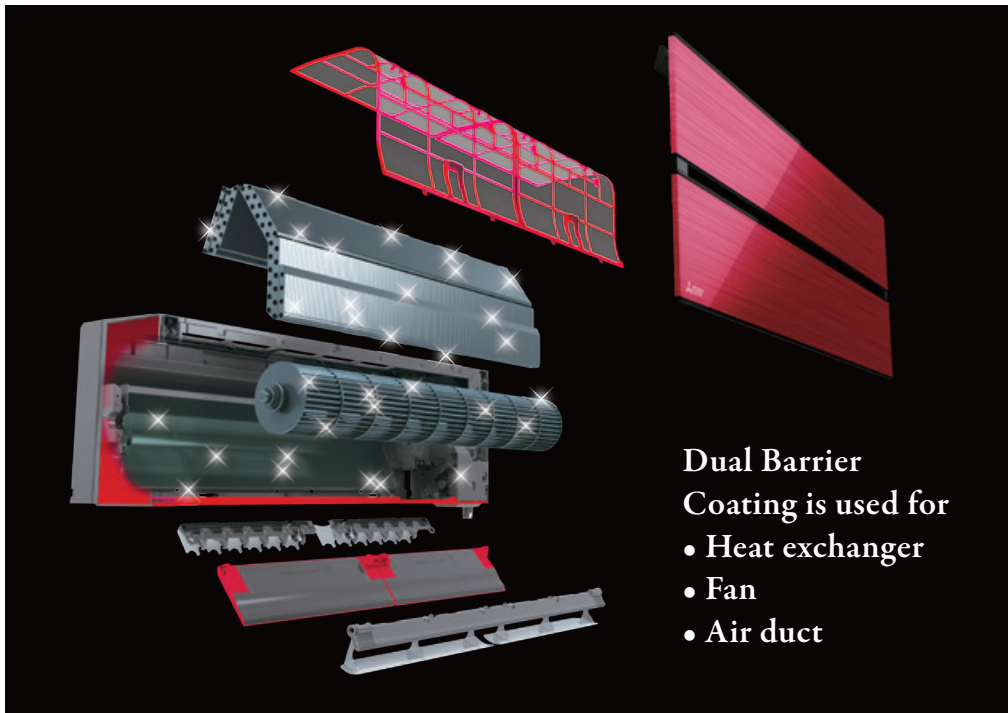

State-of-the-art coating technology

Dirt is generally classified into two groups: hydrophilic dirt such as fiber dust and sand dust, and hydrophobic dirt such as oil and cigarette smoke. Mitsubishi Electric's dual barrier coating works as a two-barrier coating with blended "fluorine particles" that prevent hydrophilic dirt penetration and "hydrophilic particles" that prevent hydrophobic dirt from getting into the air conditioner. This dual coating on the inner surface keeps the air conditioner clean year-round.

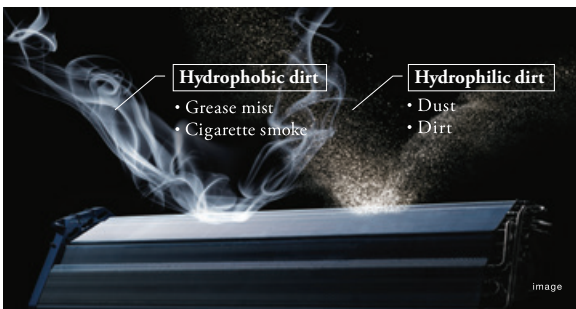

Comparison of dirt on heat exchanger, fan and air duct (in-house comparison)

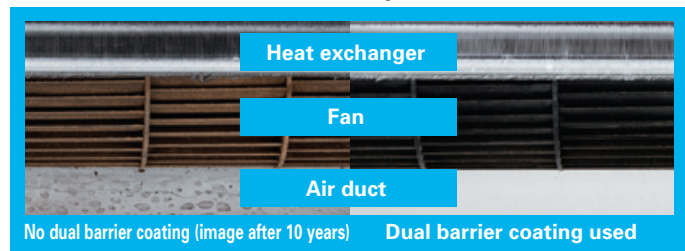

The inside of the indoor unit gets dirty after many years of usage.

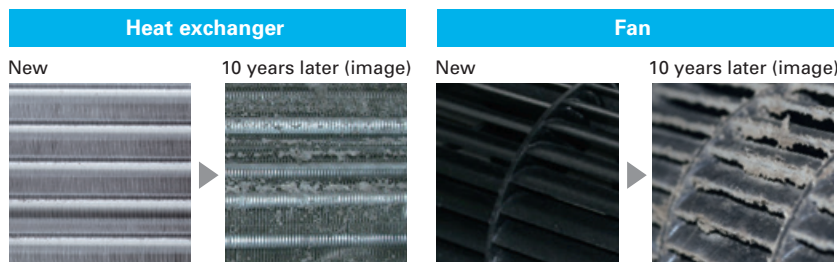

Consequences when the inside of the indoor unit is left dirty.

- Deterioration in energy efficiency.
- Musty smell from the unit.

Double Flap

The vanes create various airflows to make each person in the room comfortable. Not only the horizontal vanes, but also the vertical vanes move independently, eliminating hot spots or cold spots throughout the room.



Night Mode

When Night Mode is activated using the wireless remote controller, air conditioner operation will switch to the following settings.

- The brightness of the operation indicator lamp will become dimmer.
- The beeping sound will be disabled.
- The outdoor operating noise will drop to 3dB lower than the rated operating noise specification.

*The cooling/heating capacity may drop.

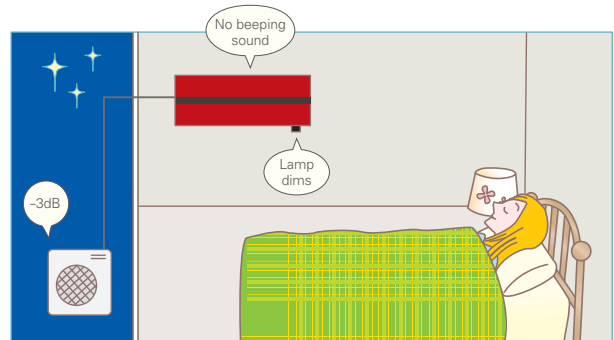

10°C Heating

During heating operation, the temperature can be set in 1°C increments down to 10°C.

This function can also be used with the Weekly Timer setting.

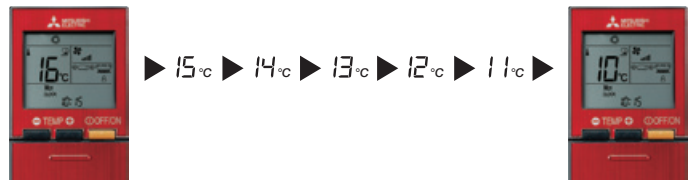

Quiet Operation

The indoor unit noise level is as low as 19dB for LN25/35 models, offering a peaceful inside environment.

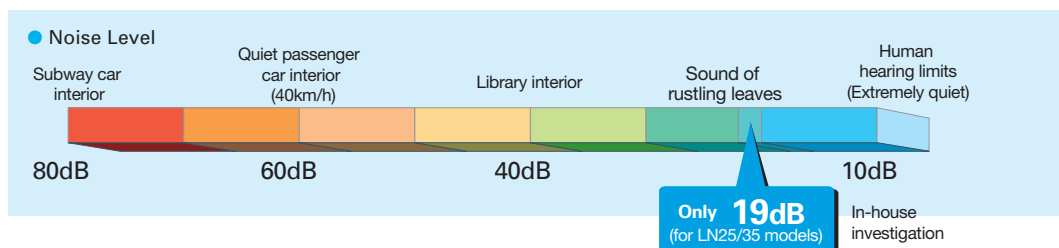

Built-in Wi-Fi Interface

The indoor unit is equipped with a Wi-Fi Interface inside an exclusive pocket in the unit.

This eliminates the need to install a Wi-Fi interface, and also contributes to the beautiful appearance since the interface is hidden.

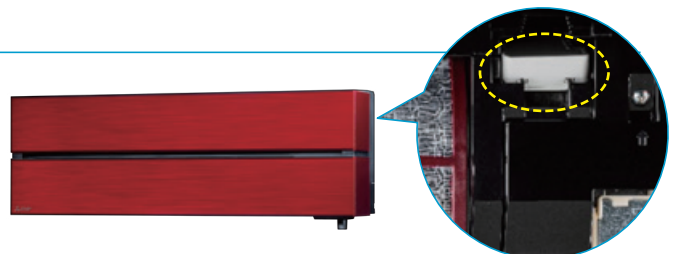

MSZ-L SERIES



Indoor Unit / Remote Controller

R32

R410A



GOOD DESIGN AWARD 2016
BEST 100

Outdoor Unit

R32

<Pearl White>



MSZ-LN18/25/35/50/60VGW

<Ruby Red>



MSZ-LN18/25/35/50/60VGR

<Natural White>



MSZ-LN18/25/35/50/60VGW

<Onyx Black>



MSZ-LN18/25/35/50/60VGB



MUZ-LN25/35VG



MUZ-LN50VG



MUZ-LN60VG



Type			Inverter Heat Pump					
Indoor Unit			MSZ-LN18VG (W) (V) (R) (E)	MSZ-LN25VG (W) (V) (R) (E)	MSZ-LN35VG (W) (V) (R) (E)	MSZ-LN50VG (W) (V) (R) (E)	MSZ-LN60VG (W) (V) (R) (E)	
Outdoor Unit			for MXZ connection	MUZ-LN25VG	MUZ-LN35VG	MUZ-LN50VG	MUZ-LN60VG	
Refrigerant			Single: R32 ⁽¹⁾ / Multi: R410A or R32 ⁽¹⁾					
Power Source			Outdoor Power Supply					
Supply	Outdoor (V / Phase / Hz)		230 / Single / 50					
Cooling	Design load	kW	–	2.5	3.5	5.0	6.1	
	Annual electricity consumption ⁽²⁾	kWh/a	–	83	128	205	285	
	SEER ⁽⁴⁾	–	–	10.5	9.5	8.5	7.5	
	Capacity	Energy efficiency class		–	A+++	A+++	A+++	A++
		Rated	kW	–	2.5	3.5	5.0	6.1
Heating (Average Season) ⁽⁵⁾	Design load	kW	–	3.0(-10°C)	3.6(-10°C)	4.5(-10°C)	6.0(-10°C)	
	Declared Capacity	at reference design temperature	kW	–	3.0(-10°C)	3.6(-10°C)	4.5(-10°C)	6.0(-10°C)
		at bivalent temperature	kW	–	3.0(-10°C)	3.6(-10°C)	4.5(-10°C)	6.0(-10°C)
	at operation limit temperature	kW	–	2.5(-15°C)	3.2(-15°C)	4.2(-15°C)	6.0(-15°C)	
	Back up heating capacity	kW	–	0.0(-10°C)	0.0(-10°C)	0.0(-10°C)	0.0(-10°C)	
Annual electricity consumption ⁽²⁾	kWh/a	–	794	974	1369	1826		
SCOP ⁽⁴⁾	–	–	–	5.2	5.1	4.6	4.6	
Operating Current (Max)	Energy efficiency class		–	A+++	A+++	A++	A++	
	Rated	kW	–	3.2	4.0	6.0	6.8	
	Min-Max	kW	–	0.8 - 5.4	1.0 - 6.3	1.0 - 8.2	1.8 - 9.3	
	Total Input	kW	–	0.580	0.800	1.480	1.810	
	Rated	kW	–	–	7.1	9.9	13.9	15.2
Indoor Unit	Input	kW	0.029	0.029	0.029	0.034	0.040	
	Operating Current(Max)	A	0.3	0.3	0.3	0.4	0.4	
	Dimensions	H*W*D	mm	307-890-233	307-890-233	307-890-233	307-890-233	
	Weight	kg	–	15.5	15.5	15.5	15.5	
	Air Volume (SLo-Lo-Mid-Hi-SH ⁽³⁾ (Dry/Wet))	Cooling	m ³ /min	4.3 - 5.8 - 7.1 - 8.8 - 11.9	4.3 - 5.8 - 7.1 - 8.8 - 11.9	4.3 - 5.8 - 7.1 - 8.8 - 12.8	5.7 - 7.6 - 8.8 - 10.6 - 13.9	7.1 - 8.8 - 10.6 - 12.7 - 15.7
		Heating	m ³ /min	4.0 - 5.7 - 7.1 - 8.5 - 14.4	4.0 - 5.7 - 7.1 - 8.5 - 14.4	4.3 - 5.7 - 7.1 - 8.5 - 13.7	5.4 - 6.4 - 8.5 - 10.7 - 15.7	6.6 - 9.5 - 11.5 - 13.6 - 15.7
	Sound Level (SPL) (SLo-Lo-Mid-Hi-SH ⁽³⁾)	Cooling	dB(A)	19 - 23 - 29 - 36 - 42	19 - 23 - 29 - 36 - 42	19 - 24 - 29 - 36 - 43	27 - 31 - 35 - 39 - 46	29 - 37 - 41 - 45 - 49
		Heating	dB(A)	19 - 24 - 29 - 36 - 45	19 - 24 - 29 - 36 - 45	19 - 24 - 29 - 36 - 45	25 - 29 - 34 - 39 - 47	29 - 37 - 41 - 45 - 49
	Sound Level (PWL)	Cooling	dB(A)	–	58	58	60	65
		Heating	dB(A)	–	58	58	60	65
Dimensions	H*W*D	mm	–	550-800-285	550-800-285	714-800-285	880-840-330	
Outdoor Unit	Weight	kg	–	35	40	55	55	
	Air Volume	Cooling	m ³ /min	–	31.4	31.4	40.0	50.1
		Heating	m ³ /min	–	26.6	31.4	40.5	51.3
	Sound Level (SPL)	Cooling	dB(A)	–	46	49	51	55
		Heating	dB(A)	–	49	50	54	55
	Sound Level (PWL)	Cooling	dB(A)	–	60	61	64	65
		Heating	dB(A)	–	60	61	64	65
	Operating Current (Max)	A	–	6.8	9.6	13.5	14.8	
	Breaker Size	A	–	10	10	16	16	
	Ext. Piping	Diameter	Liquid/Gas	mm	–	6.35/9.52	6.35/9.52	6.35/12.7
Max.Length		Out-In	m	–	20	20	30	
Max.Height		Out-In	m	–	12	12	15	
Guaranteed Operating Range (Outdoor)	Cooling	°C	–	-10 ~ +46	-10 ~ +46	-10 ~ +46	-10 ~ +46	
	Heating	°C	–	-15 ~ +24	-15 ~ +24	-15 ~ +24	-15 ~ +24	

(1) Refrigerant leakage contributes to climate change. Refrigerant with lower global warming potential (GWP) would contribute less to global warming than a refrigerant with higher GWP, if leaked to the atmosphere. This appliance contains a refrigerant fluid with a GWP equal to 550. This means that if 1 kg of this refrigerant fluid would be leaked to the atmosphere, the impact on global warming would be 550 times higher than 1 kg of CO₂ over a period of 100 years. Never try to interfere with the refrigerant circuit yourself or disassemble the product yourself and always ask a professional.

The GWP of R32 is 675 in the IPCC 4th Assessment Report.

(2) Energy consumption based on standard test results. Actual energy consumption will depend on how the appliance is used and where it is located.

(3) SHi: Super High

(4) SEER, SCOP and other related description are based on COMMISSION DELEGATED REGULATION (EU) No.626/2011. The temperature conditions for calculating SCOP are based on "Average Season".

(5) Please see page 00 for heating (warmer season) specifications.

MSZ-A SERIES

Introducing a compact and stylish indoor unit with various capacity, designed to match number of rooms. High performance indoor and outdoor units enabled to achieve "Rank A+++" for SEER. *MSZ-AP25/35VG



MSZ-AP15/20VG



MSZ-AP25/35/42/50VG
MSZ-AP60/71VG



High energy saving



All models in the series, from the low-capacity 25 to the high-capacity 50, have achieved either the "Rank A+++" or "Rank A++" for SEER and SCOP as energy-savings rating. Our air conditioners are contributing to reduce energy consumption in a wide range.

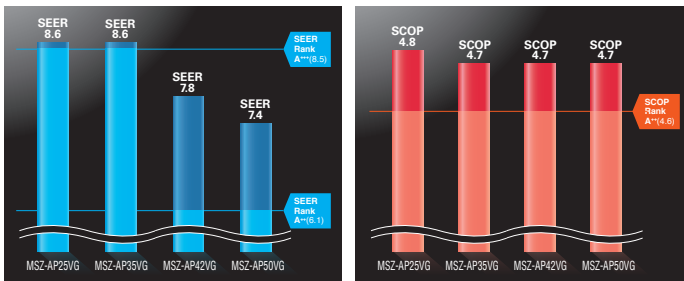

Compact and stylish

15/20 class are for multi-systems and 25-50 class are introduced as single-split and multi-systems. From small rooms to living rooms, it is possible to coordinate residences with a unified design.

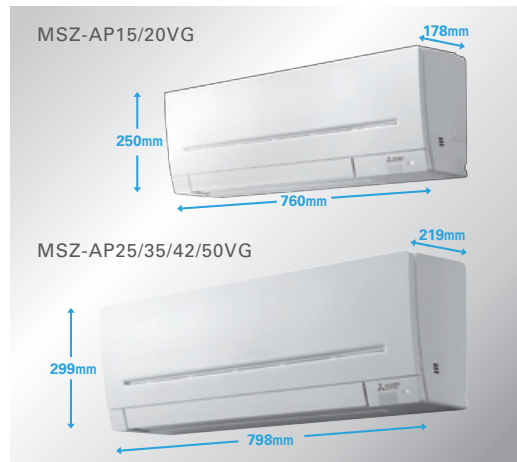

Evolved comfortable convenience function

Horizontal Airflow



The new airflow control which spreads across the ceiling eliminates the uncomfortable drafty feeling.

Auto Vane Control

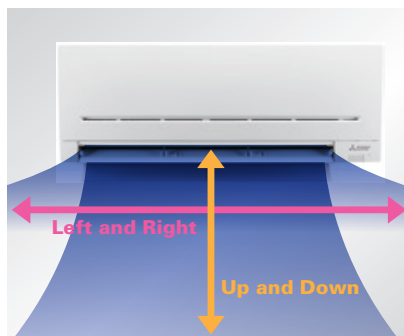

Auto vanes can be moved left and right, and up and down using the remote controller.

The Function



*Only for 25/35/42/50 models.

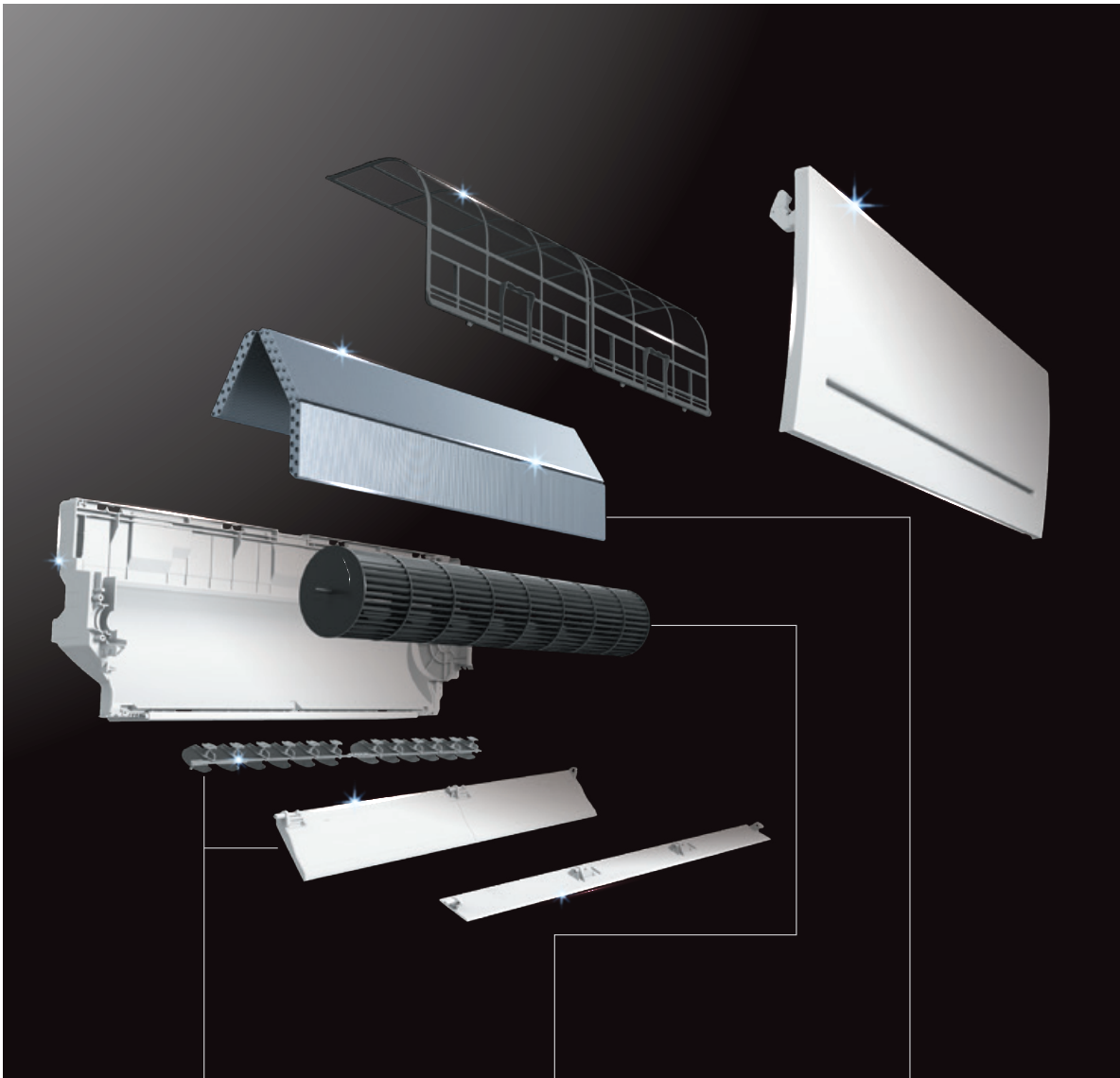

Comfort

Vertical and Horizontal Vane

New vertical and horizontal vanes are double the size of the previous model, improving airflow control elaborately.

175% larger
204% larger

High Performance

Line Flow Fan

New line flow Fan is 122% larger and 108% wider than the previous model, leading to higher aerodynamic performance. Also, same sound level as the previous model.

122% larger
108% larger

High Performance

Heat Exchanger

New ø5 Heat exchanger enables to realise 32% thinner depth than the previous model. It realises low pressure loss leading to high performance.

32% Thinner

“Weekly Timer”



Easily set desired temperatures and operation start/stop times to match lifestyle patterns. Reduce wasted energy consumption by using the timer to prevent forgetting to turn off the unit and eliminate temperature setting adjustments.

■ Example Operation Pattern (Winter/Heating mode)

	Mon.	Tues.	Wed.	Thurs.	Fri.	Sat.	Sun.
6:00	ON 20°C	ON 20°C	ON 20°C	ON 20°C	ON 20°C	ON 20°C	ON 20°C
8:00	Automatically changes to high-power operation at wake-up time						
10:00	OFF	OFF	OFF	OFF	OFF	ON 18°C	ON 18°C
12:00	Automatically turned off during work hours					Midday is warmer, so the temperature is set lower	
14:00							
16:00							
18:00	ON 20°C	ON 20°C	ON 20°C	ON 20°C	ON 20°C	ON 20°C	ON 20°C
20:00	Automatically turns on, synchronized with arrival at home					Automatically raises temperature setting to match time when outside-air temperature is low	
22:00							
(during sleeping hours)	ON 18°C	ON 18°C	ON 18°C	ON 18°C	ON 18°C	ON 18°C	ON 18°C
	Automatically lowers temperature at bedtime for energy-saving operation at night						

Settings

Pattern Settings: Input up to four settings for each day

Settings: •Start/Stop operation •Temperature setting *The operation mode cannot be set.

■ Easy set-up using dedicated buttons



The remote controller is equipped with buttons that are used exclusively for setting the Weekly Timer. Setting operation patterns is easy and quick.

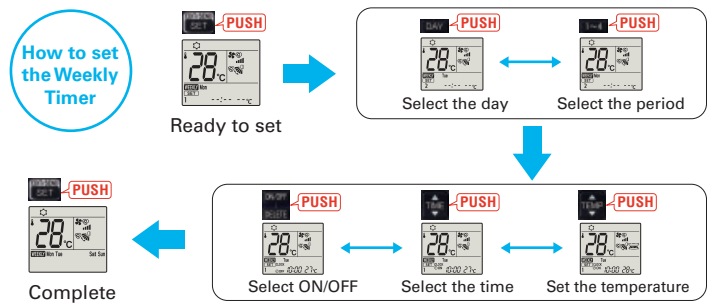

- Start by pushing the “SET” button and follow the instructions to set the desired patterns. Once all of the desired patterns are input, point the top end of the remote controller at the indoor unit and push the “SET” button one more time. (Push the “SET” button only after inputting all of the desired patterns into the remote controller memory. Pushing the “CANCEL” button will end the set-up process without sending the operation patterns to the indoor unit).
- It takes a few seconds to transmit the Weekly Timer operation patterns to the indoor unit. Please continue to point the remote controller at the indoor unit until all data has been sent.
- When “Weekly Timer” is set, temperature can not be set 10°C. (only for 15/20 models)

Low Standby Power

Electrical devices consume standby power even when they are not in actual use. While we obviously strive to reduce power consumption during actual use, reducing this wasted power that cannot be seen is also very important.

without
“Low standby power”

around 10W

with
“Low standby power”

below 1W

around 90%
reduction

Air Purifying Filter

(MSZ-AP25/35/42/50)



This filter generates stable antibacterial and deodorising effects. The size of the three-dimensional surface has been increased as well, enlarging the filter capture area. These features give the Air Purifying Filter better dust collection performance than conventional filters. The superior air-cleaning effectiveness raises room comfort yet another level.

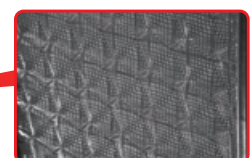
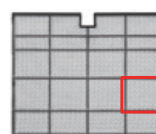

* It is okay to wash the filter with water (air-cleaning effect is maintained)

3D surface (Waved surface)

“i save” Mode



“i save” is a simplified setting function that recalls the preferred (pre-set) temperature by pressing a single button on the remote controller. Press the same button twice in repetition to immediately return to the previous temperature setting. Using this function contributes to comfortable, waste-free operation, realising the most suitable air conditioning settings and saving on power consumption when, for example, leaving the room or going to bed.

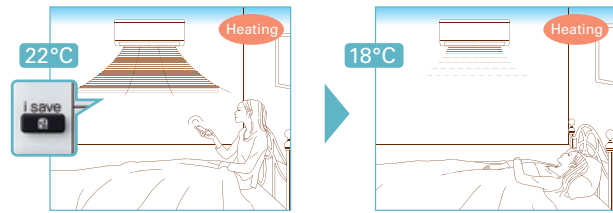

* Temperature can be preset to 10°C when heating in the “i-save” mode. (only for 15/20 models)

Outdoor Units for Cold Region

(MSZ-AP20/25/35/42/50/60/71)

Single split-type outdoor units are available in both standard and heater-equipped units. An electric heater is installed in each unit to prevent freezing in cold outdoor environments.

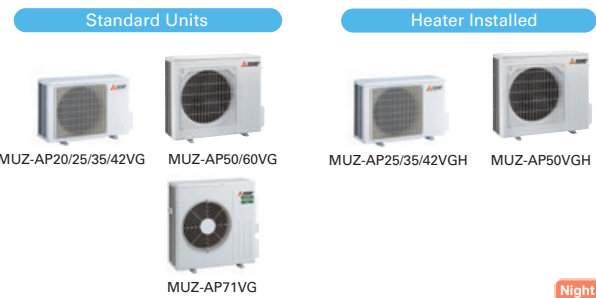

(MSZ-AP15/20/25/35/42/50/60/71)



Night Mode

When Night Mode is activated using the wireless remote controller, air conditioner operation will switch to the following settings.

- The brightness of the operation indicator lamp will become dimmer.
- The beeping sound will be disabled.
- The outdoor operating noise will drop to 3dB lower than the rated operating noise specification.

*The cooling/heating capacity may drop.

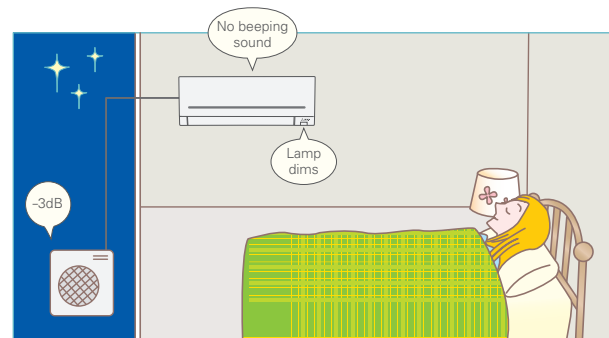

Quiet Operation

The indoor unit noise level is as low as 19dB for AP Series, offering a peaceful inside environment.

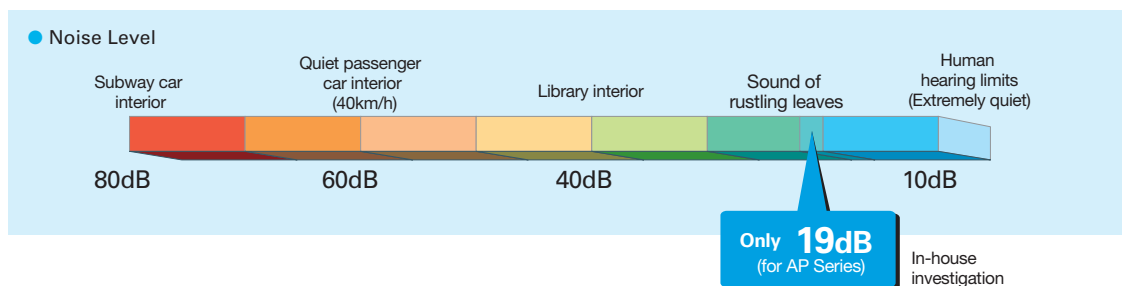

Built-in Wi-Fi Interface

(MSZ-AP25/35/42/50/60/71VGK)



The indoor unit is equipped with a Wi-Fi Interface inside an exclusive pocket in the unit.

This eliminates the need to install a Wi-Fi interface, and also contributes to the beautiful appearance since the interface is hidden.

MSZ-AP SERIES



Indoor Unit

R32 R410A



MSZ-AP25/35/42/50VG(K)

*VGK model Wi-Fi Interface built-in.



GOOD DESIGN reddot award 2018 winner



MSZ-AP60/71VG(K)

R32

*VGK model Wi-Fi Interface built-in.

Outdoor Unit

R32



MUZ-AP25/35/42VG(H)



MUZ-AP50VG(H)
MUZ-AP60VG



MUZ-AP71VG

Remote Controller



Type	Inverter Heat Pump									
Indoor Unit	MSZ-AP42VG (K)	MSZ-AP42VG (K)	MSZ-AP50VG (K)	MSZ-AP50VG (K)	MSZ-AP60VG (K)	MSZ-AP71VG (K)				
Outdoor Unit	MUZ-AP42VG	MUZ-AP42VGH	MUZ-AP50VG	MUZ-AP50VGH	MUZ-AP60VG	MUZ-AP71VG				
Refrigerant	Single: R32(*1) / Multi: R410A or R32(*1)									
Power Supply	Outdoor Power supply									
Source	230/Single/50									
Cooling	Design load	kW	4.2	4.2	5.0	5.0	6.1	7.1		
	Annual electricity consumption ^{(*)2}	kWh/a	188	188	236	236	288	345		
	SEER ^{(*)3}		7.8	7.8	7.4	7.4	7.4	7.2		
	Energy efficiency class	Rated		A++	A++	A++	A++	A++	A++	
		Capacity	kW	4.2	4.2	5.0	5.0	6.1	7.1	
	Total Input	Rated	kW	1.300	1.300	1.550	1.550	1.590	2.010	
Heating (Average Season) ^{(*)4}	Design load	kW	3.8 (-10°C)	3.8 (-10°C)	4.2 (-10°C)	4.2 (-10°C)	4.6 (-10°C)	6.7 - 10		
	Declared Capacity	at reference design temperature	kW	3.8 (-10°C)	3.8 (-10°C)	4.2 (-10°C)	4.2 (-10°C)	4.6 (-10°C)	6.7 - 10	
		at bivalent temperature	kW	3.8 (-10°C)	3.8 (-10°C)	4.2 (-10°C)	4.2 (-10°C)	4.6 (-10°C)	6.7 - 10	
		at operation limit temperature	kW	4.2 (-15°C)	3.8 (-20°C)	4.2 (-15°C)	4.2 (-20°C)	3.7 (-15°C)	5.4 - 15	
	Back up heating capacity	kW	0.0 (-10°C)	0.0 (-10°C)	0.0 (-10°C)	0.0 (-10°C)	0.0 (-10°C)	0.0 - 10		
	Annual electricity consumption ^{(*)2}	kWh/a	1120	1134	1250	1275	1398	2132		
Operating Current (Max)	Input	Rated	kW	4.7	4.6	4.7	4.6	4.6	4.4	
		Operating Current(Max)	A	5.4	5.4	5.8	5.8	6.8	8.1	
	Dimensions	H*W*D	mm	1.3-6.0	1.3-6.0	1.4-7.3	1.4-7.3	2.0-8.6	2.2-10.3	
		Weight	kg	1.490	1.490	1.600	1.600	1.670	2.120	
	Indoor Unit	Air Volume (SLo-Lo-Mid-Hi-SH ^{(*)5} Dry/Wet)	Cooling	m ³ /min	5.4 - 6.5 - 7.7 - 9.3 - 11.4	5.4 - 6.5 - 7.7 - 9.3 - 11.4	6.0 - 7.2 - 8.4 - 10.0 - 12.6	6.0 - 7.2 - 8.4 - 10.0 - 12.6	9.4 - 11.3 - 13.2 - 16.0 - 18.9	9.5 - 11.4 - 13.2 - 15.3 - 18.6
			Heating	m ³ /min	5.3 - 6.1 - 7.7 - 9.4 - 14.0	5.3 - 6.1 - 7.7 - 9.4 - 14.0	5.6 - 6.5 - 8.2 - 10.0 - 14.0	5.6 - 6.5 - 8.2 - 10.0 - 14.0	9.4 - 11.3 - 13.2 - 16.0 - 18.1	9.5 - 11.4 - 13.2 - 15.3 - 18.7
Sound Level (SPL) (SLo-Lo-Mid-Hi-SH ^{(*)5})		Cooling	dB(A)	21 - 29 - 34 - 38 - 42	21 - 29 - 34 - 38 - 42	28 - 33 - 36 - 40 - 44	28 - 33 - 36 - 40 - 44	29 - 37 - 41 - 45 - 48	30 - 37 - 41 - 46 - 49	
		Heating	dB(A)	21 - 29 - 35 - 40 - 45	21 - 29 - 35 - 40 - 45	28 - 33 - 38 - 43 - 48	28 - 33 - 38 - 43 - 48	30 - 37 - 41 - 46 - 48	30 - 37 - 41 - 47 - 51	
Sound Level (PWL)		Cooling	dB(A)	57	57	58	58	65	65	
		Heating	dB(A)	57	57	58	58	65	65	
Outdoor Unit	Dimensions	H*W*D	mm	550-800-285	550-800-285	714-800-285	714-800-285	714-800-285	800-840-330	
		Weight	kg	35	35	40	40	40	55	
	Air Volume	Cooling	m ³ /min	30.4	30.4	40.5	40.5	52.1	54.1	
		Heating	m ³ /min	32.7	32.7	40.5	40.5	52.1	49.3	
	Sound Level (SPL)	Cooling	dB(A)	50	50	52	52	56	56	
		Heating	dB(A)	51	51	52	52	57	55	
Sound Level (PWL)	Cooling	dB(A)	61	61	64	64	69	69		
	Heating	dB(A)	61	61	64	64	69	69		
Ext. Piping	Operating Current (Max)	A	9.6	9.6	13.3	13.3	13.6	16		
		Breaker Size	A	10	10	16	16	16	20	
		Diameter	Liquid/Gas	mm	6.35 / 9.52	6.35 / 9.52	6.35 / 9.52	6.35 / 9.52	6.35 / 12.7	6.35 / 12.7
		Max.Length	Out-In	m	20	20	20	20	30	30
Guaranteed Operating Range (Outdoor)	Cooling	°C	-10 ~ +46	-10 ~ +46	-10 ~ +46	-10 ~ +46	-10 ~ +46	-10 ~ +46		
		Heating	°C	-15 ~ +24	-20 ~ +24	-15 ~ +24	-20 ~ +24	-15 ~ +24	-15 ~ +24	

(*1) Refrigerant leakage contributes to climate change. Refrigerant with lower global warming potential (GWP) would contribute less to global warming than a refrigerant with higher GWP, if leaked to the atmosphere. This appliance contains a refrigerant fluid with a GWP equal to 550. This means that if 1 kg of this refrigerant fluid would be leaked to the atmosphere, the impact on global warming would be 550 times higher than 1 kg of CO₂ over a period of 100 years. Never try to interfere with the refrigerant circuit yourself or disassemble the product yourself and always ask a professional.
The GWP of R32 is 675 in the IPCC 4th Assessment Report.

(*2) Energy consumption based on standard test results. Actual energy consumption will depend on how the appliance is used and where it is located.

(*3) SH: Super High

(*4) SEER, SCOP and other related description are based on COMMISSION DELEGATED REGULATION (EU) No.626/2011. The temperature conditions for calculating SCOP are based on "Average Season".

(*5) Please see page 00 for heating (warmer season) specifications.

MSZ-E SERIES

Developed to complement modern interior room décor, Kirigamine ZEN air conditioners are available in three colours specially chosen to blend in naturally wherever installed.

MSZ-EF18-50VGB



GOOD DESIGN



reddot award 2015 winner



Stylish Line-up Matches Any Room Décor

The streamlined wall-mounted indoor units have eloquent silver-bevelled edges, expressing sophistication and quality. Combining impressively low power consumption and quiet yet powerful performance, these units provide a best-match scenario for diverse interior designs while simultaneously ensuring maximum room and energy savings.



Energy-efficient Operation



All models in the series have achieved high energy-savings rating, and are contributing to reduced energy consumption in homes, offices and a range of other settings. Offered in a variety of output capacities and installation patterns, the vast applicability promises an ideal match for any user.

Indoor \ Outdoor	Rank A for single connection MUZ-EF25/35VG(H) MUZ-EF42/50VG	Compatibility					
		MXZ					
		2F33VF	2F42VF	2F53VF	3F54VF	3F68VF	4F72VF
MSZ-EF18VG	-	✓	✓	✓	✓	✓	✓
MSZ-EF22VG	-	✓	✓	✓	✓	✓	✓
MSZ-EF25VG	A+++ / A++ (A+++)	✓	✓	✓	✓	✓	✓
MSZ-EF35VG	A+++ / A++ (A++)		✓	✓	✓	✓	✓
MSZ-EF42VG	A++ / A+			✓	✓	✓	✓
MSZ-EF50VG	A++ / A+			✓	✓	✓	✓

*VEH

Quiet Comfort All Day Long

Mitsubishi Electric's advanced "Silent Mode" fan speed setting provides super-quiet operation as low as 19dB for EF18/22/25 models for cooling. This unique feature makes the Kirigamine ZEN series ideal for use in any situation.

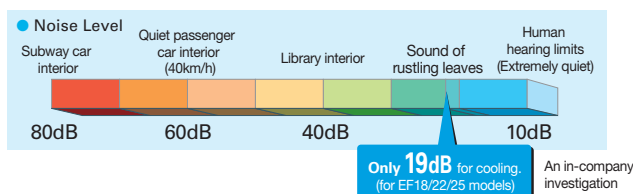

Superior Exterior and Operating Design Concept

The indoor unit of the Kirigamine ZEN keeps its amazingly thin form even during operation. The only physical change notable is the movement of the variable vent. As a result, a slim attractive look is maintained.

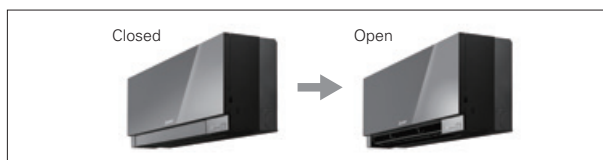

Low Standby Power

Electrical devices consume standby power even when they are not in actual use. While we obviously strive to reduce power consumption during actual use, reducing this wasted power that cannot be seen is also very important.

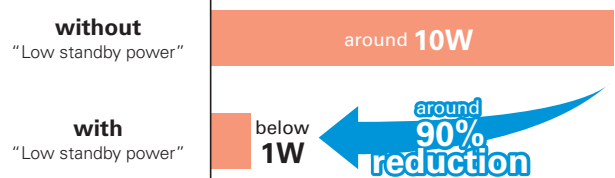

Outdoor Units for Cold Region (25/35)

Single split-type outdoor units are available in both standard and heater-equipped units. An electric heater is installed in each unit to prevent freezing in cold outdoor environments.

Standard Units



MUZ-EF25/35VG

Heater Installed



MUZ-EF25/35VGH

MSZ-E SERIES



Indoor Unit / Remote Controller

R32 R410A

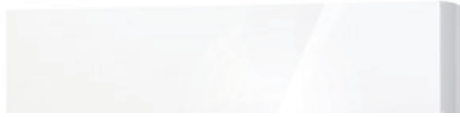

White

MSZ-EF18/22/25/35/42/50VGW



Silver

MSZ-EF18/22/25/35/42/50VGS



Black

MSZ-EF18/22/25/35/42/50VGB*

* Soft-dry Cloth is enclosed with Black models.



reddot award 2015 winner

Outdoor Unit

R32



MUZ-EF25/35VG(H), 42VG



MUZ-EF50VG



Type			Inverter Heat Pump								
Indoor Unit			MSZ-EF18VG	MSZ-EF22VG	MSZ-EF25VG	MSZ-EF25VGH	MSZ-EF35VG	MSZ-EF42VG	MSZ-EF50VG		
Outdoor Unit			for MXZ connection		MUZ-EF25VG	MUZ-EF25VGH	MUZ-EF35VG	MUZ-EF35VGH	MUZ-EF42VG	MUZ-EF50VG	
Refrigerant			R32 ⁽¹⁾								
Power Source			Outdoor Power supply								
Supply	Outdoor (V / Phase / Hz)		230/Single/50								
Cooling	Design load	kW	-	-	2.5	2.5	3.5	3.5	4.2	5.0	
	Annual electricity consumption ⁽²⁾	kWh/a	-	-	96	96	139	139	186	233	
	SEER ⁽⁴⁾		-	-	9.1	9.1	8.8	8.8	7.9	7.5	
	Capacity	Energy efficiency class		-	-	A+++	A+++	A+++	A+++	A++	A++
		Rated	kW	-	-	2.5	2.5	3.5	3.5	4.2	5.0
Heating	Design load	kW	-	-	2.4 (-10°C)	2.4 (-10°C)	2.9 (-10°C)	2.9 (-10°C)	3.8 (-10°C)	4.2 (-10°C)	
	Declared Capacity	at reference design temperature	kW	-	-	2.4 (-10°C)	2.4 (-10°C)	2.9 (-10°C)	2.9 (-10°C)	3.8 (-10°C)	4.2 (-10°C)
		at bivalent temperature	kW	-	-	2.4 (-10°C)	2.4 (-10°C)	2.9 (-10°C)	2.9 (-10°C)	3.8 (-10°C)	4.2 (-10°C)
	at operation limit temperature	kW	-	-	2.0 (-15°C)	1.6 (-20°C)	2.4 (-15°C)	1.7 (-20°C)	3.4 (-15°C)	3.5 (-15°C)	
	Back up heating capacity	kW	-	-	0.0 (-10°C)	0.0 (-10°C)	0.0 (-10°C)	0.0 (-10°C)	0.0 (-10°C)	0.0 (-10°C)	
Average Season ⁽³⁾	Annual electricity consumption ⁽²⁾	kWh/a	-	-	713	727	882	900	1151	1304	
	SCOP ⁽⁴⁾		-	-	4.7	4.6	4.6	4.5	4.6	4.5	
	Capacity	Energy efficiency class		-	-	A++	A++	A++	A+	A++	A+
		Rated	kW	-	-	3.2	3.2	4.0	4.0	5.4	5.8
	Total Input	Rated	kW	-	-	1.0-4.2	1.0-4.2	1.3-5.1	1.3-5.1	1.3-6.3	1.4-7.5
Operating Current (Max)	Input	Rated	A	-	7.1	7.1	7.1	7.1	10.0	14	
	Operating Current (Max)	A	0.026	0.026	0.026	0.026	0.030	0.030	0.033	0.043	
	Dimensions	H*W*D	mm	299-885-195	299-885-195	299-885-195	299-885-195	299-885-195	299-885-195	299-885-195	
	Weight	kg	-	-	11.5	11.5	11.5	11.5	11.5	11.5	
	Indoor Unit	Air Volume (SLo-Lo-Mid-Hi-SH ⁽⁵⁾ (Dry/Wet))	Cooling	m ³ /min	4.0-4.6-6.3-8.3-10.5	4.0-4.6-6.3-8.3-10.5	4.0-4.6-6.3-8.3-10.5	4.0-4.6-6.3-8.3-10.5	4.0-4.6-6.3-8.3-10.5	5.8-6.6-7.7-8.9-11.2	5.8-6.8-7.9-9.2-11.3
Heating			m ³ /min	4.0-4.6-6.2-8.9-11.9	4.0-4.6-6.2-8.9-11.9	4.0-4.6-6.2-8.9-11.9	4.0-4.6-6.2-8.9-11.9	4.0-4.6-6.2-8.9-12.7	5.5-6.3-7.8-9.9-13.2	6.4-7.2-9.0-11.1-14.6	
Sound Level (SPL) (SLo-Lo-Mid-Hi-SH ⁽⁵⁾)		Cooling	dB(A)	19-23-29-36-42	19-23-29-36-42	19-23-29-36-42	19-23-29-36-42	21-24-30-36-42	21-24-30-36-42	28-31-35-39-43	30-33-36-40-43
		Heating	dB(A)	21-24-29-37-45	21-24-29-37-45	21-24-29-37-45	21-24-29-37-45	21-24-30-38-46	21-24-30-38-46	28-30-35-41-48	30-33-37-43-49
Sound Level (PWL)		Cooling	dB(A)	60	60	60	60	60	60	60	60
Outdoor Unit	Dimensions	H*W*D	mm	-	-	550-800-285	550-800-285	550-800-285	550-800-285	550-800-285	714-900-285
	Weight	kg	-	-	31	31	34	34	35	40	
		Operating Current (Max)	A	-	-	6.8	6.8	6.8	6.8	9.6	13.6
	Air Volume	Cooling	m ³ /min	-	-	27.8	27.8	34.3	34.3	32.0	40.2
		Heating	m ³ /min	-	-	29.8	29.8	32.7	32.7	32.7	40.2
Sound Level (SPL)	Cooling	dB(A)	-	-	47	47	49	49	50	52	
	Heating	dB(A)	-	-	48	48	50	50	51	52	
Sound Level (PWL)	Cooling	dB(A)	-	-	58	58	62	62	62	65	
	Heating	dB(A)	-	-	58	58	62	62	62	65	
Ext. Piping	Operating Current (Max)	A	-	-	6.8	6.8	6.8	6.8	9.6	13.6	
	Breaker Size	A	-	-	10	10	10	10	12	16	
	Diameter	Liquid/Gas	mm	-	-	6.35 / 9.52	6.35 / 9.52	6.35 / 9.52	6.35 / 9.52	6.35 / 9.52	6.35 / 9.52
		Max.Length	Out-In	m	-	-	20	20	20	20	30
	Max.Height	Out-In	m	-	-	12	12	12	12	15	
Guaranteed Operating Range (Outdoor)	Cooling	°C	-	-	-10 ~ +46	-10 ~ +46	-10 ~ +46	-10 ~ +46	-10 ~ +46	-10 ~ +46	
	Heating	°C	-	-	-15 ~ +24	-20 ~ +24	-15 ~ +24	-20 ~ +24	-15 ~ +24	-15 ~ +24	

(1) Refrigerant leakage contributes to climate change. Refrigerant with lower global warming potential (GWP) would contribute less to global warming than a refrigerant with higher GWP, if leaked to the atmosphere. This appliance contains a refrigerant fluid with a GWP equal to 550. This means that if 1 kg of this refrigerant fluid would be leaked to the atmosphere, the impact on global warming would be 550 times higher than 1 kg of CO₂ over a period of 100 years. Never try to interfere with the refrigerant circuit yourself or disassemble the product yourself and always ask a professional.

The GWP of R32 is 675 in the IPCC 4th Assessment Report.

(2) Energy consumption based on standard test results. Actual energy consumption will depend on how the appliance is used and where it is located.

(3) SHi: Super High

(4) SEER, SCOP and other related descriptors are based on COMMISSION DELEGATED REGULATION (EU) No.626/2011. The temperature conditions for calculating SCOP are based on "Average Season".

(5) Please see page 00 for heating (warmer season) specifications.

MSZ-S SERIES

MSZ-G SERIES

Introducing a compact and stylish indoor unit with amazingly quiet performance. Not only are neat installations in small bedrooms possible, increase energy-savings by selecting the optimal capacity required for each room.



“Rank A++/A+” Energy Savings Achieved for Entire Range of Series



All models in the series, from the low-capacity 25 to the high-capacity 71, have achieved the “Rank A++” for SEER and “Rank A+” for SCOP as energy-savings rating. For home use, such as in bedrooms and living rooms, to light commercial use, such as in offices, our air conditioners are contributing to reduced energy consumption in a wide range.

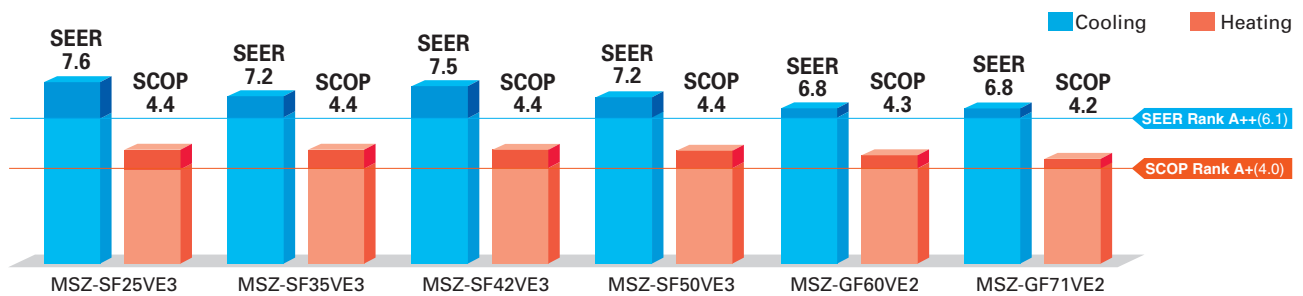

Wide Line-up

Eight different indoor units (Model 15-71) are available to meet your diversified air conditioning needs.



Compact and Stylish

(MSZ-SF15/20VA)

The stylish, square indoor unit adds a touch of class to any room interior. The compact design is 64mm thinner than our previous indoor unit with the lowest output capacity (MSZ-GE22VA).

Comparison with our previous model GE



Family Design

(MSZ-SF15/20/25/35/42/50)

Models in the 25-50 class are introduced as single-split units while retaining the popular design of the SF15/20VA* as indoor units exclusively for multi-systems. From small rooms to living rooms, it is possible to coordinate residences with a unified design.

*Size may vary.



“Weekly Timer”



Easily set desired temperatures and operation start/stop times to match lifestyle patterns. Reduce wasted energy consumption by using the timer to prevent forgetting to turn off the unit and eliminate temperature setting adjustments.

Example Operation Pattern (Winter/Heating mode)

	Mon.	Tues.	Wed.	Thurs.	Fri.	Sat.	Sun.
6:00	ON 20°C	ON 20°C	ON 20°C	ON 20°C	ON 20°C	ON 20°C	ON 20°C
8:00	Automatically changes to high-power operation at wake-up time						
10:00	OFF	OFF	OFF	OFF	OFF	ON 18°C	ON 18°C
12:00	Automatically turned off during work hours					Midday is warmer, so the temperature is set lower	
14:00							
16:00							
18:00	ON 20°C	ON 20°C	ON 20°C	ON 20°C	ON 20°C	ON 20°C	ON 20°C
20:00	Automatically turns on, synchronized with arrival at home					Automatically raises temperature setting to match time when outside-air temperature is low	
22:00 (during sleeping hours)	ON 18°C	ON 18°C	ON 18°C	ON 18°C	ON 18°C	ON 18°C	ON 18°C
	Automatically lowers temperature at bedtime for energy-saving operation at night						

Settings **Pattern Settings:** Input up to four settings for each day
Settings: •Start/Stop operation •Temperature setting *The operation mode cannot be set.

Easy set-up using dedicated buttons



The remote controller is equipped with buttons that are used exclusively for setting the Weekly Timer. Setting operation patterns is easy and quick.

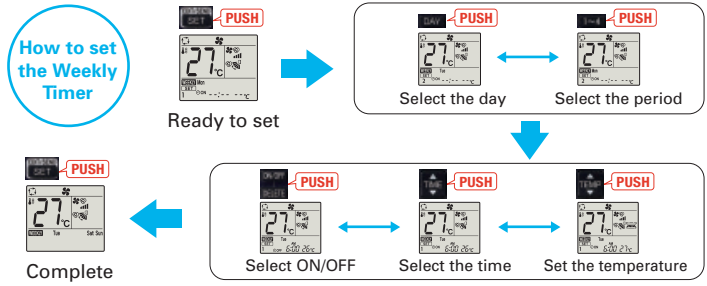

- Start by pushing the “SET” button and follow the instructions to set the desired patterns. Once all of the desired patterns are input, point the top end of the remote controller at the indoor unit and push the “SET” button one more time. (Push the “SET” button only after inputting all of the desired patterns into the remote controller memory. Pushing the “CANCEL” button will end the set-up process without sending the operation patterns to the indoor unit).
- It takes a few seconds to transmit the Weekly Timer operation patterns to the indoor unit. Please continue to point the remote controller at the indoor unit until all data has been sent.
- When “Weekly Timer” is set, temperature can not be set 10°C.

Low Standby Power

Electrical devices consume standby power even when they are not in actual use. While we obviously strive to reduce power consumption during actual use, reducing this wasted power that cannot be seen is also very important.

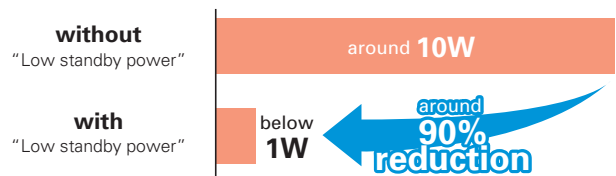

Air Purifying Filter (MSZ-SF25/35/42/50, MSZ-GF60/71)

This filter generates stable antibacterial and deodorising effects. The size of the three-dimensional surface has been increased as well, enlarging the filter capture area. These features give the Air Purifying Filter better dust collection performance than conventional filters. The superior air-cleaning effectiveness raises room comfort yet another level.

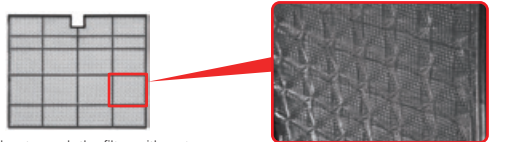

* It is okay to wash the filter with water (air-cleaning effect is maintained)

3D surface (Waved surface)

“i save” Mode



“i save” is a simplified setting function that recalls the preferred (preset) temperature by pressing a single button on the remote controller. Press the same button twice in repetition to immediately return to the previous temperature setting. Using this function contributes to comfortable, waste-free operation, realising the most suitable air conditioning settings and saving on power consumption when, for example, leaving the room or going to bed.

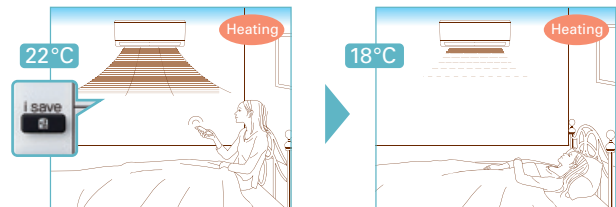

* Temperature can be preset to 10°C when heating in the “i-save” mode.

Outdoor Units for Cold Region (25/35/42/50)

Single split-type outdoor units are available in both standard and heater-equipped units. An electric heater is installed in each unit to prevent freezing in cold outdoor environments.



MSZ-S SERIES



Indoor Unit

R410A



MSZ-SF15/20VA

Outdoor Unit

For MXZ Connection Only

Remote Controller



Type		Inverter Heat Pump						
Indoor Unit		MSZ-SF15VA	MSZ-SF20VA	MSZ-SF25VE3	MSZ-SF25VE3	MSZ-SF35VE3	MSZ-SF35VE3	
Outdoor Unit		for MXZ connection		MUZ-SF25VE	MUZ-SF25VEH	MUZ-SF35VE	MUZ-SF35VEH	
Refrigerant		R410A ⁽¹⁾						
Power Source		Outdoor Power supply						
Supply		230/Single/50						
Cooling	Design load	kW		2.5	2.5	3.5	3.5	
	Annual electricity consumption ⁽²⁾	kWh/a		116	116	171	171	
	SEER ⁽³⁾			7.6	7.6	7.2	7.2	
	Capacity	Energy efficiency class		A++	A++	A++	A++	
		Rated	kW		2.5	2.5	3.5	3.5
Heating (Average Season) ⁽⁴⁾	Declared Capacity	at reference design temperature	kW		2.4(-10°C)	2.4(-10°C)	2.9(-10°C)	2.9(-10°C)
		at bivalent temperature	kW		2.4(-10°C)	2.4(-10°C)	2.9(-10°C)	2.9(-10°C)
	at operation limit temperature	kW		2.0(-15°C)	2.4(-10°C)	2.9(-10°C)	2.9(-10°C)	
	Back up heating capacity	kW		0.0(-10°C)	0.0(-10°C)	0.0(-10°C)	0.0(-10°C)	
	Annual electricity consumption ⁽²⁾	kWh/a		764	790	923	948	
Operating Current (Max)	Energy efficiency class		A+	A+	A+	A+		
	Rated	kW		3.2	3.2	4.0	4.0	
	Min-Max	kW		1.0-4.1	1.0-4.1	1.3-4.6	1.3-4.6	
	Total Input	kW		0.780	0.780	1.030	1.030	
Indoor Unit	Input		Rated	kW		0.017	0.019	
	Operating Current(Max)		A		0.17	0.19		
	Dimensions		H*W*D		mm	250-760-168		
	Weight		kg		7.7	7.7		
	Air Volume (SLo-Mid-Hi-SH ⁽⁵⁾ Dry/Wet)	Cooling	m ³ /min		3.5 - 3.9 - 4.6 - 5.5 - 6.4	3.5 - 3.9 - 4.6 - 5.5 - 6.9	3.2 - 4.1 - 5.6 - 7.2 - 9.1	3.2 - 4.1 - 5.6 - 7.2 - 9.1
m ³ /min			3.7 - 4.4 - 5.0 - 6.0 - 6.8	3.7 - 4.4 - 5.0 - 6.0 - 7.3	3.0 - 4.1 - 6.7 - 8.2 - 10.3	3.0 - 4.1 - 6.7 - 8.2 - 10.3		
Sound Level (SPL)		dB(A)		21 - 26 - 30 - 35 - 40	21 - 26 - 30 - 35 - 42	19 ⁽⁶⁾ - 24 - 30 - 36 - 42	19 ⁽⁶⁾ - 24 - 30 - 36 - 42	
		dB(A)		21 - 26 - 30 - 35 - 40	21 - 26 - 30 - 35 - 42	19 ⁽⁶⁾ - 24 - 34 - 39 - 45	19 ⁽⁶⁾ - 24 - 34 - 39 - 45	
Outdoor Unit	Sound Level (PWL)	dB(A)		59	60	57	57	
		dB(A)		-	-	57	57	
	Dimensions		H*W*D		mm	550-800-285		
	Weight		kg		31	31		
	Air Volume	Cooling	m ³ /min		-	-	31.1	31.1
m ³ /min			-	-	30.7	30.7		
Sound Level (SPL)		dB(A)		-	-	47	49	
		dB(A)		-	-	48	50	
Ext. Piping	Operating Current (Max)	A		58	58	62	62	
		A		8.2	8.2	8.2	8.2	
	Breaker Size		A		10	10		
	Diameter	Liquid/Gas		mm		6.35/9.52	6.35/9.52	
Max.Length		m		20	20			
Max.Height		m		12	12			
Guaranteed Operating Range (Outdoor)	Cooling	°C		-10 ~ +46	-10 ~ +46	-10 ~ +46	-10 ~ +46	
	Heating	°C		-15 ~ +24	-15 ~ +24	-15 ~ +24	-20 ~ +24	

(1) Refrigerant leakage contributes to climate change. Refrigerant with lower global warming potential (GWP) would contribute less to global warming than a refrigerant with higher GWP, if leaked to the atmosphere. This appliance contains a refrigerant fluid with a GWP equal to 1975. This means that if 1 kg of this refrigerant fluid would be leaked to the atmosphere, the impact on global warming would be 1975 times higher than 1 kg of CO₂, over a period of 100 years. Never try to interfere with the refrigerant circuit yourself or disassemble the product yourself and always ask a professional.
The GWP of R410A is 2088 in the IPCC 4th Assessment Report.

(2) Energy consumption based on standard test results. Actual energy consumption will depend on how the appliance is used and where it is located.

(3) SH: Super High

(4) SEER, SCOP and other related description are based on COMMISSION DELEGATED REGULATION (EU) No.626/2011. The temperature conditions for calculating SCOP are based on "Average Season".

(5) Please see page 00 for heating (warmer season) specifications.

(6) For single use: only 19dB(A). For multi use (MXZ): 21dB(A).

MSZ-S SERIES
MSZ-G SERIES



Indoor Unit

R410A



MSZ-SF25/35/42/50VE3



MSZ-GF60/71VE2

Outdoor Unit

R410A



MUZ-SF25/35/42VE(H)



MUZ-SF50VE(H)
MUZ-GF60/71VE

Remote Controller



Type	Inverter Heat Pump									
Indoor Unit	MSZ-SF42VE3	MSZ-SF42VE3	MSZ-SF50VE3	MSZ-SF50VE3	MSZ-GF60VE2	MSZ-GF71VE2				
Outdoor Unit	MUZ-SF42VE	MUZ-SF42VEH	MUZ-SF50VE	MUZ-SF50VEH	MUZ-GF60VE	MUZ-GF71VE				
Refrigerant	R410A ⁽¹⁾									
Power Source	Outdoor Power supply									
Supply	230/Single/50									
Cooling	Design load	kW	4.2	4.2	5.0	5.0	6.1	7.1		
	Annual electricity consumption ⁽²⁾	kWh/a	196	196	246	246	311	364		
	SEER ⁽⁴⁾		7.5	7.5	7.2	7.2	6.8	6.8		
	Energy efficiency class	Rated		A++	A++	A++	A++	A++	A++	
		Capacity	kW	4.2	4.2	5.0	5.0	6.1	7.1	
Heating (Average Season) ⁽⁵⁾	Design load	kW	3.8 (-10°C)	3.8 (-10°C)	4.2 (-10°C)	4.2 (-10°C)	4.6 (-10°C)	6.7 (-10°C)		
	Declared Capacity	at reference design temperature	kW	3.8 (-10°C)	3.8 (-10°C)	4.2 (-10°C)	4.2 (-10°C)	4.6 (-10°C)	6.7 (-10°C)	
		at bivalent temperature	kW	3.8 (-10°C)	3.8 (-10°C)	4.2 (-10°C)	4.2 (-10°C)	4.6 (-10°C)	6.7 (-10°C)	
		at operation limit temperature	kW	3.4 (-15°C)	3.2 (-20°C)	3.4 (-15°C)	2.3 (-20°C)	3.7 (-15°C)	5.4 (-15°C)	
	Back up heating capacity	kW	0.0 (-10°C)	0.0 (-10°C)	0.0 (-10°C)	0.0 (-10°C)	0.0 (-10°C)	0.0 (-10°C)		
SCOP ⁽⁴⁾	Annual electricity consumption ⁽²⁾	kWh/a	1215	1242	1351	1380	1489	2204		
	Rated		4.4	4.3	4.4	4.3	4.3	4.2		
	Energy efficiency class	Rated		A+	A+	A+	A+	A+		
		Capacity	kW	5.4	5.4	5.8	5.8	6.8	8.1	
	Total Input	kW	1.3-6.0	1.3-6.0	1.4-7.3	1.4-7.3	2.0-9.3	2.2-9.9		
Indoor Unit	Operating Current (Max)	A	1.580	1.580	1.700	1.700	1.810	2.230		
	Input	Rated	kW	9.5	9.5	12.3	12.3	14.5	16.6	
		Operating Current(Max)	A	0.027	0.027	0.035	0.035	0.062	0.058	
	Dimensions	H*W*D	mm	299-798-195	299-798-195	299-798-195	299-798-195	325-1100-238	325-1100-238	
	Weight	kg		10	10	10	10	16	16	
Outdoor Unit	Air Volume (SLo-Lo-Mid-Hi-SH ⁽³⁾ Dry/Wet)	Cooling	m ³ /min	4.7 - 5.8 - 6.7 - 7.9 - 9.1	4.7 - 5.8 - 6.7 - 7.9 - 9.1	5.1 - 6.2 - 7.0 - 8.2 - 9.9	5.1 - 6.2 - 7.0 - 8.2 - 9.9	9.8-11.3-13.4-15.6-18.3	9.7-11.5-13.3-15.4-17.8	
	Sound Level (SPL)	Cooling	dB(A)	4.7 - 5.8 - 7.2 - 9.1 - 11.4	4.7 - 5.8 - 7.2 - 9.1 - 11.4	5.1 - 6.4 - 8.0 - 9.8 - 12.0	5.1 - 6.4 - 8.0 - 9.8 - 12.0	9.8-11.3-13.4-15.6-18.3	10.2-11.5-13.3-15.4-17.8	
		Heating	dB(A)	26 ⁽⁶⁾ - 31 - 34 - 38 - 42	26 ⁽⁶⁾ - 31 - 34 - 38 - 42	28 ⁽⁷⁾ - 33 - 36 - 40 - 45	28 ⁽⁷⁾ - 33 - 36 - 40 - 45	29 - 37 - 41 - 45 - 49	30 - 37 - 41 - 45 - 49	
	Sound Level (PWL)	Cooling	dB(A)	26 ⁽⁶⁾ - 31 - 36 - 42 - 47	26 ⁽⁶⁾ - 31 - 36 - 42 - 47	28 ⁽⁷⁾ - 33 - 38 - 43 - 49	28 ⁽⁷⁾ - 33 - 38 - 43 - 49	29 - 37 - 41 - 45 - 49	30 - 37 - 41 - 45 - 49	
		Heating	dB(A)	57	57	58	58	65	65	
Ext. Piping	Dimensions	H*W*D	mm	550-800-285	550-800-285	880-840-330	880-840-330	880-840-330	880-840-330	
	Weight	kg		35	35	55	55	50	53	
	Air Volume	Cooling	m ³ /min		35.2	35.2	44.6	44.6	49.2	50.1
		Heating	m ³ /min		33.6	33.6	44.6	44.6	49.2	48.2
	Operating Current (Max)	A		50	50	52	52	55	55	
Breaker Size	A		51	51	52	52	55	55		
Guaranteed Operating Range (Outdoor)	Diameter	Liquid/Gas	mm	6.35 / 9.52	6.35 / 9.52	6.35 / 12.7	6.35 / 12.7	6.35/15.88	9.52/15.88	
		Max.Length	Out-In	m	20	20	30	30	30	30
	Max.Height	Out-In	m	12	12	15	15	15	15	
		Guaranteed Operating Range	Cooling	°C	-10 ~ +46	-10 ~ +46	-10 ~ +46	-10 ~ +46	-10 ~ +46	-10 ~ +46
	Heating	°C	-15 ~ +24	-20 ~ +24	-15 ~ +24	-20 ~ +24	-15 ~ +24	-15 ~ +24		

(1) Refrigerant leakage contributes to climate change. Refrigerant with lower global warming potential (GWP) would contribute less to global warming than a refrigerant with higher GWP, if leaked to the atmosphere. This appliance contains a refrigerant fluid with a GWP equal to 1975. This means that if 1 kg of this refrigerant fluid would be leaked to the atmosphere, the impact on global warming would be 1975 times higher than 1 kg of CO₂, over a period of 100 years. Never try to interfere with the refrigerant circuit yourself or disassemble the product yourself and always ask a professional.
The GWP of R410A is 2088 in the IPCC 4th Assessment Report.

(2) Energy consumption based on standard test results. Actual energy consumption will depend on how the appliance is used and where it is located.

(3) SH: Super High

(4) SEER, SCOP and other related description are based on COMMISSION DELEGATED REGULATION (EU) No.626/2011. The temperature conditions for calculating SCOP are based on "Average Season".

(5) Please see page 00 for heating (warmer season) specifications.

(6) For single use: only 26dB(A). For multi use (MXZ): 28dB(A).

(7) For single use: only 28dB(A). For multi use (MXZ): 30dB(A).

MSY-TP SERIES

Cooling only model with high-performance provide high SHF in various environments thanks to wide operation range.

R32

MSY-TP35/50VF



High Energy-Saving Performance with High SHF

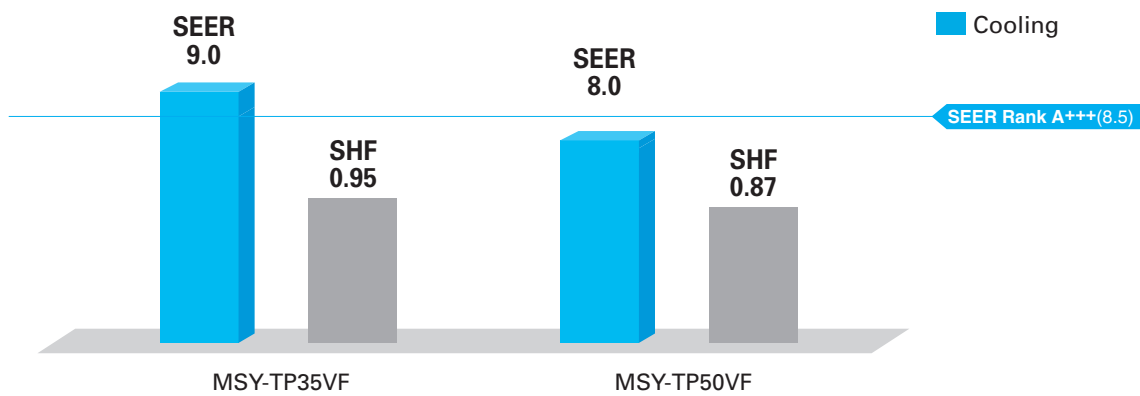

Wide Cooling Operating Range

As a result of an extended operating range in cooling, these models accommodate a wide range of usage environments and applications.

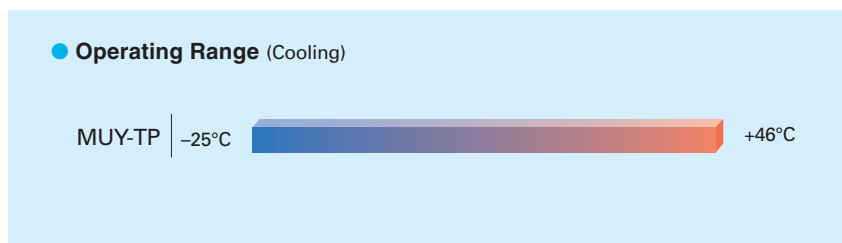

MSY-TP SERIES



Indoor Unit



MSY-TP35/50VF

Outdoor Unit



MUY-TP35/TP50VF

Remote Controller

- Wired remote controller can be connected to indoor unit.

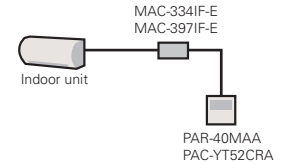

Type		Inverter Heat Pump				
Indoor Unit		MSY-TP35VF		MSY-TP50VF		
Outdoor Unit		MUY-TP35VF		MUY-TP50VF		
Refrigerant		R32				
Power Supply Source		Indoor Power supply				
Outdoor (V / Phase / Hz)		230V / Single / 50Hz				
Cooling	Design load	kW	3.5	5.0		
	Annual electricity consumption ⁽²⁾	kWh/a	136	218		
	SEER ⁽⁴⁾		9.0	8.0		
	Capacity	Energy efficiency class		A+++	A++	
		Rated	kW	3.5	5.0	
	Total Input	Min-Max	kW	1.5 - 4.0	1.5 - 5.7	
Rated		kW	0.760	1.450		
Heating (Average Season) ⁽³⁾	Design load	kW	-	-		
	Declared Capacity	at reference design temperature	kW	-	-	
		at bivalent temperature	kW	-	-	
		at operation limit temperature	kW	-	-	
	Back up heating capacity	kW	-	-		
	Annual electricity consumption ⁽²⁾	kWh/a	-	-		
	SCOP ⁽⁴⁾		-	-		
	Capacity	Energy efficiency class		-	-	
Rated		kW	-	-		
Total Input	Min-Max	kW	-	-		
	Rated	kW	-	-		
Operating Current (Max)		A	9.6	9.6		
Indoor Unit	Input	Rated	kW	0.033	0.034	
		Operating Current (Max)	A	0.4	0.4	
	Dimensions		H*W*D	mm	305-923-250	305-923-250
	Weight		kg	12.5	12.5	
	Air Volume (Lo-Mid-Hi-SHi ⁽³⁾ /Dry/Wet)	Cooling	m ³ /min	10.1 - 11.6 - 13.7 - 16.4	10.1 - 11.6 - 13.7 - 16.4	
		Heating	m ³ /min	-	-	
	Sound Level (SPL) (Lo-Mid-Hi-SHi ⁽³⁾)	Cooling	dB(A)	31 - 36 - 40 - 45	31 - 36 - 40 - 45	
		Heating	dB(A)	-	-	
	Sound Level (PWL)	Cooling	dB(A)	60	60	
		Heating	dB(A)	10	10	
	Breaker Size		A	10	10	
	Outdoor Unit	Dimensions		H*W*D	mm	550-800-285
Weight		kg	34	34		
Air Volume		Cooling	m ³ /min	29.3	29.3	
		Heating	m ³ /min	-	-	
Sound Level (SPL)		Cooling	dB(A)	45	47	
		Heating	dB(A)	-	-	
Sound Level (PWL)		Cooling	dB(A)	58	61	
		Heating	dB(A)	9.2	9.2	
Operating Current (Max)		A	9.2	9.2		
Ext. Piping	Diameter	Liquid/Gas	mm	6.35/9.52	6.35/9.52	
	Max.Length	Out-In	m	20	20	
	Max.Height	Out-In	m	12	12	
Guaranteed Operating Range (Outdoor)	Cooling	°C	-25 ~ +46	-25 ~ +46		
	Heating	°C	-	-		

(1) Refrigerant leakage contributes to climate change. Refrigerant with lower global warming potential (GWP) would contribute less to global warming than a refrigerant with higher GWP, if leaked to the atmosphere. This appliance contains a refrigerant fluid with a GWP equal to 550. This means that if 1 kg of this refrigerant fluid would be leaked to the atmosphere, the impact on global warming would be 550 times higher than 1 kg of CO₂ over a period of 100 years. Never try to interfere with the refrigerant circuit yourself or disassemble the product yourself and always ask a professional.

The GWP of R32 is 675 in the IPCC 4th Assessment Report.

(2) Energy consumption based on standard test results. Actual energy consumption will depend on how the appliance is used and where it is located.

(3) SHi: Super High

(4) SEER and other related description are based on COMMISSION DELEGATED REGULATION (EU) No.626/2011.

MSZ-H SERIES

Compact, high-performance indoor and outdoor units and advanced inverter technologies provide superior energy savings and comfort in all rooms.

R410A

MSZ-HJ25/35/50VA

MSZ-HJ60/71VA



Stylish Design with Flat Panel Front

A stylish flat panel design is employed for the front of the indoor unit. The simple look matches room aesthetics.

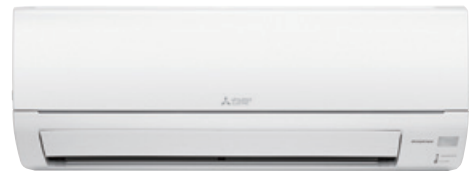

Advanced Inverter Control – Efficient Operation All the Time

DC Inverter



Mitsubishi Electric's cutting-edge inverter technologies are adopted to provide automatic adjustment of operation load according to need. This reduces excessive consumption of electricity, and thereby realises an Energy Rank "A" rating for 25/35 classes and "A+" for 50/60/71 classes.

Silent Operation

Quiet, relaxing space is within reach. Operational noise is a low 22dB (25/35 classes). Operation is so silent you might even forget the air conditioner is on.

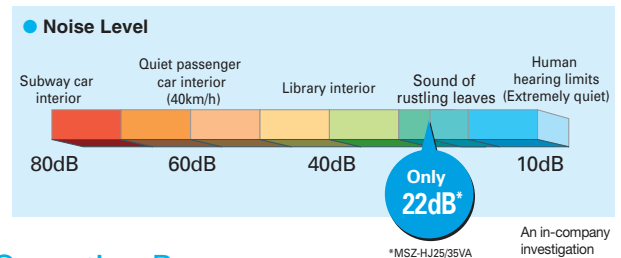

Long Piping Length

Compared to previous models, the piping length is significantly increased, further enhancing the ease and flexibility of installation.

	MSZ-HJ60/71	MSZ-HJ25/35/50	MSZ-HC
Max piping length	30m	20m	10m
Max piping height difference	15m	12m	5m

Operating Range

As a result of an extended operating range in cooling, these models accommodate a wider range of usage environments and applications than previous models.

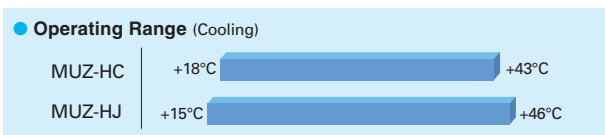

Compact Units

The widths of both indoor and outdoor units are compact, making installation in smaller, tighter spaces possible.

Indoor Unit: MSZ-HJ25/35/50VA



Only 799mm width

Outdoor Unit: MUZ-HJ25/35VA



Only 699mm width

Compared to other models, width is down by 16%.

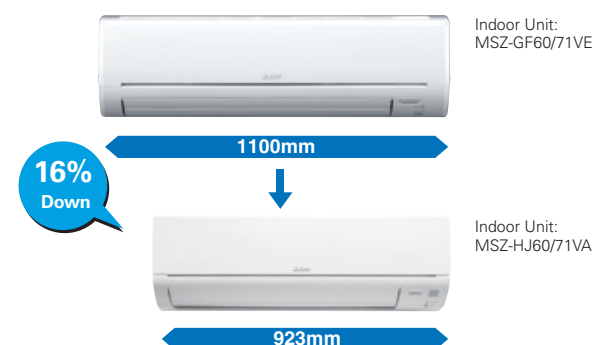

MSZ-H SERIES



Indoor Unit

R410A



MSZ-HJ25/35/50VA



MSZ-HJ60/71VA

Outdoor Unit

R410A



MUZ-HJ25/35VA



MUZ-HJ50VA



MUZ-HJ60/71VA

Remote Controller



Type	Inverter Heat Pump											
Indoor Unit	MSZ-HJ25VA		MSZ-HJ35VA		MSZ-HJ50VA		MSZ-HJ60VA		MSZ-HJ71VA			
Outdoor Unit	MUZ-HJ25VA		MUZ-HJ35VA		MUZ-HJ50VA		MUZ-HJ60VA		MUZ-HJ71VA			
Refrigerant	R410A ⁽¹⁾											
Power Source	Indoor Power supply											
Supply	Outdoor (V / Phase / Hz)											
Cooling	Design load	kW	2.5	3.1	5.0	6.1	7.1					
	Annual electricity consumption ⁽²⁾	kWh/a	171	212	292	354	441					
	SEER ⁽⁴⁾		5.1	5.1	6.0	6.0	5.6					
	Capacity	Energy efficiency class		A		A+		A+		A+		
		Rated	kW	2.5	3.15	5.0	6.1	7.1				
Heating (Average Season) ⁽³⁾	Design load	kW	1.9 (-10°C)	2.4 (-10°C)	3.8 (-10°C)	4.6 (-10°C)	5.4 (-10°C)					
	Declared Capacity	at reference design temperature	kW	1.9 (-10°C)	2.4 (-10°C)	3.8 (-10°C)	4.6 (-10°C)	5.4 (-10°C)				
		at bivalent temperature	kW	1.9 (-10°C)	2.4 (-10°C)	3.8 (-10°C)	4.6 (-10°C)	5.4 (-10°C)				
		at operation limit temperature	kW	1.9 (-10°C)	2.4 (-10°C)	3.8 (-10°C)	4.6 (-10°C)	5.4 (-10°C)				
	Back up heating capacity	kW	0.0 (-10°C)	0.0 (-10°C)	0.0 (-10°C)	0.0 (-10°C)	0.0 (-10°C)					
Annual electricity consumption ⁽²⁾	kWh/a	698	885	1267	1544	1854						
Operating Current (Max)	SCOP ⁽⁴⁾		3.8	3.8	4.2	4.1	4.0					
	Energy efficiency class		A		A+		A+		A+			
	Rated	kW	3.15	3.6	5.4	6.8	8.1					
	Min-Max	kW	0.9 - 3.5	1.1 - 4.1	1.4 - 6.5	1.5 - 8.4	1.5 - 8.5					
	Total Input	kW	0.870	0.995	1.480	1.970	2.440					
Indoor Unit	Operating Current (Max)		A		A		A		A			
	Input	kW	0.020	0.024	0.037	0.055	0.055					
	Operating Current(Max)	A	0.3	0.3	0.4	0.5	0.5					
	Dimensions	H*W*D	mm	290-799-232	290-799-232	290-799-232	305-923-250	305-923-250				
	Weight	kg	9	9	9	13	13					
	Air Volume (SLo-Lo-Mid-Hi-SHi ⁽⁵⁾ (Dry/Wet))	Cooling	m ³ /min	3.8 - 5.5 - 7.3 - 9.5	3.8 - 5.7 - 7.8 - 10.9	6.3 - 9.1 - 11.1 - 12.9	9.3 - 12.2 - 15.0 - 19.9	10.0 - 12.2 - 15.0 - 19.9				
		Heating	m ³ /min	3.5 - 5.5 - 7.5 - 10.0	3.5 - 5.5 - 7.5 - 10.3	6.1 - 8.3 - 11.1 - 14.3	9.4 - 12.5 - 16.0 - 19.9	10.3 - 12.7 - 16.4 - 19.9				
		Cooling	dB(A)	22 - 30 - 37 - 43	22 - 31 - 38 - 45	28 - 36 - 40 - 45	31 - 38 - 44 - 50	33 - 38 - 44 - 50				
		Heating	dB(A)	23 - 30 - 37 - 43	23 - 30 - 37 - 44	27 - 34 - 41 - 47	31 - 38 - 44 - 49	33 - 38 - 44 - 49				
	Sound Level (PWL)	Cooling	dB(A)	57	60	65	65	65				
Heating		dB(A)	57	60	65	65	65					
Outdoor Unit	Dimensions		H*W*D		mm		538-699-249		538-699-249			
	Weight		kg		24		25		36			
	Air Volume	Cooling	m ³ /min	31.5	31.5	36.3	47.9	49.3				
		Heating	m ³ /min	31.5	31.5	34.8	47.9	47.9				
	Sound Level (SPL)	Cooling	dB(A)	50	50	55	55	55				
		Heating	dB(A)	50	50	51	55	55				
	Sound Level (PWL)	Cooling	dB(A)	63	64	64	65	66				
		Heating	dB(A)	63	64	64	65	66				
	Operating Current (Max)		A		5.5		6.2		9.4		12.0	
	Breaker Size		A		10		10		12		16	
Ext. Piping	Diameter	Liquid/Gas	mm	6.35/9.52	6.35/9.52	6.35/12.7	6.35/15.88	9.52/15.88				
	Max.Length	Out-In	m	20	20	20	30	30				
	Max.Height	Out-In	m	12	12	12	15	15				
Guaranteed Operating Range (Outdoor)	Cooling	°C	+15 ~ +46	+15 ~ +46	+15 ~ +46	+15 ~ +46	+15 ~ +46					
	Heating	°C	-10 ~ +24	-10 ~ +24	-10 ~ +24	-10 ~ +24	-10 ~ +24					

⁽¹⁾ Refrigerant leakage contributes to climate change. Refrigerant with lower global warming potential (GWP) would contribute less to global warming than a refrigerant with higher GWP, if leaked to the atmosphere. This appliance contains a refrigerant fluid with a GWP equal to 1975. This means that if 1 kg of this refrigerant fluid would be leaked to the atmosphere, the impact on global warming would be 1975 times higher than 1 kg of CO₂ over a period of 100 years. Never try to interfere with the refrigerant circuit yourself or disassemble the product yourself and always ask a professional.

The GWP of R410A is 2088 in the IPCC 4th Assessment Report.

⁽²⁾ Energy consumption based on standard test results. Actual energy consumption will depend on how the appliance is used and where it is located.

⁽³⁾ SHi: Super High

⁽⁴⁾ SEER, SCOP and other related description are based on COMMISSION DELEGATED REGULATION (EU) No.626/2011. The temperature conditions for calculating SCOP are based on "Average Season".

⁽⁵⁾ Please see page 00 for heating (warmer season) specifications.

MSZ-HR SERIES

MSZ-HR25/35/42/50VF

R32



Compact, high-performance indoor and outdoor units with R32 that is low global warming potential compared with the current refrigerant R410A contribute to room comfort and to prevent global warming.

“Rank A++/A+” Energy Savings Achieved for Entire Range of Series



All models in the series, from capacity 25 to 50, have achieved the “Rank A++” for SEER and “Rank A+” for SCOP as energy-savings rating, thanks to Mitsubishi Electric’s inverter technologies which are adopted to provide automatic adjustment of operation load according to need.

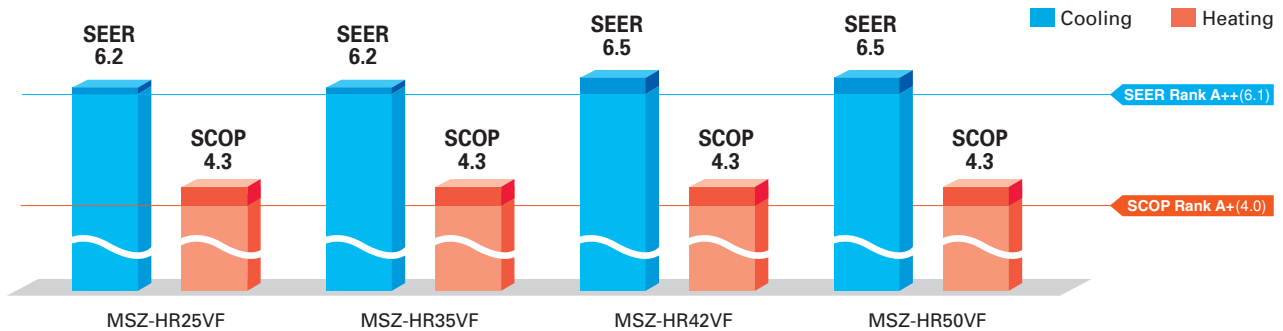

Simple and Friendly Design

The round front surface provides a simple and friendly impression. And the width of indoor unit is compact, making installation in smaller, tighter spaces possible.



Wi-Fi and System Control

Wi-Fi Interface (Optional)

Optional interface enabling users to control air conditioners and check operating status via devices such as personal computers, tablets and smartphones.

System Control Interface (Optional)

- Remote on/off operation is possible by input to the connector.
- Depending on the interface used, connecting a wired remote-control such as the PAR-40MAA is possible.
- Centralised control is possible when connected to M-NET.

*Wi-Fi Interface and System Control Interface cannot be used simultaneously.

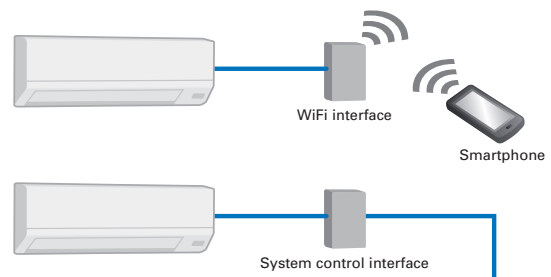

MSZ-HR SERIES



Indoor Unit



MSZ-HR25/35/42/50VF

Outdoor Unit



MUZ-HR25VF



MUZ-HR35VF



MUZ-HR42/50VF

Remote Controller

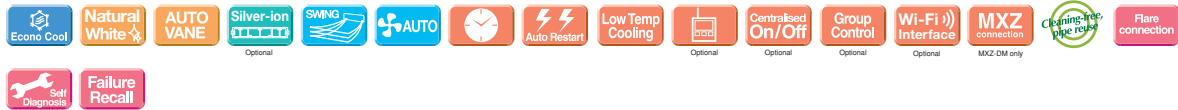

Type	Inverter Heat Pump						
Indoor Unit	MSZ-HR25VF	MSZ-HR35VF	MSZ-HR42VF	MSZ-HR50VF			
Outdoor Unit	MUZ-HR25VF	MUZ-HR35VF	MUZ-HR42VF	MUZ-HR50VF			
Refrigerant	R32 ⁽¹⁾						
Power Source	Indoor Power supply						
Supply	Outdoor (V / Phase / Hz)						
					230V/Single/50Hz		
Cooling	Design load	kW	2.5	3.4	4.2	5.0	
	Annual electricity consumption ⁽²⁾	kWh/a	141	191	226	269	
	SEER ⁽⁴⁾		6.2	6.2	6.5	6.5	
	Capacity	Energy efficiency class		A++	A++	A++	A++
		Rated	kW	2.5	3.4	4.2	5.0
	Min-Max	kW	0.5-2.9	0.9-3.4	1.1-4.6	1.3-5.0	
	Total Input	Rated	kW	0.800	1.210	1.340	2.050
Heating (Average Season) ⁽³⁾	Design load	kW	1.9 (-10°C)	2.4 (-10°C)	2.9 (-10°C)	3.8 (-10°C)	
	Declared Capacity	at reference design temperature	kW	1.9 (-10°C)	2.4 (-10°C)	2.9 (-10°C)	3.8 (-10°C)
		at bivalent temperature	kW	1.9 (-10°C)	2.4 (-10°C)	2.9 (-10°C)	3.8 (-10°C)
		at operation limit temperature	kW	1.9 (-10°C)	2.4 (-10°C)	2.9 (-10°C)	3.8 (-10°C)
	Back up heating capacity	kW	0.0 (-10°C)	0.0 (-10°C)	0.0 (-10°C)	0.0 (-10°C)	
	Annual electricity consumption ⁽²⁾	kWh/a	614	781	928	1224	
	SCOP ⁽⁴⁾		4.3	4.3	4.3	4.3	
	Capacity	Energy efficiency class		A+	A+	A+	A+
		Rated	kW	3.15	3.6	4.7	5.4
		Min-Max	kW	0.7-3.5	0.9-3.7	0.9-5.4	1.4-6.5
	Total Input	Rated	kW	0.850	0.975	1.300	1.550
Operating Current (Max)	Input	Rated	kW	0.020	0.028	0.032	0.039
	Operating Current(Max)	A	0.2	0.27	0.3	0.36	
Indoor Unit	Dimensions	H*W*D	mm	280-838-228	280-838-228	280-838-228	280-838-228
	Weight		kg	8.5	8.5	9	9
	Air Volume (Lo-Mid-Hi-SH) ⁽⁵⁾ (Dry/Wet)	Cooling	m ³ /min	3.6 - 5.4 - 7.2 - 9.7	3.6 - 5.6 - 7.8 - 11.7	6.0 - 8.7 - 10.8 - 13.1	6.4 - 9.2 - 11.2 - 13.1
		Heating	m ³ /min	3.3 - 5.4 - 7.4 - 10.1	3.3 - 5.4 - 7.4 - 10.5	5.6 - 7.9 - 10.8 - 13.4	6.1 - 8.3 - 11.2 - 14.5
	Sound Level (SPL) (Lo-Mid-Hi-SH) ⁽⁵⁾	Cooling	dB(A)	21 - 30 - 37 - 43	22 - 31 - 38 - 46	24 - 34 - 39 - 45	26 - 36 - 40 - 45
		Heating	dB(A)	21 - 30 - 37 - 43	21 - 30 - 37 - 44	24 - 32 - 40 - 46	27 - 34 - 41 - 47
	Sound Level (PWL)	Cooling	dB(A)	57	60	60	60
Dimensions	H*W*D	mm	538-699-249	538-699-249	550-800-285	550-800-285	
Outdoor Unit	Weight		kg	23	24	34	35
	Air Volume	Cooling	m ³ /min	30.3	32.2	30.4	30.4
		Heating	m ³ /min	30.3	32.2	32.7	32.7
	Sound Level (SPL)	Cooling	dB(A)	50	51	50	50
		Heating	dB(A)	50	51	51	51
	Sound Level (PWL)	Cooling	dB(A)	63	64	64	64
	Operating Current (Max)	A	4.8	6.4	8.2	9.6	
Breaker Size	A	10	10	10	12		
Ext. Piping	Diameter	Liquid/Gas	mm	6.35 / 9.52	6.35 / 9.52	6.35 / 9.52	6.35 / 9.52
	Max.Length	Out-In	m	20	20	20	20
	Max.Height	Out-In	m	12	12	12	12
Guaranteed Operating Range (Outdoor)	Cooling	°C	-10 ~ +46	-10 ~ +46	-10 ~ +46	-10 ~ +46	
	Heating	°C	-10 ~ +24	-10 ~ +24	-10 ~ +24	-10 ~ +24	

⁽¹⁾ Refrigerant leakage contributes to climate change. Refrigerant with lower global warming potential (GWP) would contribute less to global warming than a refrigerant with higher GWP, if leaked to the atmosphere. This appliance contains a refrigerant fluid with a GWP equal to 550. This means that if 1 kg of this refrigerant fluid would be leaked to the atmosphere, the impact on global warming would be 550 times higher than 1 kg of CO₂ over a period of 100 years. Never try to interfere with the refrigerant circuit yourself or disassemble the product yourself and always ask a professional.

The GWP of R32 is 675 in the IPCC 4th Assessment Report.

⁽²⁾ Energy consumption based on standard test results. Actual energy consumption will depend on how the appliance is used and where it is located.

⁽³⁾ SH: Super High

⁽⁴⁾ SEER, SCOP and other related description are based on COMMISSION DELEGATED REGULATION (EU) No.626/2011. The temperature conditions for calculating SCOP are based on "Average Season".

⁽⁵⁾ Please see page 00 for heating (warmer season) specifications.

MFZ-KT SERIES

R32

MFZ-KT25/35/50/60VG

High Capacity, Energy Savings and a Design in Harmony with Living Spaces
Raise the Value of Your Room to the Next Level.



Simple , Flat Design

Un de a simple design with linear beauty, harmonised with all types of interiors.

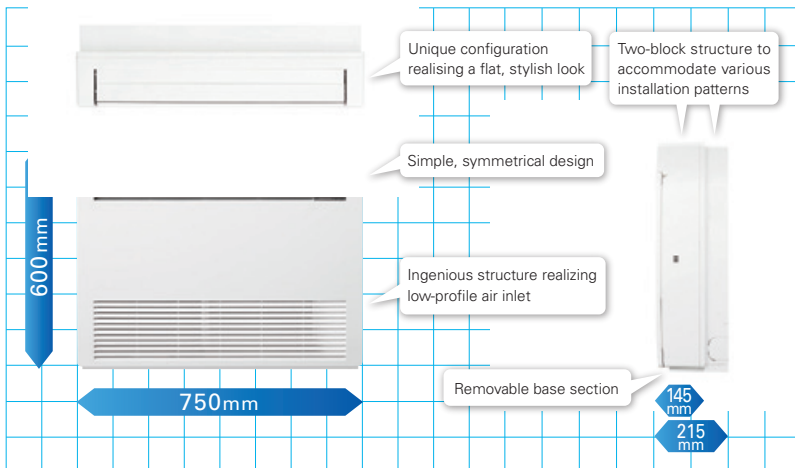

Images of installed unit

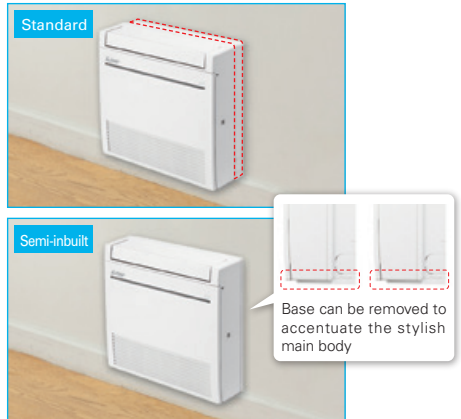

Multi-flow Vane

Three uniquely shaped vanes control the airflow and allow the freedom to customize comfort according to preferences.

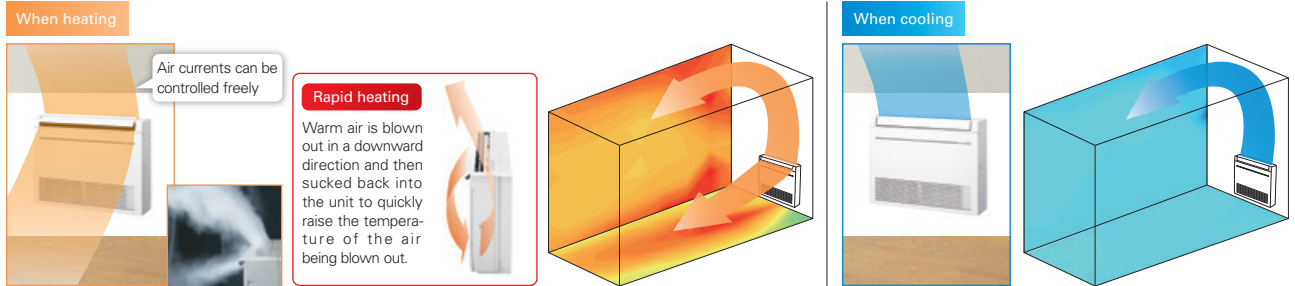

* The downward airflow is also possible as well as heating.

Excellent Energy-saving Performance



SEER A++ and SCOP A+ ratings have been achieved through development focusing on compliance with European energy-related product (ErP) regulations.

Weekly Timer (Introduced in response to market demand)

Temperature settings and On/Off control can be managed over a period of one week using the Weekly Timer. Up to eight setting patterns per calendar day are possible.

Quiet Operation

The indoor unit noise level is as low as 19dB for MFZ Series, offering a peaceful inside environment.

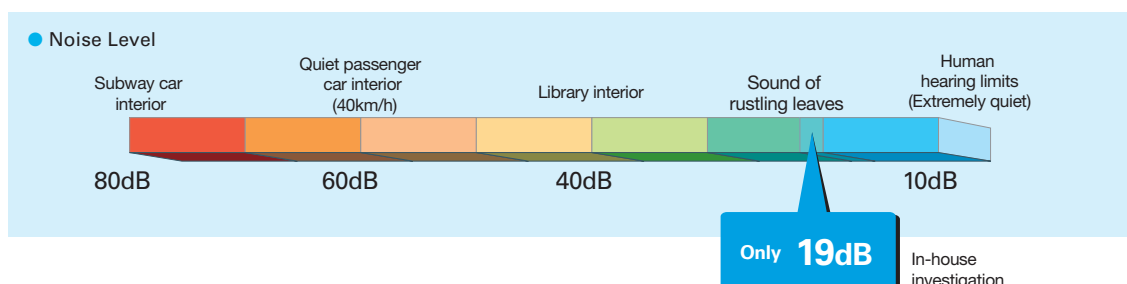

MFZ-KT SERIES



Indoor Unit

R32



MFZ-KT25/35/50/60VG



Outdoor Unit

R32



SUZ-M25/35VA



SUZ-M50VA



SUZ-M60/71VA

Remote Controller



Type	Inverter Heat Pump						
Indoor Unit	MFZ-KT25VG	MFZ-KT35VG	MFZ-KT50VG	MFZ-KT60VG			
Outdoor Unit	SUZ-M25VA	SUZ-M35VA	SUZ-M50VA	SUZ-M60VA			
Refrigerant	R32(*1)	R32(*1)	R32(*1)	R32(*1)			
Power Supply	Outdoor power supply 230 / Single / 50						
Cooling	Design load	kW	2.5	3.5	5.0	6.0	
	Annual electricity consumption ^{(*)2}	kWh/a	-	-	-	-	
	SEER ^{(*)4}		6.5	6.6	6.8	6.2	
	Capacity	Energy efficiency class		A++	A++	A++	A++
		Rated	kW	2.5	3.5	5.0	5.0
Heating (Average Season)	Total Input	Rated	kW	0.625	1.06	1.55	1.81
	Declared Capacity	Design load	kW	-	-	-	-
		at reference design temperature	kW	-	-	-	-
		at bivalent temperature	kW	-	-	-	-
	Back up heating capacity	at operation limit temperature	kW	-	-	-	-
Annual electricity consumption ^{(*)2}		kWh/a	-	-	-	-	
SCOP ^{(*)4}			4.2	4.4	4.2	4.1	
Operating Current (Max)	Energy efficiency class		A+	A+	A+	A+	
	Rated	kW	3.4	4.3	6.0	7.0	
	Min-Max	kW	-	-	-	-	
	Total Input	Rated	kW	0.99	1.26	2.00	2.18
	Operating Current (Max)	A	-	-	-	-	
Indoor Unit	Input	Rated	kW	-	-	-	
	Operating Current(Max)	A	-	-	-	-	
	Dimensions	H*W*D	mm	600-750-215	600-750-215	600-750-215	600-750-215
	Weight	kg	-	-	-	-	
	Air Volume (SLo-Lo-Mid-Hi-SH ^{(*)3} Dry/Wet)	Cooling	m ³ /min	-	-	-	-
		Heating	m ³ /min	-	-	-	-
	Sound Level (SPL) (SLo-Lo-Mid-Hi-SH ^{(*)3})	Cooling	dB(A)	20 - 25 - 310 - 37 - 41	20 - 25 - 30 - 35 - 39	28 - 32 - 37 - 42 - 48	28 - 36 - 40 - 46 - 53
		Heating	dB(A)	19 - 25 - 30 - 37 - 44	19 - 25 - 30 - 37 - 44	29 - 35 - 40 - 45 - 50	29 - 35 - 40 - 45 - 50
	Sound Level (PWL)	Cooling	dB(A)	-	-	-	-
		Heating	dB(A)	-	-	-	-
Outdoor Unit	Dimensions	H*W*D	mm	550-800-285	550-800-285	714-800-2850	880-840-330
	Weight	kg	30	35	41	54	
	Air Volume	Cooling	m ³ /min	36.3	34.3	45.8	50.1
		Heating	m ³ /min	34.6	32.7	43.7	50.1
	Sound Level (SPL)	Cooling	dB(A)	45	48	48	49
		Heating	dB(A)	46	48	49	51
	Sound Level (PWL)	Cooling	dB(A)	59	59	64	65
		Heating	dB(A)	59	59	64	65
	Operating Current (Max)	A	6.8	8.5	13.5	14.8	
	Breaker Size	A	10	10	20	20	
Ext. Piping	Diameter	Liquid/Gas	mm	6.35/9.52	6.35/9.52	6.35/12.7	6.35/115.88
	Max.Length	Out-In	m	20	20	30	30
	Max.Height	Out-In	m	12	12	30	30
Guaranteed Operating Range (Outdoor)	Cooling	°C	-10 ~ +46	-10 ~ +46	-10 ~ +46	-10 ~ +46	
	Heating	°C	-15 ~ +24	-15 ~ +24	-15 ~ +24	-15 ~ +24	

(*1) Refrigerant leakage contributes to climate change. Refrigerant with lower global warming potential (GWP) would contribute less to global warming than a refrigerant with higher GWP, if leaked to the atmosphere. This appliance contains a refrigerant fluid with a GWP equal to 1975. This means that if 1 kg of this refrigerant fluid would be leaked to the atmosphere, the impact on global warming would be 1975 times higher than 1 kg of CO₂, over a period of 100 years. Never try to interfere with the refrigerant circuit yourself or disassemble the product yourself and always ask a professional.
The GWP of R410A is 2088 in the IPCC 4th Assessment Report.

(*2) Energy consumption based on standard test results. Actual energy consumption will depend on how the appliance is used and where it is located.

(*3) SH: Super High

(*4) SEER, SCOP and other related description are based on COMMISSION DELEGATED REGULATION (EU) No 626/2011. The temperature conditions for calculating SCOP are based on "Average Season".

MFZ-K SERIES

High Capacity, Energy Savings and a Design in Harmony with Living Spaces
Raise the Value of Your Room to the Next Level.

MFZ-KJ25/35/50VE2

R410A



Simple , Flat Design

Un... de a simple design with linear beauty, harmonised with all types of interiors.

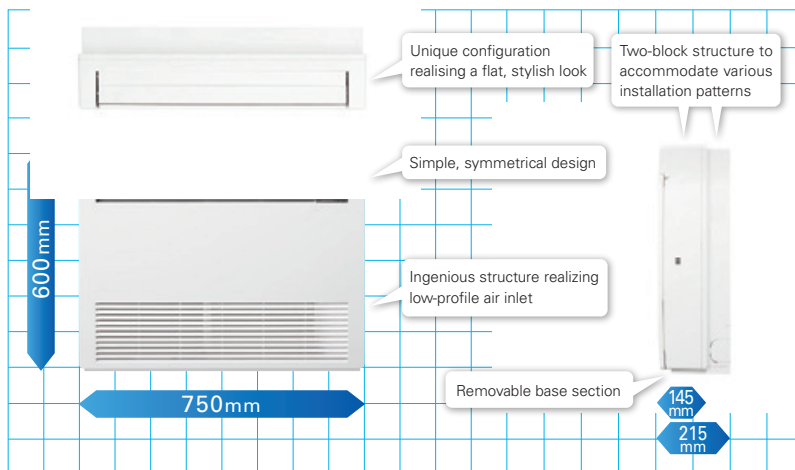

Images of installed unit

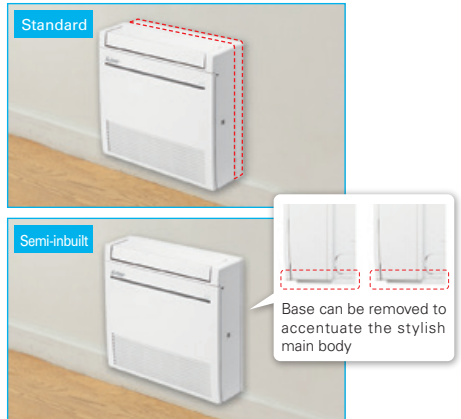

Multi-flow Vane

Three uniquely shaped vanes control the airflow and allow the freedom to customize comfort according to preferences.

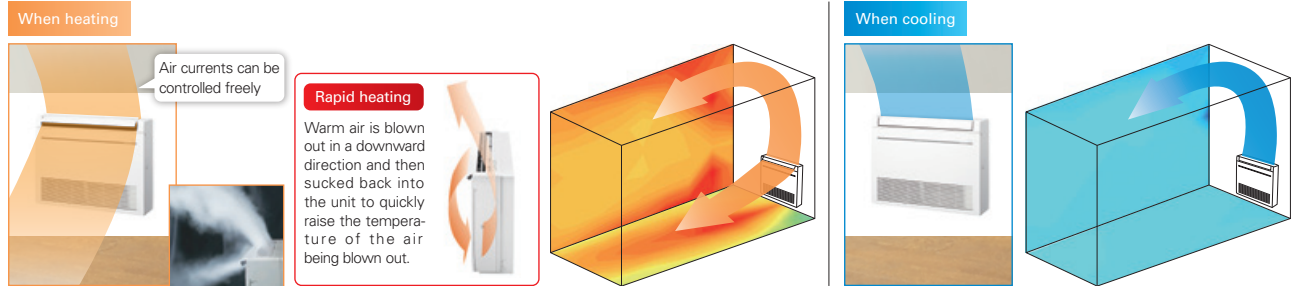

* The downward airflow is also possible as well as heating.

Excellent Energy-saving Performance



SEER A+++ (25) and SCOP A+ (25/35/50) ratings have been achieved through development focusing on compliance with European energy-related product (ErP) regulations.

Weekly Timer

(Introduced in response to market demand)

Temperature settings and On/Off control can be managed over a period of one week using the Weekly Timer. Up to eight setting patterns per calendar day are possible.

Quiet Operation

The indoor unit noise level is as low as 19dB for MFZ Series, offering a peaceful inside environment.

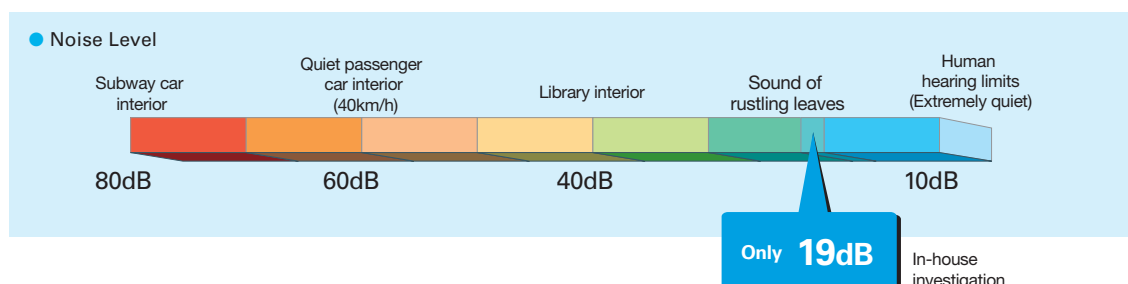

MFZ-KJ SERIES



Indoor Unit

R410A



MFZ-KJ25/35/50VE2

Outdoor Unit

R410A



MUFZ-KJ25/35VE



MUFZ-KJ50VE

Remote Controller



Type	Inverter Heat Pump					
Indoor Unit	MFZ-KJ25VE2		MFZ-KJ35VE2	MFZ-KJ50VE2		
Outdoor Unit	MUFZ-KJ25VE		MUFZ-KJ35VE	MUFZ-KJ50VE		
Refrigerant	R410A ^(*)		R410A ^(*)	R410A ^(*)		
Power Supply	Source	Outdoor power supply				
	Outdoor(V/Phase/Hz)	230 / Single / 50				
Cooling	Design load	kW	2.5	3.5	5.0	
	Annual electricity consumption ⁽²⁾	kWh/a	102	150	266	
	SEER ⁽⁴⁾		8.5	8.1	6.5	
	Capacity	Energy efficiency class		A+++	A++	A+
		Rated	kW	2.5	3.5	5.0
	Min-Max	kW	0.5 - 3.4	0.5 - 3.7	1.6 - 5.7	
	Total Input	Rated	kW	0.540	0.940	1.410
Heating (Average Season)	Design load	kW	3.4(-10°C)	3.5(-10°C)	4.4(-10°C)	
	Declared Capacity	at reference design temperature	kW	3.4(-10°C)	3.5(-10°C)	4.4(-10°C)
		at bivalent temperature	kW	3.4(-10°C)	3.5(-10°C)	4.4(-10°C)
		at operation limit temperature	kW	2.4(-15°C)	2.9(-15°C)	6.0(-15°C)
	Back up heating capacity	kW	0.0(-10°C)	0.0(-10°C)	0.0(-10°C)	
	Annual electricity consumption ⁽²⁾	kWh/a	1059	1110	1406	
	SCOP ⁽⁴⁾		4.5	4.4	4.3	
	Capacity	Energy efficiency class		A+	A+	A+
Rated		kW	3.4	4.3	6.0	
	Min-Max	kW	1.2 - 4.6	1.2 - 5.5	2.2 - 8.2	
	Total Input	Rated	kW	0.770	1.100	1.610
Operating Current (Max)	Input	A	9.4	9.4	14.0	
	Rated	kW	0.016	0.016	0.038	
Indoor Unit	Operating Current(Max)	A	0.17	0.17	0.34	
	Dimensions	H*W*D	mm	600-750-215	600-750-215	600-750-215
	Weight		kg	15	15	15
	Air Volume	Cooling	m ³ /min	3.9 - 4.9 - 5.9 - 7.1 - 8.2	3.9 - 4.9 - 5.9 - 7.1 - 8.2	5.6 - 6.7 - 8.0 - 9.3 - 10.6
		Heating	m ³ /min	3.9 - 5.1 - 6.2 - 7.7 - 9.7	3.9 - 5.1 - 6.2 - 7.7 - 9.7	6.0 - 7.4 - 9.4 - 11.6 - 14.0
	Sound Level (SPL) (SLo-Lo-Mid-Hi-SHi ⁽³⁾)	Cooling	dB(A)	20 - 25 - 30 - 35 - 39	20 - 25 - 30 - 35 - 39	27 - 31 - 35 - 39 - 44
		Heating	dB(A)	19 - 25 - 30 - 35 - 41	19 - 25 - 30 - 35 - 41	29 - 35 - 40 - 45 - 50
	Sound Level (PWL)	Cooling	dB(A)	49	50	56
		Heating	dB(A)	59	60	63
		Operating Current(Max)	A	9.2	9.2	13.6
	Breaker Size	A	10	10	16	
Ext. Piping	Diameter	Liquid/Gas	mm	6.35/9.52	6.35/9.52	6.35/12.7
	Max.Length	Out-In	m	20	20	30
	Max.Height	Out-In	m	12	12	15
Guaranteed Operating Range	Cooling	°C	-10 ~ +46	-10 ~ +46	-10 ~ +46	
	Heating	°C	-15 ~ +24	-15 ~ +24	-15 ~ +24	

^(*) Refrigerant leakage contributes to climate change. Refrigerant with lower global warming potential (GWP) would contribute less to global warming than a refrigerant with higher GWP, if leaked to the atmosphere. This appliance contains a refrigerant fluid with a GWP equal to 1975. This means that if 1 kg of this refrigerant fluid would be leaked to the atmosphere, the impact on global warming would be 1975 times higher than 1 kg of CO₂, over a period of 100 years. Never try to interfere with the refrigerant circuit yourself or disassemble the product yourself and always ask a professional.
The GWP of R410A is 2088 in the IPCC 4th Assessment Report.

⁽²⁾ Energy consumption based on standard test results. Actual energy consumption will depend on how the appliance is used and where it is located.

⁽³⁾ SHi: Super High

⁽⁴⁾ SEER, SCOP and other related description are based on COMMISSION DELEGATED REGULATION (EU) No 626/2011. The temperature conditions for calculating SCOP are based on "Average Season".

MLZ SERIES

Introducing a new type of ceiling cassette for the Multi-Split Series with streamlined interior dimensions and a sharp, sleek appearance.

R32
R410A
Multi

MLZ-KP25/35/50VF



GOOD DESIGN



reddot award 2018 winner



Slim Design

Industry leading slim body realized a simple design with linear beauty.

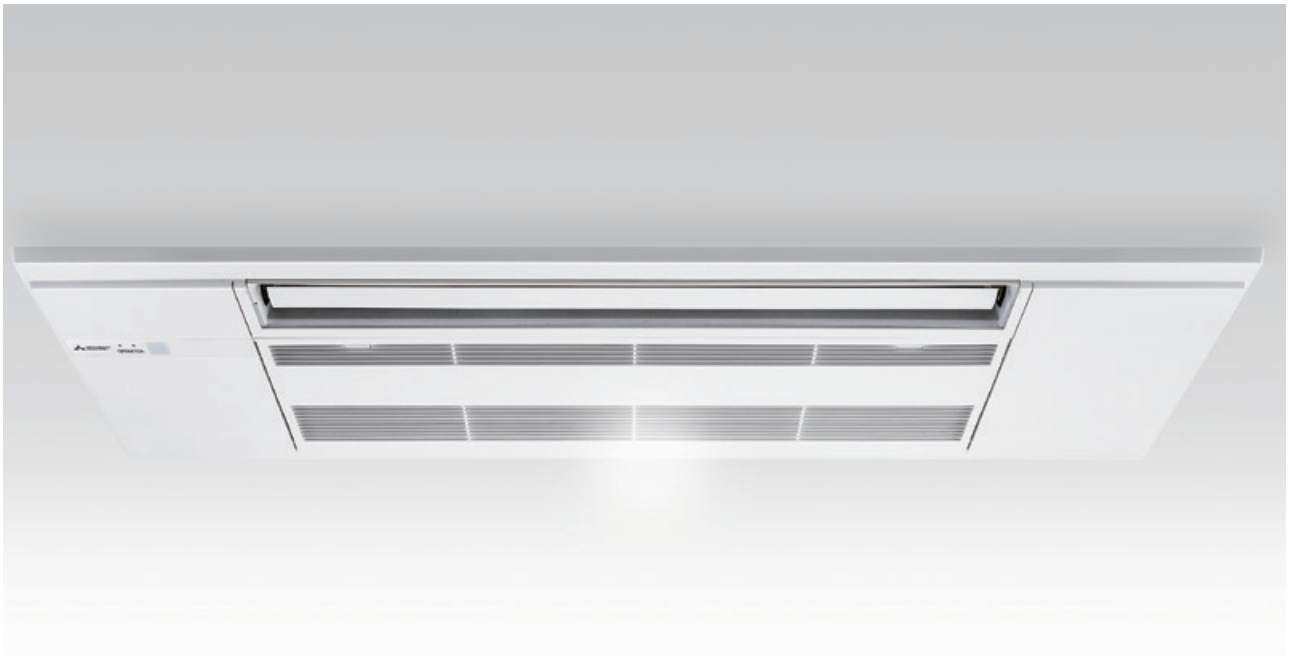

Ceiling Mounted

Installing the ceiling-mounted MLZ Series unit in a room creates a more spacious feel that enhances room comfort. This overhead format is also an excellent solution when lighting equipment is installed at the centre of the room and fixtures such as book shelves are mounted on wall surfaces.

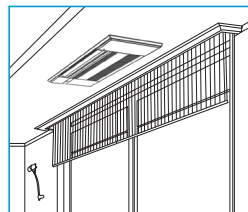

Slim Body

The new units are designed with a slim body (only 185mm high), ensuring easy installation even when low ceiling cavities limit installation space. The need for ceiling cavity service space is also eliminated, further reducing the dimensions required for installation.



Set Airflow According to Ceiling Height

Dual-level airflow selection is engineered to accommodate specific ceiling heights. This is a key feature for adjusting airflow effectively when it is either too strong or too weak due to being mismatched with the height of the ceiling.

	25	35	50
Standard	2.4m	2.4m	2.4m
High ceiling	2.7m	2.7m	2.7m

Auto Vane Control

Outlet vanes can be moved left and right, and up and down using the remote controller. This improved airflow control feature solves the problem of drafts.

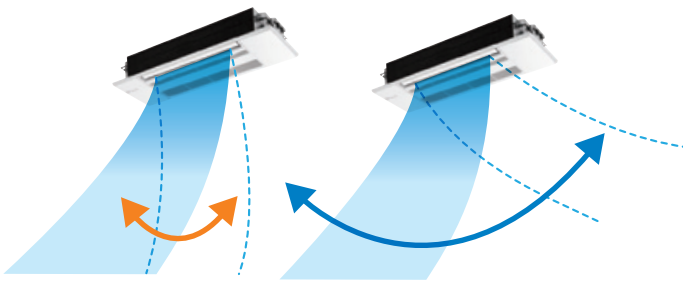

Up and Down

Left and Right

*Only available when Econo Cool is set.

Horizontal Airflow

The new airflow control completely eliminates that uncomfortable drafty-feeling with the introduction of a horizontal airflow that spreads across the ceiling. The ideal airflow for offices and restaurants.

[Horizontal Airflow]
Model name: MLZ-KP35VF
Ceiling height: 2.4m
Model: Cooling

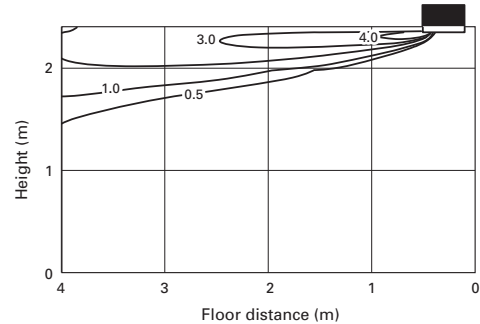

Weekly Timer Built-in Weekly Timer Function

Easily set desired temperatures and operation ON/OFF times to match lifestyle patterns. Reduce wasted energy consumption by using the timer to prevent forgetting to turn off the unit and eliminate temperature setting adjustments.

Example Operation Pattern (Winter/Heating mode)

	Mon.	Tues.	Wed.	Thurs.	Fri.	Sat.	Sun.
6:00	ON 20°C	ON 20°C	ON 20°C	ON 20°C	ON 20°C	ON 20°C	ON 20°C
8:00	Automatically changes to high-power operation at wake-up time						
10:00	OFF	OFF	OFF	OFF	OFF	ON 18°C	ON 18°C
12:00	Automatically turned off during work hours					Midday is warmer, so the temperature is set lower	
14:00							
16:00							
18:00	ON 22°C	ON 22°C	ON 22°C	ON 22°C	ON 22°C	ON 22°C	ON 22°C
20:00	Automatically turns on, synchronized with arrival at home					Automatically raises temperature setting to match time when outside-air temperature is low	
22:00							
(during sleeping hours)	ON 18°C	ON 18°C	ON 18°C	ON 18°C	ON 18°C	ON 10°C	ON 10°C
	Automatically lowers temperature at bedtime for energy-saving operation at night						

Settings

Pattern Settings: Input up to four settings for each day

Settings: •Start/Stop operation •Temperature setting *The operation mode cannot be set.

Easy set-up using dedicated buttons



The remote controller is equipped with buttons that are used exclusively for setting the Weekly Timer. Setting operation patterns is easy and quick.



How to set the Weekly Timer

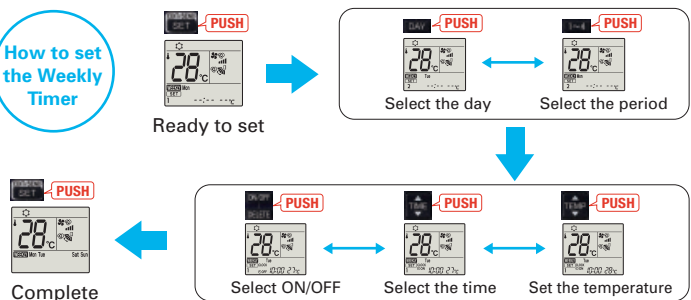

- Start by pushing the "SET" button and follow the instructions to set the desired patterns. Once all of the desired patterns are input, point the top end of the remote controller at the indoor unit and push the "SET" button one more time. (Push the "SET" button only after inputting all of the desired patterns into the remote controller memory. Pushing the "CANCEL" button will end the set-up process without sending the operation patterns to the indoor unit.)
- It takes a few seconds to transmit the Weekly Timer operation patterns to the indoor unit. Please continue to point the remote controller at the indoor unit until all data has been sent.

Easy Installation

Industry leading Slim Body

Inovative size which enables to fold the refrigerant piping above the unit.

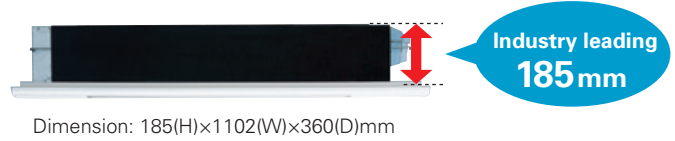

Temporary hanging hook

Work efficiency has improved during installation.

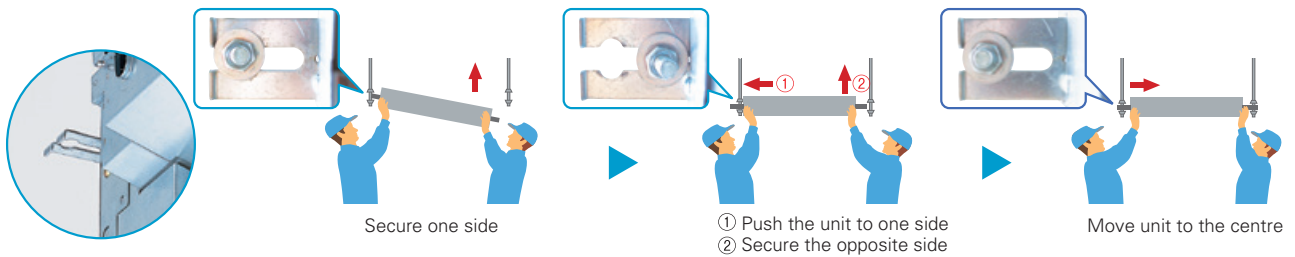

Drain Piping Supporters + Drain Cover

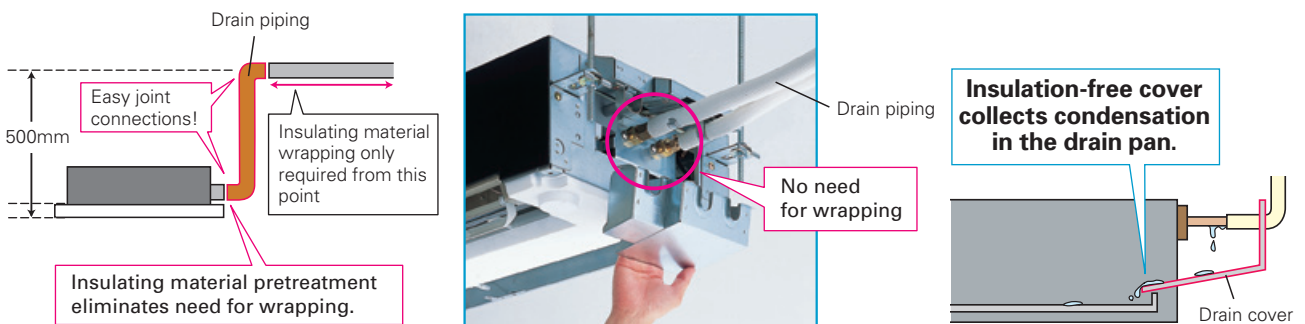

Wi-Fi Interface Installation (Optional)

The indoor unit panel is equipped with a Wi-Fi Interface pocket, contributing to the beautiful appearance, easy installation, and maintenance.

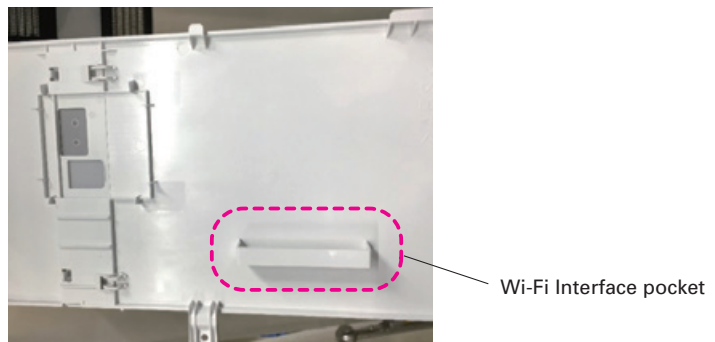

MLZ-KP SERIES



Indoor Unit



MLZ-KP25/35/50VF



Panel

MLP-444W

Outdoor Unit



SUZ-M25/35VA



SUZ-M50VA

Remote Controller



Enclosed in MLZ-KP



*optional



*optional



*optional



Type	Inverter Heat Pump					
Indoor Unit	MLZ-KP25VF		MLZ-KP35VF	MLZ-KP50VF		
Outdoor Unit	SUZ-M25VA		SUZ-M35VA	SUZ-M50VA		
Refrigerant	R32 ⁽¹⁾					
Power Source	Outdoor Power supply					
Outdoor (V / Phase / Hz)	230V / Single / 50Hz					
Cooling	Design load	kW	2.5	3.5	5.0	
	Annual electricity consumption ⁽²⁾	kWh/a	141	175	260	
	SEER ⁽³⁾		6.2	7.0	6.7	
	Capacity	Energy efficiency class		A++	A++	A++
		Rated	kW	2.5	3.5	5.0
Total Input	Min-Max	kW	1.4 - 3.2	0.8 - 3.9	1.7 - 5.6	
	Rated	kW	0.59	0.94	1.38	
Heating (Average Season)	Design load	kW	2.2	2.6	4.3	
	Declared Capacity	at reference design temperature	kW	2.0 (-10°C)	2.3 (-10°C)	3.8 (-10°C)
		at bivalent temperature	kW	2.0 (-7°C)	2.3 (-7°C)	3.8 (-7°C)
		at operation limit temperature	kW	2.0 (-10°C)	2.3 (-10°C)	3.8 (-10°C)
	Back up heating capacity	kW	0.2	0.3	0.5	
Annual electricity consumption ⁽²⁾	kWh/a	697	791	1397		
SCOP ⁽⁴⁾	Energy efficiency class		A+	A++	A+	
	Rated	kW	3.2	4.1	6.0	
Capacity	Min-Max	kW	1.4 - 4.2	1.1 - 4.9	1.7 - 7.2	
	Rated	kW	0.80	1.10	1.86	
Operating Current (Max)		A	7.2	8.9	13.9	
Indoor Unit	Input	Rated	kW	0.04	0.04	0.04
		Operating Current(Max)	A	0.40	0.40	0.40
	Dimensions	H*W*D	mm	185-1102-360	185-1102-360	185-1102-360
		Weight	kg	15.5	15.5	15.5
	Air Volume (SLo-Lo-Mid-Hi ⁽⁵⁾ (Dry/Wet))	Cooling	m ³ /min	6.0-7.2-8.0-8.8	6.0-7.3-8.4-9.4	6.0-8.3-9.8-11.4
		Heating	m ³ /min	6.0-7.0-8.2-9.2	6.0-7.7-8.8-9.9	6.0-8.8-10.3-11.8
	Sound Level (SPL) (SLo-Lo-Mid-Hi ⁽⁵⁾)	Cooling	dB(A)	27-31-34-38	27-32-36-40	29-36-41-47
		Heating	dB(A)	26-27-34-37	29-32-36-40	26-37-42-48
	Sound Level (PWL)	Cooling	dB(A)	52	53	59
		Heating	dB(A)	52	53	59
Panel	Dimensions	H*W*D	mm	24-1200-424	24-1200-424	
	Weight	kg	3.5	3.5	3.5	
	Dimensions	H*W*D	mm	550-800-285	550-800-285	
Outdoor Unit	Weight	kg	30	35	41	
		Air Volume	Cooling	m ³ /min	36.3	34.3
	Sound Level (SPL)	Heating	m ³ /min	34.6	32.7	43.7
		Cooling	dB(A)	45	48	48
	Sound Level (PWL)	Heating	dB(A)	46	48	49
		Cooling	dB(A)	59	59	64
	Operating Current (Max)	A	6.8	8.5	13.5	
	Breaker Size	A	10	10	20	
	Ext. Piping	Diameter	Liquid/Gas	mm	6.35/9.52	6.35/12.7
		Max.Length	Out-In	m	20	30
Max.Height		Out-In	m	12	30	
Guaranteed Operating Range (Outdoor)	Cooling	°C	-10~+46	-10~+46	-15~+46	
	Heating	°C	-10~+24	-10~+24	-10~+24	

(1) Refrigerant leakage contributes to climate change. Refrigerant with lower global warming potential (GWP) would contribute less to global warming than a refrigerant with higher GWP, if leaked to the atmosphere. This appliance contains a refrigerant fluid with a GWP equal to 1975. This means that if 1 kg of this refrigerant fluid would be leaked to the atmosphere, the impact on global warming would be 1975 times higher than 1 kg of CO₂, over a period of 100 years. Never try to interfere with the refrigerant circuit yourself or disassemble the product yourself and always ask a professional.

The GWP of R410A is 2088 in the IPCC 4th Assessment Report.

(2) Energy consumption based on standard test results. Actual energy consumption will depend on how the appliance is used and where it is located.

(3) SH: Super High

(4) SEER, SCOP and other related description are based on COMMISSION DELEGATED REGULATION (EU) No.626/2011. The temperature conditions for calculating SCOP are based on "Average Season".

Specification on Warmer/Colder Condition

Type		Inverter Heat Pump								
Indoor Unit		MSZ-LN25VG		MSZ-LN35VG		MSZ-LN50VG		MSZ-LN60VG		
Outdoor Unit		MUZ-LN25VG	MUZ-LN25VGHZ	MUZ-LN35VG	MUZ-LN35VGHZ	MUZ-LN50VG	MUZ-LN50VGHZ	MUZ-LN60VG		
Refrigerant		R32 ^(*)								
Cooling	Design load	kW	2.5	2.5	3.5	3.5	5.0	5.0	6.1	
	Annual electricity consumption ⁽²⁾	kWh/a	83	83	128	130	205	230	285	
	SEER		10.5	10.5	9.5	9.4	8.5	7.6	7.5	
		Energy efficiency class	A+++	A+++	A+++	A+++	A+++	A++	A++	
Heating (Warmer Season)	Design load	kW	1.7 (2°C)	1.8 (2°C)	2.0 (2°C)	2.2 (2°C)	2.5 (2°C)	3.3 (2°C)	3.3 (2°C)	
	Declared Capacity	at reference design temperature	kW	1.7 (2°C)	1.8 (2°C)	2.0 (2°C)	2.2 (2°C)	2.5 (2°C)	3.3 (2°C)	3.3 (2°C)
		at bivalent temperature	kW	1.7 (2°C)	1.8 (2°C)	2.0 (2°C)	2.2 (2°C)	2.5 (2°C)	3.3 (2°C)	3.3 (2°C)
		at operation limit temperature	kW	2.5 (-15°C)	2.3 (-25°C)	3.2 (-15°C)	3.1 (-25°C)	4.2 (-15°C)	4.7 (-25°C)	6.0 (-15°C)
	Back up heating capacity	kW	0.0 (2°C)	0.0 (2°C)	0.0 (2°C)	0.0 (2°C)	0.0 (2°C)	0.0 (2°C)	0.0 (2°C)	
	Annual electricity consumption ⁽²⁾	kWh/a	358	374	412	466	602	779	779	
	SCOP		6.6	6.7	6.7	6.6	5.8	5.9	5.9	
		Energy efficiency class	A+++	A+++	A+++	A+++	A+++	A+++		
Heating (Colder Season)	Design load	kW	—	4.7 (-22°C)	—	5.9 (-22°C)	—	8.8 (-22°C)	—	
	Declared Capacity	at reference design temperature	kW	—	2.6 (-22°C)	—	3.4 (-22°C)	—	5.1 (-22°C)	—
		at bivalent temperature	kW	—	3.2 (-10°C)	—	4.0 (-10°C)	—	6.0 (-10°C)	—
		at operation limit temperature	kW	—	2.3 (-25°C)	—	3.1 (-25°C)	—	4.7 (-25°C)	—
	Back up heating capacity	kW	—	2.1 (-22°C)	—	2.5 (-22°C)	—	3.7 (-22°C)	—	
	Annual electricity consumption ⁽²⁾	kWh/a	—	2425	—	3075	—	5340	—	
	SCOP		—	4.0	—	4.0	—	3.4	—	
		Energy efficiency class	—	A+	—	A+	—	A		

Type		Inverter Heat Pump									
Indoor Unit		MSZ-AP25VG		MSZ-AP35VG		MSZ-AP42VG		MSZ-AP50VG			
Outdoor Unit		MUZ-AP25VG	MUZ-AP25VGHZ	MUZ-AP35VG	MUZ-AP35VGHZ	MUZ-AP42VG	MUZ-AP42VGHZ	MUZ-AP50VG	MUZ-AP50VGHZ		
Refrigerant		R32 ^(*)									
Cooling	Design load	kW	2.5	2.5	3.5	3.5	4.2	4.2	5.0	5.0	
	Annual electricity consumption ⁽²⁾	kWh/a	116	116	171	171	196	196	246	246	
	SEER		7.6	7.6	7.2	7.2	7.5	7.5	7.2	7.2	
		Energy efficiency class	A++	A++	A++	A++	A++	A++	A++	A++	
Heating (Warmer Season)	Design load	kW	1.3 (2°C)	1.3 (2°C)	1.6 (2°C)	1.6 (2°C)	2.1 (2°C)	2.1 (2°C)	2.3 (2°C)	2.3 (2°C)	
	Declared Capacity	at reference design temperature	kW	1.3 (2°C)	1.3 (2°C)	1.6 (2°C)	1.6 (2°C)	2.1 (2°C)	2.1 (2°C)	2.3 (2°C)	2.3 (2°C)
		at bivalent temperature	kW	1.3 (2°C)	1.3 (2°C)	1.6 (2°C)	1.6 (2°C)	2.1 (2°C)	2.1 (2°C)	2.3 (2°C)	2.3 (2°C)
		at operation limit temperature	kW	2.0 (-15°C)	1.6 (-20°C)	2.2 (-15°C)	1.6 (-20°C)	3.4 (-15°C)	2.2 (-20°C)	3.4 (-15°C)	2.3 (-20°C)
	Back up heating capacity	kW	0.0 (2°C)	0.0 (2°C)	0.0 (2°C)	0.0 (2°C)	0.0 (2°C)	0.0 (2°C)	0.0 (2°C)	0.0 (2°C)	
	Annual electricity consumption ⁽²⁾	kWh/a	337	337	923 / 418	417	507	507	563	563	
	SCOP		5.4	5.4	5.4	5.4	5.8	5.8	5.7	5.7	
		Energy efficiency class	A+++	A+++	A+++	A+++	A+++	A+++	A+++		

Type		Inverter Heat Pump							
Indoor Unit		MSZ-FH25VE2		MSZ-FH35VE2		MSZ-FH50VE2			
Outdoor Unit		MUZ-FH25VE	MUZ-FH25VEHZ	MUZ-FH35VE	MUZ-FH35VEHZ	MUZ-FH50VE	MUZ-FH50VEHZ		
Refrigerant		R410A ^(*)							
Cooling	Design load	kW	2.5	2.5	3.5	3.5	5.0	5.0	
	Annual electricity consumption ⁽²⁾	kWh/a	96	96	138	138	244	244	
	SEER		9.1	9.1	8.9	8.9	7.2	7.2	
		Energy efficiency class	A+++	A+++	A+++	A+++	A++	A++	
Heating (Warmer Season)	Design load	kW	1.7 (2°C)	1.8 (2°C)	2.0 (2°C)	2.2 (2°C)	2.5 (2°C)	3.3 (2°C)	
	Declared Capacity	at reference design temperature	kW	1.7 (2°C)	1.8 (2°C)	2.0 (2°C)	2.2 (2°C)	2.5 (2°C)	3.3 (2°C)
		at bivalent temperature	kW	1.7 (2°C)	1.8 (2°C)	2.0 (2°C)	2.2 (2°C)	2.5 (2°C)	3.3 (2°C)
		at operation limit temperature	kW	2.5 (-15°C)	1.7 (-25°C)	3.2 (-15°C)	2.6 (-25°C)	5.2 (-15°C)	3.8 (-25°C)
	Back up heating capacity	kW	0.0 (2°C)	0.0 (2°C)	0.0 (2°C)	0.0 (2°C)	0.0 (2°C)	0.0 (2°C)	
	Annual electricity consumption ⁽²⁾	kWh/a	376	397	429	471	614	787	
	SCOP		6.3	6.3	6.5	4.8 / 6.5	5.7	5.9	
		Energy efficiency class	A+++	A+++	A+++	A+++	A+++		

Type		Inverter Heat Pump							
Indoor Unit		MSZ-EF25VG		MSZ-EF35VG		MSZ-EF42VG			
Outdoor Unit		MUZ-EF25VG	MUZ-EF25VGHZ	MUZ-EF35VG	MUZ-EF35VGHZ	MUZ-EF42VG	MUZ-EF50VG		
Refrigerant		R32 ^(*)							
Cooling	Design load	kW	2.5	2.5	3.5	3.5	4.2	5.0	
	Annual electricity consumption ⁽²⁾	kWh/a	96	96	139	139	186	233	
	SEER		9.1	9.1	8.8	8.8	7.9	7.5	
		Energy efficiency class	A+++	A+++	A+++	A+++	A++	A++	
Heating (Warmer Season)	Design load	kW	1.3 (2°C)	1.3 (2°C)	1.6 (2°C)	1.6 (2°C)	2.1 (2°C)	2.3 (2°C)	
	Declared Capacity	at reference design temperature	kW	1.3 (2°C)	1.3 (2°C)	1.6 (2°C)	1.6 (2°C)	2.1 (2°C)	2.3 (2°C)
		at bivalent temperature	kW	1.3 (2°C)	1.3 (2°C)	1.6 (2°C)	1.6 (2°C)	2.1 (2°C)	2.3 (2°C)
		at operation limit temperature	kW	2.0 (-15°C)	2.0 (-15°C)	2.4 (-15°C)	2.4 (-15°C)	3.4 (-15°C)	3.5 (-15°C)
	Back up heating capacity	kW	0.0 (2°C)	0.0 (2°C)	0.0 (2°C)	0.0 (2°C)	0.0 (2°C)	0.0 (2°C)	
	Annual electricity consumption ⁽²⁾	kWh/a	311	311	398	398	489	595	
	SCOP		5.9	5.9	5.6	5.6	6.0	5.4	
		Energy efficiency class	A+++	A+++	A+++	A+++	A+++		

Type		Inverter Heat Pump									
Indoor Unit		MSZ-SF25VE3		MSZ-SF35VE3		MSZ-SF42VE3		MSZ-SF50VE3			
Outdoor Unit		MUZ-SF25VE	MUZ-SF25VEHZ	MUZ-SF35VE	MUZ-SF35VEHZ	MUZ-SF42VE	MUZ-SF42VEHZ	MUZ-SF50VE	MUZ-SF50VEHZ		
Refrigerant		R410A ^(*)									
Cooling	Design load	kW	2.5	2.5	3.5	3.5	4.2	4.2	5.0	5.0	
	Annual electricity consumption ⁽²⁾	kWh/a	116	116	171	171	196	196	246	246	
	SEER		7.6	7.6	7.2	7.2	7.5	7.5	7.2	7.2	
		Energy efficiency class	A++	A++	A++	A++	A++	A++	A++	A++	
Heating (Warmer Season)	Design load	kW	1.3 (2°C)	1.3 (2°C)	1.6 (2°C)	1.6 (2°C)	2.1 (2°C)	2.1 (2°C)	2.3 (2°C)	2.3 (2°C)	
	Declared Capacity	at reference design temperature	kW	1.3 (2°C)	1.3 (2°C)	1.6 (2°C)	1.6 (2°C)	2.1 (2°C)	2.1 (2°C)	2.3 (2°C)	2.3 (2°C)
		at bivalent temperature	kW	1.3 (2°C)	1.3 (2°C)	1.6 (2°C)	1.6 (2°C)	2.1 (2°C)	2.1 (2°C)	2.3 (2°C)	2.3 (2°C)
		at operation limit temperature	kW	2.0 (-15°C)	1.6 (-20°C)	2.2 (-15°C)	1.6 (-20°C)	3.4 (-15°C)	2.2 (-20°C)	3.4 (-15°C)	2.3 (-20°C)
	Back up heating capacity	kW	0.0 (2°C)	0.0 (2°C)	0.0 (2°C)	0.0 (2°C)	0.0 (2°C)	0.0 (2°C)	0.0 (2°C)	0.0 (2°C)	
	Annual electricity consumption ⁽²⁾	kWh/a	337	337	923 / 418	417	507	507	563	563	
	SCOP		5.4	5.4	5.4	5.4	5.8	5.8	5.7	5.7	
		Energy efficiency class	A+++	A+++	A+++	A+++	A+++	A+++	A+++		

Type		Inverter Heat Pump					
Indoor Unit		MSZ-GF60VE2	MSZ-GF71VE2	MSZ-WN25VA	MSZ-WN35VA		
Outdoor Unit		MUZ-GF60VE	MUZ-GF71VE	MUZ-WN25VA	MUZ-WN35VA		
Refrigerant		R410A ⁽¹⁾					
Cooling	Design load	kW	6.1	7.1	2.5	3.1	
	Annual electricity consumption ⁽²⁾	kWh/a	311	364	141	173	
	SEER		6.8	6.8	6.2	6.2	
		Energy efficiency class	A++	A++	A++	A++	
Heating (Warmer Season)	Design load	kW	2.5 (2°C)	3.7 (2°C)	1.1 (2°C)	1.3 (2°C)	
	Declared Capacity	at reference design temperature	kW	2.5 (2°C)	3.7 (2°C)	1.1 (2°C)	1.3 (2°C)
		at bivalent temperature	kW	2.5 (2°C)	3.7 (2°C)	1.1 (2°C)	1.3 (2°C)
		at operation limit temperature	kW	3.7 (-15°C)	5.4 (-15°C)	1.6 (-15°C)	2.0 (-15°C)
	Back up heating capacity	kW	0.0 (2°C)	0.0 (2°C)	0.0 (2°C)	0.0 (2°C)	
	Annual electricity consumption ⁽²⁾	kWh/a	664	963	304	362	
SCOP ⁽⁴⁾		5.3	5.4	5.0	5.0		
		Energy efficiency class	A+++	A+++	A++	A++	

Type		Inverter Heat Pump								
Indoor Unit		MSZ-HJ25VA	MSZ-HJ35VA	MSZ-HJ50VA	MSZ-HJ60VA	MSZ-HJ71VA	MSZ-DM25VA	MSZ-DM35VA		
Outdoor Unit		MUZ-HJ25VA	MUZ-HJ35VA	MUZ-HJ50VA	MUZ-HJ60VA	MUZ-HJ71VA	MUZ-DM25VA	MUZ-DM35VA		
Refrigerant		R410A ⁽¹⁾								
Cooling	Design load	kW	2.5	3.1	5.0	6.1	7.1	2.5	3.1	
	Annual electricity consumption ⁽²⁾	kWh/a	171	212	292	354	441	149	190	
	SEER		5.1	5.1	6.0	6.0	5.6	5.8	5.7	
		Energy efficiency class	A	A	A+	A+	A+	A+		
Heating (Warmer Season)	Design load	kW	1.1 (2°C)	1.3 (2°C)	2.1 (2°C)	2.5 (2°C)	2.9 (2°C)	1.1 (2°C)	1.3 (2°C)	
	Declared Capacity	at reference design temperature	kW	1.1 (2°C)	1.3 (2°C)	2.1 (2°C)	2.5 (2°C)	2.9 (2°C)	1.1 (2°C)	1.3 (2°C)
		at bivalent temperature	kW	1.1 (2°C)	1.3 (2°C)	2.1 (2°C)	2.5 (2°C)	2.9 (2°C)	1.1 (2°C)	1.3 (2°C)
		at operation limit temperature	kW	1.9 (-10°C)	2.4 (-10°C)	3.8 (-10°C)	4.6 (-10°C)	5.4 (-10°C)	1.9 (-10°C)	2.4 (-10°C)
	Back up heating capacity	kW	0.0 (2°C)	0.0 (2°C)	0.0 (2°C)	0.0 (2°C)	0.0 (2°C)	0.0 (2°C)	0.0 (2°C)	
	Annual electricity consumption ⁽²⁾	kWh/a	356	426	539	674	813	325	386	
SCOP		4.3	4.3	5.5	5.1	4.9	4.7	4.7		
		Energy efficiency class	A+	A+	A+++	A+++	A++	A++		

Type		Inverter Heat Pump					
Indoor Unit		MSZ-HR25VF	MSZ-HR35VF	MSZ-HR42VF	MSZ-HR50VF		
Outdoor Unit		MUZ-HR25VF	MUZ-HR35VF	MUZ-HR42VF	MUZ-HR50VF		
Refrigerant		R32 ⁽³⁾					
Cooling	Design load	kW	2.5	3.4	4.2	5.0	
	Annual electricity consumption ⁽²⁾	kWh/a	141	191	226	269	
	SEER		6.2	6.2	6.5	6.5	
		Energy efficiency class	A++	A++	A++	A++	
Heating (Warmer Season)	Design load	kW	1.1 (2°C)	1.3 (2°C)	1.6 (2°C)	2.1 (2°C)	
	Declared Capacity	at reference design temperature	kW	1.1 (2°C)	1.3 (2°C)	1.6 (2°C)	2.1 (2°C)
		at bivalent temperature	kW	1.1 (2°C)	1.3 (2°C)	1.6 (2°C)	2.1 (2°C)
		at operation limit temperature	kW	1.9 (-10°C)	2.4 (-10°C)	2.9 (-10°C)	3.8 (-10°C)
	Back up heating capacity	kW	0.0 (2°C)	0.0 (2°C)	0.0 (2°C)	0.0 (2°C)	
	Annual electricity consumption ⁽²⁾	kWh/a	289	344	427	558	
SCOP		5.3	5.2	5.2	5.2		
		Energy efficiency class	A+++	A+++	A+++	A+++	

Type		Inverter Heat Pump							
Indoor Unit		MFZ-KJ25VE2		MFZ-KJ35VE2		MFZ-KJ50VE2			
Outdoor Unit		MUFZ-KJ25VE	MUFZ-KJ25VEHZ	MUFZ-KJ35VE	MUFZ-KJ35VEHZ	MUFZ-KJ50VE	MUFZ-KJ50VEHZ		
Refrigerant		R410A ⁽¹⁾							
Cooling	Design load	kW	2.5	2.5	3.5	3.5	5.0	5.0	
	Annual electricity consumption ⁽²⁾	kWh/a	102	102	150	150	266	266	
	SEER		8.5	8.5	8.1	8.1	6.5	6.5	
		Energy efficiency class	A+++	A+++	A++	A++	A++	A++	
Heating (Warmer Season)	Design load	kW	1.9 (2°C)	1.9 (2°C)	1.9 (2°C)	2.0 (2°C)	2.4 (2°C)	2.5 (2°C)	
	Declared Capacity	at reference design temperature	kW	1.9 (2°C)	1.9 (2°C)	1.9 (2°C)	2.0 (2°C)	2.4 (2°C)	2.5 (2°C)
		at bivalent temperature	kW	1.9 (2°C)	1.9 (2°C)	1.9 (2°C)	2.0 (2°C)	2.4 (2°C)	2.5 (2°C)
		at operation limit temperature	kW	2.4 (-15°C)	1.6 (-25°C)	2.9 (-15°C)	2.3 (-25°C)	6.0 (-15°C)	3.3 (-25°C)
	Back up heating capacity	kW	0.0 (2°C)	0.0 (2°C)	0.0 (2°C)	0.0 (2°C)	0.0 (2°C)	0.0 (2°C)	
	Annual electricity consumption ⁽²⁾	kWh/a	511	490	499	510	579	603	
SCOP		5.1	5.4	5.3	5.4	5.8	5.7		
		Energy efficiency class	A+++	A+++	A+++	A+++	A+++	A+++	

(1) Refrigerant leakage contributes to climate change. Refrigerant with lower global warming potential (GWP) would contribute less to global warming than a refrigerant with higher GWP, if leaked to the atmosphere. This appliance contains a refrigerant fluid with a GWP equal to 1975. This means that if 1 kg of this refrigerant fluid would be leaked to the atmosphere, the impact on global warming would be 1975 times higher than 1 kg of CO₂, over a period of 100 years. Never try to interfere with the refrigerant circuit yourself or disassemble the product yourself and always ask a professional.

(2) Energy consumption based on standard test results. Actual energy consumption will depend on how the appliance is used and where it is located.

(3) Refrigerant leakage contributes to climate change. Refrigerant with lower global warming potential (GWP) would contribute less to global warming than a refrigerant with higher GWP, if leaked to the atmosphere. This appliance contains a refrigerant fluid with a GWP equal to 550. This means that if 1 kg of this refrigerant fluid would be leaked to the atmosphere, the impact on global warming would be 550 times higher than 1 kg of CO₂, over a period of 100 years. Never try to interfere with the refrigerant circuit yourself or disassemble the product yourself and always ask a professional.

S

SERIES



SELECTION

Series line-up consists of two types of indoor units.
Choose the model that best matches room conditions.

SELECT INDOOR UNIT

Select the optimal unit and capacity required to match room construction and air conditioning requirements.

R32

R410A





GOOD DESIGN

Units without Remote Controller

SLZ-M15FA (Multi split series connection only)

SLZ-M25FA

SLZ-M35FA

SLZ-M50FA

SLZ-M60FA

Panel

Panel	With Signal Receiver	With 3D i-see Sensor	With Wireless Remote Controller
SLP-2FA			
SLP-2FAL	✓		
SLP-2FAE		✓	
SLP-2FALE	✓	✓	
SLP-2FALM	✓		✓
SLP-2FALME	✓	✓	✓

R32

R410A



Units without Remote Controller

SEZ-M25DA

SEZ-M35DA

SEZ-M50DA

SEZ-M60DA

SEZ-M71DA

Units with Wireless Remote Controller

SEZ-M25DAL

SEZ-M35DAL

SEZ-M50DAL

SEZ-M60DAL

SEZ-M71DAL

SELECT OUTDOOR UNIT

There is one outdoor unit for respective indoor units.

R32



SUZ-M25/35VA

R32



SUZ-M50VA

R32



SUZ-M60/71VA

R410A



SUZ-KA25/35VA6

R410A



SUZ-KA50/60/71VA6

* To confirm compatibility with the MXZ Series multi-type system, refer to the MXZ Series page.

SLZ SERIES

R32
R410A

SLZ-M15/25/35/50/60FA



Compact, lightweight ceiling cassette units with 4-way air outlets provide maximum comfort by evenly distributing airflow throughout the entire room.

New lineup

1.5kW has been introduced for multi connection. The diverse selection enables the best solution for both customer and location.

Capacity	15	25	35	50	60
SLZ-KF		✓	✓	✓	✓
SLZ-M	✓	✓	✓	✓	✓

Beautiful design

The straight-line form introduced has resulted in a beautiful square design. Its high affinity ensures the ability to blend in seamlessly with any interior. The indoor unit is an ideal match for office or store use. Of course, design matched 2x2 (600mm*600mm) ceiling construction specifications.

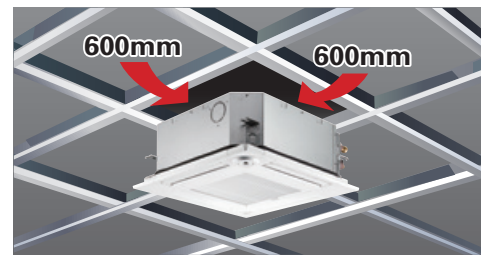

The height above ceiling of 245mm

The height above ceiling of 245mm enables fitting into narrow ceiling space. Installation is simple, even when the ceiling spaces are narrow to make the ceilings higher. Of course, in addition to our products, replacing competitors' product is simplified too.

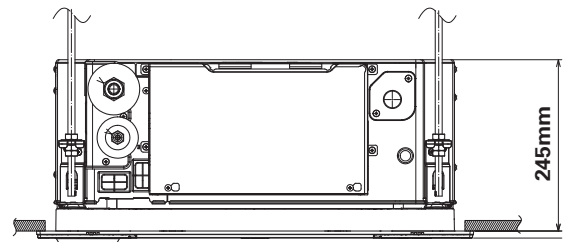

Energy-saving Performance*

The energy-saving performance achieved A⁺⁺ in SEER and A⁺ in SCOP.

*In case of connecting with SUZ-KA-VA6

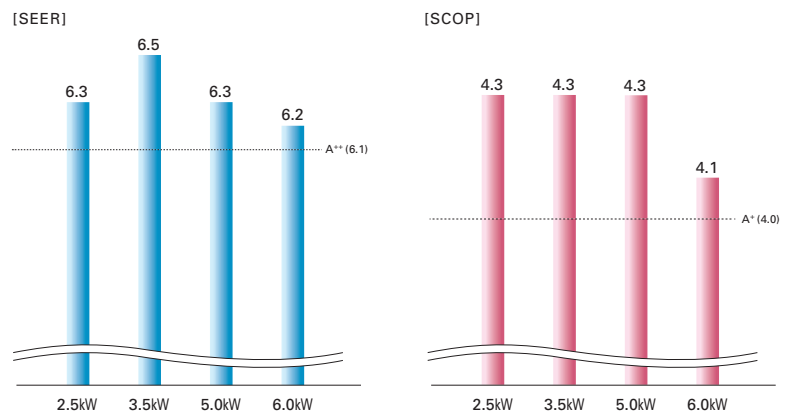

Quietness

Low sound level has been realized by introduction of 3D turbo fan. New SLZ can give users quieter and more comfortable room condition.



Horizontal Airflow

The new airflow control completely eliminates that uncomfortable drafty-feeling with the introduction of a horizontal airflow that spreads across the ceiling. The ideal airflow for offices and restaurants.

[Airflow distribution]*
SLZ-M60FA
Flow angle, cooling at 20°C (ceiling height 2.7m)

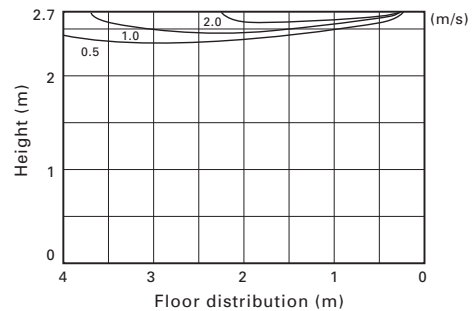

*Vane angle: Horizontal

Easy installation

Temporary hanging hook

The structure of the panel has been revised and is now equipped with a temporary hanging hook. This has improved work efficiency during temporary panel installation.

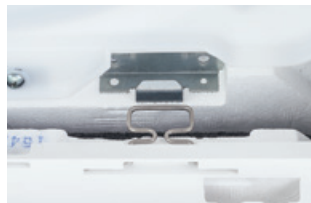

No need to remove screws

Installation is possible without removing the screws for control box simply loosen them. This eliminates the risk of losing screws.

■ Corner panel

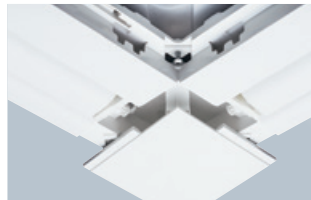

■ Control box cover



Drain lift

As the result of using a larger drain pan, the maximum drain lifting height has been up to 850mm, greatly enhancing construction flexibility compared to the existing model.

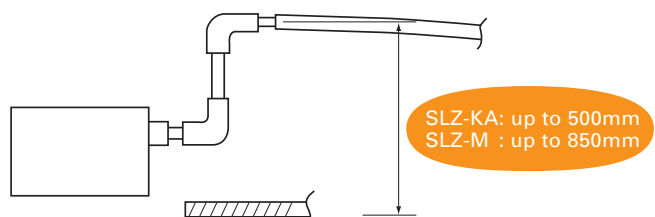

Detects number of people

Room occupancy energy-saving mode

The 3D i-see Sensor detects the number of people in the room. It then calculates the occupancy rate based on the maximum number of people in the room up to that point in time in order to save air-conditioning power. When the occupancy rate is approximately 30%, air-conditioning power equivalent to 1°C during both cooling and heating operation is saved. The temperature is controlled according to the number of people.

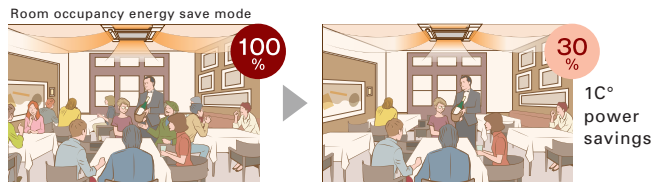

No occupancy energy-saving mode

When 3D i-see Sensor detects that no one is in the room, the system is switched to a pre-set power-saving mode. If the room remains unoccupied for more than 60min, air-conditioning power equivalent to 2°C during both cooling and heating operation is saved. This contributes to preventing waste in terms of heating and cooling.

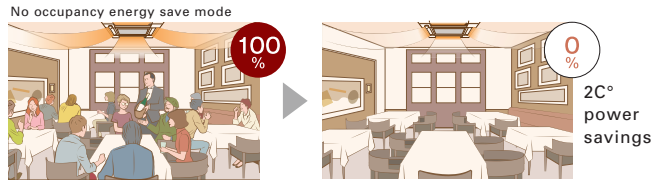

No occupancy Auto-OFF mode*

When the room remains unoccupied for a pre-set period of time, the air conditioner turns off automatically, thereby providing even greater power savings. The time until operation is stopped can be set in intervals of 10min, ranging from 60 to 180 min.

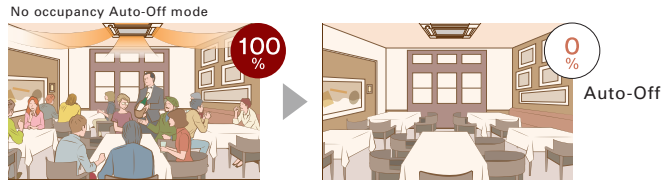

* When MA Remote Controller is used to control multiple refrigerant systems, "No occupancy Auto-OFF mode" cannot be used.

*PAR-40MAA is required for each setting

Detects people's position

Direct/Indirect settings*

Some people do not like the feel of wind, some want to be warm from head to toe. People's likes and dislikes vary. With the 3D i-see Sensor, it is possible to choose to block or not block to the wind for each vane.

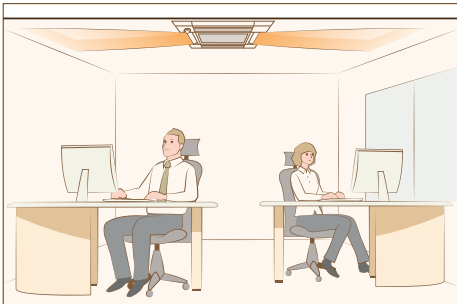

*PAR-40MAA or PAR-SL100A-E is required for each setting.

Seasonal airflow*

<When cooling>

Saves energy while keeping a comfortable effective temperature by automatically switching between ventilation and cooling. When a pre-set temperature is reached, the air conditioning unit switches to swing fan operation to maintain the effective temperature. This clever function contributes to keeping a comfortable coolness.

<When heating>

The air conditioning unit automatically switches between circulator and heating. Wasted heat that accumulates near the ceiling is reused via circulation. When a pre-set temperature is reached the air conditioner switches from heating to circulator and blows air in the horizontal direction. It pushes down the warm air that has gathered near the ceiling to people's height, thereby providing smart heating.

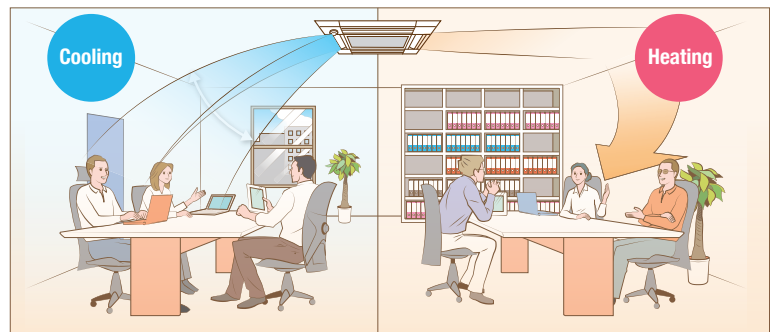

*PAR-40MAA is required for each setting.

Simultaneous Multi-system*

Multiple indoor units can be installed to match the room layout, ensuring comfort and coverage of the entire room. Connection of multiple cassettes to P Series power inverter outdoor units shown below is possible.

* Only for RA410A connection

Power Inverter Combination		SLZ-M35FA	SLZ-M50FA	SLZ-M60FA
PUHZ-ZRP71VHA2		Twin	—	—
	Distribution pipe	MSDD-50TR-E		
PUHZ-ZRP100V(Y)KA3		Triple	Twin	—
	Distribution pipe	MSDT-111R-E	MSDD-50TR-E	
PUHZ-ZRP125V(Y)KA3		Quadruple	Triple	Twin
	Distribution pipe	MSDF-1111R-E	MSDT-111R-E	MSDD-50TR-E
PUHZ-ZRP140V(Y)KA3		Quadruple	Triple	—
	Distribution pipe	MSDF-1111R-E	MSDT-111R-E	—

SLZ-M SERIES



Indoor Unit

R32
R410A



SLZ-M15/25/35/50/60FA

Outdoor Unit

R32



SUZ-M25/35VA

R32



SUZ-M50VA

R32



SUZ-M60VA

Panel

Panel	With Signal Receiver	With 3D i-see Sensor	With Wireless Remote Controller
SLP-2FA			
SLP-2FAL	✓		
SLP-2FAE		✓	
SLP-2FALE	✓	✓	
SLP-2FALM	✓		✓
SLP-2FALME	✓	✓	✓

Remote Controller



Enclosed in SLP-2FALM/SLP-2FALME



*optional



*optional



*optional



Type		Inverter Heat Pump					
Indoor Unit		SLZ-M25FA	SLZ-M35FA	SLZ-M50FA	SLZ-M60FA		
Outdoor Unit		SUZ-M25VA	SUZ-M35VA	SUZ-M50VA	SUZ-M60VA		
Refrigerant		R32*1					
Power Supply		Outdoor power supply					
		230 / Single / 50					
Cooling	Capacity	Rated	2.5	3.5	4.6	5.7	
		Min - Max	kW	1.4 - 3.2	0.7 - 3.9	1.0 - 5.2	1.5 - 6.3
	Total Input	Rated	kW	0.65	1.09	1.35	1.67
	Design Load		kW	2.5	3.5	4.6	5.7
	Annual Electricity Consumption*2		kWh/a	139	183	253	321
	SEER			6.3	6.7	6.3	6.2
		Energy Efficiency Class	A++				
Heating (Average Season)	Capacity	Rated	3.2	4.0	5.0	6.4	
		Min - Max	kW	1.3 - 4.2	1.0 - 5.0	1.3 - 5.5	1.6 - 7.3
	Total Input	Rated	kW	0.88	1.07	1.56	2.13
	Design Load		kW	2.2	2.6	3.6	4.6
	Declared Capacity	at reference design temperature	kW	2.0 (-10°C)	2.3 (-10°C)	3.2 (-10°C)	4.1 (-10°C)
		at bivalent temperature	kW	2.0 (-7°C)	2.3 (-7°C)	3.2 (-7°C)	4.1 (-7°C)
		at operation limit temperature	kW	2.0 (-10°C)	2.3 (-10°C)	3.2 (-10°C)	4.1 (-10°C)
	Back Up Heating Capacity		kW	0.2	0.3	0.4	0.5
Annual Electricity Consumption*2		kWh/a	716	843	1191	1559	
SCOP			4.3	4.3	4.2	4.1	
		Energy Efficiency Class	A+				
Operating Current (max)		A	7.0	8.7	13.7	15.1	
Indoor Unit	Input	Rated	kW	0.02	0.02	0.02	0.03
	Operating Current (max)		A	0.17	0.2	0.24	0.32
	Dimensions <Panel>	H x W x D	mm	245 - 570 - 570	245 - 570 - 570	245 - 570 - 570	245 - 570 - 570
	Weight <Panel>		kg	15	15	15	15
	Air Volume [Lo-Mid-Hi]		m³/min	6.0 - 6.5 - 7.0	6.5 - 7.5 - 8.5	6.5 - 8.0 - 9.5	7.0 - 9.0 - 11.5
	Sound Level (SPL) [Lo-Mid-Hi]		dB(A)	24 - 26 - 28	25 - 28 - 31	25 - 30 - 34	27 - 34 - 39
	Sound Level (PWL)		dB(A)	45	48	51	56
Outdoor Unit	Dimensions	H x W x D	mm	550 - 800 - 285	550 - 800 - 285	714 - 800 - 285	880 - 840 - 330
	Weight		kg	30	35	41	54
	Air Volume	Cooling	m³/min	36.3	34.3	45.8	50.1
		Heating	m³/min	34.6	32.7	43.7	50.1
	Sound Level (SPL)	Cooling	dB(A)	45	48	48	49
		Heating	dB(A)	46	48	49	51
	Sound Level (PWL)	Cooling	dB(A)	59	59	64	65
		Heating	dB(A)	59	59	64	65
	Operating Current (max)	A	6.8	8.5	13.5	14.8	
	Breaker Size	A	10	10	20	20	
Ext. Piping	Diameter	Liquid / Gas	mm	6.35 / 9.52	6.35 / 9.52	6.35 / 12.7	6.35 / 15.88
	Max. Length	Out-In	m	20	20	30	30
	Max. Height	Out-In	m	12	12	30	30
Guaranteed Operating Range [Outdoor]	Cooling	°C	-10~+46	-10~+46	-15~+46	-15~+46	
	Heating	°C	-10~+24	-10~+24	-10~+24	-10~+24	

*1 Refrigerant leakage contributes to climate change. Refrigerant with lower global warming potential (GWP) would contribute less to global warming than a refrigerant with higher GWP, if leaked to the atmosphere. This appliance contains a refrigerant fluid with a GWP equal to 1975. This means that if 1 kg of this refrigerant fluid would be leaked to the atmosphere, the impact on global warming would be 1975 times higher than 1 kg of CO₂, over a period of 100 years. Never try to interfere with the refrigerant circuit yourself or disassemble the product yourself and always ask a professional. The GWP of R410A is 2088 in the IPCC 4th Assessment Report.

*2 Energy consumption based on standard test results. Actual energy consumption will depend on how the appliance is used and where it is located.

SLZ-M SERIES



Indoor Unit

R32
R410A



SLZ-M15/25/35/50/60FA

Outdoor Unit



SUZ-KA25/35VA6



SUZ-KA50/60VA6

Panel

Panel	With Signal Receiver	With 3D i-see Sensor	With Wireless Remote Controller
SLP-2FA			
SLP-2FAL	✓		
SLP-2FAE		✓	
SLP-2FALE	✓	✓	
SLP-2FALM	✓		✓
SLP-2FALME	✓	✓	✓

Remote Controller



Enclosed in SLP-2FALM/SLP-2FALME



*optional



*optional



*optional

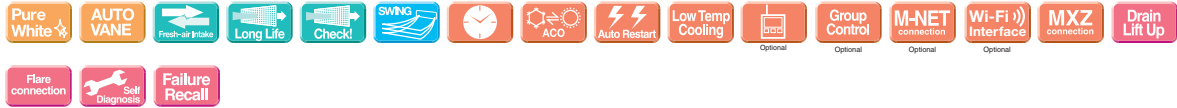

Type	Inverter Heat Pump							
Indoor Unit	SLZ-M15FA	SLZ-M25FA	SLZ-M35FA	SLZ-M50FA	SLZ-M60FA			
Outdoor Unit	for Multi connection	SUZ-KA25VA6	SUZ-KA35VA6	SUZ-KA50VA6	SUZ-KA60VA6			
Refrigerant	R410A*1							
Power Supply	Source	Outdoor power supply						
	Outdoor (V/Phase/Hz)	230 / Single / 50						
Cooling	Capacity	Rated	kW	–	2.6	3.5	4.6	5.6
		Min - Max	kW	–	1.5 - 3.2	1.4 - 3.9	2.3 - 5.2	2.3 - 6.5
	Total Input	Rated	kW	–	0.684	0.972	1.394	1.767
	Design Load		kW	–	2.6	3.5	4.6	5.6
	Annual Electricity Consumption*2		kWh/a	–	144	188	256	316
	SEER			–	6.3	6.5	6.3	6.2
		Energy Efficiency Class		–	A++	A++	A++	A++
Heating (Average Season)	Capacity	Rated	kW	–	3.2	4.0	5.0	6.4
		Min - Max	kW	–	1.3 - 4.2	1.7 - 5.0	1.7 - 6.0	2.5 - 7.4
	Total Input	Rated	kW	–	0.886	1.108	1.558	2.278
	Design Load		kW	–	2.2	2.6	3.6	4.6
	Declared Capacity	at reference design temperature	kW	–	2.0 (-10°C)	2.3 (-10°C)	3.2 (-10°C)	4.0 (-10°C)
		at bivalent temperature	kW	–	2.0 (-7°C)	2.3 (-7°C)	3.2 (-7°C)	4.0 (-7°C)
		at operation limit temperature	kW	–	2.0 (-10°C)	2.3 (-10°C)	3.2 (-10°C)	4.0 (-10°C)
	Back Up Heating Capacity		kW	–	0.2	0.3	0.4	0.4
Annual Electricity Consumption*2		kWh/a	–	716	845	1172	1572	
SCOP			–	4.3	4.3	4.3	4.1	
	Energy Efficiency Class		–	A+	A+	A+	A+	
Operating Current (max)		A	–	7.2	8.4	12.3	14.4	
Indoor Unit	Input	Rated	kW	0.02	0.02	0.02	0.03	0.04
	Operating Current (max)		A	0.17	0.20	0.24	0.32	0.43
	Dimensions <Panel>	H x W x D	mm	245-570-570 <10-625-625>	245-570-570 <10-625-625>	245-570-570 <10-625-625>	245-570-570 <10-625-625>	245-570-570 <10-625-625>
	Weight <Panel>		kg	15 <3>	15 <3>	15 <3>	15 <3>	15 <3>
	Air Volume [Lo-Mid-Hi]		m³/min	6.0 - 6.5 - 7.0	6.5 - 7.5 - 8.5	6.5 - 8.0 - 9.5	7.0 - 9.0 - 11.5	7.5 - 11.5 - 13.0
	Sound Level (SPL) [Lo-Mid-Hi]		dB(A)	24 - 26 - 28	25 - 28 - 31	25 - 30 - 34	27 - 34 - 39	32 - 40 - 43
	Sound Level (PWL)		dB(A)	45	48	51	56	60
Outdoor Unit	Dimensions	H x W x D	mm	–	550 - 800 - 285	550 - 800 - 285	880 - 840 - 330	880 - 840 - 330
	Weight		kg	–	30	35	54	50
	Air Volume	Cooling	m³/min	–	32.6	36.3	44.6	40.9
		Heating	m³/min	–	34.7	34.8	44.6	49.2
	Sound Level (SPL)	Cooling	dB(A)	–	47	49	52	55
		Heating	dB(A)	–	48	50	52	55
	Sound Level (PWL)	Cooling	dB(A)	–	58	62	65	65
		Heating	dB(A)	–	58	62	65	65
	Operating Current (max)		A	–	7.0	8.2	12.0	14.0
	Breaker Size		A	–	10	10	20	20
Ext. Piping	Diameter	Liquid / Gas	mm	–	6.35 / 9.52	6.35 / 9.52	6.35 / 12.7	6.35 / 15.88
	Max. Length	Out-In	m	–	20	20	30	30
	Max. Height	Out-In	m	–	12	12	30	30
Guaranteed Operating Range [Outdoor]	Cooling		°C	–	-10 ~ +46	-10 ~ +46	-15 ~ +46	-15 ~ +46
	Heating		°C	–	-10 ~ -24	-10 ~ -24	-10 ~ +24	-10 ~ +24

*1 Refrigerant leakage contributes to climate change. Refrigerant with lower global warming potential (GWP) would contribute less to global warming than a refrigerant with higher GWP, if leaked to the atmosphere. This appliance contains a refrigerant fluid with a GWP equal to 1975. This means that if 1 kg of this refrigerant fluid would be leaked to the atmosphere, the impact on global warming would be 1975 times higher than 1 kg of CO₂, over a period of 100 years. Never try to interfere with the refrigerant circuit yourself or disassemble the product yourself and always ask a professional. The GWP of R410A is 2088 in the IPCC 4th Assessment Report.

*2 Energy consumption based on standard test results. Actual energy consumption will depend on how the appliance is used and where it is located.

SEZ SERIES

R32
R410A

SEZ-M25-71DA(L)

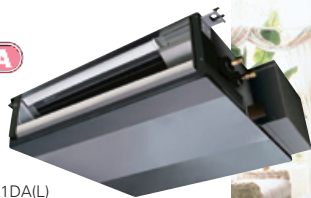

This concealed ceiling-mounted indoor unit series is compact, and fits easily into rooms with lowered ceilings. Highly reliable energy-saving performance makes it a best match choice for concealed unit installations.

Compact Ceiling-concealed Units

Only the intake-air grille and outlet vents are visible when using this ceiling-concealed indoor unit. The rest of the unit is conveniently hidden in the ceiling cavity, essentially leaving the ceiling and walls free of bulky looking devices and maintaining a high-class interior décor. The compact units require minimal space and can be installed in buildings with lowered ceilings, where exposed units were the rule in the past.

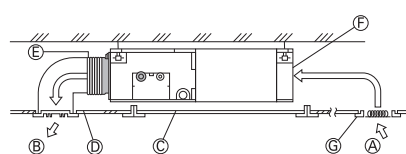

- Ⓐ Air inlet
- Ⓑ Air outlet
- Ⓒ Access door
- Ⓓ Ceiling surface
- Ⓔ Canvas duct
- Ⓕ Air filter
- Ⓖ Inlet grille

Selection of Fan Speeds and Static Pressure Levels

DC fan motor settings have been increased to accommodate more application needs. Three fan speed settings (Low, Medium and High) and four static pressure levels (5, 15, 35 and 50Pa) are now available.

SEZ-M25-71DA(L)

5/15/35/50 Pa

Four Levels Available for All Models

We've lowered the minimum static pressure level, resulting in less room noise when the optimum static pressure is selected.

SPL (Low Fan Mode)	
SEZ-M	
External Static Pressure	15 Pa
35	23dB
50	30dB
60	30dB
71	30dB

Drain Pump (Optional)

The PAC-KE07DM-E drain pump is now available as an option.

With the pump, a drain hose length of up to 550mm can be used, adding to increased installation possibilities.

SEZ-M SERIES



Indoor Unit

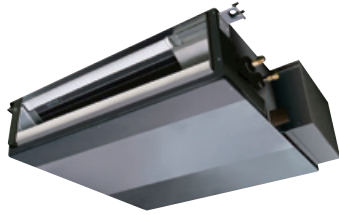

SEZ-M25/35/50/60/71DA (Requires Wired Remote Controller)
SEZ-M25/35/50/60/71DAL (Wireless Remote Controller is enclosed)

Outdoor Unit



Remote Controller

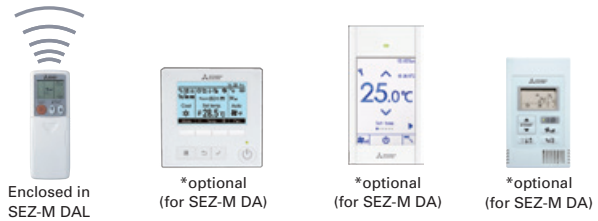

Type		Inverter Heat Pump							
Indoor Unit		SEZ-M25DA	SEZ-M35DA	SEZ-M50DA	SEZ-M60DA	SEZ-M71DA			
Outdoor Unit		SUZ-M25VA	SUZ-M35VA	SUZ-M50VA	SUZ-M60VA	SUZ-M71VA			
Refrigerant		R32*1							
Power Supply		Outdoor power supply							
Source		230 / Single / 50							
Outdoor (V/Phase/Hz)		230 / Single / 50							
Cooling	Capacity	Rated	kW	2.5	3.5	5.0	6.1	7.1	
		Min - Max	kW	1.4 - 3.2	0.7 - 3.9	1.1 - 5.6	1.6 - 6.3	2.2 - 8.1	
	Total Input	Rated	kW	0.71	1.00	1.54	1.84	2.15	
	Design Load		kW	2.5	3.5	5.0	6.1	7.1	
	Annual Electricity Consumption*2		kWh/a	165	207	290	386	452	
	SEER*3			5.3	5.9	6.0	5.5	5.5	
		Energy Efficiency Class		A	A+	A+	A	A	
Heating (Average Season)	Capacity	Rated	kW	2.9	4.2	6.0	7.4	8.0	
		Min - Max	kW	1.3 - 4.2	1.1 - 5.0	1.5 - 7.2	1.6 - 8.0	2.0 - 10.2	
	Total Input	Rated	kW	0.80	1.07	1.61	2.04	2.28	
	Design Load		kW	2.2	2.6	4.3	4.6	5.8	
	Declared Capacity	at reference design temperature	kW	2.0 (-10°C)	2.3 (-10°C)	3.8 (-10°C)	4.1 (-10°C)	5.2 (-10°C)	
		at bivalent temperature	kW	2.0 (-7°C)	2.3 (-7°C)	3.8 (-7°C)	4.1 (-7°C)	5.2 (-7°C)	
		at operation limit temperature	kW	2.0 (-10°C)	2.3 (-10°C)	3.8 (-10°C)	4.1 (-10°C)	5.2 (-10°C)	
Back Up Heating Capacity		kW	0.2	0.3	0.5	0.5	0.6		
Annual Electricity Consumption*2		kWh/a	807	884	1499	1525	2072		
SCOP*3			3.8	4.1	4.0	4.2	3.9		
	Energy Efficiency Class		A	A+	A+	A+	A		
Operating Current (max)		A	7.2	9.0	14.2	15.5	15.7		
Indoor Unit	Input	Rated	kW	0.04	0.05	0.07	0.07	0.10	
	Operating Current (max)		A	0.40	0.50	0.70	0.70	0.90	
	Dimensions <Panel>	H x W x D	mm	200 - 790 - 700	200 - 990 - 700	200 - 990 - 700	200 - 1190 - 700	200 - 1190 - 700	
	Weight <Panel>		kg	18	21	23	27	27	
	Air Volume [Lo-Mid-Hi]		m³/min	6 - 7 - 9	7 - 9 - 11	10 - 13 - 15	12 - 15 - 18	12 - 16 - 20	
	External Static Pressure		Pa	5 / 15 / 35 / 50	5 / 15 / 35 / 50	5 / 15 / 35 / 50	5 / 15 / 35 / 50	5 / 15 / 35 / 50	
	Sound Level (SPL) [Lo-Mid-Hi]		dB(A)	22 - 25 - 29	23 - 28 - 33	29 - 33 - 36	29 - 33 - 37	29 - 34 - 39	
	Sound Level (PWL)		dB(A)	50	53	57	58	60	
	Outdoor Unit	Dimensions	H x W x D	mm	550 - 800 - 285	550 - 800 - 285	714 - 800 - 285	880 - 840 - 330	880 - 840 - 330
		Weight		kg	30	35	41	54	55
Air Volume		Cooling	m³/min	36.3	34.3	45.8	50.1	50.1	
		Heating	m³/min	34.6	32.7	43.7	50.1	50.1	
Sound Level (SPL)		Cooling	dB(A)	45	48	48	49	49	
		Heating	dB(A)	46	48	49	51	51	
Sound Level (PWL)		Cooling	dB(A)	59	59	64	65	66	
Operating Current (max)			A	6.8	8.5	13.5	14.8	14.8	
Breaker Size			A	10	10	20	20	20	
Ext. Piping		Diameter	Liquid / Gas	mm	6.35 / 9.52	6.35 / 9.52	6.35 / 12.7	6.35 / 15.88	9.52 / 15.88
	Max. Length	Out-In	m	20	20	30	30	30	
	Max. Height	Out-In	m	12	12	30	30	30	
Guaranteed Operating Range [Outdoor]	Cooling	°C	-10 ~ +46	-10 ~ +46	-15 ~ +46	-15 ~ +46	-15 ~ +46		
	Heating	°C	-10 ~ +24	-10 ~ +24	-10 ~ +24	-10 ~ +24	-10 ~ +24		

*1 Refrigerant leakage contributes to climate change. Refrigerant with lower global warming potential (GWP) would contribute less to global warming than a refrigerant with higher GWP, if leaked to the atmosphere. This appliance contains a refrigerant fluid with a GWP equal to 1975. This means that if 1 kg of this refrigerant fluid would be leaked to the atmosphere, the impact on global warming would be 1975 times higher than 1 kg of CO₂, over a period of 100 years. Never try to interfere with the refrigerant circuit yourself or disassemble the product yourself and always ask a professional. The GWP of R410A is 2088 in the IPCC 4th Assessment Report.

*2 Energy consumption based on standard test results. Actual energy consumption will depend on how the appliance is used and where it is located.

*3 SEER/SCOP are measured at ESP 35Pa.

SEZ-M SERIES



Indoor Unit

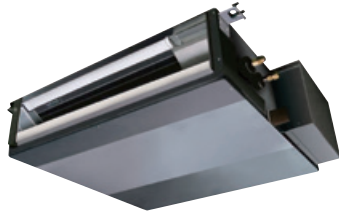

SEZ-M25/35/50/60/71DA (Requires Wired Remote Controller)
SEZ-M25/35/50/60/71DAL (Wireless Remote Controller is enclosed)

Outdoor Unit



SUZ-KA25/35VA6



SUZ-KA50/60/71VA6

Remote Controller



Enclosed in SEZ-M DAL



*optional (for SEZ-M DA)



*optional (for SEZ-M DA)



*optional (for SEZ-M DA)



Type		Inverter Heat Pump						
Indoor Unit		SEZ-M25DA(L)	SEZ-M35DA(L)	SEZ-M50DA(L)	SEZ-M60DA(L)	SEZ-M71DA(L)		
Outdoor Unit		SUZ-KA25VA6	SUZ-KA35VA6	SUZ-KA50VA6	SUZ-KA60VA6	SUZ-KA71VA6		
Refrigerant		R410A* ¹						
Power Supply		Outdoor power supply						
		230 / Single / 50						
Cooling	Capacity	Rated	kW	2.5	3.5	5.1	5.6	7.1
		Min - Max	kW	1.5 - 3.2	1.4 - 3.9	2.3 - 5.6	2.3 - 6.3	2.8 - 8.3
	Total Input	Rated	kW	0.730	1.010	1.580	1.740	2.210
	Design Load		kW	2.5	3.5	5.1	5.6	7.1
	Annual Electricity Consumption* ²		kWh/a	162	210	300	356	458
	SEER* ³			5.3	5.7	5.8	5.3	5.3
		Energy Efficiency Class		A	A+	A+	A	A
Heating (Average Season)	Capacity	Rated	kW	2.9	4.2	6.4	7.4	8.1
		Min - Max	kW	1.3 - 4.5	1.7 - 5.0	1.7 - 7.2	2.5 - 8.0	2.6 - 10.4
	Total Input	Rated	kW	0.803	1.130	1.800	2.200	2.268
	Design Load		kW	2.2	2.8	4.6	5.5	6.0
	Declared Capacity	at reference design temperature	kW	1.9 (-10°C)	2.5 (-10°C)	4.1 (-10°C)	4.5 (-10°C)	5.3 (-10°C)
		at bivalent temperature	kW	1.9 (-7°C)	2.5 (-7°C)	4.1 (-7°C)	4.8 (-7°C)	5.3 (-7°C)
		at operation limit temperature	kW	1.9 (-10°C)	2.5 (-10°C)	4.1 (-10°C)	4.5 (-10°C)	5.3 (-10°C)
	Back Up Heating Capacity		kW	0.3	0.3	0.5	1.0	0.7
Annual Electricity Consumption* ²		kWh/a	808	979	1653	1878	2202	
SCOP* ³			3.8	4.0	3.9	4.1	3.8	
		Energy Efficiency Class		A	A+	A	A+	A
Operating Current (max)			A	7.4	8.7	12.7	14.7	17.0
Indoor Unit	Input	Rated	kW	0.040	0.050	0.070	0.070	0.100
			A	0.4	0.5	0.7	0.7	0.9
	Operating Current (max)		A	0.4	0.5	0.7	0.7	0.9
	Dimensions <Panel>	H x W x D	mm	200 - 790 - 700	200 - 990 - 700	200 - 990 - 700	200 - 1190 - 700	200 - 1190 - 700
	Weight <Panel>		kg	18	21	23	27	27
	Air Volume [Lo-Mid-Hi]		m ³ /min	6 - 7 - 9	7 - 9 - 11	10 - 13 - 15	12 - 15 - 18	12 - 16 - 20
	External Static Pressure		Pa	5 / 15 / 35 / 50	5 / 15 / 35 / 50	5 / 15 / 35 / 50	5 / 15 / 35 / 50	5 / 15 / 35 / 50
	Sound Level (SPL) [Lo-Mid-Hi]		dB(A)	22 - 25 - 29	23 - 28 - 33	29 - 33 - 36	29 - 33 - 37	29 - 34 - 39
Sound Level (PWL)		dB(A)	50	53	57	58	60	
Outdoor Unit	Dimensions	H x W x D	mm	550 - 800 - 285	550 - 800 - 285	880 - 840 - 330	880 - 840 - 330	880 - 840 - 330
			kg	30	35	54	50	53
	Air Volume	Cooling	m ³ /min	32.6	36.3	44.6	40.9	50.1
		Heating	m ³ /min	34.7	34.8	44.6	49.2	48.2
	Sound Level (SPL)	Cooling	dB(A)	47	49	52	55	55
		Heating	dB(A)	48	50	52	55	55
	Sound Level (PWL)	Cooling	dB(A)	58	62	65	65	69
	Operating Current (max)			A	7.0	8.0	12.0	14.0
Breaker Size			A	10	10	20	20	20
Ext. Piping	Diameter	Liquid / Gas	mm	6.35 / 9.52	6.35 / 9.52	6.35 / 12.7	6.35 / 15.88	9.52 / 15.88
	Max. Length	Out-In	m	20	20	30	30	30
	Max. Height	Out-In	m	12	12	30	30	30
Guaranteed Operating Range [Outdoor]	Cooling	°C	-10 ~ +46	-10 ~ +46	-15 ~ +46	-15 ~ +46	-15 ~ +46	
	Heating	°C	-10 ~ +24	-10 ~ +24	-10 ~ +24	-10 ~ +24	-10 ~ +24	

*1 Refrigerant leakage contributes to climate change. Refrigerant with lower global warming potential (GWP) would contribute less to global warming than a refrigerant with higher GWP, if leaked to the atmosphere. This appliance contains a refrigerant fluid with a GWP equal to 1975. This means that if 1 kg of this refrigerant fluid would be leaked to the atmosphere, the impact on global warming would be 1975 times higher than 1 kg of CO₂, over a period of 100 years. Never try to interfere with the refrigerant circuit yourself or disassemble the product yourself and always ask a professional. The GWP of R410A is 2088 in the IPCC 4th Assessment Report.

*2 Energy consumption based on standard test results. Actual energy consumption will depend on how the appliance is used and where it is located.

*3 SEER/SCOP are measured at ESP 35Pa.











P

SERIES

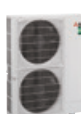















SELECTION

Line-up includes a selection of eight indoor units and four series of outdoor units. Easily construct a system that best matches room air conditioning needs.

R32 INDOOR UNIT		R32 OUTDOOR UNIT	
 4-way ceiling-cassette PLA-ZM EA PLA-M EA	 Wall-mounted PKA-M HA (L) PKA-M KA (L)	Power Inverter  PUZ-ZM35/50  PUZ-ZM60/71  PUZ-ZM100/125/140	Standard Inverter  SUZ-M35*  SUZ-M50*  SUZ-M60/71*  PUZ-M100/125/140
 Ceiling-concealed PEAD-M			
 Ceiling-suspended PCA-M			

* Some indoor units cannot be used with this unit.

R410A INDOOR UNIT		R410A OUTDOOR UNIT	
 4-way ceiling-cassette PLA-ZM EA PLA-M EA	 Wall-mounted PKA-M HA (L) PKA-M KA (L)	Power Inverter  PUHZ-ZRP35/50  PUHZ-ZRP60/71  PUHZ-ZRP100/125/140/ 200/250	Standard Inverter  SUZ-KA35*  SUZ-KA50/60/71*  PUHZ-P100/125/140  PUHZ-P200/250
 Ceiling-concealed PEAD-M	 Floor-standing PSA-KA		
 Ceiling-suspended PCA-M	 Ceiling-concealed PEA-WKA		
 Professional Kitchen PCA-HAQ			

To confirm compatibility with the MXZ Series, refer to the MXZ Series page.

* Some indoor units cannot be used with this unit.

SELECT COMBINATION

Choose the installation pattern for the indoor units. (In the case of a multi-system, distribution piping is necessary, so please select the necessary piping as well.)

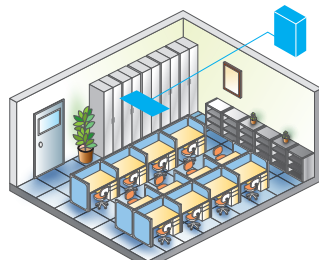
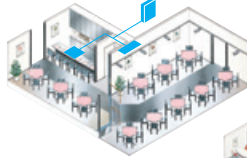
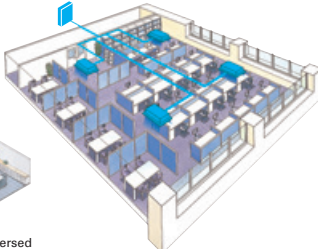
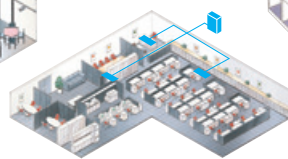
<p>Single System</p> 	<p>Simultaneous Multi-System</p> <p>Twin Allows simultaneous operation of two indoor units on one floor.</p> 	<p>Quadruple Realises the optimum temperature distribution even in a large space.</p> 
	<p>Triple Can cover a large-scale space or dispersed installation on the same floor.</p> 	

Connectable Combinations for Inverter Units (PUZ-ZM / PUZ-M / PUHZ-ZRP / PUHZ-P)

Outdoor Unit Capacity	Indoor Unit Capacity		
	Twin 50 : 50	Triple 33 : 33 : 33	Quadruple 25 : 25 : 25 : 25
71	35 × 2	—	—
100	50 × 2	—	—
125	60 × 2	—	—
140	71 × 2	50 × 3	—
200	100 × 2	60 × 3	50 × 4
250	125 × 2	71 × 3	60 × 4
Distribution Pipe	MSDD-50TR-E MSDD-50WR-E MSDD-50TR2-E2	MSDT-111R-E MSDT-111R2-E2	MSDF-1111R-E

Notes: 1) Indoor unit combinations with floor-standing (PS) units and other types are impossible.
2) The distribution pipe listed is required for simultaneous multi-systems.

Power Inverter SERIES

Our Eco-conscious Power Inverter Series is designed to achieve industry-leading seasonal energy-efficiency through use of New R32 refrigerant and advanced technologies.



Industry-leading energy efficiency

Introduction of new R32 refrigerant realises improved cooling efficiency. Rating of more than 7.0 achieved for all capacity range.

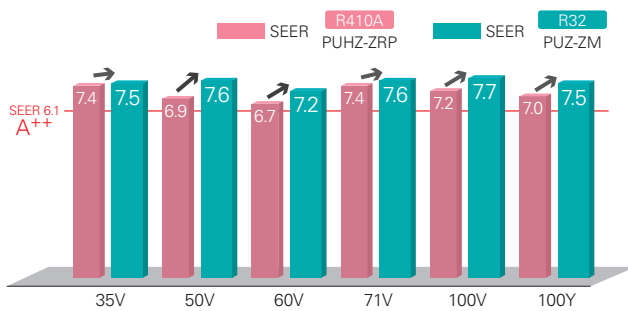

Introduction of new R32 refrigerant reduces energy consumption and realises energy savings.

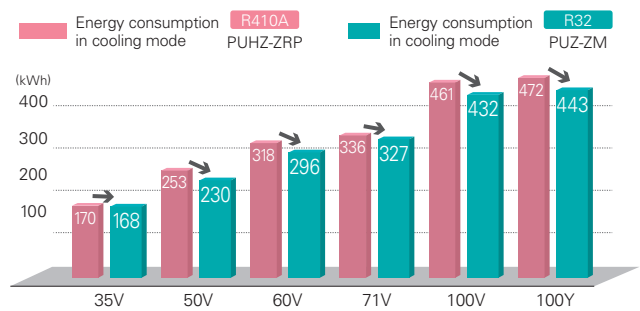

Longer piping (60/71/100/125/140)

Longer piping length realised for 60, 71, 100, 125 and 140 classes, widely increasing installation flexibility.

	Piping Length	
	R410A PUAZ-ZRP	R32 PUZ-ZM
35/50	50m	50m
60/71	50m	55m
100/125/140	75m	100m

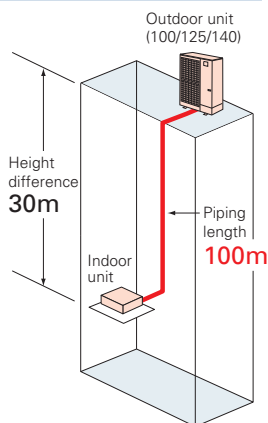

Rated heating capacity maintained down to -3°C

Rated heating capacity maintained even when the outside temperature is down to -3°C. Stay warm even at times of cold weather.

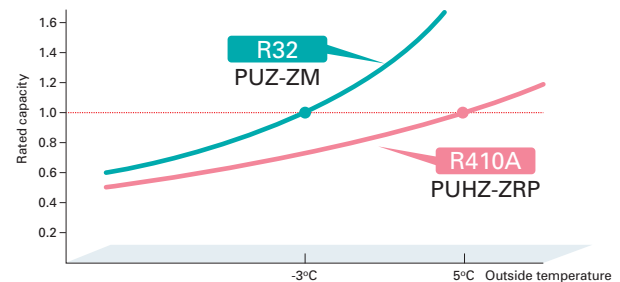

30Pa external static pressure *Option (requires PAC-SJ71FM-E)

An external static pressure of 30Pa enables the outdoor unit to be installed on balconies in high-rise building or spaces near louvers.

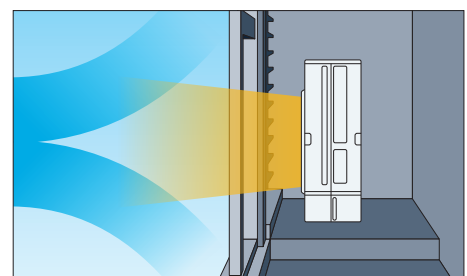
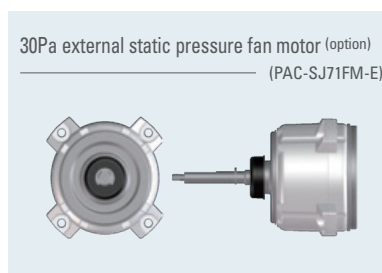

*Rated noise level will be higher when equipped with this option.

Standard Inverter SERIES

Our Standard Series become light and compact with greater energy-saving performance.

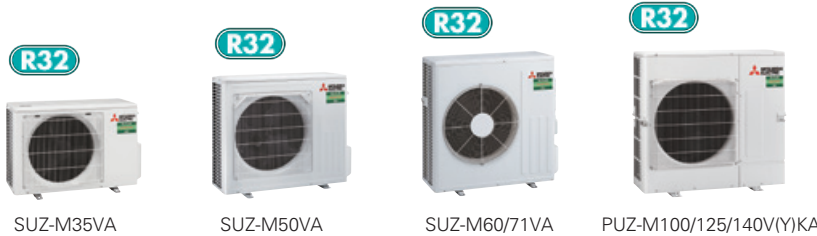

Improved energy efficiency

Introduction of new R32 refrigerant realises improved cooling efficiency. Rating of more than 6.6 achieved for all capacity range.

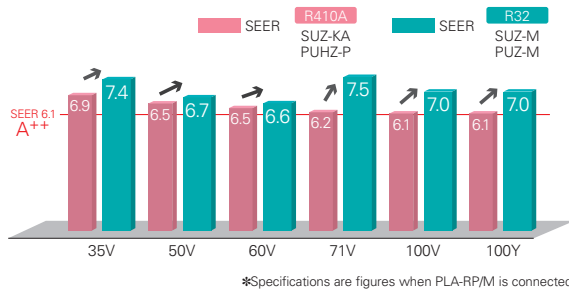

Longer piping (100/125/140)

Longer piping length realised for 100, 125 and 140 classes, widely increasing installation flexibility.

	Max. Piping Length	
	R410A SUZ-KA PUIH-Z-P	R32 SUZ-M PUZ-M
25/35	20m	20m
50/60/71	30m	30m
100	50m	55m
125/140	50m	65m

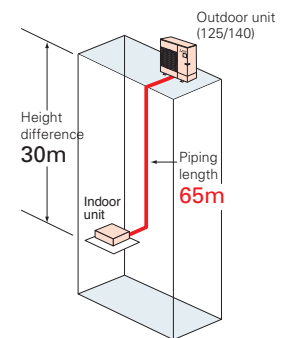

Expansion of connectable indoor unit

MLZ Series are newly connectable with Standard Inverter Series. The diverse selection enables the best solution for both customer and location.

		PLA Series	PEAD Series	PKA Series	PCA-KA Series	SLZ Series	SEZ Series	MLZ Series
R32	SUZ-M	✓	✓		✓	✓	✓	✓
	PUZ-M	✓	✓	✓	✓			
R410A	SUZ-KA	✓	✓		✓	✓	✓	
	PUIH-Z-P	✓	✓	✓	✓			

Indoor Unit Combination	Outdoor Unit Capacity													
	Single							Twin						Triple
	25	35	50	60	71	100	125	140	71	100	125	140	140	
PLA-M**EA		35x1	50x1	60x1	71x1	100x1	125x1	140x1		50x2	60x2	71x2	50x3	
PEAD-M**JA(L)		35x1	50x1	60x1	71x1	100x1	125x1	140x1		50x2	60x2	71x2	50x3	
PKA-M**HA(L)/KA(L)						100x1	125x1	140x1		50x2	60x2	71x2	50x3	
PCA-M**KA		35x1	50x1	60x1	71x1	100x1	125x1	140x1		50x2	60x2	71x2	50x3	
SLZ-M**FA	25x1	35x1	50x1	60x1										
SEZ-M**DA(L)	25x1	35x1	50x1	60x1	71x1									
MLZ-KP**VF	25x1	35x1	50x1											

Light weight and compact size

Compact design fits into narrow outdoor unit space of condominiums and offices. Light weight design facilitates easy installation.

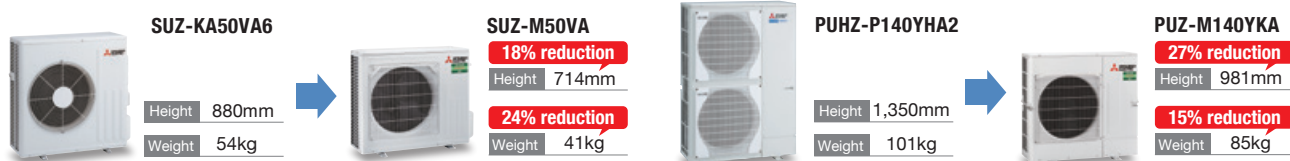

Unobstructive, compact, and easy to hide from view

Conventional outdoor units may spoil the view. Due to its compact size, the new model can be installed in locations that previous model is not suitable.

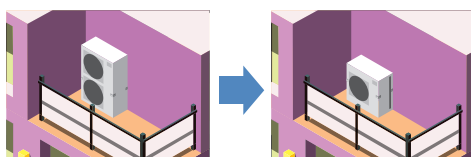

Easy transportation and installation

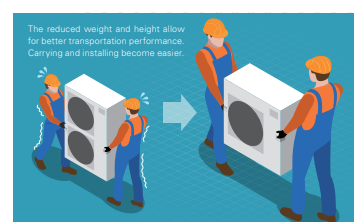

Transport efficiency improves thanks to its low height. The unit can even be transported by minivan.

PLA SERIES

R32
R410A
PLA-ZM35/50/60/71/100/125/140EA



R32
R410A
PLA-M35/50/60/71/100/125/140EA



A complete line-up including deluxe units that offer added energy savings. The incorporation of wide air-outlet and the "3D i-see Sensor" enhances airflow distribution control, achieving an enhanced level of comfort throughout the room. The synergy of higher energy efficiency and more comfortable room environment results in the utmost user satisfaction.

Deluxe 4-way Cassette Line-up

For users seeking even further energy savings, Mitsubishi Electric now offers deluxe units (PLA-ZM) to complete the line-up of models in this series, from 35-140. Compared to the standard models (PLA-RP), deluxe models provide additional energy savings, contributing to a significant reduction in electricity costs.

Indoor/Outdoor Unit Combinations

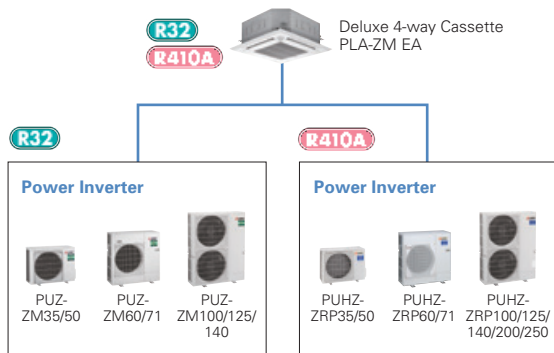

Line-up

Series	Model	35	50	60	71	100	125	140
R32 R410A	Deluxe 4-way Cassette (PLA-ZM)	●	●	●	●	●	●	●
R32 R410A	Standard 4-way Cassette (PLA-M)	●	●	●	●	●	●	●

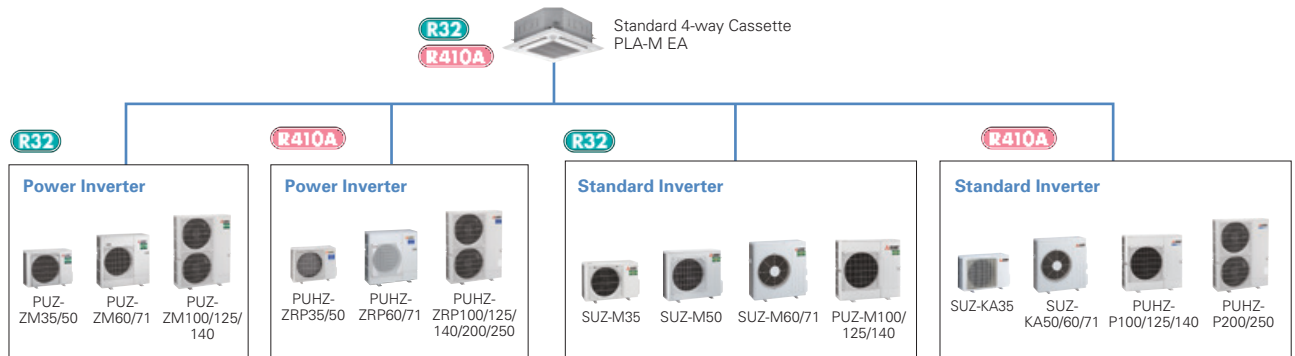

Industry-leading energy efficiency

Introduction of new R32 refrigerant realises improved cooling efficiency. Rating of more than 7.0 achieved for all capacity range.

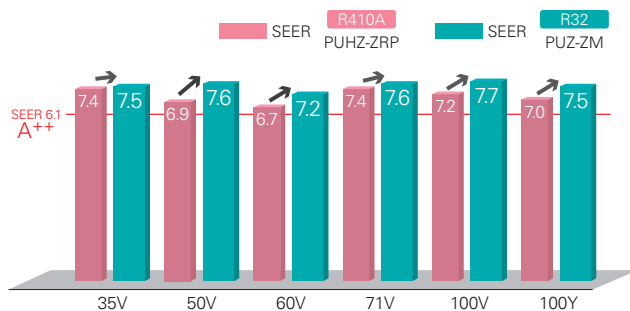

Introduction of new R32 refrigerant reduces energy consumption and realises energy savings.

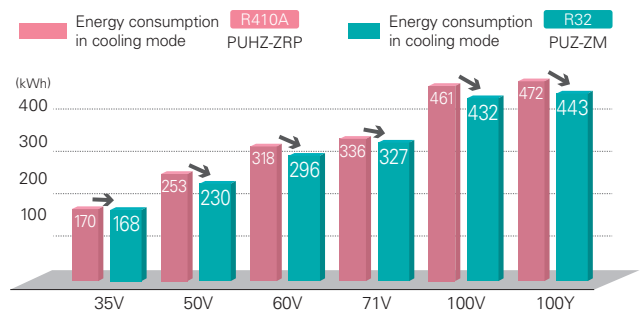

*Specifications reported are figures when PLA-ZM**EA is connected.

Horizontal Airflow

The new airflow control removes that uncomfortable drafty feeling with the introduction of a horizontal airflow that spreads across the ceiling. The ideal airflow for offices and restaurants.

[Horizontal airflow]
 Model name: PLA-ZM140EA
 Ceiling height: 3.2m
 Mode: Cooling

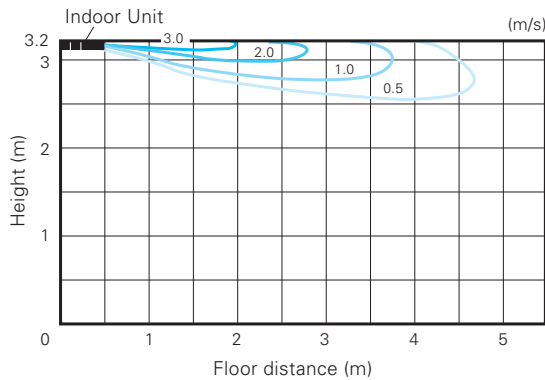

Automatic Grille Lowering Function (PLP-6EAJ)

An automatic grille lowering function is available for easy filter maintenance. Special wired and wireless remote controllers can be used to lower the intake grille for maintenance.



Grille Elevation Remote Controller
 (comes with the automatic elevation panel)



Wired Remote Controller



Wireless Remote Controller

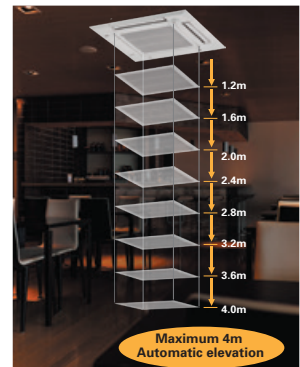

Easy Installation

Electrical box wiring

After reviewing the power supply terminal position in the electrical box, the structure was redesigned to improve connectivity. This has made previously complex wiring work easier.

■ Previous model (B Series)



■ New model (E Series)



Increased space for plumbing work

The top and bottom positions of the liquid and gas pipes have been reversed to allow the gas pipe work, which requires more effort, to be completed first. Further, through structural innovations related to the space around the pipes, the area where the spanner can be moved has been increased, thus improving liquid pipe work and enabling it to be completed smoothly.

■ Previous model (B Series)



■ New model (E Series)



Temporary hanging hook

The structure of the panel has been revised and is now equipped with a temporary hanging hook. This has improved work efficiency during panel installation.



No need to remove screws

Installation is possible without removing the screws for the corner panel and the control box, simply loosen them. This lowers the risk of losing screws.

■ Corner panel



■ Control box cover



Lightweight decorative panel

After reviewing the structure and materials, weight has been reduced approximately 20% compared to the previous model, reducing the burden of installation.



Detects number of people

3D i-see Sensor detects the number of people in the room and sets the air-conditioning power accordingly. This makes automatic power-saving operation possible in places where the number of people entering and exiting is large. Additionally, when the area is continuously unoccupied, the system switches to a more enhanced power-saving mode. Depending on the setting, it will save additional capacity or stop operation altogether.

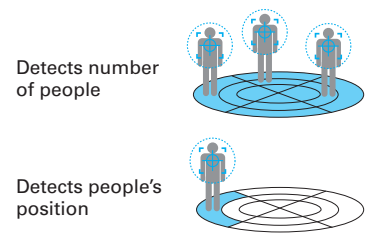
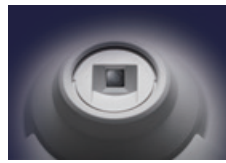

Detects people's position

Once the position of a person is detected, the duct angle of the vane is automatically adjusted in that direction. Each vane can be independently set to "block wind" or "not block wind" according to taste.

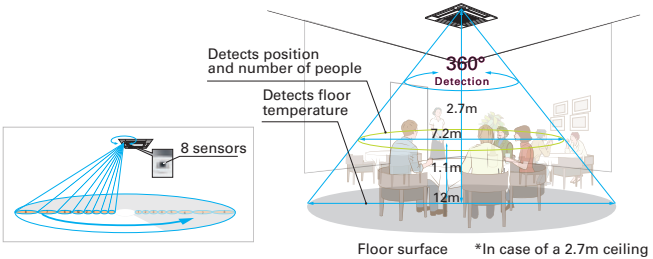

Detects number of people

Room occupancy energy-saving mode

The 3D i-see Sensor detects the number of people in the room. It then calculates the occupancy rate based on the maximum number of people in the room up to that point in time in order to save air-conditioning power. When the occupancy rate is approximately 30%, air-conditioning power equivalent to 1°C during both cooling and heating operation is saved. The temperature is controlled according to the number of people.

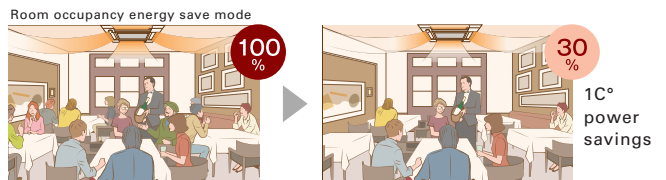

No occupancy energy-saving mode

When 3D i-see Sensor detects that no one is in the room, the system is switched to a pre-set power-saving mode. If the room remains unoccupied for more than 60min, air-conditioning power equivalent to 2°C during both cooling and heating operation is saved. This contributes to preventing waste in terms of heating and cooling.

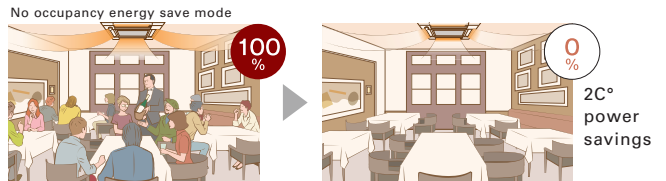

No occupancy Auto-OFF mode*

When the room remains unoccupied for a pre-set period of time, the air conditioner turns off automatically, thereby providing even greater power savings. The time until operation is stopped can be set in intervals of 10min, ranging from 60 to 180 min.

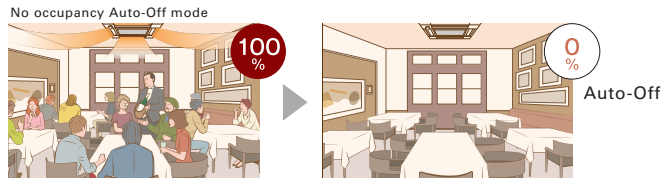

* When MA Remote Controller is used to control multiple refrigerant systems, "No occupancy Auto-OFF mode" cannot be used.

*PAR-40MAA is required for each setting

Detects people's position

Direct/Indirect settings*

Some people do not like the feel of wind, some want to be warm from head to toe. People's likes and dislikes vary. With the 3D i-see Sensor, it is possible to choose to block or not block to the wind for each vane.

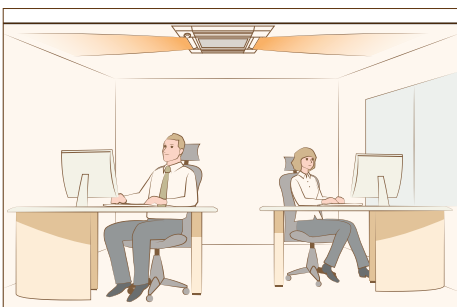

*PAR-40MAA or PAR-SL100A-E is required for each setting.

Seasonal airflow*

<When cooling>

Saves energy while keeping a comfortable effective temperature by automatically switching between ventilation and cooling. When a pre-set temperature is reached, the air conditioning unit switches to swing fan operation to maintain the effective temperature. This clever function contributes to keeping a comfortable coolness.

<When heating>

The air conditioning unit automatically switches between circulator and heating. Wasted heat that accumulates near the ceiling is reused via circulation. When a pre-set temperature is reached the air conditioner switches from heating to circulator and blows air in the horizontal direction. It pushes down the warm air that has gathered near the ceiling to people's height, thereby providing smart heating.

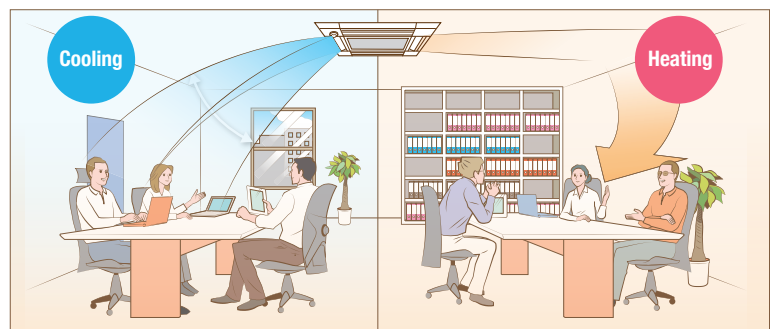

*PAR-40MAA is required for each setting.

SERIES SELECTION

Power Inverter Series



Indoor Unit

R32
R410A



Panel PLA-ZM35/50/60/71/100/125/140EA

Panel	With Signal Receiver	With 3D i-see Sensor	With Wireless Remote Controller	With Auto Elevation
PLP-6EA				
PLP-6EAL	✓			
PLP-6EAE		✓		
PLP-6EALAE	✓	✓		
PLP-6EAJ	✓			✓
PLP-6EAJE	✓	✓		✓
PLP-6EALM	✓		✓	
PLP-6EALME	✓	✓	✓	

Outdoor Unit

R32

For Single



PUZ-ZM60/71

IO

R32

For Multi (Twin/Triple)



PUZ-ZM71

IO

Remote Controller



Optional



Optional



Optional



Included in PLP-6EALM/PLP-6EALME

PLA-ZM EA Indoor Unit Combinations Indoor unit combinations shown below are possible.

Indoor Unit Combination	Outdoor Unit Capacity																			
	For Single								For Twin					For Triple			For Quadruple			
	35	50	60	71	100	125	140	200	250	71	100	125	140	200	250	140	200	250	200	250
Power Inverter (PUZ-ZM)	35x1	50x1	60x1	71x1	100x1	125x1	140x1	-	-	35x2	50x2	60x2	71x2	-	-	50x3	-	-	-	-
Distribution Pipe	-	-	-	-	-	-	-	-	-	MSDD-50TR2-E					-	MSDT-111R2-E			-	

SERIES SELECTION

Standard Inverter Series



Indoor Unit

R32
R410A



Panel PLA-M35/50/60/71/100/125/140EA

Panel	With Signal Receiver	With 3D i-see Sensor	With Wireless Remote Controller	With Auto Elevation
PLP-6EA				
PLP-6EAL	✓			
PLP-6EAE		✓		
PLP-6EALAE	✓	✓		
PLP-6EAJ	✓			✓
PLP-6EAJE	✓	✓		✓
PLP-6EALM	✓		✓	
PLP-6EALME	✓	✓	✓	

Outdoor Unit

R32

For Single



SUZ-M35

SUZ-M50

SUZ-M60/71

PUZ-M100/125/140

R32

For Multi (Twin/Triple)



PUZ-M100/125/140

Remote Controller



Optional



Optional



Optional



Included in PLP-6EALM/PLP-6EALME

PLA-M EA Indoor Unit Combinations Indoor unit combinations shown below are possible.

Indoor Unit Combination	Outdoor Unit Capacity																			
	For Single								For Twin					For Triple			For Quadruple			
	35	50	60	71	100	125	140	200	250	71	100	125	140	200	250	140	200	250	200	250
Power Inverter (SUZ-M & PUZ-M)	35x1	50x1	60x1	71x1	100x1	125x1	140x1	-	-	50x2	60x2	71x2	-	-	50x3	-	-	-	-	
Distribution Pipe	-	-	-	-	-	-	-	-	-	MSDD-50TR2-E					-	MSDT-111R2-E			-	

PLA-M SERIES

POWER INVERTER



Type		Inverter Heat Pump												
Indoor Unit		PLA-M35EA	PLA-M50EA	PLA-M60EA	PLA-M71EA	PLA-M100EA		PLA-M125EA		PLA-M140EA				
Outdoor Unit		PUZ-ZM35VKA	PUZ-ZM50VKA	PUZ-ZM60VHA	PUZ-ZM71VHA	PUZ-ZM100VKA	PUZ-ZM100YKA	PUZ-ZM125VKA	PUZ-ZM125YKA	PUZ-ZM140VKA	PUZ-ZM140YKA			
Refrigerant		R32*1												
Power Supply		Outdoor power supply												
Outdoor (V/Phase/Hz)		VKA · VHA:230 / Single / 50, YKA:400 / Three / 50												
Cooling	Capacity	Rated	kW	3.6	5.0	6.1	7.1	9.5	9.5	12.5	12.5	13.4	13.4	
		Min - Max	kW	1.6 - 4.5	2.3 - 5.6	2.7 - 6.5	3.3 - 8.1	4.9 - 11.4	4.9 - 11.4	5.5 - 14.0	5.5 - 14.0	6.2 - 15.0	6.2 - 15.0	
	Total Input	Rated	kW	0.751	1.175	1.523	1.716	2.084	2.084	3.399	3.399	3.746	3.746	
	EER			4.79	4.25	4.00	4.14	4.56	4.56	3.68	3.68	3.58	3.58	
		EEL Rank		-	-	-	-	-	-	-	-	-	-	
		Design Load	kW	3.6	5.0	6.1	7.1	9.5	9.5	-	-	-	-	
		Annual Electricity Consumption*2	kWh/a	172	234	299	332	435	446	-	-	-	-	
		SEER		7.3	7.4	7.1	7.4	7.6	7.4	-	-	-	-	
		Energy Efficiency Class		A++	A++	A++	A++	A++	A++	-	-	-	-	
	Heating (Average Season)	Capacity	Rated	kW	4.1	6.0	7.0	8.0	11.2	11.2	14.0	14.0	16.0	16.0
		Min - Max	kW	1.6 - 5.2	2.5 - 7.3	2.8 - 8.2	3.5 - 10.2	4.5 - 14.0	4.5 - 14.0	5.0 - 16.0	5.0 - 16.0	5.7 - 18.0	5.7 - 18.0	
Total Input		Rated	kW	0.890	1.581	1.863	2.014	2.685	2.685	3.773	3.773	4.365	4.365	
COP				4.61	3.79	3.76	3.97	4.17	4.17	3.71	3.71	3.67	3.67	
		EEL Rank		-	-	-	-	-	-	-	-	-	-	
		Design Load	kW	2.5	3.8	4.4	4.7	7.8	7.8	-	-	-	-	
		Declared Capacity	at reference design temperature	kW	2.5 (-10°C)	3.8 (-10°C)	4.4 (-10°C)	4.7 (-10°C)	7.8 (-10°C)	7.8 (-10°C)	-	-	-	-
			at bivalent temperature	kW	2.5 (-10°C)	3.8 (-10°C)	4.4 (-10°C)	4.7 (-10°C)	7.8 (-10°C)	7.8 (-10°C)	-	-	-	-
			at operation limit temperature	kW	2.1 (-11°C)	3.7 (-11°C)	2.8 (-20°C)	3.5 (-20°C)	5.8 (-20°C)	5.8 (-20°C)	-	-	-	-
		Back Up Heating Capacity	kW	0	0	0	0	0	0	-	-	-	-	
	Annual Electricity Consumption*2	kWh/a	797	1184	1420	1432	2521	2521	-	-	-	-		
	SCOP		4.3	4.4	4.3	4.6	4.3	4.3	-	-	-	-		
	Energy Efficiency Class		A+	A+	A+	A++	A+	A+	-	-	-	-		
Operating Current (max)		A	13.2	13.2	19.2	19.3	27.0	8.5	27.2	10.2	28.7	13.7		
Indoor Unit	Input	Rated	kW	0.03	0.03	0.03	0.04	0.07	0.07	0.10	0.10	0.10		
	Operating Current (max)	A	0.20	0.22	0.24	0.27	0.46	0.46	0.66	0.66	0.66	0.66		
	Dimensions <Panel>	H x W x D	mm	258 - 840	840 <40 - 950	950 - 950	21 <6>	24 <6>	24 <6>	298 - 840	840 <40 - 950	950 - 950		
	Weight <Panel>	kg	19 <6>	19 <6>	21 <6>	21 <6>	24 <6>	24 <6>	26 <6>	26 <6>	26 <6>	26 <6>		
	Air Volume [Lo-Mi2-Mi1-Hi]	m³/min	11-13-15-16	12-14-16-18	12-14-16-18	14-17-19-21	19-23-26-29	19-23-26-29	21-25-28-31	21-25-28-31	24-26-29-32	24-26-29-32		
	Sound Level (SPL) [Lo-Mi2-Mi1-Hi]	dB(A)	26-28-29-31	27-29-31-32	27-29-31-32	28-30-32-34	31-34-37-40	31-34-37-40	33-37-41-44	33-37-41-44	36-39-42-44	36-39-42-44		
	Sound Level (PWL)	dB(A)	51	54	54	56	61	61	65	65	65	65		
	Dimensions	H x W x D	mm	630 - 809	300 - 943	950 - 330 (+25)	70	116	123	1,338 - 1,050	330 (+40)	118	131	
	Weight	kg	46	46	70	70	116	123	116	125	118	131		
	Air Volume	m³/min	45	45	55	55	110	110	120	120	120	120		
Outdoor Unit	Sound Level (SPL)	dB(A)	45	45	55	55	110	110	120	120	120	120		
	Sound Level (SPL)	dB(A)	44	44	47	47	49	49	50	50	50	50		
	Sound Level (PWL)	dB(A)	46	46	49	49	51	51	52	52	52	52		
	Sound Level (PWL)	dB(A)	65	65	67	67	69	69	70	70	70	70		
	Operating Current (max)	A	13.0	13.0	19.0	19.0	26.5	8.0	26.5	9.5	28.0	13.0		
	Breaker Size	A	16	16	25	25	32	16	32	16	40	16		
	Ext. Piping	Diameter	Liquid / Gas	mm	6.35 / 12.7		9.52 / 15.88		9.52 / 15.88		9.52 / 15.88		9.52 / 15.88	
		Max. Length	Out-In	m	50	50	55	55	100	100	100	100	100	
		Max. Height	Out-In	m	30	30	30	30	30	30	30	30	30	
	Guaranteed Operating Range [Outdoor]	Cooling*3	°C	-15 ~ +46	-15 ~ +46	-15 ~ +46	-15 ~ +46	-15 ~ +46	-15 ~ +46	-15 ~ +46	-15 ~ +46	-15 ~ +46	-15 ~ +46	
Heating		°C	-11 ~ +21	-11 ~ +21	-20 ~ +21	-20 ~ +21	-20 ~ +21	-20 ~ +21	-20 ~ +21	-20 ~ +21	-20 ~ +21	-20 ~ +21		

*1 Refrigerant leakage contributes to climate change. Refrigerant with lower global warming potential (GWP) would contribute less to global warming than a refrigerant with higher GWP, if leaked to the atmosphere. This appliance contains a refrigerant fluid with a GWP equal to 550. This means that if 1 kg of this refrigerant fluid would be leaked to the atmosphere, the impact on global warming would be 550 times higher than 1 kg of CO₂ over a period of 100 years. Never try to interfere with the refrigerant circuit yourself or disassemble the product yourself and always ask a professional. The GWP of R32 is 675 in the IPCC 4th Assessment Report.

*2 Energy consumption based on standard test results. Actual energy consumption will depend on how the appliance is used and where it is located.

*3 Optional air protection guide is required where ambient temperature is lower than -5°C.

SERIES SELECTION

Power Inverter Series



Indoor Unit

R32
R410A



Panel PLA-ZM35/50/60/71/100/125/140EA

Panel	With Signal Receiver	With 3D i-see Sensor	With Wireless Remote Controller	With Auto Elevation
PLP-6EA				
PLP-6EAL	✓			
PLP-6EAE		✓		
PLP-6EAL	✓	✓		
PLP-6EAJ	✓			✓
PLP-6EAJE	✓	✓		✓
PLP-6EALM	✓		✓	
PLP-6EALME	✓	✓	✓	

Outdoor Unit

R410A

For Single



PUHZ-ZRP35/50



PUHZ-ZRP60/71



PUHZ-ZRP100/125/140

R410A

For Multi
(Twin/Triple/Quadruple)



PUHZ-ZRP71



PUHZ-ZRP100/125/140/200/250

Remote Controller



Optional



Optional



Optional



* Enclosed in PLP-6EALM/PLP-6EALME

Standard Inverter Series



Indoor Unit

R410A



Panel PLA-M35/50/60/71/100/125/140EA

Panel	With Signal Receiver	With 3D i-see Sensor	With Wireless Remote Controller	With Auto Elevation
PLP-6EA				
PLP-6EAL	✓			
PLP-6EAE		✓		
PLP-6EAL	✓	✓		
PLP-6EAJ	✓			✓
PLP-6EAJE	✓	✓		✓
PLP-6EALM	✓		✓	
PLP-6EALME	✓	✓	✓	

Outdoor Unit

R410A

For Single



SUZ-KA35



SUZ-KA50/60/71



PUHZ-P100/125/140

R410A

For Multi
(Twin/Triple/Quadruple)



PUHZ-P100/125/140



PUHZ-P200/250

Remote Controller



Optional



Optional



Optional



* Enclosed in PLP-6EALM/PLP-6EALME

PLA-ZM/RP EA Indoor Unit Combinations Indoor unit combinations shown below are possible.

Indoor Unit Combination	Outdoor Unit Capacity																				
	For Single									For Twin					For Triple			For Quadruple			
	35	50	60	71	100	125	140	200	250	71	100	125	140	200	250	140	200	250	200	250	
Power Inverter (PUHZ-ZRP)	35x1	50x1	60x1	71x1	100x1	125x1	140x1	-	-	35x2	50x2	60x2	71x2	100x2	125x2	50x3	60x3	71x3	50x4	60x4	
Distribution Pipe	-	-	-	-	-	-	-	-	-	MSDD-50TR-E					MSDD-50WR-E			MSDT-111R-E		MSDF-1111R-E	
Standard Inverter (SUZ & PUHZ-P)	35x1	50x1	60x1	71x1	100x1	125x1	140x1	-	-	-	50x2	60x2	71x2	100x2	125x2	50x3	60x3	71x3	50x4	60x4	
Distribution Pipe	-	-	-	-	-	-	-	-	-	MSDD-50TR-E					MSDD-50WR-E			MSDT-111R-E		MSDF-1111R-E	

PLA-M SERIES

POWER INVERTER



Type		Inverter Heat Pump													
Indoor Unit		PLA-M35EA	PLA-M50EA	PLA-M60EA	PLA-M71EA	PLA-M100EA		PLA-M125EA		PLA-M140EA					
Outdoor Unit		PUHZ-ZRP35VKA2	PUHZ-ZRP50VKA2	PUHZ-ZRP60VHA2	PUHZ-ZRP71VHA2	PUHZ-ZRP100VKA3	PUHZ-ZRP100YKA3	PUHZ-ZRP125VKA3	PUHZ-ZRP125YKA3	PUHZ-ZRP140VKA3	PUHZ-ZRP140YKA3				
Refrigerant		R410A*1													
Power Supply		Outdoor power supply													
Cooling		VKA · VHA:230 / Single / 50, YKA:400 / Three / 50													
Capacity	Rated	kW	3.6	5.0	6.1	7.1	9.5	9.5	12.5	12.5	13.4	13.4			
	Min - Max	kW	1.6 - 4.5	2.3 - 5.6	2.7 - 6.5	3.3 - 8.1	4.9 - 11.4	4.9 - 11.4	5.5 - 14.0	5.5 - 14.0	6.2 - 15.0	6.2 - 15.0			
Total Input	Rated	kW	0.83	1.42	1.75	1.87	2.23	2.23	3.87	3.87	4.39	4.39			
EER			-	-	-	-	-	-	3.23	3.23	3.05	3.05			
EEL Rank			-	-	-	-	-	-	-	-	-	-			
Design Load		kW	3.6	5.0	6.1	7.1	9.5	9.5	-	-	-	-			
Annual Electricity Consumption*2		kWh/a	174	258	321	341	465	476	-	-	-	-			
SEER			7.2	6.7	6.6	7.2	7.1	6.9	-	-	-	-			
Energy Efficiency Class			A++	A++	A++	A++	A++	A++	-	-	-	-			
Heating (Average Season)	Capacity	Rated	kW	4.1	6.0	7.0	8.0	11.2	14.0	14.0	16.0	16.0			
	Min - Max	kW	1.6 - 5.8	2.5 - 7.3	2.8 - 8.2	3.5 - 10.2	4.5 - 14.0	4.5 - 14.0	5.0 - 16.0	5.0 - 16.0	5.7 - 18.0	5.7 - 18.0			
Total Input	Rated	kW	0.92	1.81	2.07	2.11	2.69	2.69	3.77	3.77	4.90	4.90			
COP			-	-	-	-	-	-	3.71	3.71	3.26	3.26			
EEL Rank			-	-	-	-	-	-	-	-	-	-			
Design Load		kW	2.5	3.8	4.4	4.7	7.8	7.8	-	-	-	-			
Declared Capacity	at reference design temperature	kW	2.5 (-10°C)	3.8 (-10°C)	4.4 (-10°C)	4.7 (-10°C)	7.8 (-10°C)	7.8 (-10°C)	-	-	-	-			
	at bivalent temperature	kW	2.5 (-10°C)	3.8 (-10°C)	4.4 (-10°C)	4.7 (-10°C)	7.8 (-10°C)	7.8 (-10°C)	-	-	-	-			
	at operation limit temperature	kW	2.1 (-11°C)	3.7 (-11°C)	2.8 (-20°C)	3.5 (-20°C)	5.8 (-20°C)	5.8 (-20°C)	-	-	-	-			
Back Up Heating Capacity		kW	0	0	0	0	0	0	-	-	-	-			
Annual Electricity Consumption*2		kWh/a	764	1212	1418	1402	2468	2468	-	-	-	-			
SCOP			4.5	4.3	4.3	4.6	4.4	4.4	-	-	-	-			
Energy Efficiency Class			A+	A+	A+	A++	A+	A+	-	-	-	-			
Operating Current (max)			A	13.2	13.2	19.2	19.3	27.0	8.5	27.2	10.2	28.7			
Indoor Unit	Input	Rated	kW	0.03	0.03	0.03	0.04	0.07	0.07	0.10	0.10	0.10			
	Operating Current (max)		A	0.20	0.22	0.24	0.27	0.46	0.46	0.66	0.66	0.66			
Dimensions <Panel>		H × W × D	258 - 840 - 840			<40 - 950 - 950>				298 - 840 - 840			<40 - 950 - 950>		
Weight <Panel>			19 <5>			19 <5>		21 <5>		24 <5>		24 <5>		26 <5>	
Air Volume [Lo-Mi2-Mi1-Hi]		m ³ /min	11-13-15-16	12-14-16-18	12-14-16-18	14-17-19-21	19-23-26-29	19-23-26-29	21-25-28-31	21-25-28-31	24-26-29-32	24-26-29-32			
Sound Level (SPL) [Lo-Mi2-Mi1-Hi]		dB(A)	26-28-29-31	27-29-31-32	27-29-31-32	28-30-32-34	31-34-37-40	31-34-37-40	33-37-41-44	33-37-41-44	36-39-42-44	36-39-42-44			
Sound Level (PWL)		dB(A)	51	54	54	56	61	61	65	65	65	65			
Outdoor Unit	Dimensions	H × W × D	630 - 809 - 300			943 - 950 - 330 (+30)				1338 - 1050 - 330 (+40)					
	Weight		43			46		70		116		123		116	
Air Volume	Cooling	m ³ /min	45	45	55	55	110	110	120	120	120	120			
	Heating	m ³ /min	45	45	55	55	110	110	120	120	120	120			
Sound Level (SPL)	Cooling	dB(A)	44	44	47	47	49	49	50	50	50	50			
	Heating	dB(A)	46	46	48	48	51	51	52	52	52	52			
Sound Level (PWL)	Cooling	dB(A)	65	65	67	67	69	69	70	70	70	70			
	Heating	dB(A)	65	65	67	67	69	69	70	70	70	70			
Operating Current (max)			A	13.0	13.0	19.0	19.0	26.5	8.0	26.5	9.5	28.0			
Breaker Size			A	16	16	25	25	32	16	32	16	40			
Ext. Piping	Diameter	Liquid / Gas	mm	6.35 / 12.7	6.35 / 12.7	9.52 / 15.88	9.52 / 15.88	9.52 / 15.88	9.52 / 15.88	9.52 / 15.88	9.52 / 15.88	9.52 / 15.88			
	Max. Length	Out-In	m	50	50	50	50	75	75	75	75	75			
	Max. Height	Out-In	m	30	30	30	30	30	30	30	30	30			
Guaranteed Operating Range [Outdoor]		Cooling*3	°C	-15 ~ +46	-15 ~ +46	-15 ~ +46	-15 ~ +46	-15 ~ +46	-15 ~ +46	-15 ~ +46	-15 ~ +46	-15 ~ +46			
		Heating	°C	-11 ~ +21	-11 ~ +21	-20 ~ +21	-20 ~ +21	-20 ~ +21	-20 ~ +21	-20 ~ +21	-20 ~ +21	-20 ~ +21			

*1 Refrigerant leakage contributes to climate change. Refrigerant with lower global warming potential (GWP) would contribute less to global warming than a refrigerant with higher GWP, if leaked to the atmosphere. This appliance contains a refrigerant fluid with a GWP equal to 1975. This means that if 1 kg of this refrigerant fluid would be leaked to the atmosphere, the impact on global warming would be 1975 times higher than 1 kg of CO₂, over a period of 100 years. Never try to interfere with the refrigerant circuit yourself or disassemble the product yourself and always ask a professional. The GWP of R410A is 2088 in the IPCC 4th Assessment Report.

*2 Energy consumption based on standard test results. Actual energy consumption will depend on how the appliance is used and where it is located.

*3 Optional air protection guide is required where ambient temperature is lower than -5°C.

PEAD SERIES

R32
R410A



PEAD-M35/50/60/71/100/125/140JA(L)



The thin, ceiling-concealed indoor units of this series are the perfect answer for the air conditioning needs of buildings with minimum ceiling installation space and wide-ranging external static pressure. Energy-saving efficiency has been improved, reducing electricity consumption and contributing to a further reduction in operating cost.

Compact Indoor Units

The height of the models from 35–140 has been unified to 250mm, which makes installation in low ceilings with minimal clearance space possible.

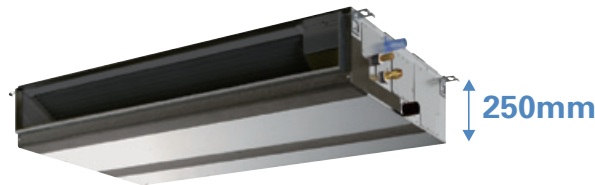

PEAD-M JA(L)

External Static Pressure

External static pressure conversion can be set up to five stages. Capable of being set to a maximum of 150Pa, units are applicable to a wide range of building types.

ErP Lot 10-compliant, Achieving High Energy Efficiency of SEER/SCOP Rank A+ and A++

A direct-current (DC) fan motor is installed in the indoor unit, increasing the seasonal energy efficiency of the newly designed Power Inverter Series (PUHZ-ZRP) and resulting in compliance of the full-capacity models with ErP Lot 10 and energy rankings of A+/A++ for cooling and A/A+ for heating. This contributes to an impressive reduction in the cost of annual electricity.

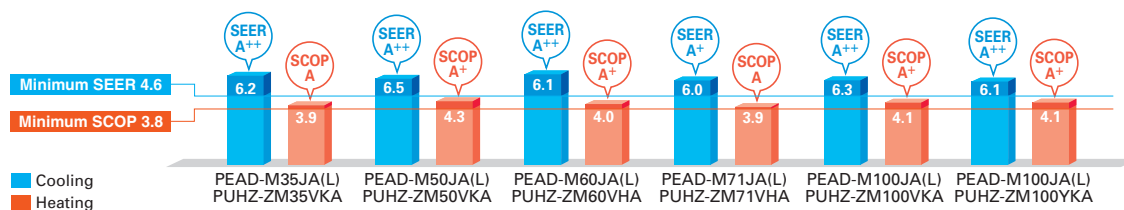

Drain Pump Option Available with All Models

The line-up consists of two types, models with or without a built-in drain pump.



PEAD-M JA → Drain pump built-in



PEAD-M JAL → No drain pump

* Units with an "L" included at the end of the model name are not equipped with a drain pump.

SERIES SELECTION

Power Inverter Series



Indoor Unit

R32
R410A



PEAD-M35/50/60/71/100/125/140

Outdoor Unit

R32

For Single



PUZ-ZM35/50 PUZ-ZM60/71 PUZ-ZM100/125/140

R32

For Multi
(Twin/Triple)



PUZ-ZM71 PUZ-ZM100/125/140

Remote Controller



Optional



Optional



Optional



Optional

PEAD-M JA Indoor Unit Combinations Indoor unit combinations shown below are possible.

Indoor Unit Combination	Outdoor Unit Capacity																			
	For Single									For Twin					For Triple			For Quadruple		
	35	50	60	71	100	125	140	200	250	71	100	125	140	200	250	140	200	250	200	250
Power Inverter (PUZ-ZM)	35x1	50x1	60x1	71x1	100x1	125x1	140x1	-	-	35x2	50x2	60x2	71x2	-	-	50x3	-	-	-	-
Distribution Pipe	-	-	-	-	-	-	-	-	-	MSDD-50TR2-E					-	MSDT-111R2-E			-	

SERIES SELECTION

Standard Inverter Series



Indoor Unit

R32
R410A



PEAD-M35/50/60/71/100/125/140

Outdoor Unit

R32

For Single



SUZ-M35 SUZ-M50 SUZ-M60/71 PUZ-M100/125/140

R32

For Multi
(Twin/Triple)



PUZ-M100/125/140

Remote Controller



Optional



Optional



Optional



Optional

PEAD-M JA Indoor Unit Combinations Indoor unit combinations shown below are possible.

Indoor Unit Combination	Outdoor Unit Capacity																			
	For Single									For Twin					For Triple			For Quadruple		
	35	50	60	71	100	125	140	200	250	71	100	125	140	200	250	140	200	250	200	250
Power Inverter (SUZ-M & PUZ-M)	35x1	50x1	60x1	71x1	100x1	125x1	140x1	-	-	50x2	60x2	71x2	-	-	50x3	-	-	-	-	
Distribution Pipe	-	-	-	-	-	-	-	-	-	MSDD-50TR2-E					-	MSDT-111R2-E			-	

PEAD-M SERIES

POWER INVERTER

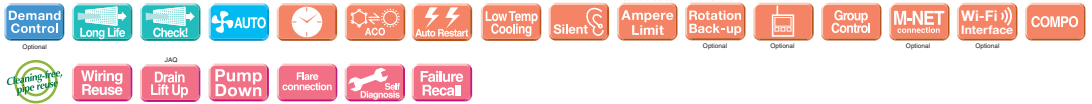

Type	Inverter Heat Pump												
Indoor Unit	PEAD-M35JA(L)	PEAD-M50JA(L)	PEAD-M60JA(L)	PEAD-M71JA(L)	PEAD-M100JA(L)	PEAD-M125JA(L)	PEAD-M140JA(L)	PEAD-M125JA(L)	PEAD-M125JA(L)	PEAD-M140JA(L)	PEAD-M140JA(L)	PEAD-M140JA(L)	
Outdoor Unit	PUZ-ZM35VKA	PUZ-ZM50VKA	PUZ-ZM60VKA	PUZ-ZM71VKA	PUZ-ZM100VKA	PUZ-ZM100VKA	PUZ-ZM125VKA	PUZ-ZM125VKA	PUZ-ZM125VKA	PUZ-ZM140VKA	PUZ-ZM140VKA	PUZ-ZM140VKA	
Refrigerant	R32*1												
Power Supply	Outdoor power supply												
Source	VKA · VHA:230 / Single / 50, YKA:400 / Three / 50												
Outdoor (V/Phase/Hz)													
Cooling	Capacity	Rated	kW	3.6	5.0	6.1	7.1	9.5	9.5	12.5	12.5	13.4	13.4
	Min - Max	kW	1.6 - 4.5	2.3 - 5.6	2.7 - 6.7	3.3 - 8.1	4.9 - 11.4	4.9 - 11.4	5.5 - 14.0	5.5 - 14.0	6.2 - 15.3	6.2 - 15.3	6.2 - 15.3
	Total Input	Rated	kW	0.837(0.820)	1.201(1.187)	1.509(1.495)	1.858(1.844)	2.272(2.256)	2.272(2.256)	3.333(3.315)	3.333(3.315)	3.631(3.611)	3.631(3.611)
	EER*5	Rated		4.30(4.39)	4.16(4.21)	4.04(4.08)	3.82(3.85)	4.18(4.21)	4.18(4.21)	3.75(3.77)	3.75(3.77)	3.69(3.71)	3.69(3.71)
	EEL Rank			-	-	-	-	-	-	-	-	-	-
Heating (Average Season)	Capacity	Rated	kW	4.1	6.0	7.0	8.0	11.2	11.2	14.0	14.0	16.0	16.0
	Min - Max	kW	1.6 - 5.2	2.5 - 7.3	2.8 - 8.2	3.5 - 10.2	4.5 - 14.0	4.5 - 14.0	5.0 - 16.0	5.0 - 16.0	5.7 - 18.0	5.7 - 18.0	
	Total Input	Rated	kW	0.917	1.312	1.616	1.932	2.598	2.598	3.349	3.349	3.970	3.970
	COP*5	Rated		4.47	4.57	4.33	4.14	4.31	4.31	4.18	4.18	4.03	4.03
	EEL Rank			-	-	-	-	-	-	-	-	-	-

*1 Refrigerant leakage contributes to climate change. Refrigerant with lower global warming potential (GWP) would contribute less to global warming than a refrigerant with higher GWP. If leaked to the atmosphere, this appliance contains a refrigerant fluid with a GWP equal to 550. This means that if 1 kg of this refrigerant fluid would be leaked to the atmosphere, the impact on global warming would be 550 times higher than 1 kg of CO₂, over a period of 100 years. Never try to interfere with the refrigerant circuit yourself or disassemble the product yourself and always ask a professional. The GWP of R32 is 675 in the IPCC 4th Assessment Report.

*2 Energy consumption based on standard test results. Actual energy consumption will depend on how the appliance is used and where it is located.

*3 Optional air protection guide is required where ambient temperature is lower than -5°C. *4 EER/COP and SEER/SCOP for RP35-71 are measured at ESP 35Pa, for RP100 at ESP 37Pa, for RP125/140 at ESP 50Pa.

PEAD-M SERIES

STANDARD INVERTER

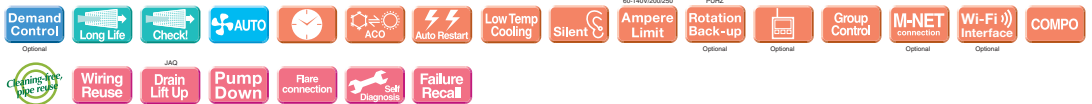

Type	Inverter Heat Pump												
Indoor Unit	PEAD-M35JA(L)	PEAD-M50JA(L)	PEAD-M60JA(L)	PEAD-M71JA(L)	PEAD-M100JA(L)	PEAD-M125JA(L)	PEAD-M140JA(L)	PEAD-M125JA(L)	PEAD-M125JA(L)	PEAD-M140JA(L)	PEAD-M140JA(L)	PEAD-M140JA(L)	
Outdoor Unit	SUZ-M35VA	SUZ-M50VA	SUZ-M60VA	SUZ-M71VA	PUZ-M100VKA	PUZ-M100VKA	PUZ-M125VKA	PUZ-M125VKA	PUZ-M125VKA	PUZ-M140VKA	PUZ-M140VKA	PUZ-M140VKA	
Refrigerant	R32*1												
Power Supply	Outdoor power supply												
Source	VA · VKA: 230 / Single / 50, YKA: 400 / Three / 50												
Outdoor (V/Phase/Hz)													
Cooling	Capacity	Rated	kW	3.6	5.0	6.1	7.1	9.5	9.5	12.1	12.1	13.4	13.4
	Min - Max	kW	0.8 - 3.9	1.7 - 5.6	1.6 - 6.3	2.2 - 8.1	4.0 - 10.6	4.0 - 10.6	6.0 - 13.0	6.0 - 13.0	6.1 - 14.1	6.1 - 14.1	
	Total Input	Rated	kW	0.92(0.90)	1.35(1.33)	1.69(1.67)	2.02(2.00)	2.87(2.85)	2.87(2.85)	4.01(3.99)	4.01(3.99)	4.76	4.76
	EER*5	Rated		3.90(4.00)	3.70(3.75)	3.60(3.65)	3.50(3.55)	3.30(3.33)	3.30(3.33)	3.01(3.03)	3.01(3.03)	2.81	2.81
	EEL Rank			-	-	-	-	-	-	-	-	-	-
Heating (Average Season)	Capacity	Rated	kW	4.1	6.0	7.0	8.0	11.2	11.2	13.5	13.5	15.0	15.0
	Min - Max	kW	1.1 - 5.0	1.5 - 7.2	1.6 - 8.0	2.0 - 10.2	2.8 - 12.5	2.8 - 12.5	4.1 - 15.0	4.1 - 15.0	4.2 - 15.8	4.2 - 15.8	
	Total Input	Rated	kW	1.02	1.46	1.84	2.15	2.94	2.94	3.73	3.73	4.15	4.15
	COP*5	Rated		4.00	4.10	3.80	3.71	3.80	3.80	3.61	3.61	3.61	3.61
	EEL Rank			-	-	-	-	-	-	-	-	-	-

*1 Refrigerant leakage contributes to climate change. Refrigerant with lower global warming potential (GWP) would contribute less to global warming than a refrigerant with higher GWP. If leaked to the atmosphere, this appliance contains a refrigerant fluid with a GWP equal to 550. This means that if 1 kg of this refrigerant fluid would be leaked to the atmosphere, the impact on global warming would be 550 times higher than 1 kg of CO₂, over a period of 100 years. Never try to interfere with the refrigerant circuit yourself or disassemble the product yourself and always ask a professional. The GWP of R32 is 675 in the IPCC 4th Assessment Report.

*2 Energy consumption based on standard test results. Actual energy consumption will depend on how the appliance is used and where it is located.

*3 Optional air protection guide is required where ambient temperature is lower than -5°C. *4 EER/COP and SEER/SCOP for RP35-71 are measured at ESP 35Pa, for RP100 at ESP 37Pa, for RP125/140 at ESP 50Pa.

SERIES SELECTION

Power Inverter Series



Indoor Unit

R32
R410A



PEAD-M35/50/60/71/100/125/140

Outdoor Unit

R410A

For Single



PUHZ-ZRP35/50



PUHZ-ZRP60/71



PUHZ-ZRP100/125/140

R410A

For Multi
(Twin/Triple/Quadruple)



PUHZ-ZRP71



PUHZ-ZRP100/125/140/200/250

Remote Controller



Optional



Optional



Optional



Optional

Standard Inverter Series



Indoor Unit

R32
R410A



PEAD-M35/50/60/71/100/125/140

Outdoor Unit

R410A

For Single

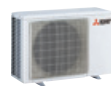

SUZ-KA35



SUZ-KA50/60/71



PUHZ-P100/125/140

R410A

For Multi
(Twin/Triple/Quadruple)



PUHZ-P100/125/140



PUHZ-P200/250

Remote Controller



Optional



Optional



Optional



Optional

PEAD-M JA(L) Indoor Unit Combinations Indoor unit combinations shown below are possible.

Indoor Unit Combination	Outdoor Unit Capacity																				
	For Single										For Twin					For Triple			For Quadruple		
	35	50	60	71	100	125	140	200	250	71	100	125	140	200	250	140	200	250	200	250	
Power Inverter (PUHZ-ZRP)	35x1	50x1	60x1	71x1	100x1	125x1	140x1	-	-	35x2	50x2	60x2	71x2	100x2	125x2	50x3	60x3	71x3	50x4	60x4	
Distribution Pipe	-	-	-	-	-	-	-	-	-	MSDD-50TR-E					MSDD-50WR-E			MSDT-111R-E		MSDF-1111R-E	
Standard Inverter (PUHZ-P&SUZ)	35x1	50x1	60x1	71x1	100x1	125x1	140x1	-	-	-	50x2	60x2	71x2	100x2	125x2	50x3	60x3	71x3	50x4	60x4	
Distribution Pipe	-	-	-	-	-	-	-	-	-	MSDD-50TR-E					MSDD-50WR-E			MSDT-111R-E		MSDF-1111R-E	

PEAD-M SERIES

POWER INVERTER

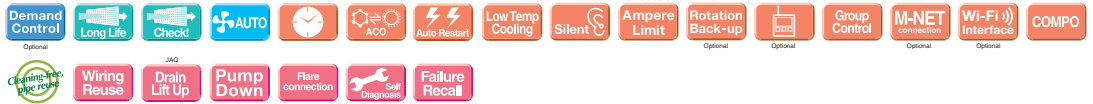

Type		Inverter Heat Pump											
Indoor Unit		PEAD-M35JA(L)	PEAD-M50JA(L)	PEAD-M60JA(L)	PEAD-M71JA(L)	PEAD-M100JA(L)		PEAD-M125JA(L)		PEAD-M140JA(L)			
Outdoor Unit		PUHZ-ZRP35VKA2	PUHZ-ZRP50VKA2	PUHZ-ZRP60VHA2	PUHZ-ZRP71VHA2	PUHZ-ZRP100VKA3	PUHZ-ZRP100YKA3	PUHZ-ZRP125VKA3	PUHZ-ZRP125YKA3	PUHZ-ZRP140VKA3	PUHZ-ZRP140YKA3		
Refrigerant		R410A**											
Power Source		Outdoor power supply											
Supply Outdoor (V/Phase/Hz)		VKA · VHA:230 / Single / 50, YKA:400 / Three / 50											
Cooling	Capacity	Rated	kW	3.6	5.0	6.1	7.1	9.5	9.5	12.5	12.5	13.4	13.4
	Min - Max	kW	1.6 - 4.5	2.3 - 5.6	2.7 - 6.7	3.3 - 8.1	4.9 - 11.4	4.9 - 11.4	5.5 - 14.0	5.5 - 14.0	6.2 - 15.3	6.2 - 15.3	6.2 - 15.3
	Total Input	Rated	kW	0.89(0.87)	1.44(1.42)	1.65(1.63)	2.01(1.99)	2.43(2.41)	2.43(2.41)	3.86(3.83)	3.86(3.83)	4.32(4.29)	4.32(4.29)
	EER [†]									3.24(3.26)	3.24(3.26)	3.10(3.12)	3.10(3.12)
	EEL Rank												
Heating (Average Season)	Capacity	Rated	kW	4.1	6.0	7.0	8.0	11.2	11.2	14.0	14.0	16.0	16.0
	Min - Max	kW	1.6 - 5.2	2.5 - 7.3	2.8 - 8.2	3.5 - 10.2	4.5 - 14.0	4.5 - 14.0	5.0 - 16.0	5.0 - 16.0	5.7 - 18.0	5.7 - 18.0	
	Total Input	Rated	kW	0.95	1.50	1.79	2.03	2.60	2.60	3.51	3.51	4.07	4.07
	COP [‡]									3.99	3.99	3.93	3.93
	EEL Rank												

*1 Refrigerant leakage contributes to climate change. Refrigerant with lower global warming potential (GWP) would contribute less to global warming than a refrigerant with higher GWP, if leaked to the atmosphere. This appliance contains a refrigerant fluid with a GWP equal to 1975. This means that if 1 kg of this refrigerant fluid would be leaked to the atmosphere, the impact on global warming would be 1975 times higher than 1 kg of CO₂ over a period of 100 years. Never try to interfere with the refrigerant circuit yourself or disassemble the product yourself and always ask a professional. The GWP of R410A is 2088 in the IPCC 4th Assessment Report.

*2 Energy consumption based on standard test results. Actual energy consumption will depend on how the appliance is used and where it is located.

*3 Optional air protection guide is required where ambient temperature is lower than -5°C. *4 EER/COP and SEER/SCOP for RP35-71 are measured at ESP 35Pa, for RP100 at ESP 37Pa, for RP125/140 at ESP 50Pa.

PEAD-M SERIES

STANDARD INVERTER

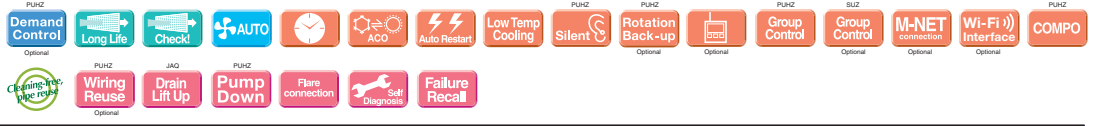

Type		Inverter Heat Pump											
Indoor Unit		PEAD-M35JA(L)	PEAD-M50JA(L)	PEAD-M60JA(L)	PEAD-M71JA(L)	PEAD-M100JA(L)		PEAD-M125JA(L)		PEAD-M140JA(L)			
Outdoor Unit		SUZ-KA35VA6	SUZ-KA50VA6	SUZ-KA60VA6	SUZ-KA71VA6	PUHZ-P100VKA	PUHZ-P100YKA	PUHZ-P125VKA	PUHZ-P125YKA	PUHZ-P140VKA	PUHZ-P140YKA		
Refrigerant		R410A**											
Power Source		Outdoor power supply											
Supply Outdoor (V/Phase/Hz)		VA · VKA:230 / Single / 50, YKA:400 / Three / 50											
Cooling	Capacity	Rated	kW	3.6	4.9	5.7	7.1	9.4	9.4	12.1	12.1	13.6	13.6
	Min - Max	kW	1.4 - 3.9	2.3 - 5.6	2.3 - 6.3	2.8 - 8.1	3.7 - 10.6	3.7 - 10.6	5.6 - 13.0	5.6 - 13.0	5.8 - 14.1	5.8 - 14.1	
	Total Input	Rated	kW	1.050(1.030)	1.480(1.460)	1.670(1.650)	2.080(2.060)	2.98(2.96)	2.98(2.96)	4.15(4.14)	4.15(4.14)	5.21(5.19)	5.21(5.19)
	EER [†]									2.91(2.92)	2.91(2.92)	2.61(2.62)	2.61(2.62)
	EEL Rank												
Heating (Average Season)	Capacity	Rated	kW	4.1	5.9	7.0	8.0	11.2	11.2	13.5	13.5	15.0	15.0
	Min - Max	kW	1.7 - 5.0	1.7 - 7.2	2.5 - 8.0	2.6 - 10.2	2.8 - 12.5	2.8 - 12.5	4.8 - 15.0	4.8 - 15.0	4.9 - 15.8	4.9 - 15.8	
	Total Input	Rated	kW	1.110	1.620	1.930	2.040	2.94	2.94	3.73	3.73	4.27	4.27
	COP [‡]									3.61	3.61	3.51	3.51
	EEL Rank												

*1 Refrigerant leakage contributes to climate change. Refrigerant with lower global warming potential (GWP) would contribute less to global warming than a refrigerant with higher GWP, if leaked to the atmosphere. This appliance contains a refrigerant fluid with a GWP equal to 1975. This means that if 1 kg of this refrigerant fluid would be leaked to the atmosphere, the impact on global warming would be 1975 times higher than 1 kg of CO₂ over a period of 100 years. Never try to interfere with the refrigerant circuit yourself or disassemble the product yourself and always ask a professional. The GWP of R410A is 2088 in the IPCC 4th Assessment Report.

*2 Energy consumption based on standard test results. Actual energy consumption will depend on how the appliance is used and where it is located.

*3 Optional air protection guide is required where ambient temperature is lower than -5°C. *4 EER/COP and SEER/SCOP for RP35-71 are measured at ESP 35Pa, for RP100 at ESP 37Pa, for RP125/140 at ESP 50Pa.

PEA SERIES

For elegance and style, the PEA Series complements the room environment with an aesthetically pleasing ceiling installation and a vast line-up of performance functions. Long pipe work installation is supported, increasing freedom in the placement of indoor units.

R410A

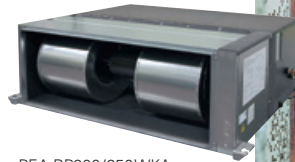

PEA-RP200/250WKA



Flexible Duct Design Enables Use of High-pressure Static Fan

A flexible duct design and 150Pa external static high-pressure are incorporated. The increased variation in airflow options ensures operation that best matches virtually all room layouts.

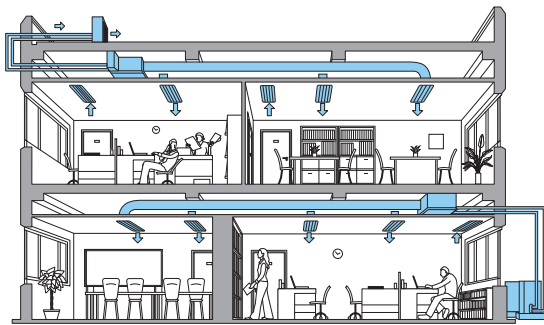

Long Refrigerant Piping Length

With the addition of more refrigerant, the maximum length for refrigerant piping has been increased to 100 metres. As a result, it is much easier to create the optimum layout for unit installation.

		Power Inverter Connection		Standard Inverter Connection	
		Max. Length	Max. Height	Max. Length	Max. Height
PEA-RP	200	100m	30m	70m	30m
	250	100m	30m	70m	30m

Wide-ranging Line-up from 20–25kW – Extensive Array of Choices to Match Building Size

[System Image]

PEA-RP200/250WKA

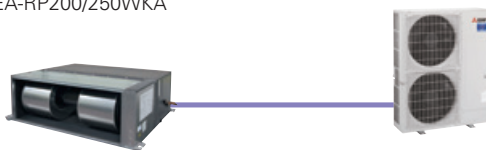

• For PEA-200, 250

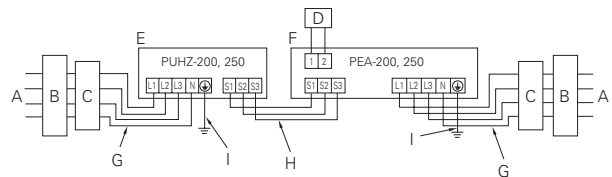

PAR-40MAA Group Control

The PAR-40MAA remote controller can control up to 16 systems* as a group, and is ideal for supporting the integrated management of building air conditioners.

• For PEA-200, 250

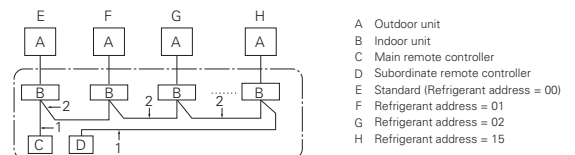

LINE-UP		
<p>Indoor Unit</p> <p>R410A</p> <p>PEA-RP200/250WKA</p>	<p>Outdoor Unit</p> <p>Power Inverter Series</p> <p>R410A</p> <p>PUHZ-ZRP200/250</p> <p>Standard Inverter Series</p> <p>R410A</p> <p>PUHZ-P200/250</p>	<p>Remote Controller</p> <p>Optional</p> <p>Optional</p> <p>Optional</p>

PEA-RP SERIES

POWER INVERTER



Type				Inverter Heat Pump		
Indoor Unit				PEA-RP200WKA	PEA-RP250WKA	
Outdoor Unit				PUHZ-ZRP200YKA3	PUHZ-ZRP250YKA3	
Refrigerant				R410A*1		
Power Supply		Source		Outdoor power supply		
Outdoor (V/Phase/Hz)				400 / Three / 50		
Cooling	Capacity	Rated	kW	19.0	22.0	
		Min - Max	kW	9.0 - 22.4	11.2 - 27.0	
	Total Input	Rated	kW	6.03	8.05	
	EER			3.15	2.73	
		EEL Rank				
				-		
Heating (Average Season)	Capacity	Rated	kW	22.4	27.0	
		Min - Max	kW	9.5 - 25.0	12.5 - 31.0	
	Total Input	Rated	kW	6.58	8.43	
	COP			3.40	3.20	
		EEL Rank				
				-		
Operating Current (max)				23.3	26.5	
Indoor Unit	Input [Cooling / Heating]	Rated	kW	0.66	0.80	
	Operating Current (max)		A	4.3	5.5	
	Dimensions		H x W x D	mm	470 - 1370 - 1120	
	Weight		kg	108		
	Air Volume [Lo-Hi]		m³/min	50 - 61 - 72	58 - 71 - 84	
	External Static Pressure		Pa	(60) / (75) / (100) / 150		
	Sound Level (SPL) [Lo-Hi]		dB(A)	38 - 41 - 44	40 - 43 - 46	
	Sound Level (PWL)		dB(A)	65 - 66 - 67	70 - 71 - 72	
	Outdoor Unit	Dimensions		H x W x D	mm	1338 - 1050 - 330 (+40)
		Weight		kg	135	135
Air Volume		Cooling	m³/min	140	140	
		Heating	m³/min	140	140	
Sound Level (SPL)		Cooling	dB(A)	59	59	
		Heating	dB(A)	62	62	
Sound Level (PWL)		Cooling	dB(A)	77	77	
		Operating Current (max)		A	19.0	21.0
Breaker Size		A	32	32		
Ext. Piping		Diameter	Liquid / Gas	mm	9.52 / 25.4	12.7 / 25.4
	Max. Length	Out-In	m	100	100	
	Max. Height	Out-In	m	30	30	
Guaranteed Operating Range [Outdoor]		Cooling*3	°C	-15 ~ +46	-15 ~ +46	
		Heating	°C	-20 ~ +21	-20 ~ +21	

*1 Refrigerant leakage contributes to climate change. Refrigerant with lower global warming potential (GWP) would contribute less to global warming than a refrigerant with higher GWP, if leaked to the atmosphere. This appliance contains a refrigerant fluid with a GWP equal to 1975. This means that if 1 kg of this refrigerant fluid would be leaked to the atmosphere, the impact on global warming would be 1975 times higher than 1 kg of CO₂, over a period of 100 years. Never try to interfere with the refrigerant circuit yourself or disassemble the product yourself and always ask a professional. The GWP of R410A is 2088 in the IPCC 4th Assessment Report.

*2 Energy consumption based on standard test results. Actual energy consumption will depend on how the appliance is used and where it is located.

*3 Optional air protection guide is required where ambient temperature is lower than -5°C.

PEA-RP SERIES

STANDARD INVERTER



Type				Inverter Heat Pump		
Indoor Unit				PEA-RP200WKA	PEA-RP250WKA	
Outdoor Unit				PUHZ-P200YKA3	PUHZ-P250YKA3	
Refrigerant				R410A*1		
Power Supply		Source		Outdoor power supply		
Outdoor (V/Phase/Hz)				400 / Three / 50		
Cooling	Capacity	Rated	kW	19.0	22.0	
		Min - Max	kW	9.0 - 22.4	11.2 - 27.0	
	Total Input	Rated	kW	6.29	8.14	
	EER			3.02	2.70	
		EEL Rank				
				-		
Heating (Average Season)	Capacity	Rated	kW	22.4	27.0	
		Min - Max	kW	9.5 - 25.0	12.5 - 31.0	
	Total Input	Rated	kW	6.78	8.70	
	COP			3.30	3.10	
		EEL Rank				
				-		
Operating Current (max)				23.3	26.5	
Indoor Unit	Input [Cooling / Heating]	Rated	kW	0.66	0.80	
	Operating Current (max)		A	4.3	5.5	
	Dimensions		H x W x D	mm	470 - 1370 - 1120	
	Weight		kg	108		
	Air Volume [Lo-Hi]		m³/min	50 - 61 - 72	58 - 71 - 84	
	External Static Pressure		Pa	(60) / (75) / (100) / 150		
	Sound Level (SPL) [Lo-Mid-Hi]		dB(A)	38 - 41 - 44	40 - 43 - 46	
	Sound Level (PWL)		dB(A)	65 - 66 - 67	70 - 71 - 72	
	Outdoor Unit	Dimensions		H x W x D	mm	1338 - 1050 - 330 (+40)
		Weight		kg	127	135
Air Volume		Cooling	m³/min	140	140	
		Heating	m³/min	140	140	
Sound Level (SPL)		Cooling	dB(A)	58	59	
		Heating	dB(A)	60	62	
Sound Level (PWL)		Cooling	dB(A)	78	77	
		Operating Current (max)		A	19.0	21.0
Breaker Size		A	32	32		
Ext. Piping		Diameter	Liquid / Gas	mm	9.52 / 25.4	12.7/25.4
	Max. Length	Out-In	m	70	70	
	Max. Height	Out-In	m	30	30	
Guaranteed Operating Range [Outdoor]		Cooling*3	°C	-15 ~ +46	-15 ~ +46	
		Heating	°C	-20 ~ +21	-20 ~ +21	

*1 Refrigerant leakage contributes to climate change. Refrigerant with lower global warming potential (GWP) would contribute less to global warming than a refrigerant with higher GWP, if leaked to the atmosphere. This appliance contains a refrigerant fluid with a GWP equal to 1975. This means that if 1 kg of this refrigerant fluid would be leaked to the atmosphere, the impact on global warming would be 1975 times higher than 1 kg of CO₂, over a period of 100 years. Never try to interfere with the refrigerant circuit yourself or disassemble the product yourself and always ask a professional. The GWP of R410A is 2088 in the IPCC 4th Assessment Report.

*2 Energy consumption based on standard test results. Actual energy consumption will depend on how the appliance is used and where it is located.

*3 Optional air protection guide is required where ambient temperature is lower than -5°C.

PKA SERIES

The compact, wall-mounted indoor units offer the convenience of simple installation, and a large product line-up (M35-M100 models) ensures a best-match solution. Designed for highly efficient energy savings, the PKA Series is the answer to your air conditioning needs.

PKA-M35/50HA(L)

R32
R410A



PKA-M60/71/100KA(L)

R32
R410A



Wired & Wireless Model

Wired models are newly added in P Series line-up. The diverse selection enables the base solution for both customer and location.



Flat Panel & Pure White Finish

A flat panel layout has been adopted for all models. Pursuing a design that harmonizes with virtually any interior, the unit colour has been changed from white to pure white.



PKA-M HA(L)



PKA-M KA(L)



Flat panel is easy to clean!

ErP Lot 10 Compliant with High Energy-efficiency Achieving SEER/SCOP Rank A, A+ and A++

Highly efficient indoor unit heat exchangers and newly designed power inverters (PUHZ-ZM) contribute to an amazing reduction in electricity consumption throughout a year, and have resulted in models in the full-capacity range attaining the rank A, A+ and A++ energy savings rating.

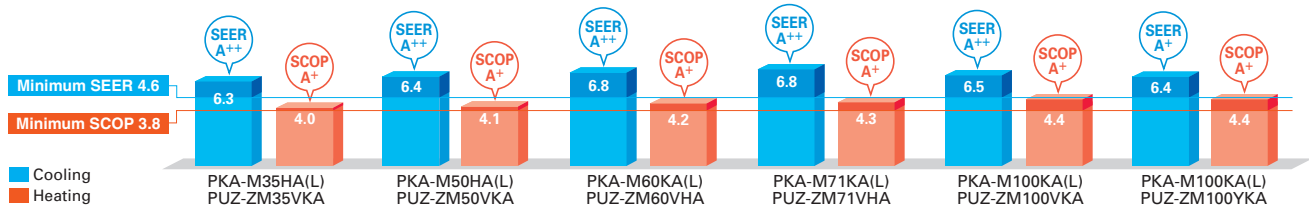

Drain Pump Option Available with All Models

Installation of the drain pump enables a drain outlet as high as 800mm above the base of the indoor unit. Drain water can be discharged easily even if the surface where the wall-mounted unit does not have direct access outside, increasing the degree of freedom for installation.

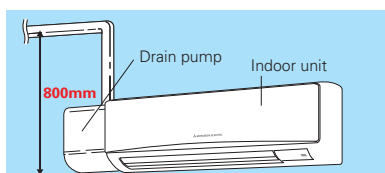

Multi-function Wired Remote Controller

In addition to using the wireless remote controller that comes as standard equipment, PAR-40MAA and PAC-YT52CRA wired remote controllers can be used as well.

* Connection to PAR-40MAA/PAC-YT52CRA requires PAC-SH29TC-E (optional).

Main Functions

- Night Setback
- Energy-saving Mode
- Multi Language
- Weekly Timer
- Refrigerant Leak Check

* For details, please refer to page 175.



SERIES SELECTION

Power Inverter Series



Indoor Unit

R32
R410A



PKA-M35/50HA(L)

R32
R410A



PKA-M60/71/100KA(L)

Outdoor Unit

R32

For Single



PUZ-ZM35/50



PUZ-ZM60/71



PUZ-ZM100/125/140

R32

For Multi
(Twin/Triple)



PUZ-ZM71



PUZ-ZM100/125/140

Remote Controller



Optional (*)



Optional



Optional (*)



(*) PAC-SH29TC-E is required (optional)

PKA-M HA(L)/KA(L) Indoor Unit Combinations Indoor unit combinations shown below are possible.

Indoor Unit Combination	Outdoor Unit Capacity																				
	For Single									For Twin						For Triple			For Quadruple		
	35	50	60	71	100	125	140	200	250	71	100	125	140	200	250	140	200	250	200	250	
Power Inverter (PUZ-ZM)	35x1	50x1	60x1	71x1	100x1	-	-	-	-	35x2	50x2	60x2	71x2	-	-	50x3	-	-	-	-	
Distribution Pipe	-	-	-	-	-	-	-	-	-	MSDD-50TR2-E						-	-	MSDT-111R2-E			-

SERIES SELECTION

Standard Inverter Series



Indoor Unit

R32
R410A



PKA-M35/50HA(L)



PKA-M60/71/100KA(L)

Outdoor Unit

R32

For Single



PUZ-M100

R32

For Multi
(Twin/Triple)



PUZ-M100/125/140

Remote Controller



Optional (*)



Optional



Optional (*)



(*) PAC-SH29TC-E is required (optional)

PKA-M HA/KA Indoor Unit Combinations Indoor unit combinations shown below are possible.

Indoor Unit Combination	Outdoor Unit Capacity																				
	For Single									For Twin						For Triple			For Quadruple		
	35	50	60	71	100	125	140	200	250	71	100	125	140	200	250	140	200	250	200	250	
Standard Inverter (PUZ-M)	-	-	-	-	100x1	-	-	-	-	-	50x2	60x2	71x2	-	-	50x3	-	-	-	-	
Distribution Pipe	-	-	-	-	-	-	-	-	-	MSDD-50TR2-E						-	-	MSDT-111R2-E			-

PKA-M SERIES

POWER INVERTER



Type			Inverter Heat Pump						
Indoor Unit			PKA-M35HA(L)	PKA-M50HA(L)	PKA-M60KA(L)	PKA-M71KA(L)	PKA-M100KA(L)		
Outdoor Unit			PUZ-ZM35VKA	PUZ-ZM50VKA	PUZ-ZM60VKA	PUZ-ZM71VKA	PUZ-ZM100VKA	PUZ-ZM100YKA	
Refrigerant			R32*1						
Power Supply			Outdoor power supply						
Source			VKA · VHA:230 / Single / 50, YKA:400 / Three / 50						
Outdoor (V/Phase/Hz)									
Cooling	Capacity	Rated	kW	3.6	4.6	6.1	7.1	9.5	9.5
		Min - Max	kW	1.6 - 4.5	2.3 - 5.6	2.7 - 6.7	3.3 - 8.1	4.9 - 11.4	4.9 - 11.4
	Total Input	Rated	kW	0.869	1.239	1.560	1.863	2.405	2.405
		Rated	kW	4.14	3.71	3.91	3.81	3.95	3.95
	EER								
	EEL Rank			-					
	Design Load			kW					
	Annual Electricity Consumption*2			kWh/a					
	SEER			6.3					
Energy Efficiency Class			A++						
Heating (Average Season)	Capacity	Rated	kW	4.1	5.0	7.0	8.0	11.2	11.2
		Min - Max	kW	1.6 - 5.2	2.5 - 7.3	2.8 - 8.2	3.5 - 10.2	4.5 - 14.0	4.5 - 14.0
	Total Input	Rated	kW	1.040	1.347	1.732	2.116	3.102	3.102
		Rated	kW	3.94	3.71	4.04	3.78	3.61	3.61
	COP								
	EEL Rank			-					
	Design Load			kW					
	Declared Capacity			at reference design temperature					
				at bivalent temperature					
			at operation limit temperature						
Back Up Heating Capacity			kW						
Annual Electricity Consumption*2			kWh/a						
SCOP			4.0						
Energy Efficiency Class			A+						
Operating Current (max)	Input	Rated	A	13.4	13.4	19.4	19.4	27.1	8.6
		Rated	kW	0.04 / 0.03	0.04 / 0.03	0.06 / 0.05	0.06 / 0.05	0.08 / 0.07	0.08 / 0.07
	Operating Current (max)			A					
	Dimensions <Panel>			mm					
	Weight <Panel>			kg					
	Air Volume [Lo-Mid-Hi]			m³/min					
	Sound Level (SPL) [Lo-Mid-Hi]			dB(A)					
	Sound Level (PWL)			dB(A)					
	Outdoor Unit			mm					
	Dimensions			630 - 809 - 300					
Weight			kg						
Air Volume			m³/min						
Sound Level (SPL)			dB(A)						
Sound Level (PWL)			dB(A)						
Operating Current (max)			A						
Breaker Size			A						
Ext. Piping	Diameter	Liquid / Gas	mm	6.35 / 12.7	6.35 / 12.7	9.52 / 15.88	9.52 / 15.88	9.52 / 15.88	9.52 / 15.88
	Max. Length	Out-In	m	50	50	55	55	100	100
	Max. Height	Out-In	m	30	30	30	30	30	30
	Guaranteed Operating Range [Outdoor]	Cooling*3	°C	-15 ~ +46	-15 ~ +46	-15 ~ +46	-15 ~ +46	-15 ~ +46	-15 ~ +46
	Heating	°C	-11 ~ +21	-11 ~ +21	-20 ~ +21	-20 ~ +21	-20 ~ +21	-20 ~ +21	

*1 Refrigerant leakage contributes to climate change. Refrigerant with lower global warming potential (GWP) would contribute less to global warming than a refrigerant with higher GWP, if leaked to the atmosphere. This appliance contains a refrigerant fluid with a GWP equal to 550. This means that if 1 kg of this refrigerant fluid would be leaked to the atmosphere, the impact on global warming would be 550 times higher than 1 kg of CO₂, over a period of 100 years. Never try to interfere with the refrigerant circuit yourself or disassemble the product yourself and always ask a professional. The GWP of R32 is 675 in the IPCC 4th Assessment Report.

*2 Energy consumption based on standard test results. Actual energy consumption will depend on how the appliance is used and where it is located.

*3 Optional air protection guide is required where ambient temperature is lower than -5°C.

PKA-M SERIES

STANDARD INVERTER



Type			Inverter Heat Pump						
Indoor Unit			PKA-M100KA(L)						
Outdoor Unit			PUZ-M100VKA			PUZ-M100YKA			
Refrigerant			R32*1						
Power Supply			Outdoor power supply						
Source			230 / Single / 50						
Outdoor (V/Phase/Hz)			400 / Three / 50						
Cooling	Capacity	Rated	kW	9.5					
		Min - Max	kW	4.0 - 10.6					
	Total Input	Rated	kW	2.94					
		Rated	kW	3.23					
	EER								
	EEL Rank			-					
	Design Load			kW					
	Annual Electricity Consumption*2			kWh/a					
	SEER			5.8					
Energy Efficiency Class			A+						
Heating (Average Season)	Capacity	Rated	kW	11.2					
		Min - Max	kW	2.8 - 12.5					
	Total Input	Rated	kW	3.28					
		Rated	kW	3.41					
	COP								
	EEL Rank			-					
	Design Load			kW					
	Declared Capacity			at reference design temperature					
				at bivalent temperature					
			at operation limit temperature						
Back Up Heating Capacity			kW						
Annual Electricity Consumption*2			kWh/a						
SCOP			4.0						
Energy Efficiency Class			A+						
Operating Current (max)	Input	Rated	A	20.6					
		Rated	kW	0.08					
	Operating Current (max)			A					
	Dimensions <Panel>			mm					
	Weight <Panel>			kg					
	Air Volume [Lo-Mid-Hi]			m³/min					
	Sound Level (SPL) [Lo-Mid-Hi]			dB(A)					
	Sound Level (PWL)			dB(A)					
	Outdoor Unit			mm					
	Dimensions			981 - 1050 - 330 (+40)					
Weight			kg						
Air Volume			m³/min						
Sound Level (SPL)			dB(A)						
Sound Level (PWL)			dB(A)						
Operating Current (max)			A						
Breaker Size			A						
Ext. Piping	Diameter	Liquid / Gas	mm	9.52 / 15.88					
	Max. Length	Out-In	m	55					
	Max. Height	Out-In	m	30					
	Guaranteed Operating Range [Outdoor]	Cooling*3	°C	-15 ~ +46					
	Heating	°C	-15 ~ +21						

*1 Refrigerant leakage contributes to climate change. Refrigerant with lower global warming potential (GWP) would contribute less to global warming than a refrigerant with higher GWP, if leaked to the atmosphere. This appliance contains a refrigerant fluid with a GWP equal to 550. This means that if 1 kg of this refrigerant fluid would be leaked to the atmosphere, the impact on global warming would be 550 times higher than 1 kg of CO₂, over a period of 100 years. Never try to interfere with the refrigerant circuit yourself or disassemble the product yourself and always ask a professional. The GWP of R32 is 675 in the IPCC 4th Assessment Report.

*2 Energy consumption based on standard test results. Actual energy consumption will depend on how the appliance is used and where it is located.

*3 Optional air protection guide is required where ambient temperature is lower than -5°C.

SERIES SELECTION

Power Inverter Series



Indoor Unit

R32

R410A



PKA-M35/50HA(L)



PKA-M60/71/100KA(L)

Outdoor Unit

R410A

For Single



PUHZ-ZRP35/50



PUHZ-ZRP60/71



PUHZ-ZRP100

R410A

For Multi
(Twin/Triple/Quadruple)



PUHZ-ZRP71



PUHZ-ZRP100/125/140/200/250

Remote Controller



Optional (*)



Optional



Optional (*)



Standard Inverter Series



Indoor Unit

R32

R410A



PKA-M35/50HA(L)



PKA-M60/71/100KA(L)

Outdoor Unit

R410A

For Single



PUHZ-P100

R410A

For Multi
(Twin/Triple/Quadruple)



PUHZ-P100/125/140



PUHZ-P200/250

Remote Controller



Optional (*)



Optional



Optional (*)



(*) PAC-SH29TC-E is required (optional)

PKA-M HA/KA Indoor Unit Combinations Indoor unit combinations shown below are possible.

Indoor Unit Combination	Outdoor Unit Capacity																			
	For Single									For Twin						For Triple			For Quadruple	
	35	50	60	71	100	125	140	200	250	71	100	125	140	200	250	140	200	250	200	250
Power Inverter (PUHZ-ZRP)	35x1	50x1	60x1	71x1	100x1	-	-	-	-	35x2	50x2	60x2	71x2	100x2	-	50x3	60x3	71x3	50x4	60x4
Distribution Pipe	-	-	-	-	-	-	-	-	-	MSDD-50TR-E			MSDD-60WR-E			MSDT-111R-E			MSDF-1111R-E	
Standard Inverter (PUHZ-P)	-	-	-	-	100x1	-	-	-	-	-	50x2	60x2	71x2	100x2	-	50x3	60x3	71x3	50x4	60x4
Distribution Pipe	-	-	-	-	-	-	-	-	-	MSDD-50TR-E			MSDD-60WR-E			MSDT-111R-E			MSDF-1111R-E	

PKA-M SERIES

POWER INVERTER



Type			Inverter Heat Pump							
Indoor Unit			PKA-M35HA(L)	PKA-M50HA(L)	PKA-M60KA(L)	PKA-M71KA(L)	PKA-M100KA(L)			
Outdoor Unit			PUHZ-ZRP35VKA2	PUHZ-ZRP50VKA2	PUHZ-ZRP60VHA2	PUHZ-ZRP71VHA2	PUHZ-ZRP100VKA3	PUHZ-ZRP100YKA3		
Refrigerant			R410A*1							
Power Supply			Outdoor power supply							
Outdoor (V/Phase/Hz)			VKA · VHA:230 / Single / 50, YKA:400 / Three / 50							
Cooling	Capacity	Rated	kW	3.6	4.6	6.1	7.1	9.5	9.5	
		Min - Max	kW	1.6 - 4.5	2.3 - 5.6	2.7 - 6.7	3.3 - 8.1	4.9 - 11.4	4.9 - 11.4	
	Total Input	Rated	kW	0.94	1.41	1.60	1.80	2.40	2.40	
		EER		3.83	3.26	3.81	3.94	3.96	3.96	
	Design Load		kW	3.6	4.6	6.1	7.1	9.5	9.5	
		Annual Electricity Consumption*2	kWh/a	214	296	324	368	522	533	
	SEER			5.9	5.4	6.5	6.7	6.3	6.2	
		Energy Efficiency Class		A+	A	A++	A++	A++	A++	
	Heating (Average Season)	Capacity	Rated	kW	4.1	5.0	7.0	8.0	11.2	11.2
			Min - Max	kW	1.6 - 5.2	2.5 - 7.3	2.8 - 8.2	3.5 - 10.2	4.5 - 14.0	4.5 - 14.0
Total Input		Rated	kW	1.07	1.50	1.96	2.19	3.04	3.04	
		COP		3.83	3.33	3.57	3.65	3.68	3.68	
Design Load			kW	2.4	3.3	4.4	4.7	7.8	7.8	
		Declared Capacity	kW	2.4 (-10°C)	3.3 (-10°C)	4.4 (-10°C)	4.7 (-10°C)	7.8 (-10°C)	7.8 (-10°C)	
Back Up Heating Capacity		at reference design temperature	kW	2.4 (-10°C)	3.3 (-10°C)	4.4 (-10°C)	4.7 (-10°C)	7.8 (-10°C)	7.8 (-10°C)	
		at operation limit temperature	kW	2.2 (-11°C)	3.2 (-11°C)	2.8 (-20°C)	3.5 (-20°C)	5.8 (-20°C)	5.8 (-20°C)	
Annual Electricity Consumption*2			kWh/a	847	1160	1473	1532	2608	2608	
		SCOP		3.9	4.0	4.2	4.3	4.1	4.1	
Operating Current (max)		A	13.4	13.4	19.4	19.4	27.1	8.6		
	Input	Rated	kW	0.04	0.04	0.06	0.06	0.08		
Outdoor Unit	Dimensions <Panel>	H x W x D	mm	295 - 898 - 249	13	21	21	365 - 1170 - 295	0.57	
		Weight <Panel>	kg	13	13	21	21	21		
	Air Volume [Lo-Mid-Hi]	Cooling	m³/min	9 - 10.5 - 12	9 - 10.5 - 12	18 - 20 - 22	18 - 20 - 22	20 - 23 - 26	20 - 23 - 26	
		Heating	m³/min	45	45	55	55	110	110	
	Sound Level (SPL)	Cooling	dB(A)	36 - 40 - 43	36 - 40 - 43	39 - 42 - 45	39 - 42 - 45	41 - 45 - 49	41 - 45 - 49	
		Heating	dB(A)	44	44	47	47	49	49	
	Sound Level (PWL)	Cooling	dB(A)	60	60	64	64	65	65	
		Heating	dB(A)	46	46	48	48	51	51	
	Operating Current (max)	Cooling	A	13.0	13.0	19.0	19.0	26.5	8.0	
		Heating	A	16	16	25	25	32	16	
Ext. Piping	Diameter	Liquid / Gas	mm	6.35 / 12.7	6.35 / 12.7	9.52 / 15.88	9.52 / 15.88	9.52 / 15.88	9.52 / 15.88	
	Max. Length	Out-In	m	50	50	50	50	75		
	Max. Height	Out-In	m	30	30	30	30	30		
Guaranteed Operating Range [Outdoor]	Cooling*3	°C	-15 ~ +46	-15 ~ +46	-15 ~ +46	-15 ~ +46	-15 ~ +46	-15 ~ +46		
	Heating	°C	-11 ~ +21	-11 ~ +21	-20 ~ +21	-20 ~ +21	-20 ~ +21	-20 ~ +21		

*1 Refrigerant leakage contributes to climate change. Refrigerant with lower global warming potential (GWP) would contribute less to global warming than a refrigerant with higher GWP, if leaked to the atmosphere. This appliance contains a refrigerant fluid with a GWP equal to 1975. This means that if 1 kg of this refrigerant fluid would be leaked to the atmosphere, the impact on global warming would be 1975 times higher than 1 kg of CO₂, over a period of 100 years. Never try to interfere with the refrigerant circuit yourself or disassemble the product yourself and always ask a professional.
The GWP of R410A is 2088 in the IPCC 4th Assessment Report.
*2 Energy consumption based on standard test results. Actual energy consumption will depend on how the appliance is used and where it is located.
*3 Optional air protection guide is required where ambient temperature is lower than -5°C.

PKA-M SERIES

STANDARD INVERTER



Type			Inverter Heat Pump							
Indoor Unit			PKA-M100KA(L)							
Outdoor Unit			PUHZ-P100VKA	PUHZ-P100YKA			PUHZ-P100YKA			
Refrigerant			R410A*1							
Power Supply			Outdoor power supply							
Outdoor (V/Phase/Hz)			230 / Single / 50							
Cooling	Capacity	Rated	kW	9.4			9.4			
		Min - Max	kW	3.7 - 10.6			3.7 - 10.6			
	Total Input	Rated	kW	3.12			3.12			
		EER		3.01			3.01			
	Design Load		kW	9.4			9.4			
		Annual Electricity Consumption*2	kWh/a	586			586			
	SEER			5.6			5.6			
		Energy Efficiency Class		A+			A+			
	Heating (Average Season)	Capacity	Rated	kW	11.2			11.2		
			Min - Max	kW	2.8 - 12.5			2.8 - 12.5		
Total Input		Rated	kW	3.48			3.48			
		COP		3.21			3.21			
Design Load			kW	8.0			8.0			
		Declared Capacity	kW	6.0 (-10°C)			6.0 (-10°C)			
Back Up Heating Capacity		at reference design temperature	kW	7.0 (-7°C)			7.0 (-7°C)			
		at operation limit temperature	kW	4.5 (-15°C)			4.5 (-15°C)			
Annual Electricity Consumption*2			kWh/a	2.0			2.0			
		SCOP		4.0			4.0			
Operating Current (max)		A	20.6			12.1				
	Input	Rated	kW	0.08			0.08			
Outdoor Unit	Dimensions <Panel>	H x W x D	mm	0.57			0.57			
		Weight <Panel>	kg	21			21			
	Air Volume [Lo-Mid-Hi]	Cooling	m³/min	20 - 23 - 26			20 - 23 - 26			
		Heating	m³/min	79			79			
	Sound Level (SPL)	Cooling	dB(A)	41 - 45 - 49			41 - 45 - 49			
		Heating	dB(A)	51			51			
	Sound Level (PWL)	Cooling	dB(A)	65			65			
		Heating	dB(A)	54			54			
	Operating Current (max)	Cooling	A	20.0			11.5			
		Heating	A	32			16			
Ext. Piping	Diameter	Liquid / Gas	mm	9.52 / 15.88			9.52 / 15.88			
	Max. Length	Out-In	m	50			50			
	Max. Height	Out-In	m	30			30			
Guaranteed Operating Range [Outdoor]	Cooling*3	°C	-15 ~ +46			-15 ~ +46				
	Heating	°C	-15 ~ +21			-15 ~ +21				

*1 Refrigerant leakage contributes to climate change. Refrigerant with lower global warming potential (GWP) would contribute less to global warming than a refrigerant with higher GWP, if leaked to the atmosphere. This appliance contains a refrigerant fluid with a GWP equal to 1975. This means that if 1 kg of this refrigerant fluid would be leaked to the atmosphere, the impact on global warming would be 1975 times higher than 1 kg of CO₂, over a period of 100 years. Never try to interfere with the refrigerant circuit yourself or disassemble the product yourself and always ask a professional.
The GWP of R410A is 2088 in the IPCC 4th Assessment Report.
*2 Energy consumption based on standard test results. Actual energy consumption will depend on how the appliance is used and where it is located.
*3 Optional air protection guide is required where ambient temperature is lower than -5°C.

PCA-KA SERIES



PCA-M35/50/60/71/100/125/140KA



A stylish new indoor unit design and airflow settings for both high- and low-ceiling interiors expand installation possibilities. Together with exceptional energy-saving performance, these units are the solution to diversified air conditioning needs.

Stylish Indoor Unit Design

A stylish square-like design is adopted for the indoor units of all models. As a result, the units blend in better with the ceiling.



PCA-KA

ErP Lot 10 Compliant with High Energy-efficiency Achieving SEER/SCOP Rank A, A+ and A++

A direct-current (DC) fan motor is installed in the indoor unit, increasing the seasonal energy efficiency of newly designed Power Inverter series (PUHZ-ZM) and resulting in the full capacity models comply ErP Lot 10 with energy ranking A+/A++ for cooling and A/A+ for heating. This contribute to an impressive reduction in the cost of annual electricity.

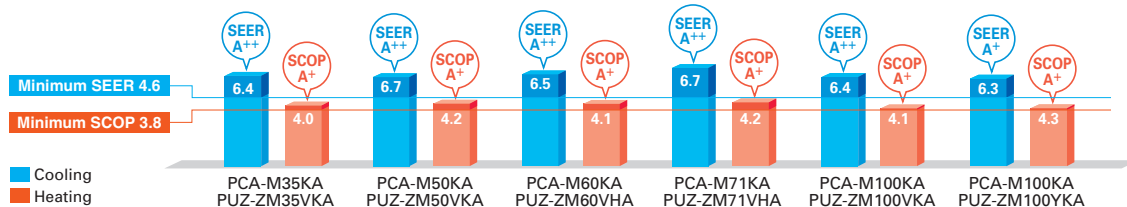

Optional Drain Pump for Full-capacity Models

The pumping height of the optional drain pump has been increased from 400mm to 600mm, expanding flexibility in choosing unit location during installation work.

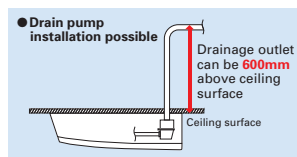

Outside-air Intake

Units are equipped with a knock-out hole that enables the induction of fresh outside-air.

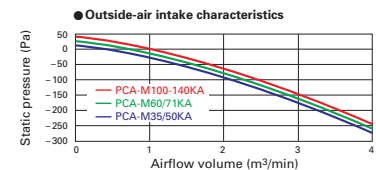

Equipped with Automatic Air-speed Adjustment

In addition to the conventional 4-speed setting, units are now equipped with an automatic air-speed adjustment mode. This setting automatically adjusts the air-speed to conditions that match the room environment. At the start of heating/cooling operation, the airflow is set to high-speed to quickly heat/cool the room. When the room temperature reaches the desired setting, the airflow speed is decreased automatically for stable comfortable heating/cooling operation.

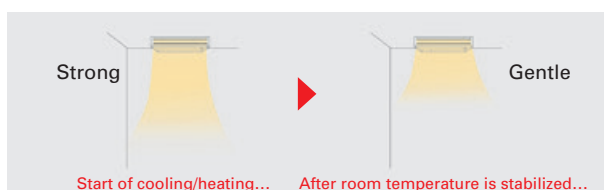

Equipped with High- /Low-ceiling Modes

Units are equipped with high- and low-ceiling operation modes that make it possible to switch the airflow volume to match room height. The ability to choose the optimum airflow volume makes it possible to optimize the breezy sensation felt throughout the room.

Capacity	High ceiling	Standard ceiling	Low ceiling
35	3.5m	2.7m	2.5m
50	3.5m	2.7m	2.5m
60	3.5m	2.7m	2.5m
71	3.5m	2.7m	2.5m
100	4.2m	3.0m	2.6m
125	4.2m	3.0m	2.6m
140	4.2m	3.0m	2.6m

PCA-HA SERIES

R410A

PCA-RP71HAQ



Standard features include a strong carbon-black stainless steel body and built-in oil mist filter to prevent oil from getting into the unit providing a comfortable air conditioning environment in kitchens that use open-flame cooking.

Tough on Oily Smoke

A durable stainless steel casing that is resistant to oil and grease is provided to protect the surface of the body. Grimy dirt and stains are removed easily, enabling the unit to be kept clean at all times.

High-performance Oil Mist Filter

A high-performance heavy-duty oil mist filter is included as standard equipment. The filtering system is more efficient than conventional filters, thereby effectively reducing the oily smoke entering the air conditioner. The filter is disposable, thereby enabling trouble-free cleaning and maintenance.

Oil Mist Filter Cleaning

When used in kitchens, the oil mist filter should be replaced once every two months. The system comes with 12 filter elements. After these have been used, optional elements (PAC-SG38KF-E) can be purchased.

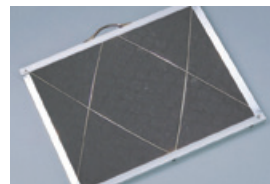

Oil mist filter

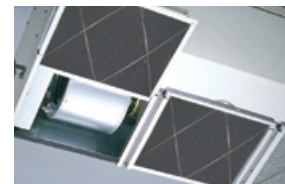

Pull the handle to easily slide the filter out

Easy Maintenance – Even for Cleaning the Fan

A separate fan casing that can be disassembled in sections is adopted to ensure easy fan cleaning. Drain pan cleaning onsite is also no problem owing to the use of a pipe connector that is easily removed.



Cosmetic Front and Hanging Fixture Covers (Option)

Cosmetic covers are available to prevent the collection of dust and grime on the main body and hanging fixture sections.

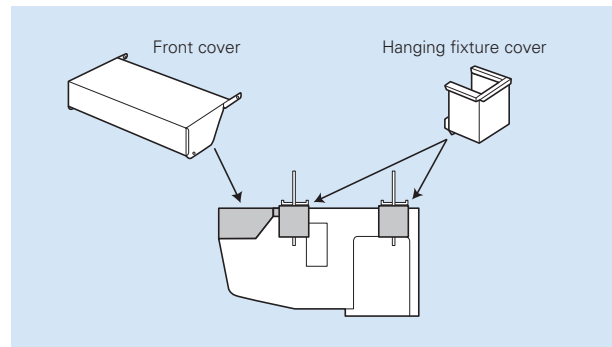

Fresh Outside-air Intake (Option)

There is a knock-out opening on the rear panel of the unit that can be used to bring fresh air into the unit. This helps to improve ventilation and make the kitchen comfortable.

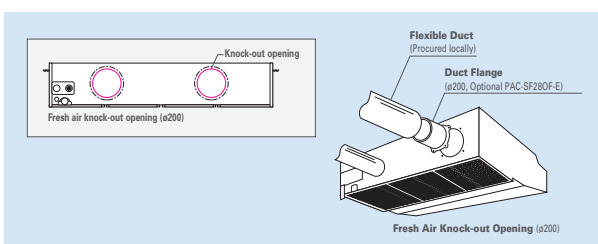

- Notes: 1) A fresh-air duct flange is required (sold separately)
2) Intake air is not 100% fresh (outside) air.

SERIES SELECTION

Power Inverter Series



Indoor Unit

R32
R410A



PCA-M35/50/60/71/100/125/140KA

Outdoor Unit

R32

For Single



PUZ-ZM35/50 PUZ-ZM60/71 PUZ-ZM100/125/140

R32

For Multi
(Twin/Triple)



PUZ-ZM71 PUZ-ZM100/125/140

Remote Controller



Optional



Optional



Optional



Optional

PCZ-M KA Indoor Unit Combinations Indoor unit combinations shown below are possible.

Indoor Unit Combination	Outdoor Unit Capacity																			
	For Single									For Twin						For Triple			For Quadruple	
	35	50	60	71	100	125	140	200	250	71	100	125	140	200	250	140	200	250	200	250
Power Inverter (PUZ-ZM)	35x1	50x1	60x1	71x1	100x1	125x1	140x1	-	-	35x2	50x2	60x2	71x2	-	-	50x3	-	-	-	-
Distribution Pipe	-	-	-	-	-	-	-	-	-	MSDD-50TR2-E						-	MSDT-111R2-E			-

SERIES SELECTION

Standard Inverter Series



Indoor Unit

R32
R410A



PCA-M35/50/60/71/100/125/140KA

Outdoor Unit

R32

For Single

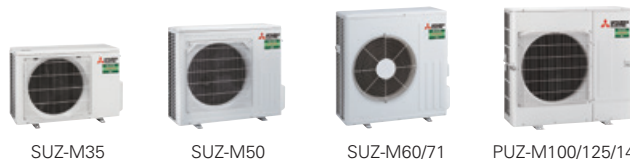

SUZ-M35 SUZ-M50 SUZ-M60/71 PUZ-M100/125/140

R32

For Multi
(Twin/Triple)



PUZ-M100/125/140

Remote Controller



Optional



Optional



Optional



Optional

PCZ-M KA Indoor Unit Combinations Indoor unit combinations shown below are possible.

Indoor Unit Combination	Outdoor Unit Capacity																			
	For Single									For Twin						For Triple			For Quadruple	
	35	50	60	71	100	125	140	200	250	71	100	125	140	200	250	140	200	250	200	250
Standard Inverter (SUZ-M & PUZ-M)	35x1	50x1	60x1	71x1	100x1	125x1	140x1	-	-	50x2	60x2	71x2	-	-	50x3	-	-	-	-	
Distribution Pipe	-	-	-	-	-	-	-	-	-	MSDD-50TR2-E						-	MSDT-111R2-E			-

PCA-M KA SERIES

POWER INVERTER



Type	Inverter Heat Pump												
Indoor Unit	PCA-M35KA	PCA-M50KA	PCA-M60KA	PCA-M71KA	PCA-M100KA		PCA-M125KA		PCA-M140KA				
Outdoor Unit	PUZ-ZM35VKA	PUZ-ZM50VKA	PUZ-ZM60VHA	PUZ-ZM71VHA	PUZ-ZM100VKA	PUZ-ZM100YKA	PUZ-ZM125VKA	PUZ-ZM125YKA	PUZ-ZM140VKA	PUZ-ZM140YKA			
Refrigerant	R32*1												
Power Supply	Outdoor power supply VKA · VHA:230 / Single / 50, YKA:400 / Three / 50												
Cooling	Capacity	Rated	kW										
		Min - Max	kW										
	Total Input	Rated	kW										
	EER												
	EEL Rank												
	Design Load		kW										
	Annual Electricity Consumption*2		kWh/a										
	SEER												
	Energy Efficiency Class												
	Heating (Average Season)	Capacity	Rated	kW									
		Min - Max	kW										
Total Input		Rated	kW										
COP													
EEL Rank													
Design Load			kW										
Declared Capacity		at reference design temperature	kW										
		at bivalent temperature	kW										
		at operation limit temperature	kW										
Back Up Heating Capacity			kW										
Annual Electricity Consumption*2		kWh/a											
SCOP													
Energy Efficiency Class													
Operating Current (max)	Input	Rated	A										
	Operating Current (max)		A										
	Dimensions <Panel>	H × W × D	mm										
	Weight <Panel>		kg										
	Air Volume [Lo-Mi2-Mi1-Hi]		m ³ /min										
	Sound Level (SPL) [Lo-Mi2-Mi1-Hi]		dB(A)										
	Sound Level (PWL)		dB(A)										
	Dimensions	H × W × D	mm										
	Weight		kg										
	Air Volume	Cooling	m ³ /min										
	Heating	m ³ /min											
Sound Level (SPL)	Cooling	dB(A)											
	Heating	dB(A)											
Sound Level (PWL)	Cooling	dB(A)											
	Heating	dB(A)											
Operating Current (max)		A											
Breaker Size		A											
Ext. Piping	Diameter	Liquid / Gas	mm										
	Max. Length	Out-In	m										
	Max. Height	Out-In	m										
Guaranteed Operating Range [Outdoor]	Cooling*3		°C										
	Heating		°C										

*1 Refrigerant leakage contributes to climate change. Refrigerant with lower global warming potential (GWP) would contribute less to global warming than a refrigerant with higher GWP if leaked to the atmosphere. This appliance contains a refrigerant fluid with a GWP equal to 550. This means that if 1 kg of this refrigerant fluid would be leaked to the atmosphere, the impact on global warming would be 550 times higher than 1 kg of CO₂ over a period of 100 years. Never try to interfere with the refrigerant circuit yourself or disassemble the product yourself and always ask a professional. The GWP of R32 is 675 in the IPCC 4th Assessment Report.
 *2 Energy consumption based on standard test results. Actual energy consumption will depend on how the appliance is used and where it is located.
 *3 Optional arc protection guide is required where ambient temperature is lower than -5°C.

PCA-M KA SERIES

STANDARD INVERTER



Type	Inverter Heat Pump												
Indoor Unit	PCA-M35KA	PCA-M50KA	PCA-M60KA	PCA-M71KA	PCA-M100KA		PCA-M125KA		PCA-M140KA				
Outdoor Unit	SUZ-M35VA	SUZ-M50VA	SUZ-M60VA	SUZ-M71VA	PUZ-M100VKA	PUZ-M100YKA	PUZ-M125VKA	PUZ-M125YKA	PUZ-M140VKA	PUZ-M140YKA			
Refrigerant	R32*1												
Power Supply	Outdoor power supply VA · VKA:230 / Single / 50, YKA:400 / Three / 50												
Cooling	Capacity	Rated	kW										
		Min - Max	kW										
	Total Input	Rated	kW										
	EER												
	EEL Rank												
	Design Load		kW										
	Annual Electricity Consumption*2		kWh/a										
	SEER												
	Energy Efficiency Class												
	Heating (Average Season)	Capacity	Rated	kW									
		Min - Max	kW										
Total Input		Rated	kW										
COP													
EEL Rank													
Design Load			kW										
Declared Capacity		at reference design temperature	kW										
		at bivalent temperature	kW										
		at operation limit temperature	kW										
Back Up Heating Capacity			kW										
Annual Electricity Consumption*2		kWh/a											
SCOP													
Energy Efficiency Class													
Operating Current (max)	Input	Rated	A										
	Operating Current (max)		A										
	Dimensions <Panel>	H × W × D	mm										
	Weight <Panel>		kg										
	Air Volume [Lo-Mi2-Mi1-Hi]		m ³ /min										
	Sound Level (SPL) [Lo-Mi2-Mi1-Hi]		dB(A)										
	Sound Level (PWL)		dB(A)										
	Dimensions	H × W × D	mm										
	Weight		kg										
	Air Volume	Cooling	m ³ /min										
	Heating	m ³ /min											
Sound Level (SPL)	Cooling	dB(A)											
	Heating	dB(A)											
Sound Level (PWL)	Cooling	dB(A)											
	Heating	dB(A)											
Operating Current (max)		A											
Breaker Size		A											
Ext. Piping	Diameter	Liquid / Gas	mm										
	Max. Length	Out-In	m										
	Max. Height	Out-In	m										
Guaranteed Operating Range [Outdoor]	Cooling*3		°C										
	Heating		°C										

*1 Refrigerant leakage contributes to climate change. Refrigerant with lower global warming potential (GWP) would contribute less to global warming than a refrigerant with higher GWP if leaked to the atmosphere. This appliance contains a refrigerant fluid with a GWP equal to 550. This means that if 1 kg of this refrigerant fluid would be leaked to the atmosphere, the impact on global warming would be 550 times higher than 1 kg of CO₂ over a period of 100 years. Never try to interfere with the refrigerant circuit yourself or disassemble the product yourself and always ask a professional. The GWP of R32 is 675 in the IPCC 4th Assessment Report.
 *2 Energy consumption based on standard test results. Actual energy consumption will depend on how the appliance is used and where it is located.
 *3 Optional arc protection guide is required where ambient temperature is lower than -5°C.

SERIES SELECTION

Power Inverter Series



Indoor Unit

R32
R410A



PCA-M35/50/60/71/100/125/140KA

Outdoor Unit

R410A

For Single



PUHZ-ZRP35/50 PUHZ-ZRP60/71 PUHZ-ZRP100/125/140

R410A

For Multi
(Twin/Triple/Quadruple)



PUHZ-ZRP100/125/140/200/250

Remote Controller



Optional Optional Optional Optional

Standard Inverter Series



Indoor Unit

R32
R410A



PCA-M35/50/60/71/100/125/140KA

Outdoor Unit

R410A

For Single



SUZ-KA35 SUZ-KA50/60/71 PUHZ-P100/125/140

R410A

For Multi
(Twin/Triple/Quadruple)



PUHZ-P100/125/140 PUHZ-P200/250

Remote Controller



Optional Optional Optional Optional

PCA-M KA Indoor Unit Combinations Indoor unit combinations shown below are possible.

Indoor Unit Combination	Outdoor Unit Capacity																			
	For Single									For Twin						For Triple			For Quadruple	
	35	50	60	71	100	125	140	200	250	71	100	125	140	200	250	140	200	250	200	250
Power Inverter (PUHZ-ZRP)	35x1	50x1	60x1	71x1	100x1	125x1	140x1	-	-	35x2	50x2	60x2	71x2	100x2	125x2	50x3	60x3	71x3	50x4	60x4
Distribution Pipe	-	-	-	-	-	-	-	-	-	-	-	-	-	MSDD-50TR-E	MSDD-50WR-E	MSDT-111R-E	-	-	MSDF-1111R-E	-
Standard Inverter (PUHZ-P&SUZ)	35x1	50x1	60x1	71x1	100x1	125x1	140x1	-	-	50x2	60x2	71x2	100x2	125x2	50x3	60x3	71x3	50x4	60x4	
Distribution Pipe	-	-	-	-	-	-	-	-	-	-	-	-	-	MSDD-50TR-E	MSDD-50WR-E	MSDT-111R-E	-	-	MSDF-1111R-E	-

SERIES SELECTION

Power Inverter Series



Indoor Unit

R410A



PCA-RP71HAQ

Outdoor Unit

R410A

For Single



PUHZ-ZRP71

R410A

For Multi
(Twin/Triple)



PUHZ-ZRP140/250

Remote Controller



Optional Optional Optional

PCA-RP HA Indoor Unit Combinations Indoor unit combinations shown below are possible.

Indoor Unit Combination	Outdoor Unit Capacity																			
	For Single									For Twin						For Triple			For Quadruple	
	35	50	60	71	100	125	140	200	250	71	100	125	140	200	250	140	200	250	200	250
Power Inverter (PUHZ-ZRP)	-	-	-	71x1	-	-	-	-	-	-	-	-	71x2	-	-	-	-	71x3	-	-
Distribution Pipe	-	-	-	-	-	-	-	-	-	-	-	-	MSDD-50TR-E	-	-	-	-	MSDT-111R-E	-	-

PCA-M KA SERIES

POWER INVERTER



Type		Inverter Heat Pump												
Indoor Unit		PCA-M35KA	PCA-M50KA	PCA-M60KA	PCA-M71KA	PCA-M100KA		PCA-M125KA		PCA-M140KA		PCA-M140KA		
Outdoor Unit		PUHZ-ZRP35VKA2	PUHZ-ZRP50VKA2	PUHZ-ZRP60VHA2	PUHZ-ZRP71VHA2	PUHZ-ZRP100VKA3	PUHZ-ZRP100YKA3	PUHZ-ZRP125VKA3	PUHZ-ZRP125YKA3	PUHZ-ZRP140VKA3	PUHZ-ZRP140YKA3			
Refrigerant		R410A*1												
Power Supply		Outdoor power supply VKA·VHA·230 / Single / 50, YKA·400 / Three / 50												
Cooling	Capacity	Rated	kW	3.6	5.0	6.1	7.1	9.5	9.5	12.5	12.5	13.4	13.4	
		Min - Max	kW	1.6 - 4.5	2.3 - 5.6	2.7 - 6.7	3.3 - 8.1	4.9 - 11.4	4.9 - 11.4	5.5 - 14.0	5.5 - 14.0	6.2 - 15.0	6.2 - 15.0	
	Total Input	Rated	kW	0.86	1.34	1.66	1.82	2.42	2.42	3.98	3.98	3.95	3.95	
	EER			4.19	3.73	3.67	3.90	3.93	3.93	3.14	3.14	3.39	3.39	
Heating (Average Season)	Capacity	Rated	kW	4.1	5.5	7.0	8.0	11.2	11.2	14.0	14.0	16.0	16.0	
		Min - Max	kW	1.6 - 5.2	2.5 - 6.6	2.8 - 8.2	3.5 - 10.2	4.5 - 14.0	4.5 - 14.0	5.0 - 16.0	5.0 - 16.0	5.7 - 18.0	5.7 - 18.0	
	Total Input	Rated	kW	1.02	1.45	1.93	2.20	3.04	3.80	3.80	4.57	4.57		
	COP			4.02	3.79	3.63	3.64	3.68	3.68	3.68	3.68	3.50	3.50	
Operating Current (max)	Indoor Unit	Input	Rated	A	13.3	13.4	19.4	19.4	27.2	8.7	27.3	10.3	28.9	
	Outdoor Unit	Input	Rated	kW	0.04	0.05	0.06	0.06	0.09	0.09	0.11	0.14	0.14	
Ext. Piping	Max. Length	Out-In	m	50	50	50	50	75	75	75	75	75		
	Max. Height	Out-In	m	30	30	30	30	30	30	30	30	30		
	Guaranteed Operating Range [Outdoor]	Cooling*3	°C	-15 ~ +46	-15 ~ +46	-15 ~ +46	-15 ~ +46	-15 ~ +46	-15 ~ +46	-15 ~ +46	-15 ~ +46	-15 ~ +46		
		Heating	°C	-11 ~ +21	-11 ~ +21	-20 ~ +21	-20 ~ +21	-20 ~ +21	-20 ~ +21	-20 ~ +21	-20 ~ +21	-20 ~ +21		

*1 Refrigerant leakage contributes to climate change. Refrigerant with lower global warming potential (GWP) would contribute less to global warming than a refrigerant with higher GWP, if leaked to the atmosphere. This appliance contains a refrigerant fluid with a GWP equal to 1975. This means that if 1 kg of this refrigerant fluid would be leaked to the atmosphere, the impact on global warming would be 1975 times higher than 1 kg of CO₂, over a period of 100 years. Never try to interfere with the refrigerant circuit yourself or disassemble the product yourself and always ask a professional.
The GWP of R410A is 2088 in the IPCC 4th Assessment Report.
*2 Energy consumption based on standard test results. Actual energy consumption will depend on how the appliance is used and where it is located.
*3 Optional air protection guide is required where ambient temperature is lower than -5°C.

PCA-M KA SERIES

STANDARD INVERTER



Type		Inverter Heat Pump												
Indoor Unit		PCA-M35KA	PCA-M50KA	PCA-M60KA	PCA-M71KA	PCA-M100KA	PCA-M125KA	PCA-M140KA		PCA-M140KA		PCA-M140KA		
Outdoor Unit		SUZ-KA35VA6	SUZ-KA50VA6	SUZ-KA60VA6	SUZ-KA71VA6	PUHZ-P100YKA	PUHZ-P100YKA	PUHZ-P125YKA	PUHZ-P125YKA	PUHZ-P140YKA	PUHZ-P140YKA			
Refrigerant		R410A*1												
Power Supply		Outdoor power supply VA·VKA·230 / Single / 50, YKA·400 / Three / 50												
Cooling	Capacity	Rated	kW	3.6	5.0	5.7	7.1	9.4	9.4	12.1	12.1	13.6	13.6	
		Min - Max	kW	1.4 - 3.9	2.3 - 5.6	2.3 - 6.3	2.8 - 8.1	3.7 - 10.6	3.7 - 10.6	5.6 - 13.0	5.6 - 13.0	5.8 - 14.1	5.8 - 14.1	
	Total Input	Rated	kW	1.050	1.550	1.720	2.060	3.05	3.05	4.24	4.24	5.62	5.62	
	EER			3.43	3.23	3.31	3.45	3.08	3.08	2.85	2.85	2.41	2.41	
Heating (Average Season)	Capacity	Rated	kW	4.1	5.5	6.9	7.9	11.2	11.2	13.5	13.5	15.0	15.0	
		Min - Max	kW	1.7 - 5.0	1.7 - 6.6	2.5 - 8.0	2.6 - 10.2	2.8 - 12.5	2.8 - 12.5	4.8 - 15.0	4.8 - 15.0	4.9 - 15.8	4.9 - 15.8	
	Total Input	Rated	kW	1.050	1.520	1.910	2.180	3.37	3.37	4.06	4.06	4.47	4.47	
	COP			3.90	3.62	3.61	3.62	3.32	3.32	3.32	3.32	3.35	3.35	
Operating Current (max)	Indoor Unit	Input	Rated	A	8.5	12.4	14.4	16.5	20.7	12.2	27.3	12.3	30.9	
	Outdoor Unit	Input	Rated	kW	0.04	0.05	0.06	0.06	0.09	0.09	0.11	0.11	0.14	
Ext. Piping	Max. Length	Out-In	m	20	30	30	30	50	50	50	50	50		
	Max. Height	Out-In	m	12	30	30	30	30	30	30	30	30		
	Guaranteed Operating Range [Outdoor]	Cooling*3	°C	-10 ~ +46	-15 ~ +46	-15 ~ +46	-15 ~ +46	-15 ~ +46	-15 ~ +46	-15 ~ +46	-15 ~ +46	-15 ~ +46		
		Heating	°C	-10 ~ +24	-10 ~ +24	-10 ~ +24	-10 ~ +24	-15 ~ +21	-15 ~ +21	-15 ~ +21	-15 ~ +21	-15 ~ +21		

*1 Refrigerant leakage contributes to climate change. Refrigerant with lower global warming potential (GWP) would contribute less to global warming than a refrigerant with higher GWP, if leaked to the atmosphere. This appliance contains a refrigerant fluid with a GWP equal to 1975. This means that if 1 kg of this refrigerant fluid would be leaked to the atmosphere, the impact on global warming would be 1975 times higher than 1 kg of CO₂, over a period of 100 years. Never try to interfere with the refrigerant circuit yourself or disassemble the product yourself and always ask a professional.
The GWP of R410A is 2088 in the IPCC 4th Assessment Report.
*2 Energy consumption based on standard test results. Actual energy consumption will depend on how the appliance is used and where it is located.
*3 Optional air protection guide is required where ambient temperature is lower than -5°C.

PCA-RP HA SERIES

POWER INVERTER

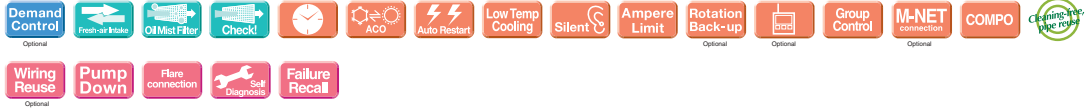

Type			Inverter Heat Pump	
Indoor Unit			PCA-RP71HAQ	
Outdoor Unit			PUHZ-ZRP71VHA2	
Refrigerant			R410A*1	
Power Supply	Source		Outdoor power supply	
	Outdoor (V/Phase/Hz)		230 / Single / 50	
Cooling	Capacity	Rated	kW	
		Min - Max	7.1	
			3.3 - 8.1	
	Total Input	Rated	kW	
			2.17	
	EER			
			-	
		EEL Rank		
			-	
	Design Load		kW	
			7.1	
	Annual Electricity Consumption*2		kWh/a	
			447	
	SEER			
			5.6	
			A+	
			Energy Efficiency Class	
Heating (Average Season)	Capacity	Rated	kW	
		Min - Max	7.6	
			3.5 - 10.2	
	Total Input	Rated	kW	
			2.35	
	COP			
			-	
		EEL Rank		
				-
		Design Load		kW
				4.7
		Declared Capacity	at reference design temperature	kW
			4.7 (-10°C)	
		at bivalent temperature	kW	
			4.7 (-10°C)	
		at operation limit temperature	kW	
			3.5 (-20°C)	
	Back Up Heating Capacity		kW	
			0	
	Annual Electricity Consumption*2		kWh/a	
			1751	
	SCOP			
			3.8	
			Energy Efficiency Class	
			A	
Operating Current (max)			A	
			19.4	
Indoor Unit	Input	Rated	kW	
			0.09	
	Operating Current (max)		A	
			0.43	
	Dimensions <Panel>	H x W x D	mm	
			280 - 1136 - 650	
	Weight <Panel>		kg	
			41	
Air Volume [Lo-Hi]		m ³ /min		
		17 - 19		
Sound Level (SPL) [Lo-Hi]		dB(A)		
		34 - 38		
Sound Level (PWL)		dB(A)		
		56		
Outdoor Unit	Dimensions	H x W x D	mm	
			943 - 950 - 330 (+30)	
	Weight		kg	
			70	
	Air Volume	Cooling	m ³ /min	
			55.0	
		Heating	m ³ /min	
			55.0	
	Sound Level (SPL)	Cooling	dB(A)	
			47	
	Heating	dB(A)		
		48		
Sound Level (PWL)	Cooling	dB(A)		
		67		
Operating Current (max)		A		
		19.0		
Breaker Size		A		
		25		
Ext. Piping	Diameter	Liquid / Gas	mm	
			9.52 / 15.88	
	Max. Length	Out-In	m	
		50		
Max. Height	Out-In	m		
		30		
Guaranteed Operating Range [Outdoor]	Cooling*3	°C	-15 ~ +46	
	Heating	°C	-20 ~ +21	

*1 Refrigerant leakage contributes to climate change. Refrigerant with lower global warming potential (GWP) would contribute less to global warming than a refrigerant with higher GWP, if leaked to the atmosphere. This appliance contains a refrigerant fluid with a GWP equal to 1975. This means that if 1 kg of this refrigerant fluid would be leaked to the atmosphere, the impact on global warming would be 1975 times higher than 1 kg of CO₂, over a period of 100 years. Never try to interfere with the refrigerant circuit yourself or disassemble the product yourself and always ask a professional.
The GWP of R410A is 2088 in the IPCC 4th Assessment Report.

*2 Energy consumption based on standard test results. Actual energy consumption will depend on how the appliance is used and where it is located.

*3 Optional air protection guide is required where ambient temperature is lower than -5°C.

PSA SERIES R410A

Installation of this floor-standing series is easy and quick.
An excellent choice when there is a sudden need for an air conditioner to be installed.



Quick and Easy Installation, Space-saving and Design That Compliments Any Interior

The floor-standing indoor unit is mounted on the floor, enabling quick installation. Its compact body requires only minimal space.

● PSA-RP71KA

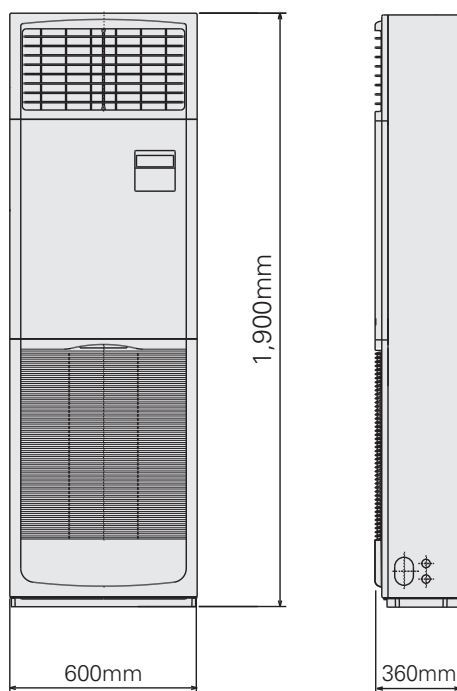

4-way pipe work connections enable greater freedom in installation

Remarkable freedom in choosing installation sites is allowed by providing piping connection to the indoor unit in four places: left side, back, from underneath and on the right side of the unit. Even installation in the corner of a room is easy.

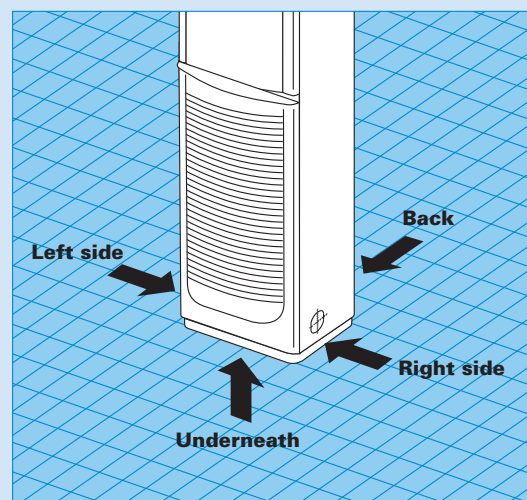

Built-in Remote Controller

Easy Operation with Built-in PAR-21MAA Remote Controller

Icon, letter and number visibility are improved with the adoption of a dot liquid-crystal display (LCD), and operation management functions have been increased.

Main Functions

- Multi-language Display
- Limited Temperature Range Setting
- Auto-off Timer
- Operation Lock
- Weekly Timer



SERIES SELECTION

Power Inverter Series



Indoor Unit

R410A



PSA-RP71/100/125/140KA

Outdoor Unit

R410A

For Single



PUHZ-ZRP71



PUHZ-ZRP100/125/140

R410A

For Multi
(Twin/Triple)



PUHZ-ZRP140/200/250

Remote Controller



Built-in

Standard Inverter Series



Indoor Unit

R410A



PSA-RP71/100/125/140KA

Outdoor Unit

R410A

For Single



PUHZ-P100/125/140

R410A

For Multi
(Twin/Triple)



PUHZ-P140



PUHZ-P200/250

Remote Controller



Built-in

PSZ-RP KA Indoor Unit Combinations Indoor unit combinations shown below are possible.

Indoor Unit Combination	Outdoor Unit Capacity																			
	For Single										For Twin					For Triple			For Quadruple	
	35	50	60	71	100	125	140	200	250	71	100	125	140	200	250	140	200	250	200	250
Power Inverter (PUHZ-ZRP)	-	-	-	71x1	100x1	125x1	140x1	-	-	-	-	-	71x2	100x2	125x2	-	-	71x3	-	-
Distribution Pipe	-	-	-	-	-	-	-	-	-	-	-	-	MSDD-80TR-E	MSDD-50WR-E	-	-	MSD111R-E	-	-	
Standard Inverter (PUHZ-P)	-	-	-	-	100x1	125x1	140x1	-	-	-	-	-	71x2	100x2	125x2	-	-	71x3	-	-
Distribution Pipe	-	-	-	-	-	-	-	-	-	-	-	-	MSDD-80TR-E	MSDD-50WR-E	-	-	MSD111R-E	-	-	

PSA-RP SERIES

POWER INVERTER

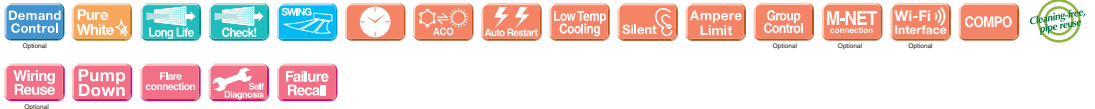

Type		Inverter Heat Pump								
Indoor Unit		PSA-RP71KA		PSA-RP100KA		PSA-RP125KA		PSA-RP140KA		
Outdoor Unit		PUHZ-ZRP71VHA2		PUHZ-ZRP100VKA3		PUHZ-ZRP125VKA3		PUHZ-ZRP140VKA3		
Refrigerant		R410A*1								
Power Supply		Outdoor power supply VKA · VHA:230 / Single / 50, YKA:400 / Three / 50								
Cooling	Capacity	Rated	7.1		9.5		12.5		13.4	
		Min - Max	3.3 - 8.1		4.9 - 11.4		4.9 - 11.4		5.5 - 14.0	
	Total Input	Rated	1.89		2.50		4.09		4.06	
	EER		-		-		3.06		3.06	
		EEL Rank	-		-		-		-	
	Design Load	kW	7.1		9.5		9.5		13.4	
	Annual Electricity Consumption*2	kWh/a	396		595		606		-	
	SEER		6.3		5.6		5.5		-	
		Energy Efficiency Class	A++		A+		A		-	
	Heating (Average Season)	Capacity	Rated	7.6		11.2		14.0		16.0
		Min - Max	3.5 - 10.2		4.5 - 14.0		4.5 - 14.0		5.0 - 16.0	
Total Input		Rated	2.21		3.08		4.24		4.79	
COP			-		-		3.30		3.30	
		EEL Rank	-		-		-		-	
Design Load		kW	4.7		7.8		7.8		11.2	
Declared Capacity		at reference design temperature	4.7 (-10°C)		7.8 (-10°C)		7.8 (-10°C)		11.2 (-10°C)	
		at bivalent temperature	4.7 (-10°C)		7.8 (-10°C)		7.8 (-10°C)		11.2 (-10°C)	
		at operation limit temperature	3.5 (-20°C)		5.8 (-20°C)		5.8 (-20°C)		8.5 (-20°C)	
Back Up Heating Capacity		kW	0		0		0		0	
Operating Current (max)	Input	Rated	19.4		27.2		27.2		28.7	
	Operating Current (max)	kW	0.06		0.11		0.11		0.11	
		A	0.4		0.71		0.73		0.73	
		Dimensions <Panel>	H x W x D		mm		1900 - 600 - 360		mm	
		Weight <Panel>	kg		46		46		48	
		Air Volume [Lo-Mid-Hi]	m³/min		20 - 22 - 24		25 - 28 - 30		25 - 28 - 31	
		Sound Level (SPL) [Lo-Mid-Hi]	dB(A)		40 - 42 - 44		45 - 49 - 51		45 - 49 - 51	
		Sound Level (PWL)	dB(A)		60		65		66	
		Dimensions	H x W x D		mm		943-950-330(+30)		1338-1050-330(+40)	
	Outdoor Unit	Weight	kg	70		116		123		116
Air Volume		Cooling	m³/min		55.0		110.0		120.0	
		Heating	m³/min		55.0		110.0		120.0	
Sound Level (SPL)		Cooling	dB(A)		47		49		50	
		Heating	dB(A)		48		51		52	
Sound Level (PWL)		Cooling	dB(A)		67		69		70	
		Heating	dB(A)		67		69		70	
Operating Current (max)		A	19.0		26.5		8.0		26.5	
Breaker Size		A	25		32		16		32	
Ext. Piping		Diameter	Liquid / Gas	mm		9.52 / 15.88		9.52 / 15.88		9.52 / 15.88
	Max. Length	Out-In	m		50		75		75	
	Max. Height	Out-In	m		30		30		30	
Guaranteed Operating Range [Outdoor]	Cooling*3	°C	-15 ~ +46		-15 ~ +46		-15 ~ +46		-15 ~ +46	
	Heating	°C	-20 ~ +21		-20 ~ +21		-20 ~ +21		-20 ~ +21	

*1 Refrigerant leakage contributes to climate change. Refrigerant with lower global warming potential (GWP) would contribute less to global warming than a refrigerant with higher GWP, if leaked to the atmosphere. This appliance contains a refrigerant fluid with a GWP equal to 1975. This means that if 1 kg of this refrigerant fluid would be leaked to the atmosphere, the impact on global warming would be 1975 times higher than 1 kg of CO₂, over a period of 100 years. Never try to interfere with the refrigerant circuit yourself or disassemble the product yourself and always ask a professional.
The GWP of R410A is 2088 in the IPCC 4th Assessment Report.
*2 Energy consumption based on standard test results. Actual energy consumption will depend on how the appliance is used and where it is located.
*3 Optional air protection guide is required where ambient temperature is lower than -5°C.

PSA-RP SERIES

STANDARD INVERTER

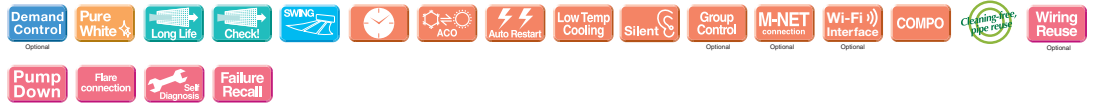

Type		Inverter Heat Pump								
Indoor Unit		PSA-RP100KA		PSA-RP125KA		PSA-RP140KA		PSA-RP140KA		
Outdoor Unit		PUHZ-P100VKA		PUHZ-P125VKA		PUHZ-P125VKA		PUHZ-P140VKA		
Refrigerant		R410A*1								
Power Supply		Outdoor power supply VKA:230 / Single / 50, YKA:400 / Three / 50								
Cooling	Capacity	Rated	9.4		9.4		12.1		13.6	
		Min - Max	3.7 - 10.6		3.7 - 10.6		5.6 - 13.0		5.6 - 13.0	
	Total Input	Rated	3.12		3.12		5.02		5.02	
	EER		3.01		3.01		2.41		2.41	
		EEL Rank	-		-		-		-	
	Design Load	kW	9.4		9.4		-		-	
	Annual Electricity Consumption*2	kWh/a	644		644		-		-	
	SEER		5.1		5.1		-		-	
		Energy Efficiency Class	A		A		-		-	
	Heating (Average Season)	Capacity	Rated	11.2		11.2		13.5		15.0
		Min - Max	2.8 - 12.5		2.8 - 12.5		4.8 - 15.0		4.8 - 15.0	
Total Input		Rated	3.28		3.28		4.80		4.82	
COP			3.41		3.41		2.81		2.81	
		EEL Rank	-		-		-		-	
Design Load		kW	8.0		8.0		-		-	
Declared Capacity		at reference design temperature	6.0 (-10°C)		6.0 (-10°C)		-		-	
		at bivalent temperature	7.0 (-7°C)		7.0 (-7°C)		-		-	
		at operation limit temperature	4.5 (-15°C)		4.5 (-15°C)		-		-	
Back Up Heating Capacity		kW	2.0		2.0		-		-	
Operating Current (max)	Input	Rated	20.7		12.2		27.2		12.2	
	Operating Current (max)	kW	0.11		0.11		0.11		0.11	
		A	0.71		0.71		0.73		0.73	
		Dimensions <Panel>	H x W x D		mm		1900 - 600 - 360		mm	
		Weight <Panel>	kg		46		46		48	
		Air Volume [Lo-Mid-Hi]	m³/min		25 - 28 - 30		25 - 28 - 31		25 - 28 - 31	
		Sound Level (SPL) [Lo-Mid-Hi]	dB(A)		45 - 49 - 51		45 - 49 - 51		45 - 49 - 51	
		Sound Level (PWL)	dB(A)		65		66		66	
		Dimensions	H x W x D		mm		981 - 1050 - 330		981 - 1050 - 330	
	Outdoor Unit	Weight	kg	76		78		84		85
Air Volume		Cooling	m³/min		79		86		86	
		Heating	m³/min		79		92		92	
Sound Level (SPL)		Cooling	dB(A)		51		54		56	
		Heating	dB(A)		54		56		57	
Sound Level (PWL)		Cooling	dB(A)		70		72		75	
		Heating	dB(A)		70		72		75	
Operating Current (max)		A	20.0		11.5		26.5		11.5	
Breaker Size		A	32		16		32		16	
Ext. Piping		Diameter	Liquid / Gas	mm		9.52 / 15.88		9.52 / 15.88		9.52 / 15.88
	Max. Length	Out-In	m		50		50		50	
	Max. Height	Out-In	m		30		30		30	
Guaranteed Operating Range [Outdoor]	Cooling*3	°C	-15 ~ +46		-15 ~ +46		-15 ~ +46		-15 ~ +46	
	Heating	°C	-15 ~ +21		-15 ~ +21		-15 ~ +21		-15 ~ +21	

*1 Refrigerant leakage contributes to climate change. Refrigerant with lower global warming potential (GWP) would contribute less to global warming than a refrigerant with higher GWP, if leaked to the atmosphere. This appliance contains a refrigerant fluid with a GWP equal to 1975. This means that if 1 kg of this refrigerant fluid would be leaked to the atmosphere, the impact on global warming would be 1975 times higher than 1 kg of CO₂, over a period of 100 years. Never try to interfere with the refrigerant circuit yourself or disassemble the product yourself and always ask a professional.
The GWP of R410A is 2088 in the IPCC 4th Assessment Report.
*2 Energy consumption based on standard test results. Actual energy consumption will depend on how the appliance is used and where it is located.
*3 Optional air protection guide is required where ambient temperature is lower than -5°C.

MULTI SPLIT

SERIES



SELECTION

Choose from types of indoor units and outdoor units that can run up to six indoor units each. Create the system that best matches room shapes and number of rooms.

R32 INDOOR UNITS		R32 OUTDOOR UNITS	
Wall-mounted MSZ-LN (18-25-35) MSZ-EF MSZ-AP15/20VG MSZ-AP25/35/42/50VG MSZ-AP60/71VG(K)	Floor-standing MFZ-KT Ceiling-suspended PCA Ceiling-concealed SEZ PEAD	2-port up to 2 indoor units MXZ-2F33VF(2) MXZ-2F42VF(2) MXZ-2F53VF(H)	3-port up to 3 indoor units MXZ-3F54VF(2) MXZ-3F68VF(2) 4-port up to 4 indoor units MXZ-4F72VF(2) MXZ-4F80VF2
Cassette MLZ-KP SLZ PLA			

R410A INDOOR UNITS		R410A OUTDOOR UNITS	
Wall-mounted MSZ-LN (25-35) MSZ-SF25-50VE MSZ-SF15-20VA MSZ-EF MSZ-AP15/20VG MSZ-AP25/35/42/50VG MSZ-GF	Floor-standing MFZ-KJ Ceiling-suspended PCA Ceiling-concealed SEZ PEAD	2-port up to 2 indoor units MXZ-2D33VA MXZ-2D42VA2 MXZ-2D53VA(H)2 MXZ-2E53VAHZ	3-port up to 3 indoor units MXZ-3E54VA MXZ-3E68VA 4-port up to 4 indoor units MXZ-4E72VA MXZ-4E83VA MXZ-4E83VAHZ
Cassette MLZ-KP SLZ PLA		5-port up to 5 indoor units MXZ-5E102VA	6-port up to 6 indoor units MXZ-6D122VA

CHECK SYSTEM COMPATIBILITY

Possible combinations depends on the outdoor unit chosen. Please check the following points.

Check Indoor Units

Refer to the "Indoor Unit Compatibility Table" to check if the indoor units selected can be used with the outdoor unit selected. (Indoor units not listed in the table cannot be used.)

Check Indoor Unit Capacity Combination

Refer to the "Combination Table" to check if the capacity combination of the indoor unit selected is connectable. (Combinations not listed cannot be connected.)

If the desired combination cannot be found, please change either the indoor or outdoor unit to match one of the combinations shown in the tables.

MXZ SERIES

Advancements in the MXZ Series include efficiency and flexibility in system expansion capabilities. The best solution when requiring multi-system air conditioning needs.

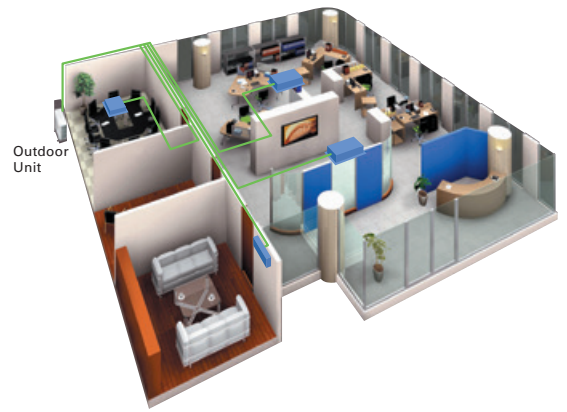

R32

2-port

MXZ-2F33VF(2)
MXZ-2F42VF(2)
MXZ-2F53VF(H)



R32

3-port 4-port

MXZ-3F54VF(2)
MXZ-3F68VF(2)
MXZ-4F72VF(2)
MXZ-4F80VF2

EXAMPLE SYSTEM

MXZ-4F72VF(2) system

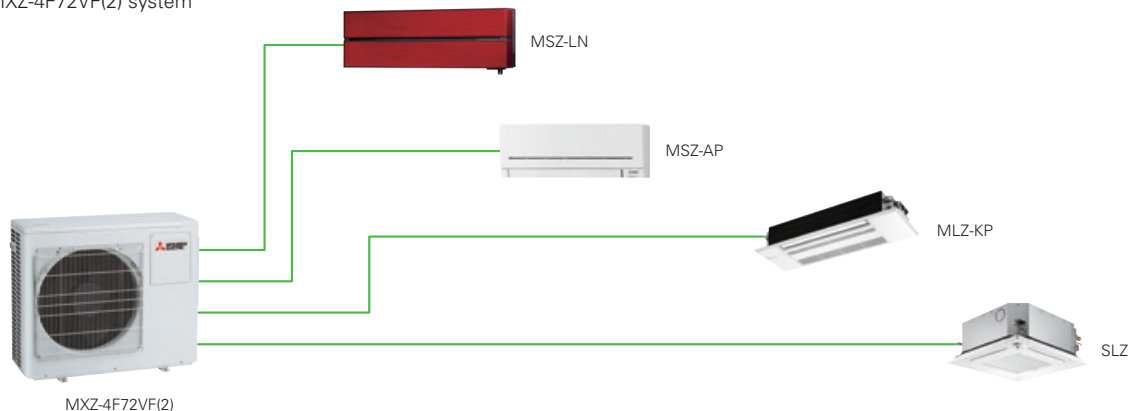

Handle Up to 4 Rooms with a Single Outdoor Unit

The MXZ Series for R32 offers a six-system line-up to choose from, ranging between 3.3 and 7.2kW. All of them are compatible with specific M, S and P series indoor units. A single outdoor unit can handle a wide range of building layouts.

Support Functions

Wiring/Piping Correction Function* (3F54/3F68/4F72/4F80)

Simply press a single button to confirm if wiring and piping are properly connected. Wiring errors are corrected automatically when discovered. This eliminates the need to confirm complicated wiring connections when expanding the system. (For details, refer to the outdoor unit installation manual.)

* Function cannot be used when the outdoor temperature is below 0°C. The correction process requires 10–20 minutes to complete and must be conducted with the unit set to the "Cooling" mode.

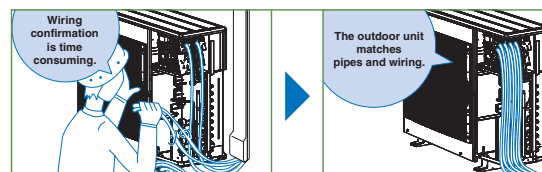

Operation Lock

To accommodate specific use applications, cooling or heating operation can be specified when setting the control board of the outdoor unit. A convenient option when a system needs to be configured for exclusive cooling or heating service. (For details, refer to the outdoor unit installation manual.)



Type (Inverter Multi - Split Heat Pump)				Up to 2 Indoor Units				Up to 3 Indoor Units		Up to 4 Indoor Units		
Indoor Unit				Please refer to *4								
Outdoor Unit				MXZ-2F33VF(2)	MXZ-2F42VF(2)	MXZ-2F53VF(2)	MXZ-2F53VF(H)	MXZ-3F54VF(2)	MXZ-3F68VF(2)	MXZ-4F72VF(2)	MXZ-4F80VF(2)	
Refrigerant				R32*1								
Power Supply				Outdoor power supply								
Source				220 - 230 - 240V / Single / 50Hz								
Outdoor (V / Phase / Hz)												
Cooling	EER ^(*)	Capacity	Rated	kW	3.3	4.2	5.3	5.3	5.4	6.8	7.2	8.0
		Input	Rated	kW	0.85	0.98	1.40	1.40	1.32	1.84	1.85	2.25
	SEER ^(*)	Design Load		kW	3.88	4.29	3.79	3.79	4.09	3.70	3.89	3.56
		Annual Electricity Consumption ^(**)		kWh/a	188	169	215	215	222	299	310	371
		Energy Efficiency Class ^(**)			6.13	8.69	8.63	8.63	8.52	7.96	8.13	7.55
Heating (Average Season)	COP ^(*)	Capacity	Rated	kW	4.0	4.5	6.4	6.4	7.0	8.6	8.6	8.8
		Input	Rated	kW	0.91	0.88	1.56	1.56	1.40	1.91	1.87	2.00
	Declared Capacity	Design Load		kW	4.40	5.11	4.10	4.10	5.00	4.50	4.60	4.40
		at reference design temperature		kW	2.7	3.2	3.2	3.2	5.0	6.8	7.0	7.0
		at biv alent temperature		kW	2.2	2.7	2.7	2.7	4.0	5.5	5.6	5.6
	Back Up Heating Capacity	at operation limit temperature		kW	2.4	2.9	2.9	2.9	4.5	6.1	6.2	6.2
		Annual Electricity Consumption ^(**)		kWh/a	1.8	2.3	2.3	2.1	3.2	4.6	4.8	4.8
		Energy Efficiency Class ^(**)			0.5	0.5	0.5	0.5	1.0	1.3	1.4	1.4
	SCOP ^(*)	Annual Electricity Consumption ^(**)		kWh/a	908	974	973	998	1520	2312	2410	2410
		Energy Efficiency Class ^(**)			4.16	4.60	4.60	4.49	4.61	4.12	4.07	4.07
Operating Current (Max)				A	10.0	12.2	12.2	12.2	18.0	18.0	18.0	18.0
Outdoor Unit	Dimensions		H*W*D	mm	550 - 800 (+69) - 285 (+59.5)				710 - 840 (+30) - 330 (+66)			
	Weight			kg	33	37	37	38	57	57	58	59
	Air Volume	Cooling		m ³ /min	31.5	28.4	32.7	32.7	31.0	35.4	35.4	35.4
		Heating		m ³ /min	32.3	33.5	34.7	34.7	27.2	39.6	42.7	42.7
	Sound Level (SPL)	Cooling		dB(A)	49	44	46	46	46	48	48	50
		Heating		dB(A)	50	50	51	51	50	53	54	55
	Sound Level (PWL)	Cooling		dB(A)	60	59	61	61	60	63	63	65
		Heating		dB(A)	4.1	4.7	6.2	6.2	5.7	8.0	8.1	10.1
Operating Current			A	4.4	4.3	7.1	7.1	6.1	8.4	8.2	10.1	
Breaker Size			A	15	15	15	15	25	25	25	25	
Ext. Piping	Port Diameter		Liquid/Gas	mm	6.35 × 2 / 9.52 × 2	6.35 × 2 / 9.52 × 2	6.35 × 2 / 9.52 × 2	6.35 × 2 / 9.52 × 2	6.35 × 3 / 9.52 × 3	6.35 × 3 / 9.52 × 3	6.35 × 4 / 12.7 × 1 + 9.52 × 3	6.35 × 4 / 12.7 × 1 + 9.52 × 3
	Total Piping Length (max)			m	20	30	30	30	50	60	60	60
	Each Indoor Unit Piping Length (max)			m	15	20	20	20	25	25	25	25
	Max. Height			m	10	15(10)*3	15(10)*3	15(10)*3	15(10)*3	15(10)*3	15(10)*3	15(10)*3
	Chargeless Length			m	20	30	30	30	50	60	60	60
Guaranteed Operating Range (Outdoor)				Cooling	°C							-10 ~ +46
				Heating	°C							-15 ~ +24

*1 Refrigerant leakage contributes to climate change. Refrigerant with lower global warming potential (GWP) would contribute less to global warming than a refrigerant with higher GWP, if leaked to the atmosphere. This appliance contains a refrigerant fluid with a GWP equal to 560. This means that if 1 kg of this refrigerant fluid would be leaked to the atmosphere, the impact on global warming would be 560 times higher than 1 kg of CO₂ over a period of 100 years. Never try to interfere with the refrigerant circuit yourself or disassemble the product yourself and always ask a professional. The GWP of R32 is 675 in the IPCC 4th Assessment Report.

*2 Energy consumption based on standard test results. Actual energy consumption will depend on how the appliance is used and where it is located.

*3 If the outdoor unit is installed higher than the indoor unit, max. height is reduced to 10m.

*4 EER/COP, SEER/SCOP values and energy efficiency class are measured when connected to the indoor units listed below.

- MXZ-2F33VF MSZ-AP15VF + MSZ-LN18VG
- MXZ-2F42VF MSZ-LN18VG + MSZ-LN25VG
- MXZ-2F53VF(H) MSZ-LN18VG + MSZ-LN35VG
- MXZ-3F54VF MSZ-LN18VG + MSZ-LN18VG + MSZ-LN18VG
- MXZ-3F68VF MSZ-LN18VG + MSZ-LN25VG + MSZ-LN25VG
- MXZ-4F72VF MSZ-LN18VG + MSZ-LN18VG + MSZ-LN18VG + MSZ-LN18VG

Method of Charging refrigerant

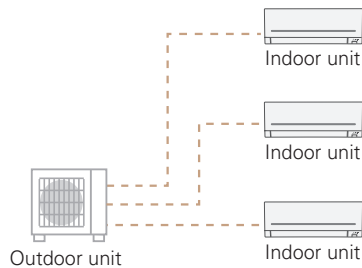

All the units MXZ-F-VF(2) are chargeless

MXZ SERIES

Advancements in the MXZ Series include efficiency and flexibility in system expansion capabilities. The best solution when requiring multi-system air conditioning needs.

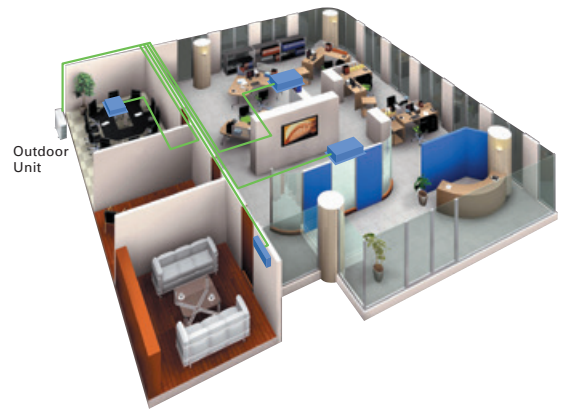

R410A

2-port

MXZ-2D33VA
MXZ-2D42VA2
MXZ-2D53VA (H)2



R410A

3-port 4-port

MXZ-3E54VA
MXZ-3E68VA
MXZ-4E72VA



R410A

4-port 5-port

MXZ-4E83VA
MXZ-5E102VA



R410A

6-port

MXZ-6D122VA2

EXAMPLE SYSTEM

MXZ-6D122VA2 system

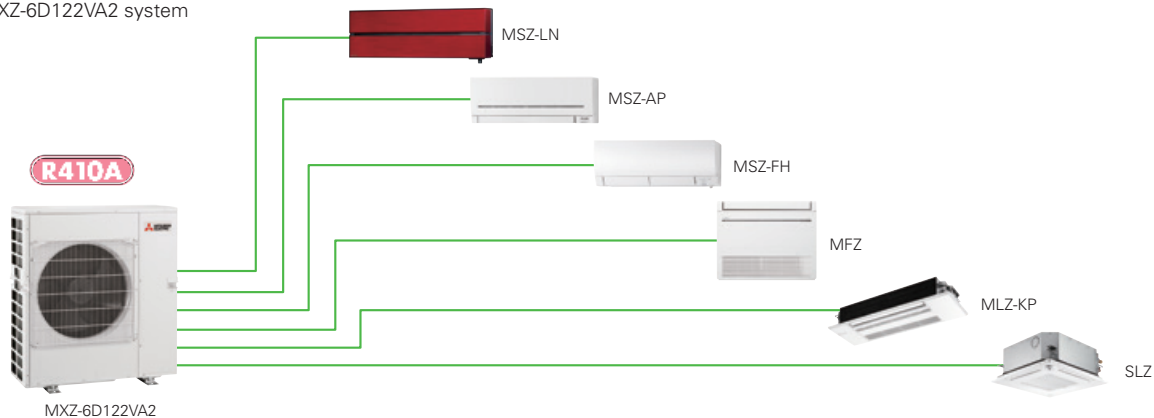

Handle Up to 6 Rooms with a Single Outdoor Unit

The MXZ Series offers a nine-system line-up to choose from, ranging between 3.3 and 12.2kW. All of them are compatible with specific M, S and P series indoor units. A single outdoor unit can handle a wide range of building layouts.

Support Functions

Wiring/Piping Correction Function* (3E54/3E68/4E72/4E83/5E102/6D122)

Simply press a single button to confirm if wiring and piping are properly connected. Wiring errors are corrected automatically when discovered. This eliminates the need to confirm complicated wiring connections when expanding the system. (For details, refer to the outdoor unit installation manual.)

* Function cannot be used when the outdoor temperature is below 0°C. The correction process requires 10–20 minutes to complete and must be conducted with the unit set to the "Cooling" mode.

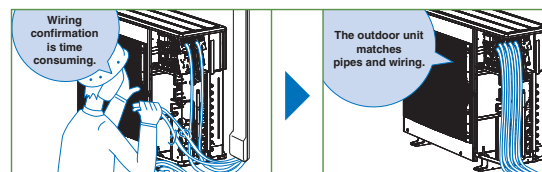

Ampere Limit Adjustment*

(4E83/5E102/6D122)

Dipswitch settings can be used to adjust the maximum electrical current for operation. This function is highly recommended for managing energy costs. (For details, refer to the outdoor unit installation manual.)

* Maximum capacity is lowered with the use of this function.

Operation Lock

To accommodate specific use applications, cooling or heating operation can be specified when setting the control board of the outdoor unit. A convenient option when a system needs to be configured for exclusive cooling or heating service. (For details, refer to the outdoor unit installation manual.)



Type (Inverter Multi - Split Heat Pump)			Up to 2 Indoor Units				Up to 3 Indoor Units		Up to 4 Indoor Units		Up to 5 Indoor Units		
Indoor Unit			Please refer to (*4)										
Outdoor Unit			N: MXZ-2D33VA	N: MXZ-2D42VA2	N: MXZ-2D53VA2	N: MXZ-2D53VAH2	N: MXZ-3E54VA	N: MXZ-3E68VA	N: MXZ-4E72VA	MXZ-4E83VA	MXZ-5E102VA		
Refrigerant			R410A**1										
Power Supply			Outdoor power supply 220 - 230 - 240V / Single / 50										
Cooling	Capacity	Rated	kW	3.3	4.2	5.3	5.3	5.4	6.8	7.2	8.3	10.2	
		Min - Max	kW	1.1 - 3.8	1.1 - 4.4	1.1 - 5.6	1.1 - 5.6	2.9 - 6.8	2.9 - 8.4	3.7 - 8.8	3.7 - 9.2	3.9 - 11.0	
	Input (Indoor+Outdoor)	Rated	kW	0.90	1.00	1.54	1.54	1.35	2.19	2.25	2.44	3.15	
	Design Load		kW	3.3	4.2	5.3	5.3	5.4	6.8	7.2	8.3	10.2	
	Annual Electricity Consumption*2		kWh/a	211	216	262	262	295	425	443	460	537	
Heating (Average Season)	Capacity	Rated	kW	4.0	4.5	6.4	6.4	7.0	8.6	8.6	9.3	10.5	
		Min - Max	kW	1.0 - 4.1	1.0 - 4.8	1.0 - 7.0	1.0 - 7.0	2.6 - 9.0	2.6 - 10.6	3.4 - 10.7	3.4 - 11.6	4.1 - 14.0	
	Input (Indoor+Outdoor)	Rated	kW	0.96	0.93	1.70	1.70	1.59	2.38	2.28	2.00	2.34	
	Design Load		kW	2.7	3.2	4.5	4.5	5.0	6.8	7.0	8.7	8.9	
	Declared Capacity	at reference design temperature	kW	2.1	2.7	3.7	3.6	4.0	5.4	5.6	7.1	7.3	
Max. Operating Current (Indoor+Outdoor)	Capacity	at bivalent temperature	kW	2.4	3.0	4.0	4.0	4.49	6.0	6.2	7.8	7.9	
		at operation limit temperature	kW	1.7	2.3	3.3	3.0	3.17	4.4	4.7	6.0	6.3	
	Back Up Heating Capacity		kW	0.6	0.5	0.8	0.9	1.0	1.4	1.4	1.6	1.6	
	Annual Electricity Consumption*2		kWh/a	926	1065	1507	1546	1751	2466	2516	2889	2958	
	SCOP**4			4.1	4.2	4.2	4.1	4.0	3.9	3.9	4.2	4.2	
	Energy Efficiency Class**4			A+	A+	A+	A+	A+	A	A	A+	A+	
	Max. Operating Current (Indoor+Outdoor)	A		10.0	12.2	12.2	12.2	18.0	18.0	18.0	21.4	21.4	
	Outdoor Unit	Dimensions	H x W x D	mm	550 - 800(+69) - 285(+59.5)				710 - 840(+30) - 330(+66)		796 - 950 - 330		
		Weight		kg	32	37	37	38	58	58	59	63	64
			Air Volume	Cooling	m ³ /min	32.9	27.7	32.9	32.9	42.1	42.1	42.1	55.6
Sound Level (SPL)		Heating	m ³ /min	33.7	33.3	33.3	33.3	43.0	43.0	43.0	55.6	68.0	
		Cooling	dB(A)	49	46	50	50	50	50	50	49	52	
Sound Level (PWL)		Heating	dB(A)	50	51	53	53	53	53	53	51	56	
		Cooling	dB(A)	63	60	64	64	64	64	64	61	65	
Breaker Size	A		10	15	15	15	25	25	25	25	25		
Ext. Piping	Diameter	Liquid	mm	6.35 x 2	6.35 x 2	6.35 x 2	6.35 x 2	6.35 x 3	6.35 x 3	6.35 x 4	6.35 x 4	6.35 x 5	
		Gas	mm	9.52 x 2	9.52 x 2	9.52 x 2	9.52 x 2	9.52 x 3	9.52 x 3	12.7x1+9.52x3	12.7x1+9.52x3	12.7x1+9.52x4	
	Total Piping Length (max)	m	20	30	30	30	50	60	60	70	80		
	Each Indoor Unit Piping Length (max)	m	15	20	20	20	25	25	25	25	25		
	Max. Height	m	10	15 (10)*3	15 (10)*3	15 (10)*3	15 (10)*3	15 (10)*3	15 (10)*3	15 (10)*3	15 (10)*3		
Guaranteed Operating Range [Outdoor]	Cooling	°C	-10 ~ +46	-10 ~ +46	-10 ~ +46	-10 ~ +46	-10 ~ +46	-10 ~ +46	-10 ~ +46	-10 ~ +46	-10 ~ +46		
	Heating	°C	-15 ~ +24	-15 ~ +24	-15 ~ +24	-20 ~ +24	-15 ~ +24	-15 ~ +24	-15 ~ +24	-15 ~ +24	-15 ~ +24		

N: Please refer to the NOTE below.

Type (Inverter Multi - Split Heat Pump)			Up to 6 Indoor Units			
Indoor Unit			Please refer to (*5)			
Outdoor Unit			MXZ-6D122VA2			
Refrigerant			R410A**1			
Power Supply			Outdoor power supply 220 - 230 - 240V / Single / 50			
Cooling	Capacity	Rated	kW	12.2		
		Min - Max	kW	3.5 - 13.5		
	Input**5	Rated	kW	3.66		
	EER**6			3.33		
Heating	Capacity	Rated	kW	14.0		
		Min - Max	kW	3.5 - 16.5		
	Input**5	Rated	kW	3.31		
	COP**6			4.23		
Operating Current (max)**5			A	26.8		
Outdoor Unit	Dimensions	H x W x D	mm	1048 - 950 - 330		
	Weight		kg	88		
		Air Volume	Cooling	m ³ /min	63.0	
	Sound Level (SPL)	Heating	m ³ /min	77.0		
		Cooling	dB(A)	55		
	Sound Level (PWL)	Heating	dB(A)	57		
		Cooling	dB(A)	70		
Breaker Size	A		32			
Ext. Piping	Diameter	Liquid	mm	6.35 x 6		
		Gas	mm	12.7x1+9.52x5		
	Total Piping Length (max)	m	80			
	Each Indoor Unit Piping Length (max)	m	25			
	Max. Height	m	15 (10)*3			
Guaranteed Operating Range [Outdoor]	Cooling	°C	-10 ~ +46			
	Heating	°C	-15 ~ +24			

NOTE

When connecting the MFZ-KJ series indoor unit(s) to this outdoor unit, charge additional refrigerant according to the instructions in the diagram below.

MXZ-2D33VA

No. of MFZ-KJ indoor units	Pipe length (L)		Maximum amount of refrigerant
	~20m		
1 unit	100g additional (Total 1250g)		1250g
2 units	Not available (Only one MFZ-KJ series indoor unit can be connected.)		

MXZ-2D42VA2 MXZ-2D53VA2 MXZ-2D53VAH2

No. of MFZ-KJ indoor units	Pipe length (L)		Maximum amount of refrigerant
	~20m		
1 unit	100g additional (Total 1400g)	100g+{(L-20)m x 20g/m}	1600g
2 units	200g additional (Total 1500g)	200g+{(L-20)m x 20g/m}	1700g

MXZ-3E54VA

No. of MFZ-KJ indoor units	Pipe length (L)		Maximum amount of refrigerant
	~40m		
1 unit	100g additional (Total 2800g)	100g+{(L-40)m x 20g/m}	3000g
2 units	200g additional (Total 2900g)	200g+{(L-40)m x 20g/m}	3100g
3 units	300g additional (Total 3000g)	300g+{(L-40)m x 20g/m}	3200g

MXZ-3E68VA MXZ-4E72VA

No. of MFZ-KJ indoor units	Pipe length (L)		Maximum amount of refrigerant
	~40m		
1 unit	100g additional (Total 2800g)	100g+{(L-40)m x 20g/m}	3200g
2 units	200g additional (Total 2900g)	200g+{(L-40)m x 20g/m}	3300g
3 units	300g additional (Total 3000g)	300g+{(L-40)m x 20g/m}	3400g

*1 Refrigerant leakage contributes to climate change. Refrigerant with lower global warming potential (GWP) would contribute less to global warming than a refrigerant with higher GWP, if leaked to the atmosphere. This appliance contains a refrigerant fluid with a GWP equal to 1975. This means that if 1 kg of this refrigerant fluid would be leaked to the atmosphere, the impact on global warming would be 1975 times higher than 1 kg of CO₂, over a period of 100 years. Never try to interfere with the refrigerant circuit yourself or disassemble the product yourself and always ask a professional.

*2 Energy consumption based on standard test results. Actual energy consumption will depend on how the appliance is used and where it is located.

*3 If the outdoor unit is installed higher than the indoor unit, max. height is reduced to 10m.

*4 EER/COP, EEL rank, SEER/SCOP values and energy efficiency class are measured when connected to the indoor units listed below.

MXZ-2D33VA → MSZ-SF15VA + MSZ-EF18VE
 MXZ-2D42VA2 → MSZ-EF18VE + MSZ-EF25VE
 MXZ-2D53VA(H)2 → MSZ-EF18VE + MSZ-EF35VE
 MXZ-3E54VA → MSZ-EF18VE + MSZ-EF18VE + MSZ-EF18VE
 MXZ-3E68VA → MSZ-EF18VE + MSZ-EF25VE + MSZ-EF25VE
 MXZ-4E72VA → MSZ-EF18VE + MSZ-EF18VE + MSZ-EF18VE + MSZ-EF18VE
 MXZ-4E83VA → MSZ-EF18VE + MSZ-EF18VE + MSZ-EF22VE + MSZ-EF25VE
 MXZ-5E102VA → MSZ-EF18VE + MSZ-EF18VE + MSZ-EF22VE + MSZ-EF22VE

*5 Power input and operating current (max) figures are for outdoor unit only

*6 EER/COP, EEL rank, values and energy efficiency class are measured when connected to the indoor units listed below.

MXZ-6D122VA2 → MSZ-EF18VE + MSZ-EF18VE + MSZ-EF18VE + MSZ-EF18VE + MSZ-EF25VE + MSZ-EF25VE

MXZ-HA SERIES

Multi-port outdoor units exclusively for MSZ-HR indoor units.



R32

2-port

MXZ-2HA40VF
MXZ-2HA50VF



R32

3-port

MXZ-3HA50VF

Stylish Design with Flat Panel Front

A stylish flat panel design is employed for the front of the indoor unit. The simple look matches room aesthetics.



Easy to create various combinations

Wide range of simple combinations only possible using multi-port outdoor units.

Two bedrooms



Three bedrooms

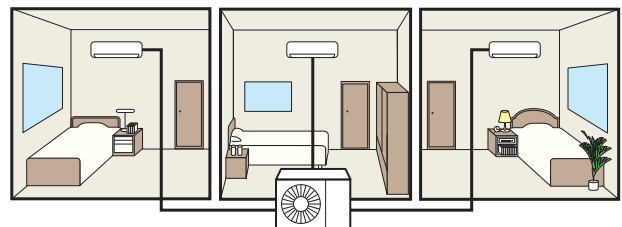

Living room and one bedroom

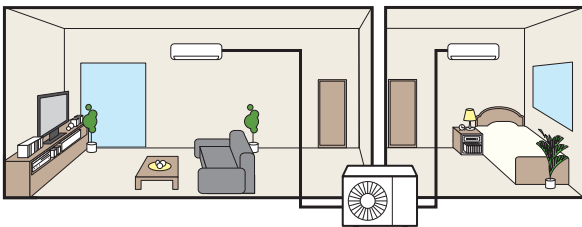

Wide living room

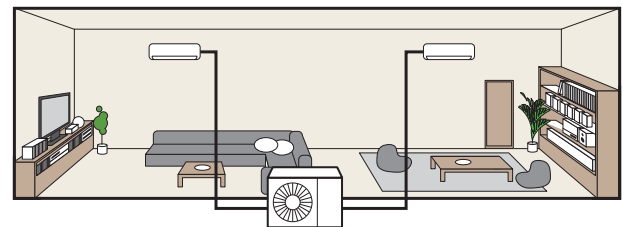

MXZ-HA SERIES

INVERTER MULTI



Type (Inverter Multi - Split Heat Pump)				Up to 2 Indoor Units		Up to 3 Indoor Units		
Indoor Unit				Please refer to (*4)				
Outdoor Unit				MXZ-2HA40VF	MXZ-2HA50VF	MXZ-3HA50VF		
Refrigerant				R32*1				
Power Source				Outdoor power supply				
Supply Outdoor (V/Phase/Hz)				220-230-240 / Single / 50				
Cooling	Capacity	Rated	kW	4.0	5.0	5.0		
	Input*4	Rated	kW	1.05	1.52	1.26		
	EER*4			3.81	3.29	3.97		
		EEL Rank*4		A	A	A		
	Design Load		kW	4.0	5.0	5.0		
	Annual Electricity Consumption*2		kWh/a	172	225	241		
	SEER*4			8.12	7.78	7.26		
		Energy Efficiency Class*4		A++	A++	A++		
	Heating (Average Season)	Capacity	Rated	kW	4.3	6.0	6.0	
		Input	Rated	kW	0.91	1.54	1.30	
COP*4				4.73	3.90	4.62		
		EEL Rank*4		A	A	A		
Design Load			kW	3.2	3.2	4.0		
Declared Capacity		at reference design temperature	kW	2.4	2.4	3.0		
		at bivalent temperature	kW	2.9	2.9	3.6		
		at operation limit temperature	kW	2.1	2.1	2.6		
Back Up Heating Capacity			kW	0.8	0.8	1.0		
Annual Electricity Consumption*2			kWh/a	1043	1043	1394		
SCOP*4			4.30	4.30	4.02			
	Energy Efficiency Class*4		A+	A+	A+			
Operating Current (max)				A	12.2	18.0		
Outdoor Unit	Dimensions	H x W x D	mm	550 - 800 (+69) - 285 (+59.5)	550 - 800 (+69) - 285 (+59.5)	710 - 840 (+30) - 330 (+66)		
	Weight		kg	37	37	57		
	Air Volume	Cooling	m ³ /min	28.4	32.7	31.0		
		Heating	m ³ /min	33.5	34.7	29.1		
	Sound Level (SPL)	Cooling	dB(A)	44	47	46		
		Heating	dB(A)	50	51	50		
	Sound Level (PWL)	Cooling	dB(A)	59	64	61		
		Heating	dB(A)	4.9	6.8	5.6		
	Operating Current	Cooling	A	4.9	6.8	5.6		
		Heating	A	4.6	6.9	5.8		
Breaker Size		A	15	15	25			
Ext. Piping	Port Diameter	Liquid / Gas	mm	6.35 x 2 / 9.52 x 2	6.35 x 2 / 9.52 x 2	6.35 x 3 / 9.52 x 3		
	Total Piping Length (max)		m	30	30	50		
	Each Indoor Unit Piping Length (max)		m	20	20	25		
	Max. Height		m	15 (10)*3	15 (10)*3	15 (10)*3		
	Chargeless Length		m	30	30	40		
Guaranteed Operating Range [Outdoor]	Cooling	°C		-10 ~ +46				
	Heating	°C		-15 ~ +24				

*1 Refrigerant leakage contributes to climate change. Refrigerant with lower global warming potential (GWP) would contribute less to global warming than a refrigerant with higher GWP, if leaked to the atmosphere. This appliance contains a refrigerant fluid with a GWP equal to 550. This means that if 1 kg of this refrigerant fluid would be leaked to the atmosphere, the impact on global warming would be 550 times higher than 1 kg of CO₂ over a period of 100 years. Never try to interfere with the refrigerant circuit yourself or disassemble the product yourself and always ask a professional. The GWP of R32 is 675 in the IPCC 4th Assessment Report.

*2 Energy consumption based on standard test results. Actual energy consumption will depend on how the appliance is used and where it is located.

*3 If the outdoor unit is installed higher than the indoor unit, max height is reduced to 10m.

*4 EER/COP, SEER/SCOP values and energy efficiency class are measured when connected to the indoor units listed below.

- MXZ-2HA40VF MSZ-HR25VF + MSZ-HR25VF
- MXZ-2HA50VF MSZ-HR25VF + MSZ-HR25VF
- MXZ-3HA50VF MSZ-HR25VF + MSZ-HR25VF + MSZ-HR25VF

MXZ-DM SERIES

Multi-port outdoor units exclusively for MSZ-HJ and DM indoor units.



R410A

2-port

MXZ-2DM40VA



R410A

3-port

MXZ-3DM50VA

Stylish Design with Flat Panel Front

A stylish flat panel design is employed for the front of the indoor unit. The simple look matches room aesthetics.



Easy to create various combinations

Wide range of simple combinations only possible using multi-port outdoor units.

Two bedrooms

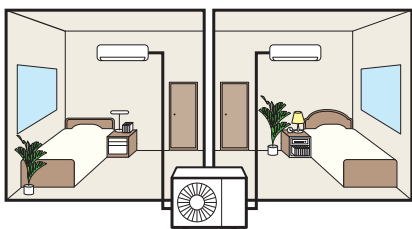

Three bedrooms

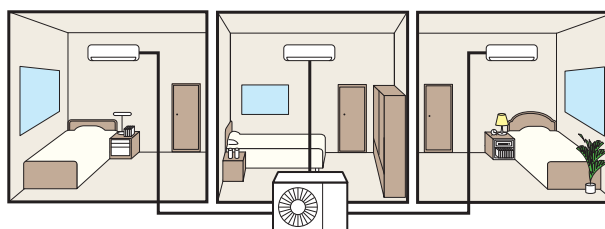

Living room and one bedroom

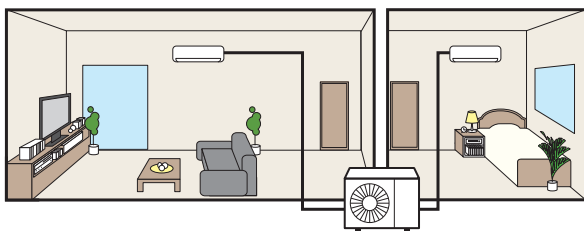

Wide living room

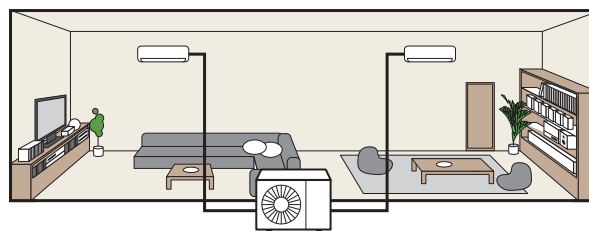

Attention MXZ-DM is exclusively for connection to MSZ-HJ and DM. Please check to make sure that wiring is done correctly.

For MXZ-DM

MSZ-HJ/DM

MXZ-2DM
MXZ-3DM

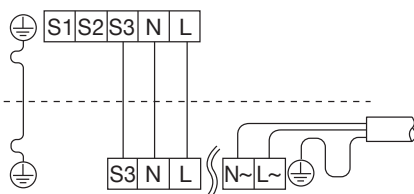

For MSZ-HJ/DM / MUZ-HJ/DM

MSZ-HJ/DM

MUZ-HJ/DM

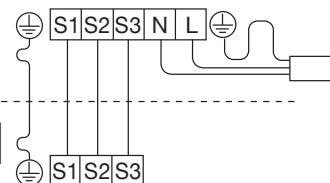

MXZ-DM SERIES

INVERTER MULTI



Type (Inverter Multi - Split Heat Pump)				Up to 2 Indoor Units		Up to 3 Indoor Units		
Indoor Unit						Please refer to (*4)		
Outdoor Unit				MXZ-2DM40VA		MXZ-3DM50VA		
Refrigerant				R410A*1				
Power Source				Outdoor power supply				
Supply Outdoor (V/Phase/Hz)				230 / Single / 50				
Cooling	Capacity	Rated	kW	4.0		5.0		
	Input*4	Rated	kW	1.05		1.13		
	EER*4			3.81		4.42		
		EEL Rank*4		A		A		
	Design Load		kW	4.0		5.0		
	Annual Electricity Consumption*2		kWh/a	226		283		
	SEER*4			6.1		6.1		
		Energy Efficiency Class*4		A++		A++		
Heating (Average Season)	Capacity	Rated	kW	4.3		6.0		
	Input	Rated	kW	1.16		1.31		
	COP*4			3.71		4.58		
		EEL Rank*4		A		A		
	Design Load		kW	3.2		4.0		
	Declared Capacity	at reference design temperature	kW	2.73		3.34		
		at bivalent temperature	kW	3.01		3.73		
		at operation limit temperature	kW	2.27		2.70		
	Back Up Heating Capacity		kW	0.47		0.66		
	Annual Electricity Consumption*2		kWh/a	1105		1455		
	SCOP*4			4.0		3.8		
	Energy Efficiency Class*4		A+		A			
Operating Current (max)				A		18.0		
Outdoor Unit	Dimensions	H x W x D	mm	550 - 800 (+69) - 285 (+59.5)		710 - 840 (+30) - 330 (+66)		
	Weight		kg	32		57		
	Air Volume	Cooling	m ³ /min		29.2		37.5	
		Heating	m ³ /min		31.9		39.6	
	Sound Level (SPL)	Cooling	dB(A)		48		50	
		Heating	dB(A)		52		53	
	Sound Level (PWL)	Cooling	dB(A)		63		64	
	Operating Current	Cooling	A		5.1		5.0	
		Heating	A		5.6		5.8	
	Breaker Size		A	15		25		
Ext. Piping	Port Diameter	Liquid / Gas	mm	6.35 x 2 / 9.52 x 2		6.35 x 3 / 9.52 x 3		
	Total Piping Length (max)		m	30		50		
	Each Indoor Unit Piping Length (max)		m	20		25		
	Max. Height		m	15 (10)*3		15 (10)*3		
	Chargeless Length		m	20		40		
Guaranteed Operating Range [Outdoor]	Cooling	°C			-10 ~ +46			
	Heating	°C			-15 ~ +24			

*1 Refrigerant leakage contributes to climate change. Refrigerant with lower global warming potential (GWP) would contribute less to global warming than a refrigerant with higher GWP, if leaked to the atmosphere. This appliance contains a refrigerant fluid with a GWP equal to 1975. This means that if 1 kg of this refrigerant fluid would be leaked to the atmosphere, the impact on global warming would be 1975 times higher than 1 kg of CO₂ over a period of 100 years. Never try to interfere with the refrigerant circuit yourself or disassemble the product yourself and always ask a professional.

*2 Energy consumption based on standard test results. Actual energy consumption will depend on how the appliance is used and where it is located.

*3 If the outdoor unit is installed higher than the indoor unit, max height is reduced to 10m.

*4 EER/COP, EEL rank, SEER/SCOP values and energy efficiency class are measured when connected to the indoor units listed below.

MXZ-2DM40VA MSZ-DM25VA + MSZ-DM25VA

MXZ-3DM50VA MSZ-DM25VA + MSZ-DM25VA + MSZ-DM25VA

PUMY-SP SERIES



R410A

PUMY-SP112/125/140VKM(-BS)
PUMY-SP112/125/140YKM(-BS)

Air conditioning system supports replacement work by simplifying the installation process. Ideal for supporting renewal needs at small offices and stores, home offices, etc.

EXAMPLE SYSTEM

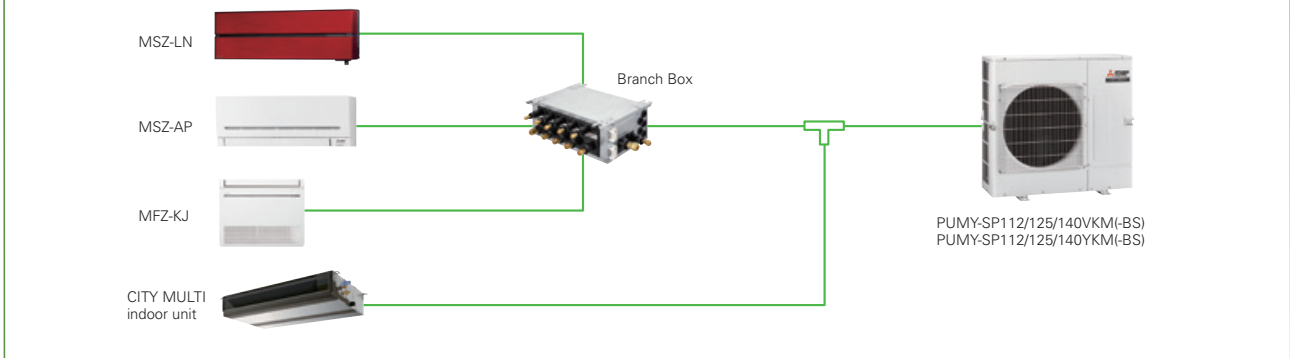

Light weight and compact size

Compact design fits into narrow outdoor unit space of condominiums and offices. Light weight design facilitates easy installation and transportation.

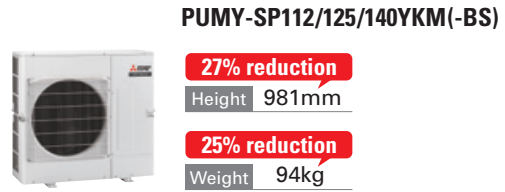
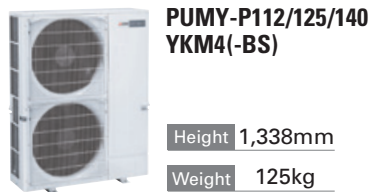

Unobstructive, compact, and easy to hide from view

Conventional 2-fan type outdoor units may spoil the view. Due to its compact size, the new outdoor fan unit can be installed in locations that would have been inappropriate.

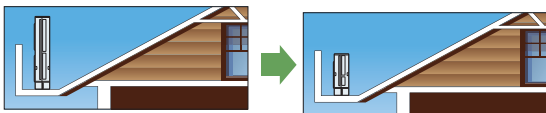

Easy installation and transportation

The reduced weight and height allow for better transportation performance. Carrying and installing become easier.

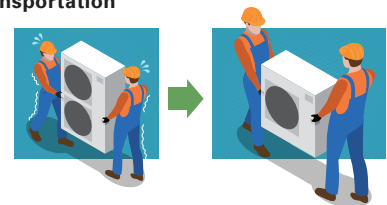

Industry's top energy efficiency*

Even with its compact size and light weight, it has a high EER and COP. Costs are reduced with the industry's best energy saving abilities.

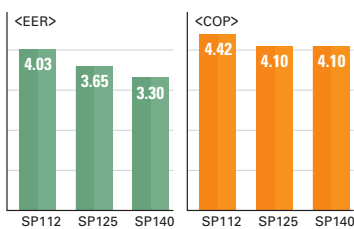

* As of sep.2017.Among VRF outdoor unit of 1fan. (An incompany investigation)

Super silent mode*

Noise level can be reduced up to 10dB(A). This allows you to operate the unit even in the night in a residential zone.

*Capacity reduction differs by mode setting.
*PAC-SC36NA-E is required to activate Super Silent mode.

An external static pressure of 30Pa

The installation location is flexible, thanks to its 30Pa static pressure. You can install it in locations that you could not before.

An external static pressure of 30Pa allows outdoor unit to be installed on balconies in high-rise building or spaces near louvers.

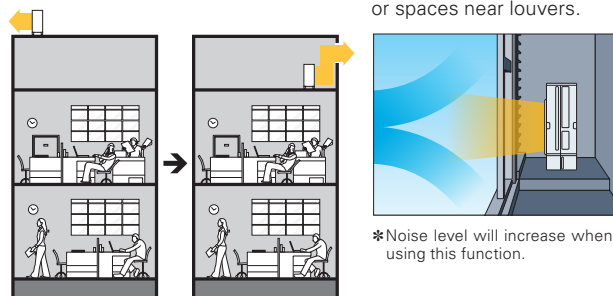

*Noise level will increase when using this function.

Rear piping is available

Freedom with layout due to its piping pullout locations in four directions

The in-door unit allows piping from any four directions; front, back, bottom, or right. This enables easier horizontal connection for collective layout.

The out-door unit with an expanded piping layout flexibility greatly improves piping workability.

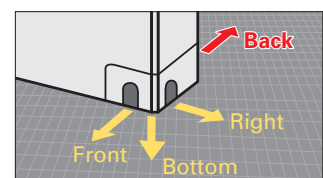



Model		PUMY-SP112VKM(-BS)	PUMY-SP125VKM(-BS)	PUMY-SP140VKM(-BS)	PUMY-SP112YKM(-BS)	PUMY-SP125YKM(-BS)	PUMY-SP140YKM(-BS)	
Power Source		1-phase 220 - 230 - 240V 50Hz / 220V 60Hz			3-phase 380 - 400 - 415V 50Hz / 380V 60Hz			
Cooling Capacity (nominal)	*1 kW	12.5	14.0	15.5	12.5	14.0	15.5	
	Power Input kW	3.10	3.84	4.70	3.10	3.84	4.70	
	Current Input A	14.38 - 13.75 - 13.18 / 14.38	17.81 - 17.04 - 16.33 / 17.81	21.80 - 20.85 - 19.88 / 21.80	4.96 - 4.71 - 4.54 / 4.96	6.14 - 5.83 - 5.62 / 6.14	7.52 - 7.14 - 6.88 / 7.52	
	EER kW/kW	4.03	3.65	3.30	4.03	3.65	3.30	
Temp. Range of Cooling¹⁵	Indoor Temp. W.B.	15.0 - +24.0°C	15.0 - +24.0°C	15.0 - +24.0°C	15.0 - +24.0°C	15.0 - +24.0°C	15.0 - +24.0°C	
	Outdoor Temp. D.B.	-5.0 - 52.0°C	-5.0 - 52.0°C	-5.0 - 52.0°C	-5.0 - 52.0°C	-5.0 - 52.0°C	-5.0 - 52.0°C	
Heating Capacity (nominal)	*2 kW	14.0	16.0	16.5	14.0	16.0	16.5	
	Power Input kW	3.17	3.90	4.02	3.17	3.90	4.02	
	Current Input A	14.70 - 14.06 - 13.48 / 14.70	18.09 - 17.30 - 16.58 / 18.09	18.85 - 17.83 - 17.09 / 18.85	5.07 - 4.82 - 4.64 / 5.07	6.24 - 5.93 - 5.71 / 6.24	6.43 - 6.11 - 5.89 / 6.43	
	COP kW/kW	4.42	4.10	4.10	4.42	4.10	4.10	
Temp. Range of Heating	Indoor Temp. D.B.	15.0 - 27.0°C	15.0 - 27.0°C	15.0 - 27.0°C	15.0 - 27.0°C	15.0 - 27.0°C	15.0 - 27.0°C	
	Outdoor Temp. W.B.	-20.0 - +15.0°C	-20.0 - +15.0°C	-20.0 - +15.0°C	-20.0 - +15.0°C	-20.0 - +15.0°C	-20.0 - +15.0°C	
Indoor Unit Connectable	Total Capacity 50 to 130% of outdoor unit capacity							
	Model / Quantity	City Multi	15 - 140 / 9	15 - 140 / 10	15 - 140 / 12	15 - 140 / 9	15 - 140 / 10	15 - 140 / 12
		Branch Box*10	15 - 100 / 8	15 - 100 / 8	15 - 100 / 8	15 - 100 / 8	15 - 100 / 8	15 - 100 / 8
	Mixed System	Branch Box 1 unit	City Multi	15 - 140 / 5	15 - 140 / 5	15 - 140 / 5	15 - 140 / 5	15 - 140 / 5
			Branch Box	15 - 100 / 5	15 - 100 / 5	15 - 100 / 5	15 - 100 / 5	15 - 100 / 5
		Branch Box 2 units	City Multi	15 - 140 / 3 or 2*8	15 - 140 / 3	15 - 140 / 3	15 - 140 / 3 or 2*8	15 - 140 / 3
Branch Box			15 - 100 / 7 or 8*8	15 - 100 / 8	15 - 100 / 8	15 - 100 / 7 or 8*8	15 - 100 / 8	15 - 100 / 8
Sound Pressure Level (Cooling / Heating)	dB <A>	52 / 54	53 / 56	54 / 56	52 / 54	53 / 56	54 / 56	
Sound Power Level (Cooling)	dB <A>	72	73	74	72	73	74	
Refrigerant Piping Diameter	Liquid Pipe mm	9.52 Flare						
	Gas Pipe mm	15.88 Flare						
Fan	Type x Quantity	Propeller Fan x 1						
	Air Flow Rate	m ³ /min	77	83	83	77	83	83
		L/s	1,283	1,383	1,383	1,283	1,383	1,383
		cfm	2,719	2,931	2,931	2,719	2,931	2,931
	Motor Output kW	0.20						
External Static Press. Pa	0 Pa / 30 Pa*3							
Compressor	Type x Quantity	Twin rotary hermetic compressor x 1						
	Starting Method	Inverter						
	Motor Output kW	3.1	3.5	3.7	3.1	3.5	3.7	
External Dimensions (H x W x D)	mm	981x1,050x330 (+40)						
Net Weight	kg (lbs)	93 (205)*6			94 (207)*7			
Pre-Charged Quantity	Weight kg	3.5	3.5	3.5	3.5	3.5	3.5	
	CO ₂ Equivalent t	7.31	7.31	7.31	7.31	7.31	7.31	
Max Added Quantity	Weight kg	9.0	9.0	9.0	9.0	9.0	9.0	
	CO ₂ Equivalent t	18.79	18.79	18.79	18.79	18.79	18.79	

*1, *2 Nominal conditions

	Indoor	Outdoor	Piping Length	Level Difference	External Static Press. (Outdoor Unit)
Cooling	27°C DB / 19°C WB	35°C	7.5m (24 - 9 / 16ft.)	0m (0ft)	0 Pa
Heating	20°C DB	7°C DB / 6°C WB	7.5m (24 - 9 / 16ft.)	0m (0ft)	0 Pa

*3 10 to 52°C; increase of connecting PKFY-P15/P20/P25VBM, PFFY-P20/P25/P32VKM, PFFY-P20/P25/P32VLE(R)M indoor unit and M series indoor unit with connection kit and M series, S series, and P series type indoor unit with branch box.

*4 Up to P100 when connecting via branch box. *5 Up to 11 units when connecting via 2 branch boxes.

*6 94 (207), for PUMY-SP112/125/140VKM(-BS) *7 95 (209), for PUMY-SP112/125/140YKM(-BS)

*8 When connecting 7 indoor units via branch box, connectable City Multi indoor units are 3; connecting 8 indoor units via branch box, connectable City Multi indoor units are 2.

*9 0 Pa as initial setting

*10 At least 2 indoor units must be connected when using branch box.

Type	Branch Box					
Model Name	PAC-MK53BC	PAC-MK33BC	PAC-MK53BCB	PAC-MK33BCB		
Connectable Number of Indoor Units	Max. 5	Max. 3	Max. 5	Max. 3		
Power Supply	Outdoor power supply, Branch Box / Outdoor separate power supply					
	1-phase, 220 - 230 - 240V, 50Hz					
Total Input	kW 0.003					
Operating Current	A 0.05					
Dimensions	H x W x D mm 170 - 450 - 280					
Weight	kg 7.4, 6.7, 7.0, 6.5					
Piping (diameter)	Branch (Indoor Side)	Liquid mm	6.35 x 5	6.35 x 3	6.35 x 5	6.35 x 3
		Gas mm	9.52 x 4, 12.7 x 1	9.52 x 3	9.52 x 4, 12.7 x 1	9.52 x 3
	Main (Outdoor Side)	Liquid mm	9.52			
		Gas mm	15.88			
Wiring	Connection Method		Flared		Brazed	
	to Indoor Unit		3-wire + Earth wire			
to Outdoor Unit		3-wire + Earth wire				

<Branch box compatible table>

Outdoor unit	Branch box	PAC-MK31/51BC(B)	PAC-MK32/52BC(B)	PAC-MK33/53BC(B)
PUMY-SP112/125/140V/YKM.TH(-BS)		✓	N/A	N/A
PUMY-SP112/125/140V/YKMR1.TH(-BS)		N/A	N/A	✓

[SP112-140V/YKM(-BS)]

Refrigerant Piping Lengths	Maximum meters	Vertical differentials between units	Maximum meters
Total length	120	Indoor/outdoor (outdoor higher)	50
Maximum allowable length	To City Multi indoor unit: 70	Indoor/outdoor (outdoor lower)	30
	Through Branch box: 80	Indoor/indoor	15*

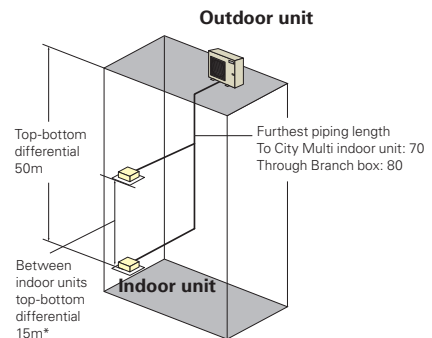

*In case of branch box connection: 12m

PUMY-P SERIES

Air conditioning system supports replacement work by simplifying the installation process. Ideal for supporting renewal needs at small offices and stores, home offices, etc.



R410A

PUMY-P112/125/140VKM4(-BS)
PUMY-P112/125/140YKM(E)4(-BS)
PUMY-P200YKM2(-BS)

EXAMPLE SYSTEM

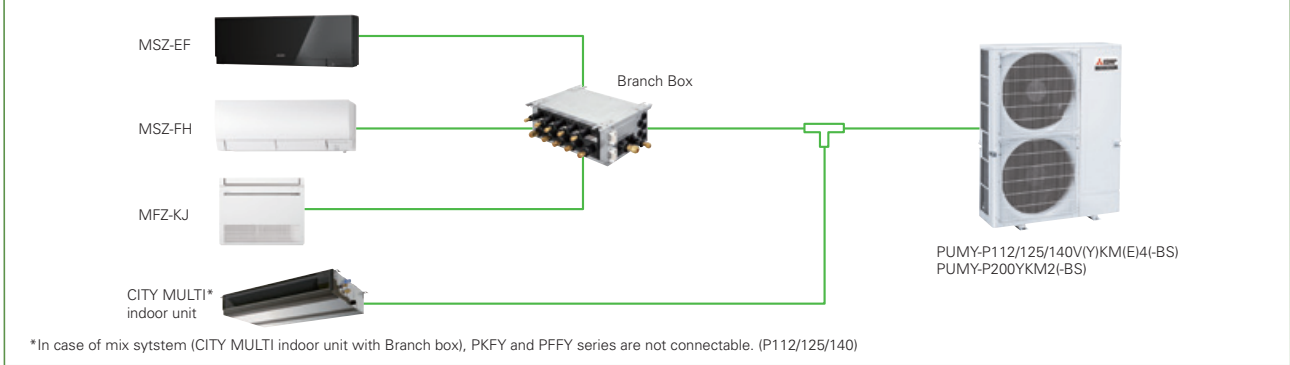

The two-pipe zoned system designed for Heat Pump Operation

PUMY series make use of a two-pipe refrigerant system, which allows for system changeover from cooling to heating, ensuring that a constant indoor climate is maintained in all zones. The compact outdoor unit utilizes R410A refrigerant and an INVERTER-driven compressor to use energy effectively.

With a wide range of indoor unit line-up in connection with a flexible piping system, PUMY series can be configured for all applications. Up to 12 indoor units can be connected with up to 130% connected capacity to maximize engineer's design options. This feature allows easy air conditioning in each area with convenient individual controllers.

Small Offices

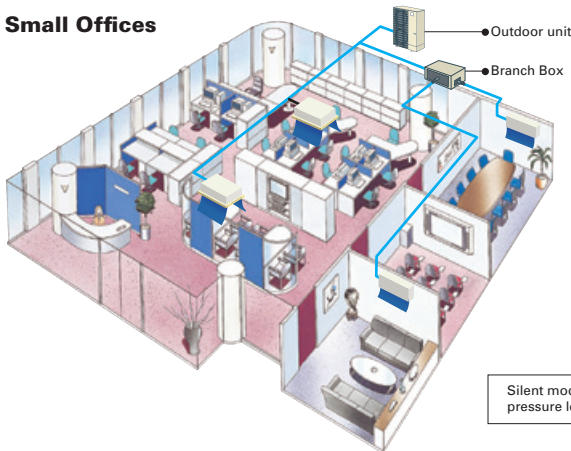

Residence

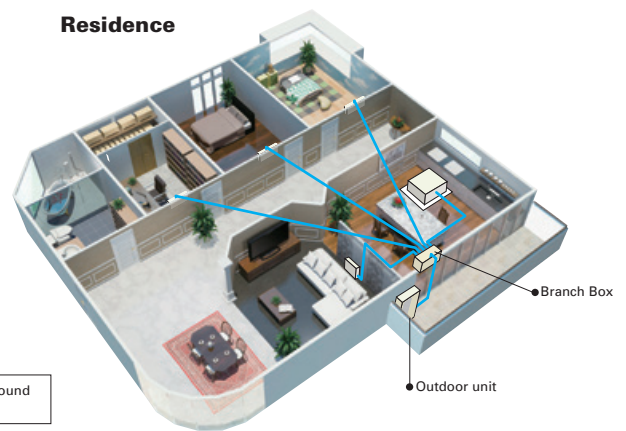

		Maximum Meters			
		Only City Multi ^{*1} Indoor Unit	Only Branch Box Connection	Mixed System (City Multi ^{*1} Indoor Unit + Branch Box)	
				City Multi ^{*1} Indoor Unit	Indoor Unit + Branch Box
P112/125/140	Refrigerant Piping Length	Total Length	300	150	240 (2 Branch boxes) / 300 (1 Branch box)
		Maximum Allowable Length	150 (175 equivalent)	80	85 (95 equivalent) / 80
		Farthest Indoor From First Branch	30	55	30 / 55
	Vertical Differentials Between Units	Indoor/Outdoor (Outdoor higher)	50	50	50
		Indoor/Outdoor (Outdoor Lower)	40 ^{*2}	40	40
		Indoor/Indoor	15 ^{*3}	15 ^{*3}	15 ^{*3}
P200	Refrigerant Piping Length	Total Length	150	150	150
		Maximum Allowable Length	80 (90 equivalent)	80	80 (90 equivalent) / 80
		Farthest Indoor From First Branch	30	55	30 / 55
	Vertical Differentials Between Units	Indoor/Outdoor (Outdoor higher)	50	50	50
		Indoor/Outdoor (Outdoor Lower)	40	40	40
		Indoor/Indoor	15 ^{*3}	15 ^{*3}	15 ^{*3}

*1 Include system with connection kit
*2 In case of including PKFY or PFFY, height between units is 30m.
*3 In case of branch box connection: 12m

30Pa external static pressure* Option (requires PAC-SJ71FM-E)

An external static pressure of 30Pa enables the outdoor unit to be installed on balconies in high-rise building or spaces near louvers.

* PUMY-P112/125/140VKM4(-BS), PUMY-P112/125/140YKM(E)4(-BS) only.
* Noise level will increase when using this function.

30Pa external static pressure fan motor (option)
(PAC-SJ71FM-E)

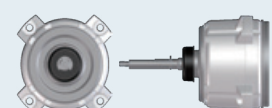



Model		PUMY-P112VKM4(-BS)	PUMY-P125VKM4(-BS)	PUMY-P140VKM4(-BS)	PUMY-P112YKM4(-BS)	PUMY-P125YKM4(-BS)	PUMY-P140YKM4(-BS)	PUMY-P200YKM2(-BS)	
Power Source		1-phase 220 - 230 - 240V 50Hz			3-phase 380 - 400 - 415V 50Hz				
Cooling Capacity (nominal)	*1 kW	12.5	14.0	15.5	12.5	14.0	15.5	22.4	
	Power Input kW	2.79	3.46	4.52	2.79	3.46	4.52	6.05	
	Current Input A	12.87 - 12.32 - 11.80	15.97 - 15.27 - 14.64	20.86 - 19.95 - 19.12	4.99 - 4.74 - 4.57	5.84 - 5.55 - 5.35	7.23 - 6.87 - 6.62	9.88 - 9.39 - 9.05	
	EER kW/kW	4.48	4.05	3.43	4.48	4.05	3.43	3.70	
Temp. Range of Cooling	Indoor Temp. W.B.	15.0 - 24.0°C	15.0 - 24.0°C	15.0 - 24.0°C	15.0 - 24.0°C	15.0 - 24.0°C	15.0 - 24.0°C	15.0 - 24.0°C	
	Outdoor Temp.*3 D.B.	-5.0 - 52.0°C	-5.0 - 52.0°C	-5.0 - 52.0°C	-5.0 - 52.0°C	-5.0 - 52.0°C	-5.0 - 52.0°C	-5.0 - 52.0°C	
Heating Capacity (nominal)	*2 kW	14.0	16.0	18.0	14.0	16.0	18.0	25.0	
	Power Input kW	3.04	3.74	4.47	3.04	3.74	4.47	5.84	
	Current Input A	14.03 - 13.42 - 12.86	17.26 - 16.51 - 15.82	20.63 - 19.73 - 18.91	5.43 - 5.16 - 4.98	6.31 - 6.00 - 5.78	7.15 - 6.79 - 6.55	9.54 - 9.06 - 8.74	
	COP kW/kW	4.61	4.28	4.03	4.61	4.28	4.03	4.28	
Temp. Range of Heating	Indoor Temp. D.B.	15.0 - 27.0°C	15.0 - 27.0°C	15.0 - 27.0°C	15.0 - 27.0°C	15.0 - 27.0°C	15.0 - 27.0°C	15.0 - 27.0°C	
	Outdoor Temp. W.B.	-20.0 - 15.0°C	-20.0 - 15.0°C	-20.0 - 15.0°C	-20.0 - 15.0°C	-20.0 - 15.0°C	-20.0 - 15.0°C	-20.0 - 15.0°C	
Indoor Unit Connectable	Total Capacity	50 to 130% of outdoor unit capacity							
	Model / Quantity	City Multi	15 - 140 / 9	15 - 140 / 10	15 - 140 / 12	15 - 140 / 9	15 - 140 / 10	15 - 140 / 12	15 - 200 / 12
		Branch Box*5	15 - 100 / 8	15 - 100 / 8	15 - 100 / 8	15 - 100 / 8	15 - 100 / 8	15 - 100 / 8	15 - 100 / 8
	Mixed System	Branch Box 1 unit	City Multi	15 - 140 / 5	15 - 140 / 5	15 - 140 / 5	15 - 140 / 5	15 - 140 / 5	15 - 200 / 5
		Branch Box 2 units	Branch Box	15 - 100 / 5	15 - 100 / 5	15 - 100 / 5	15 - 100 / 5	15 - 100 / 5	15 - 100 / 5
	City Multi	15 - 140 / 3 or 2**4	15 - 140 / 3	15 - 140 / 3	15 - 140 / 3 or 2**4	15 - 140 / 3	15 - 140 / 3	15 - 200 / 3	
	Branch Box	15 - 100 / 7 or 8**4	15 - 100 / 8	15 - 100 / 8	15 - 100 / 7 or 8**4	15 - 100 / 8	15 - 100 / 8	15 - 100 / 8	
Sound Pressure Level (measured in anechoic room)	dB <A>	49 / 51	50 / 52	51 / 53	49 / 51	50 / 52	51 / 53	56 / 61	
Refrigerant Piping Diameter	Liquid Pipe mm	9.52 Flare						9.52**6 Flare	
	Gas Pipe mm	15.88 Flare						19.1 Flare	
Fan	Type x Quantity	Propeller Fan x 2							
	Air Flow Rate	m ³ /min	110						139
		L/s	1,883						2,316
		cfm	3,884						4,908
Motor Output kW	0.074 + 0.074						0.20 + 0.20		
Compressor	Type x Quantity	Scroll hermetic compressor x 1							
	Starting Method	Inverter							
	Motor Output kW	2.9	3.5	3.9	2.9	3.5	3.9	5.3	
External Dimensions (H x W x D)	mm	1,338x1,050x330 (+40)							
Weight	kg	122			125				141

*1,*2 Nominal conditions

	Indoor	Outdoor	Piping Length	Level Difference
Cooling	27°C DB / 19°C WB	35°C	7.5m	0m
Heating	20°C DB	7°C DB / 6°C WB	7.5m	0m

*3 10 to 52°C D.B.: When connecting PKFY-P15/20/25VBM, PFFY-P20/25/32VKM and PFFY-P20/25/32VLE(R)M, PEFY-P-VMA3, M, S and P series indoor unit.

**4 When connecting 7 indoor units via branch box, connectable City Multi indoor units are 3; connecting 8 indoor units via branch box, connectable indoor units are 2.

**5 At least 2 indoor units must be connected when using branch box.

**6 Liquid pipe diameter: 12.7mm when piping length is more than 60m.

Model		PUMY-P112YKME4(-BS)	PUMY-P125YKME4(-BS)	PUMY-P140YKME4(-BS)		
Power Source		3-phase 380 - 400 - 415V 50Hz				
Cooling Capacity (nominal)	*1 kW	12.5	14.0	15.5		
	Power Input kW	2.79	3.46	4.52		
	Current Input A	4.99 / 4.74 / 4.57	5.84 / 5.55 / 5.35	7.23 / 6.87 / 6.62		
	EER kW/kW	4.48	4.05	3.43		
Temp. Range of Cooling	Indoor Temp. W.B.	15 to 24°C				
	Outdoor Temp.*3 D.B.	-5 to 52°C				
Heating Capacity (nominal)	*2 kW	14.0	16.0	18.0		
	Power Input kW	3.04	3.74	4.47		
	Current Input A	5.43 / 5.16 / 4.98	6.31 / 6.00 / 5.78	7.15 / 6.79 / 6.55		
	COP kW/kW	4.61	4.28	4.03		
Temp. Range of Heating	Indoor Temp. D.B.	15 to 27°C				
	Outdoor Temp. W.B.	-20 to 15°C				
Indoor Unit Connectable	Total Capacity	50 to 130% of outdoor unit capacity				
	Model / Quantity	City Multi	15 - 140 / 9	15 - 140 / 10	15 - 140 / 12	
		Branch Box*5	15 - 100 / 8	15 - 100 / 8	15 - 100 / 8	
	Mixed System	Branch Box 1 unit	City Multi	15 - 140 / 5	15 - 140 / 5	15 - 140 / 5
		Branch Box 2 units	Branch Box	15 - 100 / 5	15 - 100 / 5	15 - 100 / 5
	City Multi	15 - 140 / 3 or 2**4	15 - 140 / 3	15 - 140 / 3		
	Branch Box	15 - 100 / 7 or 8**4	15 - 100 / 8	15 - 100 / 8		
Sound Pressure Level (measured in anechoic room)	dB <A>	49 / 51	50 / 52	51 / 53		
Refrigerant Piping Diameter	Liquid Pipe mm	9.52 Flare				
	Gas Pipe mm	15.88 Flare				
Fan	Type x Quantity	Propeller Fan x 2				
	Air Flow Rate	m ³ /min	110			
		L/s	1,833			
		cfm	3,884			
Motor Output kW	0.074 + 0.074					
Compressor	Type x Quantity	Scroll hermetic compressor x 1				
	Starting Method	Inverter				
	Motor Output kW	2.9	3.5	3.9		
External Dimensions (H x W x D)	mm	1,338x1,050x330 (+40)				
Weight	kg	136				

*1,*2 Nominal conditions

	Indoor	Outdoor	Piping Length	Level Difference
Cooling	27°C DB / 19°C WB	35°C	7.5m	0m
Heating	20°C DB	7°C DB / 6°C WB	7.5m	0m

*3 10 to 52°C D.B.: When connecting PKFY-P15/20/25VBM, PFFY-P20/25/32VKM and PFFY-P20/25/32VLE(R)M, PEFY-P-VMA3, M, S and P series indoor unit.

**4 When connecting 7 indoor units via branch box, connectable City Multi indoor units are 3; connecting 8 indoor units via branch box, connectable indoor units are 2.

**5 At least 2 indoor units must be connected when using branch box.

Type		Branch Box				
Model Name		PAC-MK53BC	PAC-MK33BC	PAC-MK53BCB	PAC-MK33BCB	
Connectable Number of Indoor Units		Max. 5	Max. 3	Max. 5	Max. 3	
Power Supply	Source	Outdoor power supply, Branch Box / Outdoor separate power supply				
	Outdoor (V/Phase/Hz)	1-phase, 220/230/240V, 50Hz, 1-phase, 220V, 60Hz				
Total Input	kW	0.003				
Operating Current	A	0.05				
Dimensions	H x W x D mm	170 - 450 - 280				
Weight	kg	7.4	6.7	7.0	6.5	
Piping (diameter)	Branch (Indoor Side)	Liquid mm	6.35 x 5	6.35 x 3	6.35 x 5	6.35 x 3
		Gas mm	9.52 x 4, 12.7 x 1	9.52 x 3	9.52 x 4, 12.7 x 1	9.52 x 3
	Main (Outdoor Side)	Liquid mm	9.52			
		Gas mm	15.88			
	Connection Method		Flared		Brazed	
Wiring	to Indoor Unit	3-wire + Earth wire				
	to Outdoor Unit	3-wire + Earth wire				

Indoor Unit Compatibility Table

■ MXZ Series **R32**

Possible combinations of outdoor units and indoor units are shown below.

Indoor Unit		Outdoor Unit	Inverter Models Heat pump type									
			MXZ-2F33VF	MXZ-2F42VF	MXZ-2F53VF(H)	MXZ-3F54VF	MXZ-3F68VF	MXZ-4F72VF	MXZ-2HA40VF	MXZ-2HA50VF	MXZ-3HA50VF	
M series	Wall-Mounted	MSZ-LN18VG(W)(V)(R)(B)	●	●	●	●	●	●	●			
		MSZ-LN25VG(W)(V)(R)(B)	●	●	●	●	●	●				
		MSZ-LN35VG(W)(V)(R)(B)		●	●	●	●	●				
		MSZ-LN50VG(W)(V)(R)(B)										
		MSZ-AP15VF	●	●	●	●	●	●				
		MSZ-AP20VF	●	●	●	●	●	●				
		MSZ-AP25VG	●	●	●	●	●	●				
		MSZ-AP35VG		●	●	●	●	●				
		MSZ-AP42VG			●	●	●	●				
		MSZ-AP50VG			●	●	●	●				
		MSZ-FH25VE2										
		MSZ-FH35VE2										
		MSZ-FH50VE2										
		MSZ-EF18VG(W)(B)(S)	●	●	●	●	●	●				
		MSZ-EF22VG(W)(B)(S)	●	●	●	●	●	●				
		MSZ-EF25VG(W)(B)(S)	●	●	●	●	●	●				
		MSZ-EF35VG(W)(B)(S)		●	●	●	●	●				
		MSZ-EF42VG(W)(B)(S)			●	●	●	●				
		MSZ-EF50VG(W)(B)(S)			●	●	●	●				
		MSZ-SF15VA										
		MSZ-SF20VA										
		MSZ-SF25VE3										
		MSZ-SF35VE3										
		MSZ-SF42VE3										
	MSZ-SF50VE3											
	MSZ-GF60VE2											
	MSZ-GF71VE2											
	MSZ-DM25VA											
	MSZ-DM35VA											
	MSZ-HJ25VA											
	MSZ-HJ35VA											
	MSZ-HJ50VA											
MSZ-HR25VF							●	●	●			
MSZ-HR35VF							●	●	●			
MSZ-HR42VF								●	●	●		
MSZ-HR50VF									●	●		
Floor-Standing	MFZ-KJ25VE2											
	MFZ-KJ35VE2											
	MFZ-KJ50VE2											
1-way Cassette	MLZ-KP25VF	●	●	●	●	●	●					
	MLZ-KP35VF		●	●	●	●	●					
	MLZ-KP50VF				●	●	●					
S series	2x2 Cassette	SLZ-M15FA	●	●	●	●	●	●				
		SLZ-M25FA	●	●	●	●	●	●				
		SLZ-M35FA		●	●	●	●	●				
		SLZ-M50FA				●	●	●				
	Ceiling-Concealed	SEZ-M25DA*2	●	●	●	●	●	●				
		SEZ-M25DAL*2	●	●	●	●	●	●				
		SEZ-M35DA		●	●	●	●	●				
		SEZ-M35DAL		●	●	●	●	●				
		SEZ-M50DA				●	●	●				
		SEZ-M50DAL				●	●	●				
		SEZ-M60DA					●	●				
SEZ-M60DAL					●	●						
SEZ-M71DA												
SEZ-M71DAL												
P series	4-way Cassette	PLA-M50EA										
		PLA-M60EA										
		PLA-M71EA										
	Ceiling-Suspended	PCA-M50KA				●	●	●				
		PCA-M60KA					●	●				
		PCA-M71KA										
	Ceiling-Concealed	PEAD-M50JA				●*1	●*1	●*1				
		PEAD-M50JAL				●*1	●*1	●*1				
		PEAD-M60JA										
		PEAD-M60JAL										
PEAD-M71JA												
PEAD-M71JAL												

*1 Maximum total current of indoor units: 3A or less.

*2 SEZ-M25 cannot be connected with MXZ-2F/3F/4F when total capacity of connected indoor units is equivalent to outdoor capacity (capacity ratio is 1).

*3 MXZ outdoor units are not designed to operate with a single indoor unit with one-to-one piping work. Please install at least two indoor units.

MXZ Series R410A

Possible combinations of outdoor units and indoor units are shown below.

Indoor Unit	Outdoor Unit	Inverter Models Heat pump type													
		MXZ- ⁻³ 2D33VA	MXZ- ⁻³ 2D42VA2	MXZ- ⁻³ 2D53VA(H)2	MXZ- ⁻³ 2E53VAHZ	MXZ- ⁻³ 3E54VA	MXZ- ⁻³ 3E68VA	MXZ- ⁻³ 4E72VA	MXZ- ⁻³ 4E83VA	MXZ- ⁻³ 4E83VAHZ	MXZ- ⁻³ 5E102VA	MXZ- ⁻³ 6D122VA2	MXZ- ⁻³ 2DM40VA	MXZ- ⁻³ 3DM50VA	
M series	Wall-Mounted	MSZ-LN18VG(W)(V)(R)(B)													
		MSZ-LN25VG(W)(V)(R)(B)	●	●	●	●	●	●	●	●	●	●			
		MSZ-LN35VG(W)(V)(R)(B)		●	●	●	●	●	●	●	●	●			
		MSZ-LN50VG(W)(V)(R)(B)													
		MSZ-AP15VF	●	●	●	●	●	●	●	●	●	●	●		
		MSZ-AP20VF	●	●	●	●	●	●	●	●	●	●	●		
		MSZ-AP25VG ^{*7}	●	●	●	●	●	●	●	●	●	●	●		
		MSZ-AP35VG ^{*7}		●	●	●	●	●	●	●	●	●	●		
		MSZ-AP42VG ^{*7}			●	●	●	●	●	●	●	●	●		
		MSZ-AP50VG ^{*7}			●	●	●	●	●	●	●	●	●		
		MSZ-FH25VE2	●	●	●	●	●	●	●	●	●	●	●		
		MSZ-FH35VE2		●	●	●	●	●	●	●	●	●	●		
		MSZ-FH50VE2					●	●	●	●	●	●	●		
		MSZ-EF18VE3(W)(B)(S)	●	●	●	●	●	●	●	●	●	●	●		
		MSZ-EF22VE3(W)(B)(S)	●	●	●	●	●	●	●	●	●	●	●		
		MSZ-EF25VE3(W)(B)(S)	●	●	●	●	●	●	●	●	●	●	●		
		MSZ-EF35VE3(W)(B)(S)		●	●	●	●	●	●	●	●	●	●		
		MSZ-EF42VE3(W)(B)(S)			●	●	●	●	●	●	●	●	●		
		MSZ-EF50VE3(W)(B)(S)			●	●	●	●	●	●	●	●	●		
		MSZ-EF18VG(W)(B)(S)	●	●	●	●	●	●	●	●	●	●	●		
		MSZ-EF22VG(W)(B)(S)	●	●	●	●	●	●	●	●	●	●	●		
		MSZ-EF25VG(W)(B)(S)	●	●	●	●	●	●	●	●	●	●	●		
		MSZ-EF35VG(W)(B)(S)		●	●	●	●	●	●	●	●	●	●		
		MSZ-EF42VG(W)(B)(S)			●	●	●	●	●	●	●	●	●		
		MSZ-EF50VG(W)(B)(S)			●	●	●	●	●	●	●	●	●		
		MSZ-SF15VA	●	●	●	●	●	●	●	●	●	●	●		
		MSZ-SF20VA	●	●	●	●	●	●	●	●	●	●	●		
		MSZ-SF25VE3	●	●	●	●	●	●	●	●	●	●	●		
		MSZ-SF35VE3		●	●	●	●	●	●	●	●	●	●		
		MSZ-SF42VE3			●	●	●	●	●	●	●	●	●		
		MSZ-SF50VE3			●	●	●	●	●	●	●	●	●		
		MSZ-GF60VE2					●	●	●	●	●	●	●		
		MSZ-GF71VE2						●	●	●	●	●	●		
	MSZ-DM25VA												●	●	
	MSZ-DM35VA												●	●	
	MSZ-HJ25VA												●	●	
	MSZ-HJ35VA												●	●	
	MSZ-HJ50VA													●	
	MSZ-HR25VF														
	MSZ-HR35VF														
MSZ-HR42VF															
MSZ-HR50VF															
Floor-Standing	MFZ-KJ25VE2	● ^{*4*5}	● ^{*4}	● ^{*4}	●	● ^{*4}	● ^{*4}	●	●	●	●				
	MFZ-KJ35VE2		● ^{*4}	● ^{*4}	●	● ^{*4}	● ^{*4}	●	●	●	●				
	MFZ-KJ50VE2				●	● ^{*4}	● ^{*4}	●	●	●	●				
1-way Cassette	MLZ-KP25VF	●	●	●	●	●	●	●	●	●	●				
	MLZ-KP35VF		●	●	●	●	●	●	●	●	●				
	MLZ-KP50VF				●	●	●	●	●	●	●				
S series	2x2 Cassette	SLZ-M15FA													
		SLZ-M25FA	●	●	●	●	●	●	●	●	●	●			
		SLZ-M35FA		●	●	●	●	●	●	●	●	●			
		SLZ-M50FA					●	●	●	●	●	●			
	Ceiling-Concealed	SEZ-M25DA ^{*2}	●	●	●	●	●	●	●	●	●	●			
		SEZ-M25DAL ^{*2}	●	●	●	●	●	●	●	●	●	●			
		SEZ-M35DA		●	●	●	●	●	●	●	●	●			
		SEZ-M35DAL		●	●	●	●	●	●	●	●	●			
		SEZ-M50DA					●	●	●	●	●	●			
		SEZ-M50DAL					●	●	●	●	●	●			
		SEZ-M60DA						●	●	●	●	●			
		SEZ-M60DAL						●	●	●	●	●			
		SEZ-M71DA							●	●	●	●			
		SEZ-M71DAL							●	●	●	●			
P series	4-way Cassette	PLA-M50EA					●	●	●	●	●	●			
		PLA-M60EA						●	●	●	●	●	●		
		PLA-M71EA							●	●	●	●	●		
	Ceiling-Suspended	PCA-M50KA					●	●	●	●	●	●			
		PCA-M60KA						●	●	●	●	●	●		
		PCA-M71KA							●	●	●	●	●		
	Ceiling-Concealed	PEAD-M50JA					● ^{*1}	● ^{*1}	● ^{*1}	● ^{*1}	● ^{*1*6}	● ^{*1}	● ^{*1}		
		PEAD-M50JAL					● ^{*1}	● ^{*1}	● ^{*1}	● ^{*1}	● ^{*1*6}	● ^{*1}	● ^{*1}		
		PEAD-M60JA							● ^{*1}	● ^{*1}	● ^{*1*6}	● ^{*1}	● ^{*1}		
		PEAD-M60JAL								● ^{*1}	● ^{*1*6}	● ^{*1}	● ^{*1}		
								● ^{*1}	● ^{*1*6}	● ^{*1}	● ^{*1}				
								● ^{*1}	● ^{*1*6}	● ^{*1}	● ^{*1}				

^{*1} Maximum total current of indoor units: 3A or less.

^{*2} SEZ-KD25 cannot be connected with MXZ-2D(E)/3E/4E/5E when total capacity of connected indoor units is equivalent to outdoor capacity (capacity ratio is 1).

^{*3} MXZ outdoor units are not designed to operate with a single indoor unit with one-to-one piping work. Please install at least two indoor units.

^{*4} When connecting the MFZ-KJ Series indoor unit, additional refrigerant is required. For details, please refer to page 102.

^{*5} Regarding MXZ-2D33, the second unit should be a different type in the case of selecting one MFZ-KJ.

^{*6} P series cannot be connected with MXZ-4E83VAHZ when ampere limit adjustment function is operated.

^{*7} Connectable outdoor unit are MXZ-2D33VA-E4, MXZ-2D42VA2-E4, MXZ-2D53VA2-E4, MXZ-2E53VAHZ-E2, MXZ-3E54VA-E2, MXZ-3E68VA-E2, MXZ-4E72VA-E2, MXZ-4E83VA-E4, MXZ-4E83VAHZ-E3, MXZ-5E102VA-E4.

■ PUMY-SP Series

Branch Box Connection Compatibility Table

Series	Type	Model Name	Capacity										
			15	18	20	22	25	35	42	50	60	71	100
M series	Wall-Mounted	MSZ-LN•VG					●	●					
		MSZ-AP•VF/VG	●*1		●*1		●*1	●*1	●*1	●*1			
		MSZ-FH•VE2					●	●		●			
		MSZ-EF•VE3		●		●	●	●	●	●			
		MSZ-SF•VA	●		●								
		MSZ-SF•VE3					●	●	●	●			
	MSZ-GF•VE2										●	●	
Floor-Standing	MFZ-KJ•VE2					●*1	●*1		●*1				
1-way Cassette	MLZ-KP•VF					●*1	●*1		●*1				
S series	Ceiling-Concealed	SEZ-M•DA(L)					●*1	●*1		●*1	●*1	●*1	
	2x2 Cassette	SLZ-M•FA	●*1				●*1	●*1		●*1			
P series	Ceiling-Suspended	PCA-M•KA						●		●	●	●	●
	4-way Cassette	PLA-M•EA						●		●	●	●	●
	Ceiling-Concealed	PEAD-M•JA(L)								●	●	●	●

*1 Connectable outdoor units are PUMY-SP112/125/140V(Y)KMR1(-BS).TH only.

LEV Kit Connection Compatibility Table

Series	I/U Type	Model Name	Capacity										
			15	18	20	22	25	35	42	50	60	71	
M series	Wall-Mounted	MSZ-LN•VG					●	●					
		MSZ-AP•VF/VG	●*1		●*1		●*1	●*1	●*1	●*1			
		MSZ-FH•VE2					●	●		●			
		MSZ-EF•VE3		●		●	●	●	●	●			
		MSZ-SF•VA	●		●								
	MSZ-SF•VE3					●	●	●	●				
Floor-Standing	MFZ-KJ•VE2												

*1 Connectable outdoor units are PUMY-SP112/125/140V(Y)KMR1(-BS).TH only.

CITY MULTI Indoor Unit Compatibility Table

Series	Type	Model Name	Capacity												
			P15	P20	P25	P32	P40	P50	P63	P71	P80	P100	P125	P140	
CITY MULTI series	1-way Cassette	PMFY-P•VBM-E		●	●	●	●	●							
	2-way Cassette	PLFY-P•VLMD-E		●	●	●	●	●	●	●		●	●	●	
	4-way Cassette	PLFY-P•VEM-E		●	●	●	●	●	●	●		●	●	●	
		PLFY-EP•VEM-E *4							●	●		●			
	2x2 Cassette	PLFY-P•VFM-E1	●	●	●	●	●	●	●						
	Ceiling Concealed	PEFY-P•VMS1(L)-E	●	●	●	●	●	●	●						
		PEFY-P•VMA(L)-E		●	●	●	●	●	●	●	●	●	●	●	●
		PEFY-P•VMA3(L)-E *1			●	●	●	●	●						
		PEFY-P•VMH-E						●	●	●	●	●	●	●	●
		PEFY-P•VMR5-E/L/R		●	●	●									
	PEFY-P•VMH-E-F										●				●
	Ceiling Suspended	PCFY-P•VKM-E					●			●			●	●	
	Wall Mounted	PKFY-P•VBM-E	●	●	●										
		PKFY-P•VHM-E				●	●	●							
		PKFY-P•VKM-E								●			●		
	Floor Standing	PFFY-P•VLEM-E		●	●	●	●	●	●						
	Floor Mounted	PFFY-P•VKM-E2		●	●	●	●	●							
Concealed	PFFY-P•VLRM-E		●	●	●	●	●	●							
	PFFY-P•VLRMM-E		●	●	●	●	●	●							
Lossnay	GUF•RD(H)4 *3							●				●			

*1 Authorized connectable indoor units are as follows:
PUMY-SP112: PEFY-P25x2+P32x2, PUMY-SP125: PEFY-P25x1+P32x3, PUMY-SP140: PEFY-P32x2+P40x2

*2 Note that connection is not allowed inside EU countries.

PWFY can not connect to PUMY-SP series.

*3 Do not connect Lossnay remote controller(s). (PZ-61DR-E, PZ-60DR-E, PZ-52SF-E, PZ-43SMF-E)

*4 PLFY-EP can not connect more than 3units

■ PUMY-P Series

Branch Box Connection Compatibility Table

Series	Type	Model Name	Capacity										
			15	18	20	22	25	35	42	50	60	71	100
M series	Wall-Mounted	MSZ-LN•VG					●	●					
		MSZ-AP•VF/VG	●		●		●	●	●	●			
		MSZ-FH•VE2					●	●		●			
		MSZ-EF•VE3		●		●	●	●	●	●			
		MSZ-SF•VA	●		●								
		MSZ-SF•VE3					●	●		●	●		
	MSZ-GF•VE2										●	●	
Floor-Standing	MFZ-KJ•VE2					●	●		●				
1-way Cassette	MLZ-KP•VF					●	●		●				
S series	Ceiling-Concealed	SEZ-M•DA(L)					●	●		●	●	●	
	2x2 Cassette	SLZ-M•FA	●*1				●	●		●	●	●	
P series	Ceiling-Suspended	PCA-M•KA						●		●	●	●	●
	4-way Cassette	PLA-M•EA						●		●	●	●	●
	Ceiling-Concealed	PEAD-M•JA(L)								●	●	●	●

*1 PUMY-P200YKM2 is not connectable.

LEV Kit Connection Compatibility Table

Series	I/U Type	Model Name	Capacity										
			15	18	20	22	25	35	42	50	60	71	
M series	Wall-Mounted	MSZ-LN•VG					●	●					
		MSZ-AP•VF/VG	●		●		●	●	●	●			
		MSZ-FH•VE2					●	●		●			
		MSZ-EF•VE3		●		●	●	●	●	●			
		MSZ-SF•VA	●		●								
	MSZ-SF•VE3					●	●	●	●				
Floor-Standing	MFZ-KJ•VE2					●	●		●				

CITY MULTI Indoor Unit Compatibility Table

Series	Type	Model Name	Capacity											
			P15	P20	P25	P32	P40	P50	P63	P71	P80	P100	P125	P140
CITY MULTI series	1-way Cassette	PMFY-P•VBM-E		●	●	●	●	●						
	2-way Cassette	PLFY-P•VLM-D-E		●	●	●	●	●	●		●	●	●	
	4-way Cassette	PLFY-P•VEM-E		●	●	●	●	●	●		●	●	●	
		PLFY-EP•VEM-E*4						●	●		●			
	2x2 Cassette	PLFY-P•VFM-E1	●	●	●	●	●	●						
	Ceiling Concealed	PEFY-P•VMS1(L)-E	●	●	●	●	●	●	●					
		PEFY-P•VMA(L)-E		●	●	●	●	●	●	●	●	●	●	●
		PEFY-P•VMA3-E*1			●	●	●	●	●					
		PEFY-P•VMH-E					●	●	●	●	●	●	●	●
		PEFY-P•VMR-E-L/R		●	●	●								
		PEFY-P•VMH-E-F									●			●
	Ceiling Suspended	PCFY-P•VKM-E					●		●			●	●	
	Wall Mounted	PKFY-P•VBM-E	●	●	●									
		PKFY-P•VHM-E				●	●	●						
		PKFY-P•VKM-E							●			●		
	Floor Standing Floor Mounted Concealed	PFFY-P•VLEM-E		●	●	●	●	●	●					
		PFFY-P•VKM-E2		●	●	●	●	●						
		PFFY-P•VLRM-E		●	●	●	●	●	●					
		PFFY-P•VLRMM-E		●	●	●	●	●	●					
	Air to Water unit	PWFY-P•VM-E1/E2-AU*2										●		
Lossnay	GUF•RD(H)4*3							●			●			

*1 Authorized connectable indoor units are as follows;
PUMY-P112:PEFY-P25x2+P32x2, PUMY-P125:PEFY-P32x4, PUMY-P140:PEFY-P32x3+P40x1, PUMY-P200YKM2:PEFY-P40x2+P63x2

*2 Note that connection is not allowed inside EU countries.

PWFY can not connect to PUMY-P200YKM2.

*3 Do not connect Lossnay remote controller(s). (PZ-61DR-E, PZ-60DR-E, PZ-52SF-E, PZ-43SMF-E)

*4 PUMY-P112/125/140: PLY-EP can not connect more than 3 units

PUMY-P200: Authorized connectable indoor units are only as follows; PLY-EP63VEM-E x3.

POWERFUL HEATING

SERIES

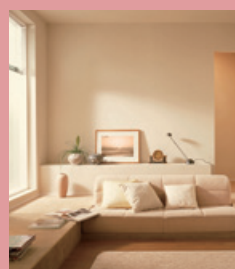

SELECTION

Choose the series that best matches the building layout.

MSZ-LN VGHZ, MSZ-FH/MFZ-KJ VEHZ SERIES

The line-up includes outdoor models 25–50

Outdoor Unit



R32
R410A

MUZ-LN25/35VGHZ
MUZ-FH25/35VEHZ
MUFZ-KJ25/35VEHZ



R32
R410A

MUZ-LN50VGHZ
MUZ-FH50VEHZ
MUFZ-KJ50VEHZ

Indoor Unit

Wall-mounted



R32
R410A

MSZ-LN25/35/50VG
(W)(V)(R)(B)



R410A

MSZ-FH25/35/50VE2

Floor-standing



R410A

MFZ-KJ25/35/50VE2

ZUBADAN

ZUBADAN SERIES

The line-up includes outdoor unit models 112-140 class and three types of indoor units.

Outdoor Unit

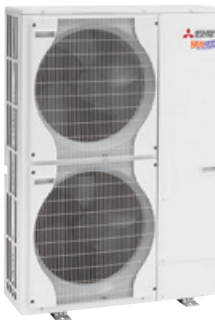

R410A

PUHZ-SHW112VHA
PUHZ-SHW112/140YHA

Indoor Unit

4-way cassette

R32
R410A



PLA Series

Wall-mounted

R32
R410A



PKA Series

Ceiling-concealed

R32
R410A



PEAD Series

MXZ-VAHZ SERIES

Outdoor Unit

R410A



MXZ-2E53VAHZ

R410A



MXZ-4E83VAHZ

LN VGHZ SERIES

FH VEHZ SERIES

R32 Single / Multi

R410A Multi

R410A Single / Multi

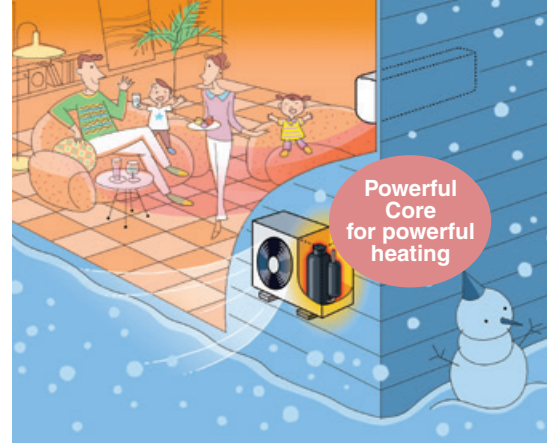

Unlike conventional air conditioning systems, the LN Series and FH Series don't lose heating capacity when it's cold outside. Original technologies ensure excellent heating performance under extremely low outdoor temperatures and an impressive guaranteed operating range.



MSZ-LN25/35/42VG(W)(V)(R)(B)



MSZ-FH25/35/50VE2

Unparalleled Heating Performance

LN Series and FH Series outdoor units are equipped with a high-output compressor that provides enhanced heating performance under low outdoor temperatures. The heating operation range is extended down to -25°C.

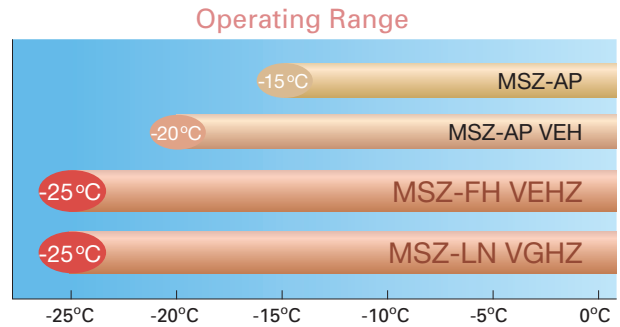
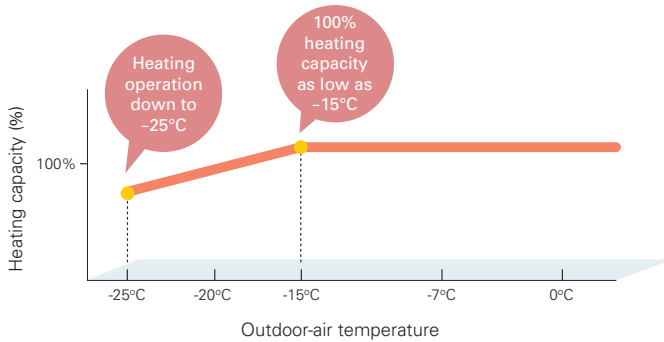

Declared Capacity (at reference design temperature)

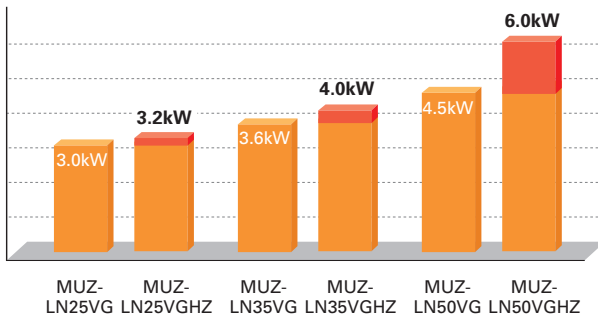

Declared Capacity (at reference design temperature)

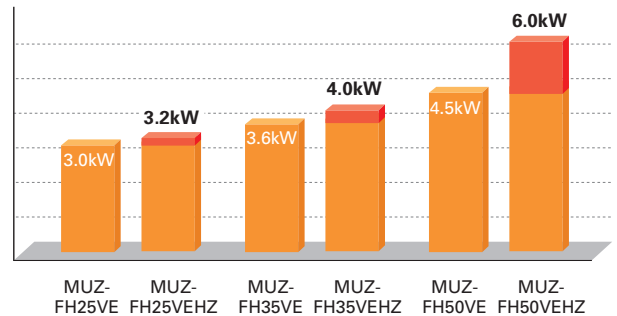

Compact, Powerful Compressor

A special manufacturing technology, "Heat Caulking Fixing Method," has been introduced to reduce compressor size while maintaining a high compressor output. This technology enables the installation of a powerful compressor in compact MUZ outdoor units. As a result, excellent heating performance is achieved when operating in cold outdoor environments.

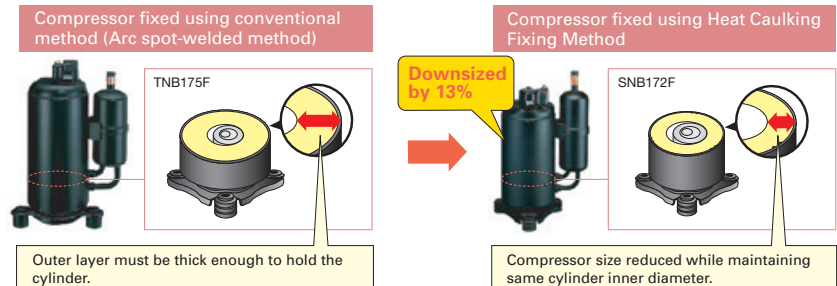

High Energy Efficiency – Energy Rank of A⁺ or higher for All Models

With indoor units that combine functionality, design and capacity and outdoor units equipped with a high-efficiency compressor, the MUZ-LN VGHZ and MUZ-FH VEHZ simultaneously achieves high heating capacity and energy-saving performance.

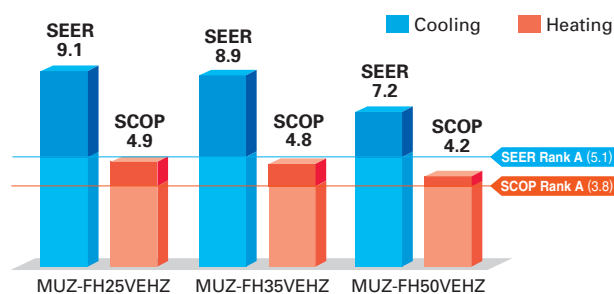
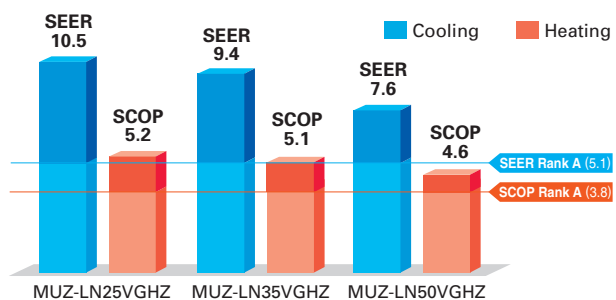

Freeze-prevention Heater Equipped as Standard

The Freeze-prevention heater restricts lowered capacity and operation shutdowns caused by the drain water freezing. This supports stable operation in low-temperature environments.

Operation Guaranteed at Outside Temperature of -25°C



Without Freeze-prevention heater



With Freeze-prevention heater

MSZ-LN VGHZ SERIES



Indoor Unit / Remote Controller



<Pearl White>

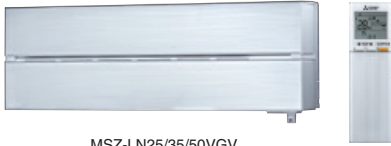

MSZ-LN25/35/50VGV

<Ruby Red>



MSZ-LN25/35/50VGR

<Natural White>



MSZ-LN25/35/50VGW

<Onyx Black>



MSZ-LN25/35/50VGB

Outdoor Unit



MUZ-LN25/35VGHZ



MUZ-LN50VGHZ



Type		Inverter Heat Pump					
Indoor Unit		MSZ-LN25VG(W)(V)(R)(B)	MSZ-LN35VG(W)(V)(R)(B)	MSZ-LN50VG(W)(V)(R)(B)			
Outdoor Unit		MUZ-LN25VGHZ	MUZ-LN35VGHZ	MUZ-LN50VGHZ			
Refrigerant		R32 ^{(*)1}					
Power Supply		Outdoor Power supply					
Source		230/Single/50					
Outdoor (V/Phase/Hz)							
Cooling	Design Load	kW	2.5	3.5	5.0		
	Annual Electricity Consumption ^{(*)2}	kWh/a	83	130	230		
	SEER ^{(*)4}	Energy Efficiency Class		10.5	9.4	7.6	
				A+++	A+++	A++	
	Capacity	Rated	kW	2.5	3.5	5.0	
		Min - Max	kW	0.8 - 3.5	0.8 - 4.0	1.4 - 5.8	
	Total Input	Rated	kW	0.485	0.820	1.380	
Heating (Average Season) ^{(*)5}	Design Load	kW	3.2 (-10°C)	4.0 (-10°C)	6.0 (-10°C)		
	Declared Capacity	at reference design temperature	kW	3.2 (-10°C)	4.0 (-10°C)	6.0 (-10°C)	
		at bivalent temperature	kW	3.2 (-10°C)	4.0 (-10°C)	6.0 (-10°C)	
		at operation limit temperature	kW	2.3 (-25°C)	3.1 (-25°C)	4.7 (-25°C)	
		Back Up Heating Capacity	kW	0.0 (-10°C)	0.0 (-10°C)	0.0 (-10°C)	
	Annual Electricity Consumption ^{(*)2}	kWh/a	849	1082	1826		
	SCOP ^{(*)4}	Energy Efficiency Class		5.2	5.1	4.6	
				A+++	A+++	A++	
	Capacity	Rated	kW	3.2	4.0	6.0	
		Min - Max	kW	1.0 - 6.3	1.0 - 6.6	1.8 - 8.7	
Total Input	Rated	kW	0.580	0.800	1.480		
Operating Current (max)		A	9.9	10.5	15.2		
Indoor Unit	Input	Rated	kW	0.029	0.029	0.034	
	Operating Current (max)		A	0.3	0.3	0.4	
	Dimensions		H x W x D	mm	307 - 890 - 233	307 - 890 - 233	307 - 890 - 233
	Weight		kg	15.5	15.5	15.5	
	Air Volume (SLo-Lo-Mid-Hi-SHi ^{(*)3} (Dry/Wet))	Cooling	m ³ /min	4.3 - 5.8 - 7.1 - 8.8 - 11.9	4.3 - 5.8 - 7.1 - 8.8 - 12.8	5.7 - 7.6 - 8.9 - 10.6 - 13.9	
		Heating	m ³ /min	4.0 - 5.7 - 7.1 - 8.5 - 14.4	4.3 - 5.7 - 7.1 - 8.5 - 13.7	5.4 - 6.4 - 8.5 - 10.7 - 15.7	
	Sound Level (SPL) (SLo-Lo-Mid-Hi-SHi ^{(*)3})	Cooling	dB(A)	19 - 23 - 29 - 36 - 42	19 - 24 - 29 - 36 - 43	27 - 31 - 35 - 39 - 46	
		Heating	dB(A)	19 - 24 - 29 - 36 - 45	19 - 24 - 29 - 36 - 45	25 - 29 - 34 - 39 - 47	
	Sound Level (PWL)		dB(A)	58	58	60	
	Dimensions		H x W x D	mm	550 - 800 - 285	550 - 800 - 285	880 - 840 - 330
Weight		kg	35	36	55		
Air Volume	Cooling	m ³ /min	31.4	33.8	48.8		
	Heating	m ³ /min	27.4	27.4	51.3		
Sound Level (SPL)	Cooling	dB(A)	46	49	51		
	Heating	dB(A)	49	50	54		
Sound Level (PWL)		dB(A)	60	61	64		
Operating Current (max)		A	9.6	10.2	14.8		
Breaker Size		A	10	12	16		
Ext. Piping	Diameter	Liquid / Gas	mm	6.35/9.52	6.35/9.52	6.35/9.52	
	Max. Length		Out-In	m	20	30	
	Max. Height		Out-In	m	12	15	
Guaranteed Operating Range (Outdoor)		Cooling	°C	-10 ~ +46	-10 ~ +46	-10 ~ +46	
		Heating	°C	-25 ~ +24	-25 ~ +24	-25 ~ +24	

(*)1 Refrigerant leakage contributes to climate change. Refrigerant with lower global warming potential (GWP) would contribute less to global warming than a refrigerant with higher GWP, if leaked to the atmosphere. This appliance contains a refrigerant fluid with a GWP equal to 550. This means that if 1 kg of this refrigerant fluid would be leaked to the atmosphere, the impact on global warming would be 550 times higher than 1 kg of CO₂ over a period of 100 years. Never try to interfere with the refrigerant circuit yourself or disassemble the product yourself and always ask a professional. The GWP of R32 is 675 in the IPCC 4th Assessment Report.

(*)2 Energy consumption based on standard test results. Actual energy consumption will depend on how the appliance is used and where it is located.

(*)3 SHi: Super High

(*)4 SEER, SCOP and other related description are based on COMMISSION DELEGATED REGULATION (EU) No.626/2011. The temperature conditions for calculating SCOP are based on "Average Season".

(*)5 Please see page 00 for heating (warmer season/colder season) specifications.

MSZ-FH VEHZ SERIES



Indoor Unit



MSZ-FH25/35/50VE2



Outdoor Unit

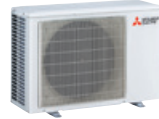

MUZ-FH25/35VEHZ



MUZ-FH50VEHZ

Remote Controller



Type		Inverter Heat Pump				
Indoor Unit		MSZ-FH25VE2	MSZ-FH35VE2	MSZ-FH50VE2		
Outdoor Unit		MUZ-FH25VEHZ	MUZ-FH35VEHZ	MUZ-FH50VEHZ		
Refrigerant		R410A ^{(*)1}				
Power Supply		Outdoor power supply				
Source		230 / Single / 50				
Outdoor (V/Phase/Hz)						
Cooling	Design Load	kW	2.5	3.5	5.0	
	Annual Electricity Consumption ^{(*)2}	kWh/a	96	138	244	
	SEER ^{(*)4}		9.1	8.9	7.2	
	Energy Efficiency Class			A+++	A++	
	Capacity	Rated	kW	2.5	3.5	5.0
		Min - Max	kW	0.8 - 3.5	0.8 - 4.0	1.9 - 6.0
Total Input	Rated	kW	0.485	0.820	1.380	
Heating (Average Season) ^{(*)5}	Design Load	kW	3.2	4.0	6.0	
	Declared Capacity	at reference design temperature	kW	3.2	4.0	6.0
		at bivalent temperature	kW	3.2	4.0	6.0
		at operation limit temperature	kW	1.7	2.6	3.8
	Back Up Heating Capacity		kW	0.0	0.0	0.0
	Annual Electricity Consumption ^{(*)2}	kWh/a	924	1173	2006	
	SCOP ^{(*)4}		4.9	4.8	4.2	
	Energy Efficiency Class			A++	A+	
	Capacity	Rated	kW	3.2	4.0	6.0
		Min - Max	kW	1.0 - 6.3	1.0 - 6.6	1.7 - 8.7
Total Input	Rated	kW	0.580	0.800	1.480	
Operating Current (max)		A	9.6	10.5	14.0	
Indoor Unit	Input	Rated	kW	0.029	0.029	0.031
	Operating Current (max)		A	0.4	0.4	0.4
	Dimensions		H x W x D	mm	305 (+17) - 925 - 234	
	Weight		kg	13.5	13.5	13.5
	Air Volume (SLo-Lo-Mid-Hi-SHi ^{(*)3} (Dry/Wet))	Cooling	m ³ /min	3.9 - 4.7 - 6.3 - 8.6 - 11.6 (10.5)	3.9 - 4.7 - 6.3 - 8.6 - 11.6 (10.5)	6.4 - 7.4 - 8.6 - 10.1 - 12.4
		Heating	m ³ /min	4.0 - 4.7 - 6.4 - 9.2 - 13.2	4.0 - 4.7 - 6.4 - 9.2 - 13.2	5.7 - 7.2 - 9.0 - 11.2 - 14.6
	Sound Level (SPL) (SLo-Lo-Mid-Hi-SHi ^{(*)3})	Cooling	dB(A)	20 - 23 - 29 - 36 - 42	21 - 24 - 29 - 36 - 42	27 - 31 - 35 - 39 - 44
		Heating	dB(A)	20 - 24 - 29 - 36 - 44	21 - 24 - 29 - 36 - 44	25 - 29 - 34 - 39 - 46
	Sound Level (PWL)		dB(A)	58	58	60
	Dimensions		H x W x D	mm	550 - 800 - 285	880 - 840 - 330
Weight		kg	37	37	55	
Air Volume	Cooling	m ³ /min	31.3	33.6	48.8	
	Heating	m ³ /min	31.3	33.6	51.3	
Sound Level (SPL)	Cooling	dB(A)	46	49	51	
	Heating	dB(A)	49	50	54	
Sound Level (PWL)		dB(A)	60	61	64	
Operating Current (max)		A	9.2	10.1	13.6	
Breaker Size		A	10	12	16	
Ext. Piping	Diameter	Liquid / Gas	mm	6.35 / 9.52	6.35 / 12.7	
	Max. Length	Out-In	m	20	30	
	Max. Height	Out-In	m	12	15	
Guaranteed Operating Range (Outdoor)			°C	-10 ~ +46	-10 ~ +46	
			°C	-25 ~ +24	-25 ~ +24	

(*)1 Refrigerant leakage contributes to climate change. Refrigerant with lower global warming potential (GWP) would contribute less to global warming than a refrigerant with higher GWP, if leaked to the atmosphere. This appliance contains a refrigerant fluid with a GWP equal to 1975. This means that if 1kg of this refrigerant fluid would be leaked to the atmosphere, the impact on global warming would be 1975 times higher than 1kg of CO₂ over a period of 100 years. Never try to interfere with the refrigerant circuit yourself or disassemble the product yourself and always ask a professional. The GWP of R410A is 2088 in the IPCC 4th Assessment Report.

(*)2 Energy consumption based on standard test results. Actual energy consumption will depend on how the appliance is used and where it is located.

(*)3 SHi: Super High

(*)4 SEER, SCOP and other related description are based on COMMISSION DELEGATED REGULATION (EU) No.626/2011. The temperature conditions for calculating SCOP are based on "Average Season".

(*)5 Please see page 00 for heating (warmer season) specifications.

MFZ-KJ SERIES



Indoor Unit

R410A
Single / Multi



MFZ-KJ25/35/50VE2



Outdoor Unit



MUFZ-KJ25/35VEHZ



MUFZ-KJ50VEHZ

Remote Controller



Type		Inverter Heat Pump				
Indoor Unit		MFZ-KJ25VE2	MFZ-KJ35VE2	MFZ-KJ50VE2		
Outdoor Unit		MUFZ-KJ25VEHZ	MUFZ-KJ35VEHZ	MUFZ-KJ50VEHZ		
Refrigerant		R410A ^{(*)1}				
Power Supply		Outdoor power supply				
Source		230 / Single / 50				
Outdoor (V/Phase/Hz)						
Cooling	Design Load	kW	2.5	3.5	5.0	
	Annual Electricity Consumption ^{(*)2}	kWh/a	102	150	266	
	SEER ^{(*)4}		8.5	8.1	6.5	
	Energy Efficiency Class			A+++	A++	A++
	Capacity	Rated	kW	2.5	3.5	5.0
		Min - Max	kW	0.5 - 3.4	0.5 - 3.7	1.6 - 5.7
	Total Input	Rated	kW	0.540	0.940	1.410
Heating (Average Season)	Design Load	kW	3.5	3.6	4.5	
	Declared Capacity	at reference design temperature	kW	3.5	3.6	4.5
		at bivalent temperature	kW	3.5	3.6	4.5
		at operation limit temperature	kW	1.6	2.3	3.3
	Back Up Heating Capacity		kW	0.0	0.0	0.0
	Annual Electricity Consumption ^{(*)2}	kWh/a	1104	1158	1467	
	SCOP ^{(*)4}		4.4	4.3	4.2	
	Energy Efficiency Class			A+	A+	A+
	Capacity	Rated	kW	3.4	4.3	6.0
		Min - Max	kW	1.2 - 5.1	1.2 - 5.8	2.2 - 8.4
Total Input	Rated	kW	0.770	1.100	1.610	
Operating Current (max)		A	4.42	3.91	3.73	
Indoor Unit	Input	Rated	kW	0.016	0.016	0.038
		Operating Current (max)	A	0.17	0.17	0.34
	Dimensions	H x W x D	mm	600 - 750 - 215		
	Weight		kg	15	15	15
	Air Volume (SLo-Lo-Mid-Hi-SHi ^{(*)3} (Dry/Wet))	Cooling	m ³ /min	3.9 - 4.9 - 5.9 - 7.1 - 8.2	3.9 - 4.9 - 5.9 - 7.1 - 8.2	5.6 - 6.7 - 8.0 - 9.3 - 10.6
		Heating	m ³ /min	3.9 - 5.1 - 6.2 - 7.7 - 9.7	3.9 - 5.1 - 6.2 - 7.7 - 9.7	6.0 - 7.4 - 9.4 - 11.6 - 14.0
	Sound Level (SPL) (SLo-Lo-Mid-Hi-SHi ^{(*)3})	Cooling	dB(A)	20 - 25 - 30 - 35 - 39	20 - 25 - 30 - 35 - 39	27 - 31 - 35 - 39 - 44
		Heating	dB(A)	19 - 25 - 30 - 35 - 41	19 - 25 - 30 - 35 - 41	29 - 35 - 40 - 45 - 50
	Sound Level (PWL)		dB(A)	49	50	56
	Outdoor Unit	Dimensions	H x W x D	mm	550 - 800 - 285	880 - 840 - 330
Weight			kg	37	37	55
Air Volume		Cooling	m ³ /min	31.3	31.3	45.8
		Heating	m ³ /min	33.6	33.6	45.8
Sound Level (SPL)		Cooling	dB(A)	46	47	49
		Heating	dB(A)	51	51	51
Sound Level (PWL)		Cooling	dB(A)	59	60	63
Operating Current (max)			A	9.2	10	13.6
Breaker Size			A	10	12	16
Ext. Piping		Diameter	Liquid / Gas	mm	6.35 / 9.52	6.35 / 9.52
	Max. Length	Out-In	m	20	20	30
	Max. Height	Out-In	m	12	12	15
Guaranteed Operating Range (Outdoor)	Cooling	°C	-10 ~ +46	-10 ~ +46	-10 ~ +46	
	Heating	°C	-25 ~ +24	-25 ~ +24	-25 ~ +24	

(*)1 Refrigerant leakage contributes to climate change. Refrigerant with lower global warming potential (GWP) would contribute less to global warming than a refrigerant with higher GWP, if leaked to the atmosphere. This appliance contains a refrigerant fluid with a GWP equal to 1975. This means that if 1 kg of this refrigerant fluid would be leaked to the atmosphere, the impact on global warming would be 1975 times higher than 1 kg of CO₂ over a period of 100 years. Never try to interfere with the refrigerant circuit yourself or disassemble the product yourself and always ask a professional. The GWP of R410A is 2088 in the IPCC 4th Assessment Report.

(*)2 Energy consumption based on standard test results. Actual energy consumption will depend on how the appliance is used and where it is located.

(*)3 SHi: Super High

(*)4 SEER, SCOP and other related description are based on COMMISSION DELEGATED REGULATION (EU) No.626/2011. The temperature conditions for calculating SCOP are based on "Average Season".

ZUBADAN SERIES

The ZUBADAN Series incorporates an original Flash Injection technology that improves the already high heating capacity of the system. This new member of the series line-up ensures comfortable heat pump-driven heating performance in cold regions.



* Units in photo are Japanese models.
European model specifications are different.

Improved Heating Performance

Mitsubishi Electric's unique "Flash Injection" circuit achieves remarkably high heating performance. This technology has resulted in an excellent heating capacity rating in outdoor temperatures as low as -15°C , and the guaranteed heating operation range of the heating mode has been extended to -25°C . Accordingly, the heat-pump units of the ZUBADAN Series are perfect for warming homes in the coldest of regions.

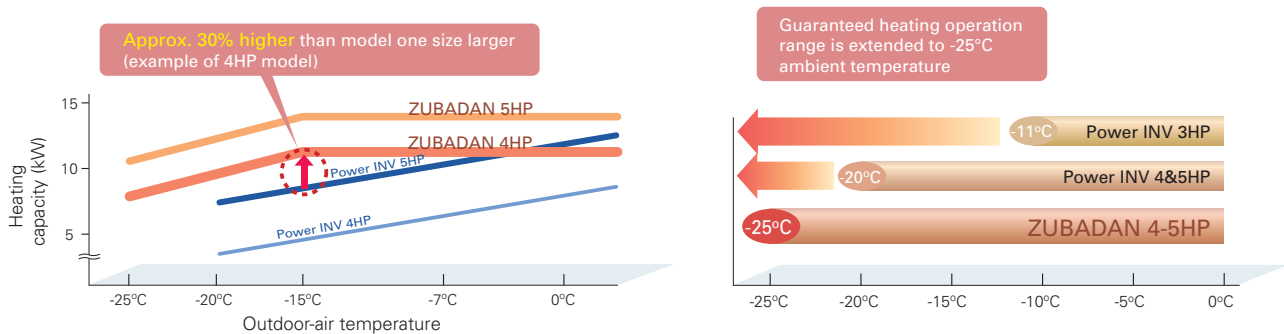

Enhanced Comfort

The Flash Injection circuit improves start-up and recover from the defrosting operation. A newly introduced defrost operation control also improves defrost frequency. These features enable the temperature to reach the set temperature more quickly, and contribute to maintaining it at the desired setting.

Quick Start-up

■ Operation at $+2^{\circ}\text{C}$ outdoor temperature

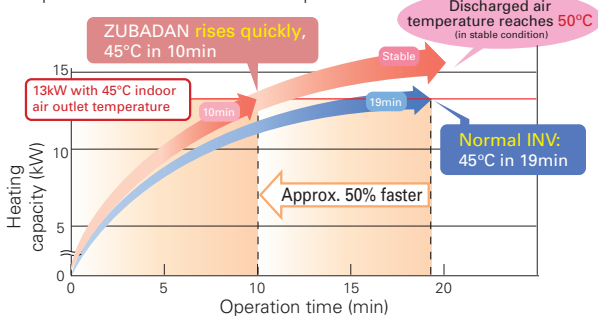

■ Operation at -20°C outdoor temperature

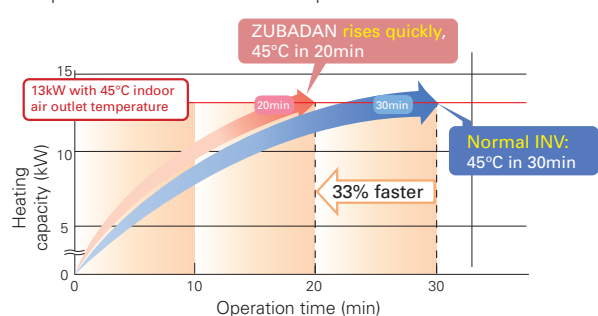

ZUBADAN Defrost Control and Faster Recovery from Defrost Operation

Field Test Results: Office building in Asahikawa, Hokkaido, Japan

■ Operation data for 25 Jan. 2005

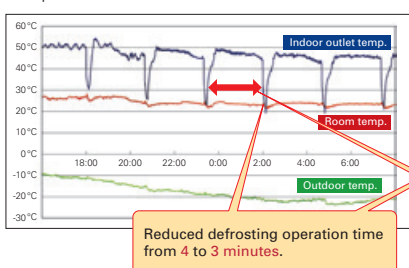

■ Operation data for 2 Dec. 2004

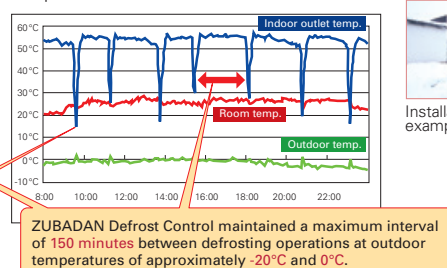

Installation example



ErP Lot 10 Compliant with High Energy-efficiency Achieving SEER/SCOP Rank A and A+



Powerful heating yet annually high energy efficiency in both cooling and heating, achieving rank A and A+.

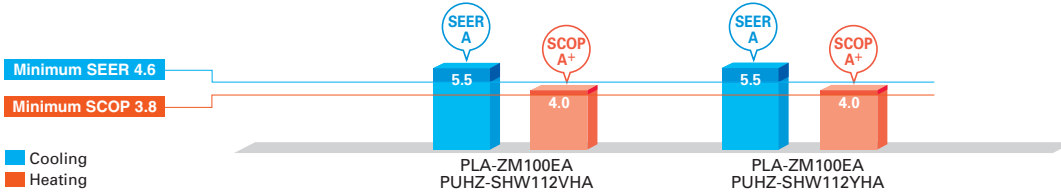

Mitsubishi Electric's Flash Injection Technology The Key to High Heating Performance at Low Outdoor Temperatures

Flash Injection Circuit

ZUBADAN

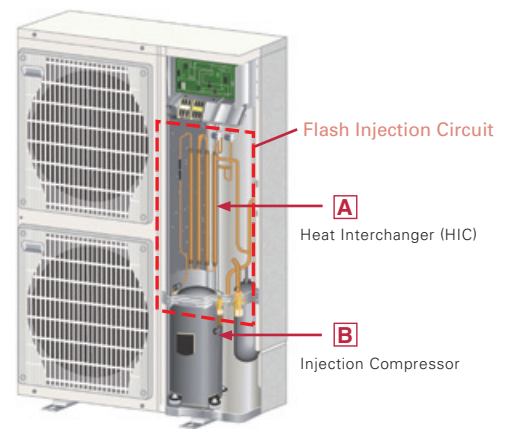
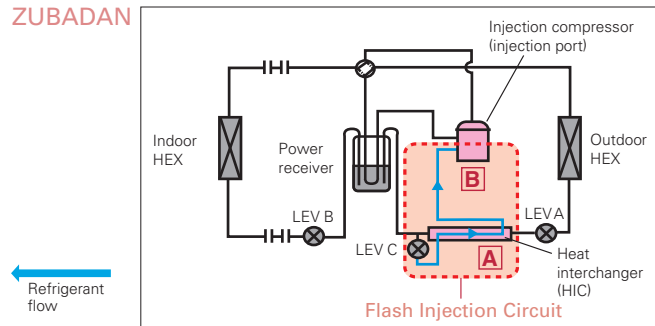

The ZUBADAN Series is equipped with Mitsubishi Electric's original Flash Injection Circuit, which is comprised of a bypass circuit and heat interchanger (HIC). The HIC transforms rerouted liquid refrigerant into a gas-liquid state to lower compression load. This process ensures excellent heating performance even when the outdoor temperature drops very low.

In traditional units, when the outdoor temperature is low, the volume of refrigerant circulating in the compressor decreases due to the drop in refrigerant pressure and the protection from overheating caused by high compression, thereby reducing heating capacity. The Flash Injection Circuit injects refrigerant to maintain the refrigerant circulation volume and compressor operation load, thereby maintaining heating capacity.

Mollier Chart Image Representing Flash Injection Circuit Operation

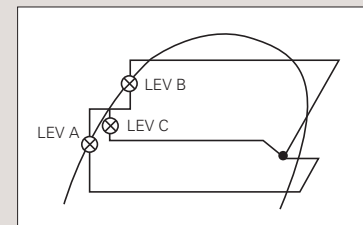

A Heat Interchanger (HIC)

HIC cross-sectional view

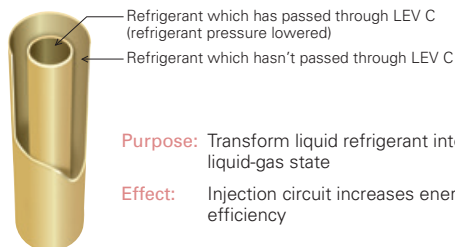

The compressor is subjected to a heavy load when compressing liquid refrigerant, and the result is lower operation efficiency. The addition of HIC supports refrigerant heat exchange at two different pressure levels. The heat-exchange process transforms the injected liquid refrigerant into a gas liquid state, thereby decreasing the load on the compressor during the compression process.

B Injection Compressor

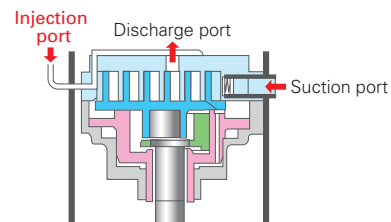

Purpose: To increase the volume of refrigerant being circulated
Effect: Improves heating capacity at low outdoor temperatures, and enables higher indoor-air outlet temperature adjustment and higher defrost operation speed

Refrigerant passes from the HIC into the compressor through the injection port. Having two refrigerant inlets makes it possible to raise the volume of refrigerant being circulated when the outdoor temperature is low and at the start of heating operation.

PLZ-SHW SERIES



Indoor Unit

R32
R410A



PLA-ZM100/125EA

Panel

Panel	With Signal Receiver	With 3D i-see Sensor	With Wireless Remote Controller	With Auto Elevation
PLP-6EA				
PLP-6EAL	✓			
PLP-6EAE		✓		
PLP-6EAL	✓	✓		
PLP-6EAL	✓			✓
PLP-6EAL	✓	✓		✓
PLP-6EALM	✓		✓	
PLP-6EALME	✓	✓	✓	

Outdoor Unit

R410A

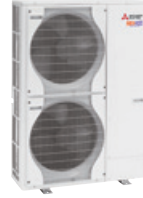

PUHZ-SHW112VHA(-BS)
PUHZ-SHW112/140YHA(-BS)

Remote Controller



Enclosed in
PLP-6EALM/PLP-6EALME



*optional



*optional



*optional



Type	Inverter Heat Pump					
Indoor Unit	PLA-ZM100EA		PLA-ZM125EA			
Outdoor Unit	PUHZ-SHW112VHA	PUHZ-SHW112YHA	PUHZ-SHW140YHA			
Refrigerant	R410A*1					
Power Supply	Outdoor power supply					
Outdoor (V/Phase/Hz)	230 / 1 / 50	400 / 3 / 50	400 / 3 / 50			
Cooling	Capacity	Rated	kW	10.0	10.0	12.5
		Min - Max	kW	4.9 - 11.4	4.9 - 11.4	5.5 - 14.0
	Total Input	Rated	kW	2.857	2.857	5.000
	EER			-	-	2.50
		EEL Rank		-	-	-
	Design Load		kW	10.0	10.0	-
	Annual Electricity Consumption*2		kWh/a	633	633	-
	SEER			5.5	5.5	-
		Energy Efficiency Class		A	A	-
Heating (Average Season)	Capacity	Rated	kW	11.2	11.2	14.0
		Min - Max	kW	4.5 - 14.0	4.5 - 14.0	5.0 - 16.0
	Total Input	Rated	kW	2.667	2.667	4.000
	COP			-	-	3.50
		EEL Rank		-	-	-
	Design Load		kW	12.7	12.7	-
	Declared Capacity	at reference design temperature	kW	11.2 (-10°C)	11.2 (-10°C)	-
		at bivalent temperature	kW	11.2 (-7°C)	11.2 (-7°C)	-
		at operation limit temperature	kW	9.3 (-25°C)	9.3 (-25°C)	-
	Back Up Heating Capacity		kW	1.5	1.5	-
Annual Electricity Consumption*2		kWh/a	4420	4420	-	
SCOP			4.0	4.0	-	
	Energy Efficiency Class		A+	A+	-	
Operating Current (max)		A	35.5	13.5	13.5	
Indoor Unit	Input	Rated	kW	0.07	0.07	0.08
	Operating Current (max)		A	0.47	0.47	0.52
	Dimensions <Panel>	H x W x D	mm	298-840-840 <40-950-950>		
	Weight <Panel>		kg	26 <5>	26 <5>	26 <5>
	Air Volume [Lo-Mi2-Mi1-Hi]		m³/min	19 - 22 - 25 - 28	19 - 22 - 25 - 28	21 - 24 - 26 - 29
	Sound Level (SPL) [Lo-Mi2-Mi1-Hi]		dB(A)	31 - 34 - 37 - 40	31 - 34 - 37 - 40	33 - 36 - 39 - 41
	Sound Level (PWL)		dB(A)	61	61	62
Outdoor Unit	Dimensions	H x W x D	mm	1350 - 950 - 330 (+30)		
	Weight		kg	120	134	134
	Air Volume	Cooling	m³/min	100	100	100
		Heating	m³/min	100	100	100
	Sound Level (SPL)	Cooling	dB(A)	51	51	51
		Heating	dB(A)	52	52	52
	Sound Level (PWL)	Cooling	dB(A)	69	69	69
	Operating Current (max)		A	35	13	13
	Breaker Size		A	40	16	16
	Ext. Piping	Diameter	Liquid / Gas	mm	9.52 / 15.88	
Max. Length		Out-In	m	75		
Max. Height		Out-In	m	30		
Guaranteed Operating Range [Outdoor]	Cooling*3	°C	-15 ~ +46			
	Heating	°C	-25 ~ +21			

*1 Refrigerant leakage contributes to climate change. Refrigerant with lower global warming potential (GWP) would contribute less to global warming than a refrigerant with higher GWP, if leaked to the atmosphere. This appliance contains a refrigerant fluid with a GWP equal to 1975. This means that if 1kg of this refrigerant fluid would be leaked to the atmosphere, the impact on global warming would be 1975 times higher than 1kg of CO₂ over a period of 100 years. Never try to interfere with the refrigerant circuit yourself or disassemble the product yourself and always ask a professional.

*2 Energy consumption based on standard test results. Actual energy consumption will depend on how the appliance is used and where it is located.

*3 Optional air protection guide is required where ambient temperature is lower than -5°C.

PLZ-SHW SERIES



Indoor Unit

R410A



PLA-M100/125EA

Panel

Panel	With Signal Receiver	With 3D i-see Sensor	With Wireless Remote Controller	With Auto Elevation
PLP-6EA				
PLP-6EAL	✓			
PLP-6EAE		✓		
PLP-6EAJE	✓	✓		
PLP-6EAJ	✓			✓
PLP-6EAJE	✓	✓		✓
PLP-6EALM	✓		✓	
PLP-6EALME	✓	✓	✓	

Outdoor Unit

R410A

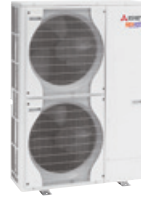

PUHZ-SHW112VHA (-BS)
PUHZ-SHW112/140YHA (-BS)

Remote Controller



Enclosed in
PLP-6EALM/PLP-6EALME



*optional



*optional



*optional



Type	Inverter Heat Pump					
Indoor Unit	PLA-M100EA		PLA-M125EA			
Outdoor Unit	PUHZ-SHW112VHA	PUHZ-SHW112YHA	PUHZ-SHW140YHA			
Refrigerant	R410A*1					
Power Supply	Outdoor power supply					
	230 / 1 / 50	400 / 3 / 50	400 / 3 / 50			
Cooling	Capacity	Rated	kW	10.0	10.0	12.5
		Min - Max	kW	4.9 - 11.4	4.9 - 11.4	5.5 - 14.0
	Total Input	Rated	kW	2.940	2.940	5.000
	EER			-	-	2.50
		EEL Rank		-	-	-
	Design Load		kW	10.0	10.0	-
	Annual Electricity Consumption*2		kWh/a	661	661	-
Heating (Average Season)	SEER			5.3	5.3	-
		Energy Efficiency Class		A	A	-
	Capacity	Rated	kW	11.2	11.2	14.0
		Min - Max	kW	4.5 - 14.0	4.5 - 14.0	5.0 - 16.0
	Total Input	Rated	kW	2.793	2.793	4.000
	COP			-	-	3.50
		EEL Rank		-	-	-
Operating Current (max)	Design Load		kW	12.7	12.7	-
	Declared Capacity	at reference design temperature	kW	11.2 (-10°C)	11.2 (-10°C)	-
		at bivalent temperature	kW	11.2 (-7°C)	11.2 (-7°C)	-
		at operation limit temperature	kW	9.3 (-25°C)	9.3 (-25°C)	-
		Back Up Heating Capacity		kW	1.5	1.5
	Annual Electricity Consumption*2		kWh/a	4445	4445	-
	SCOP			4.0	4.0	-
	Energy Efficiency Class		A+	A+	-	
Indoor Unit	Input	Rated	kW	0.07	0.07	0.08
	Operating Current (max)		A	0.46	0.46	0.66
	Dimensions <Panel>	H x W x D	mm	298-840-840 <40-950-950>		
	Weight <Panel>		kg	24 <5>	24 <5>	26 <5>
	Air Volume [Lo-Mi2-Mi1-Hi]		m³/min	19 - 23 - 26 - 29	19 - 23 - 26 - 29	21 - 25 - 28 - 31
	Sound Level (SPL) [Lo-Mi2-Mi1-Hi]		dB(A)	31 - 34 - 37 - 40	31 - 34 - 37 - 40	33 - 37 - 41 - 44
	Sound Level (PWL)		dB(A)	61	61	65
Outdoor Unit	Dimensions	H x W x D	mm	1350 - 950 - 330 (+30)		
	Weight		kg	120	134	134
	Air Volume	Cooling	m³/min	100	100	100
		Heating	m³/min	100	100	100
	Sound Level (SPL)	Cooling	dB(A)	51	51	51
		Heating	dB(A)	52	52	52
	Sound Level (PWL)	Cooling	dB(A)	69	69	69
Operating Current (max)		A	35	13	13	
Breaker Size		A	40	16	16	
Ext. Piping	Diameter	Liquid / Gas	mm	9.52 / 15.88		
	Max. Length	Out-In	m	75		
	Max. Height	Out-In	m	30		
Guaranteed Operating Range [Outdoor]	Cooling*3	°C	-15 ~ +46			
	Heating	°C	-25 ~ +21			

*1 Refrigerant leakage contributes to climate change. Refrigerant with lower global warming potential (GWP) would contribute less to global warming than a refrigerant with higher GWP, if leaked to the atmosphere. This appliance contains a refrigerant fluid with a GWP equal to 1975. This means that if 1kg of this refrigerant fluid would be leaked to the atmosphere, the impact on global warming would be 1975 times higher than 1kg of CO₂ over a period of 100 years. Never try to interfere with the refrigerant circuit yourself or disassemble the product yourself and always ask a professional.

*2 Energy consumption based on standard test results. Actual energy consumption will depend on how the appliance is used and where it is located.

*3 Optional air protection guide is required where ambient temperature is lower than -5°C.

PEDZ-SHW JA SERIES



Indoor Unit

R32
R410A



PEAD-M100/125JA(L)

Outdoor Unit

R410A

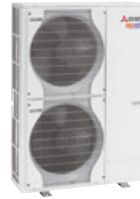

PUAZ-SHW112VHA(-BS)
PUAZ-SHW112/140YHA(-BS)

Remote Controller



*optional



*optional



*optional



*optional



Type			Inverter Heat Pump			
Indoor Unit			PEAD-M100JA(L)			
Outdoor Unit			PUAZ-SHW112VHA(-BS)	PUAZ-SHW112YHA(-BS)	PEAD-M125JA(L)	
Refrigerant			R410A*1			
Power Supply			Outdoor power supply			
Source			VHA:230 / Single / 50, YHA:400 / Three / 50			
Outdoor (V/Phase/Hz)						
Cooling	Capacity	Rated	kW	10.0	10.0	12.5
		Min - Max	kW	4.9 - 11.4	4.9 - 11.4	5.5 - 14.0
	Total Input	Rated	kW	2.924 (2.904)	2.924 (2.904)	3.895 (3.875)
	EER			-	-	3.21 (3.22)
		EEL Rank		-	-	-
	Design Load		kW	10.0	10.0	-
	Annual Electricity Consumption*2		kWh/a	729 (714)	729 (714)	-
	SEER			4.8 (4.9)	4.8 (4.9)	-
Energy Efficiency Class			B			
Heating (Average Season)	Capacity	Rated	kW	11.2	11.2	14.0
		Min - Max	kW	4.5 - 14.0	4.5 - 14.0	5.0 - 16.0
	Total Input	Rated	kW	3.103	3.103	3.879
	COP			-	-	3.61
		EEL Rank		-	-	-
	Design Load		kW	12.7	12.7	-
	Declared Capacity	at reference design temperature	kW	11.2	11.2	-
		at bivalent temperature	kW	11.2	11.2	-
		at operation limit temperature	kW	9.4	9.4	-
	Back Up Heating Capacity		kW	1.5	1.5	-
Annual Electricity Consumption*2		kWh/a	4664	4664	-	
SCOP			3.8	3.8	-	
Energy Efficiency Class			A			
Operating Current (max)			A			
			37.7			
Indoor Unit	Input [Cooling / Heating]	Rated	kW	0.25 (0.23) / 0.23	0.25 (0.23) / 0.23	0.36 (0.34) / 0.34
		Operating Current (max)	A	2.65	2.65	2.76
	Dimensions	H x W x D	mm	250 - 1400 - 732		
	Weight		kg	41 (40)	41 (40)	43 (42)
	Air Volume [Lo-Mid-Hi]		m ³ /min	24.0 - 29.0 - 34.0	24.0 - 29.0 - 34.0	29.5 - 35.5 - 42.0
	External Static Pressure		Pa	35 / 50 / 70 / 100 / 150	35 / 50 / 70 / 100 / 150	35 / 50 / 70 / 100 / 150
	Sound Level (SPL) [Lo-Mid-Hi]		dB(A)	29 - 34 - 38	29 - 34 - 38	33 - 36 - 40
	Sound Level (PWL)		dB(A)	61	61	65
Outdoor Unit	Dimensions	H x W x D	mm	1350 - 950 - 330 (+30)		
	Weight		kg	120	134	134
	Air Volume	Cooling	m ³ /min	100.0	100.0	100.0
		Heating	m ³ /min	100.0	100.0	100.0
	Sound Level (SPL)	Cooling	dB(A)	51	51	51
		Heating	dB(A)	52	52	52
	Sound Level (PWL)	Cooling	dB(A)	69	69	69
		Operating Current (max)		A	35.0	13.0
Breaker Size		A	40	16	16	
Ext. Piping	Diameter	Liquid / Gas	mm	9.52 / 15.88	9.52 / 15.88	9.52 / 15.88
	Max. Length	Out-In	m	75	75	75
	Max. Height	Out-In	m	30	30	30
Guaranteed Operating Range [Outdoor]	Cooling*3	°C	-15 ~ +46	-15 ~ +46	-15 ~ +46	
	Heating	°C	-25 ~ +21	-25 ~ +21	-25 ~ +21	

*1 Refrigerant leakage contributes to climate change. Refrigerant with lower global warming potential (GWP) would contribute less to global warming than a refrigerant with higher GWP, if leaked to the atmosphere. This appliance contains a refrigerant fluid with a GWP equal to 1975. This means that if 1 kg of this refrigerant fluid would be leaked to the atmosphere, the impact on global warming would be 1975 times higher than 1 kg of CO₂ over a period of 100 years. Never try to interfere with the refrigerant circuit yourself or disassemble the product yourself and always ask a professional.

*2 Energy consumption based on standard test results. Actual energy consumption will depend on how the appliance is used and where it is located.

*3 Optional air protection guide is required where ambient temperature is lower than -5°C.

PKZ-SHW SERIES



Indoor Unit

R32
R410A



PKA-M100KA(L)

Outdoor Unit

R410A



PUAH-SHW112VHA(-BS)
PUAH-SHW112/140YHA(-BS)

Remote Controller



*optional



*optional



*optional

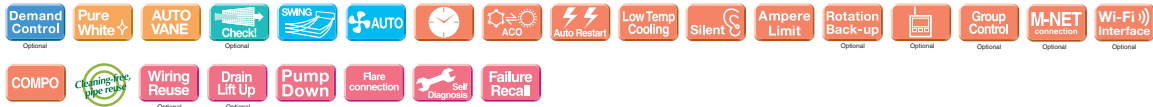

Type		Inverter Heat Pump				
Indoor Unit		PKA-M100KA(L)				
Outdoor Unit		PUAH-SHW112VHA(-BS)		PUAH-SHW112YHA(-BS)		
Refrigerant		R410A*1				
Power Supply		Outdoor power supply				
Outdoor (V/Phase/Hz)		VHA:230 / Single / 50, YHA:400 / Three / 50				
Cooling	Capacity	Rated	kW	10.0	10.0	
		Min - Max	kW	4.9 - 11.4	4.9 - 11.4	
	Total Input	Rated	kW	2.924	2.924	
	Design Load		kW	10.0	10.0	
	Annual Electricity Consumption*2		kWh/a	673	673	
	SEER			5.2	5.2	
		Energy Efficiency Class		A	A	
Heating (Average Season)	Capacity	Rated	kW	11.2	11.2	
		Min - Max	kW	4.5 - 14.0	4.5 - 14.0	
	Total Input	Rated	kW	3.103	3.103	
	Design Load		kW	12.7	12.7	
	Declared Capacity		at reference design temperature	kW	11.2	11.2
			at bivalent temperature	kW	11.2	11.2
			at operation limit temperature	kW	9.4	9.4
	Back Up Heating Capacity		kW	1.5	1.5	
	Annual Electricity Consumption*2		kWh/a	4664	4664	
	SCOP			3.8	3.8	
		Energy Efficiency Class		A	A	
Operating Current (max)			A	35.6	13.6	
Indoor Unit	Input	Rated	kW	0.08	0.08	
	Operating Current (max)		A	0.57	0.57	
	Dimensions <Panel>	H x W x D	mm	365 - 1170 - 295		
	Weight <Panel>		kg	21	21	
	Air Volume [Lo-Mid-Hi]		m ³ /min	20 - 23 - 26	20 - 23 - 26	
	Sound Level (SPL) [Lo-Mid-Hi]		dB(A)	41 - 45 - 49	41 - 45 - 49	
	Sound Level (PWL)		dB(A)	65	65	
Outdoor Unit	Dimensions	H x W x D	mm	1350 - 950 - 330 (+30)		
	Weight		kg	120	134	
	Air Volume	Cooling	m ³ /min	100.0	100.0	
		Heating	m ³ /min	100.0	100.0	
	Sound Level (SPL)	Cooling	dB(A)	51	51	
		Heating	dB(A)	52	52	
	Sound Level (PWL)	Cooling	dB(A)	69	69	
	Operating Current (max)		A	35.0	13.0	
	Breaker Size		A	40	16	
	Ext. Piping	Diameter	Liquid / Gas	mm	9.52 / 15.88	9.52 / 15.88
Max. Length		Out-In	m	75	75	
Max. Height		Out-In	m	30	30	
Guaranteed Operating Range (Outdoor)	Cooling*3		°C	-15 ~ +46	-15 ~ +46	
	Heating		°C	-25 ~ +21	-25 ~ +21	

*1 Refrigerant leakage contributes to climate change. Refrigerant with lower global warming potential (GWP) would contribute less to global warming than a refrigerant with higher GWP, if leaked to the atmosphere. This appliance contains a refrigerant fluid with a GWP equal to 1975. This means that if 1kg of this refrigerant fluid would be leaked to the atmosphere, the impact on global warming would be 1975 times higher than 1kg of CO₂ over a period of 100 years. Never try to interfere with the refrigerant circuit yourself or disassemble the product yourself and always ask a professional.

*2 Energy consumption based on standard test results. Actual energy consumption will depend on how the appliance is used and where it is located.

*3 Optional air protection guide is required where ambient temperature is lower than -5°C.

MXZ-VAHZ SERIES

New hyper-heating MXZ allows you to create an oasis of comfort throughout your home and office in the rooms you use most, any time of the year.



Standard rated heating capacity is maintained even when the outside-air temperature drops to -15°C .

Maintains high capacity output even when outside-air temperature is low.

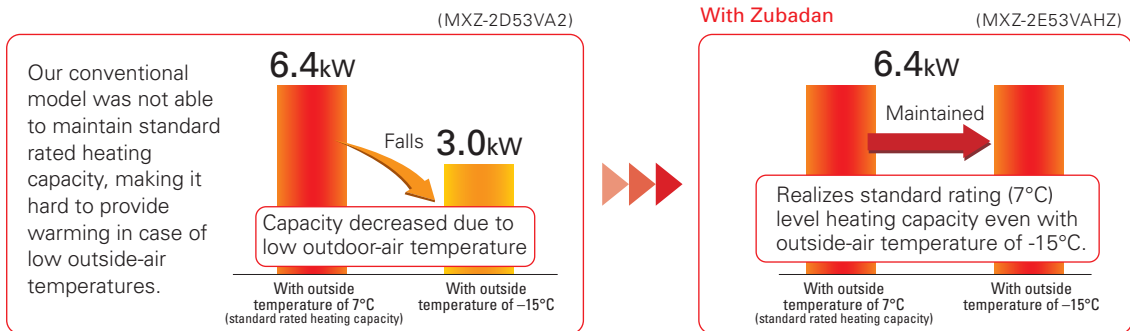

Can operate at outside-air temperature of -25°C

1. Incorporated key parts resistant to cold of up to -25°C after rigorous selection.
2. Printed circuit board-core of the air conditioner—is coated on both sides to protect it in harsh environments.

Freeze-prevention heater standard equipment

Prevents capacity loss and operation from stopping due to drain water freezing.

Drain water **freezes** after operation in the harsh cold



With Hyper heating Does not freeze!

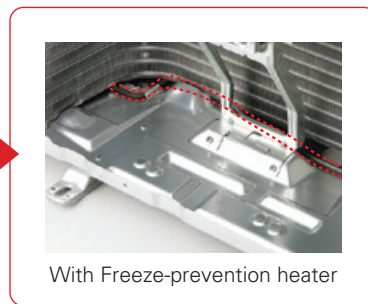

Continuous heating for long periods

Wasteful defrosting operation suppressed to enable more comfortable long-term continuous heating.

Extremely cold outside

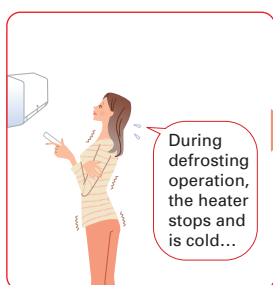

With Hyper heating

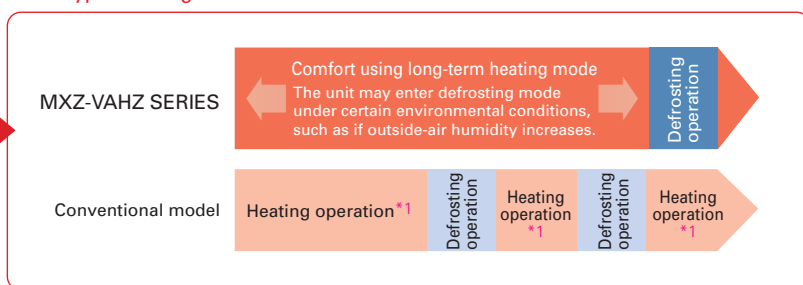

*1: Conventional model performs continuous heating approximately 30min up to a maximum of 90min.

One outdoor unit supports multiple indoor units.

With MXZ-VAHZ, one outdoor unit can cool and heat up to six rooms. They can be installed neatly in sites with limited space such as condominium balconies.

*Please note that cooling and heating modes cannot be run simultaneously in different rooms.

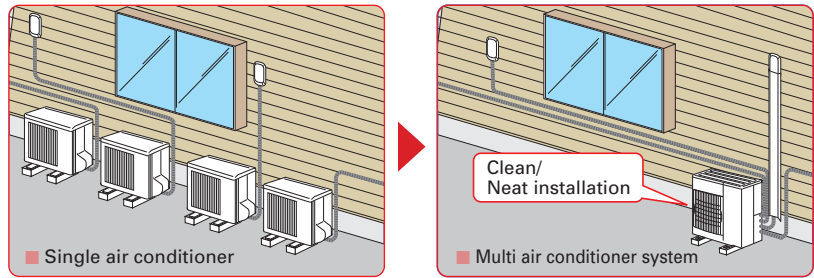

EXAMPLE SYSTEM

MXZ-4E83VAHZ system

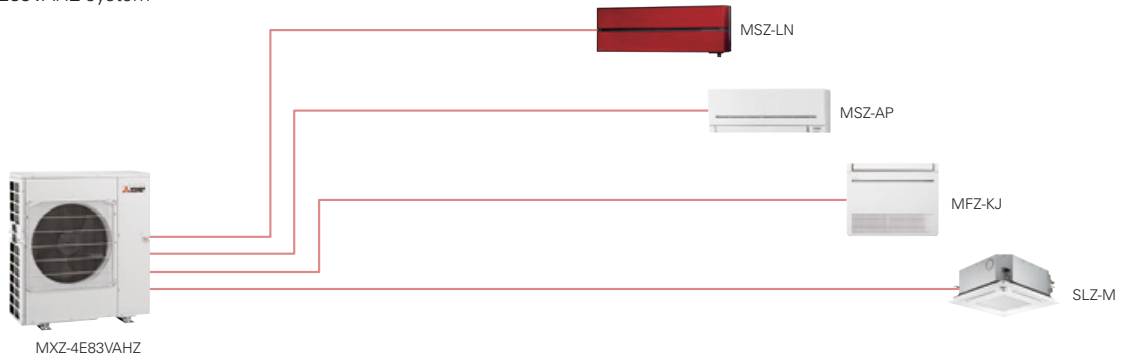

Freedom of combinations in cold region greatly enhanced

The variety of indoor unit connection options in cold regions, restricted until now, has been greatly increased. Increased design freedom.

OUTDOOR UNITS

2-room use



4-room use



INDOOR UNITS

Wall-mounted



Floor-standing



Cassette



Ceiling-suspended



Ceiling-concealed



*1: P series cannot be connect with MXZ-4E83VAHZ when ampere limit adjustment function is operated.

MXZ-VAHZ SERIES



Outdoor Unit

R410A



MXZ-2E53VAHZ

R410A



MXZ-4E83VAHZ

Type		Inverter Heat Pump				
Indoor Unit		Please refer to*4 *5				
Outdoor Unit		MXZ-2E53VAHZ		MXZ-4E83VAHZ		
Refrigerant		R410A*1				
Power Supply		Outdoor power supply				
Outdoor (V/Phase/Hz)		220 - 230 - 240V / Single / 50				
Cooling	Capacity	Rated	kW	5.3	8.3	
		Min - Max	kW	1.1 - 6.0	3.5 - 9.2	
	Total Input	Rated	kW	1.29	2.25	
	Design Load		kW	5.3	8.3	
	Annual Electricity Consumption*2		kWh/a	282	447	
	SEER*4			6.5	6.5	
		Energy Efficiency Class*4		A++	A++	
Heating (Average Season)	Capacity	Rated (7°C)	kW	6.4	9.0	
		Rated (-7°C)	kW	6.4	9.0	
		Rated (-15°C)	kW	6.4	9.0	
		Min - Max	kW	1.0 - 7.0	3.5 - 11.6	
	Total Input	Rated	kW	1.36	1.90	
	Design Load		kW	6.4	10.1	
	Declared Capacity	at reference design temperature	kW	6.4	9.0	
		at bivalent temperature	kW	6.4	9.0	
		at operation limit temperature	kW	2.4	2.5	
	Back Up Heating Capacity		kW	0.0	1.1	
Annual Electricity Consumption*2		kWh/a	2165	3446		
SCOP			4.1	4.1		
		Energy Efficiency Class*4		A+	A+	
Max. Operating Current (Indoor+Outdoor)			A	15.6	28.0	
Outdoor Unit	Dimensions	H x W x D	mm	796 x 950 x 330	1048 x 950 x 330	
	Weight		kg	61	87	
	Air Volume	Cooling		m ³ /min	47.0	63.0
		Heating		m ³ /min	47.0	77.0
	Sound Level (SPL)	Cooling		dB(A)	45	53
		Heating		dB(A)	47	57
	Sound Level (PWL)	Cooling		dB(A)	55	66
Breaker Size			A	16	30	
Ext. Piping	Diameter	Liquid / Gas	mm	6.35 x 2 / 9.52 x 2	6.35 x 4 / 12.7 x 1 + 9.52 x 3	
	Total Piping Length (max)		m	30	70	
	Each Indoor Unit Piping Length (max)		m	20	25	
	Max. Height		m	15 (10)*3	15 (10)*3	
	Chargeless Length		m	20	25	
Guaranteed Operating Range (Outdoor)	Cooling		°C	-10 ~ +46	-10 ~ +46	
	Heating		°C	-25 ~ +24	-25 ~ +24	

*1 Refrigerant leakage contributes to climate change. Refrigerant with lower global warming potential (GWP) would contribute less to global warming than a refrigerant with higher GWP, if leaked to the atmosphere. This appliance contains a refrigerant fluid with a GWP equal to 2088. This means that if 1 kg of this refrigerant fluid would be leaked to the atmosphere, the impact on global warming would be 2088 times higher than 1 kg of CO₂, over a period of 100 years. Never try to interfere with the refrigerant circuit yourself or disassemble the product yourself and always ask a professional.

*2 Energy consumption based on standard test results.

*3 Actual energy consumption will depend on how the appliance is used and where it is located.

*4 If the outdoor unit is installed higher than the indoor unit, max. height is reduced to 10m.

*5 EER/COP, EEL rank, SEER/SCOP values and energy efficiency class are measured when connected to the indoor units listed below.

MXZ-2E53VAHZ MSZ-EF18VE + MSZ-EF35VE
MXZ-4E83VAHZ MSZ-EF18VE + MSZ-EF18VE + MSZ-EF22VE + MSZ-EF25VE

*6 Indoor unit compatibility table is shown on page 112.

To ensure full capacity in cold and snowy regions...

3 Important Points to Remember When Installing the Outdoor Unit



* RAC/PAC (inc. Air to Water) /MXZ

Wind and snow can significantly reduce capacity. Be sure to check the information below and install the outdoor unit correctly.

1 Installation Location

Be aware of the prevailing wind direction in winter and install the outdoor unit where it is as sheltered as possible.

Units are easily affected by wind and unit may not be able to run at full capacity

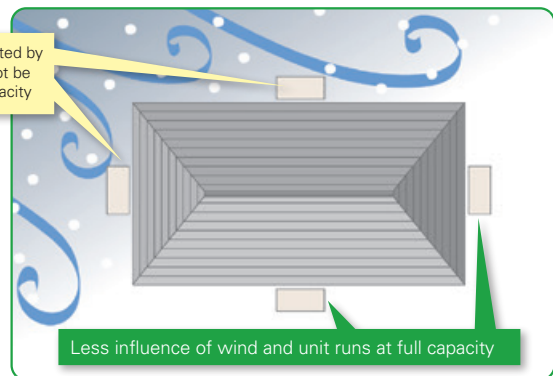

2 Measures for Drainage of Water

Case 1: Unit is installed close to passage (walkway)

Do not install the unit close to passage as drainage water from the unit may freeze and cause a slipping hazard.

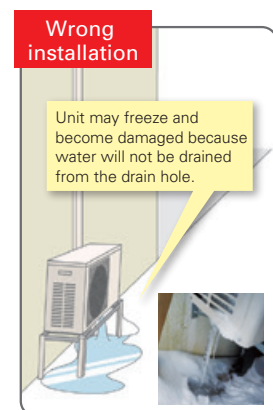
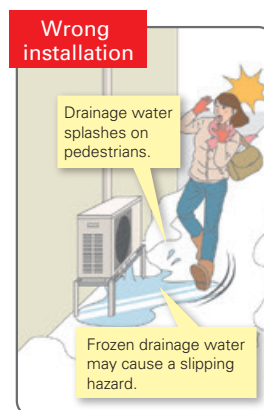
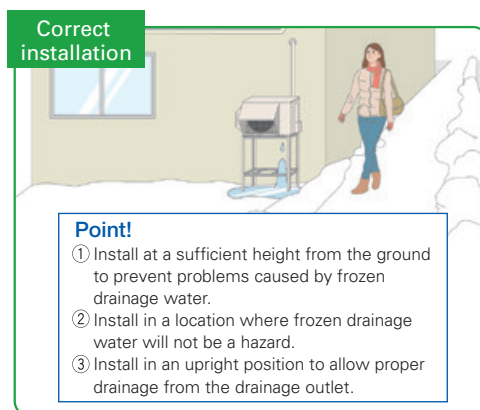

Case 2: Multiple units are installed

Do not install units on top of one another as it may cause frozen drainage water on the bottom unit.

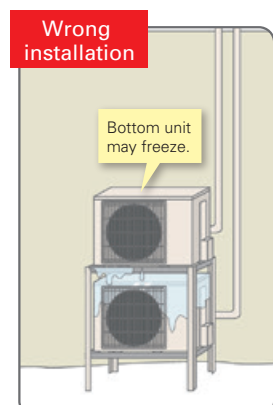
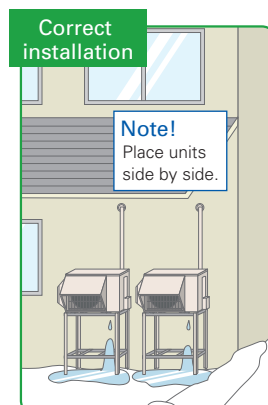

3

Measures for Snow

Unit is installed on the ground

To avoid the adverse effects of snow and frozen drainage water, install the unit on a stand to ensure a sufficient height from the ground.

[RAC / PAC / MXZ]

Correct installation



Point!

- ① Install at a position/height to prevent the unit being buried in snow*1 and the adverse effects of frozen drainage water.*2
 - ② Install so as to avoid the effects of snow or snowdrift.
 - ③ Install so as to avoid the damage from falling snow or icicles.
- *1 Install at a height above the highest snowfall depth.
*2 Even for correct installations, dripping drainage water may form an icicle which needs to be cleared away regularly to prevent a blocked drainage outlet.

Wrong installation

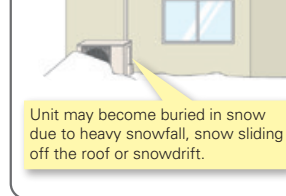

Wrong installation

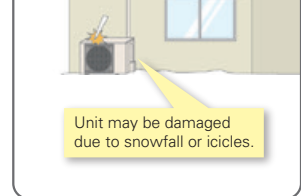

Use a stand to add sufficient height to protect the unit heat exchanger from snow and prevent icicles forming during defrost operation.

Install snow protection hood as necessary

[RAC / PAC / MXZ]

Correct installation

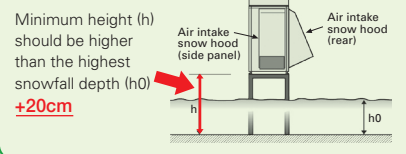

Wrong installation

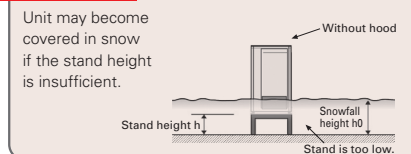

Correct installation

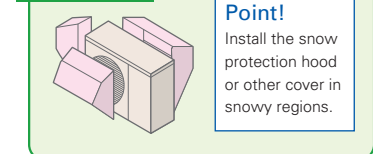

Necessity of accessories (drain socket & centralised drain pan, stand, snow protection hood, base heater)

	Snowy region	Cold region	Remarks
	Countermeasures for snow	Countermeasures for freezing	
Drain socket, Centralised drain pan	Not used	Not used	Prevents freezing
Stand	Needed	Needed	[RAC / PAC / MXZ] 1. Install so as to prevent the unit being buried in snow (at a height greater than the highest snowfall depth). Be sure that the stand does not obstruct drainage. 2. Install so as to prevent damage to the unit due to frozen drainage water (icicles).
Snow protection hood	Needed *When the installation position is subject to snowfall.	—	1. Prevents heat exchanger from being covered in snow. 2. Prevents snow accumulating inside the air duct.
Base heater	—	Needed	[RAC / PAC / MXZ] Outdoor units equipped with a heater for cold regions are those with an "H" in the model name. For the cold-climate zone, use of a unit with a heater is strongly recommended. Even for the moderate-climate zone use of a unit with a heater is recommended for regions subject to high humidity in winter.

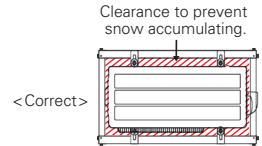

CAUTION

About disposal of drainage water

When the unit is installed in cold or snowy regions :

Drainage water may freeze in the drain socket/hose and prevent the fan from rotating.



Do not attach a drain socket packaged as an accessory to the unit.

* In the case that fitting a drain socket is absolutely necessary, steps must be taken so that the drainage water does not freeze. For more information, please consult Mitsubishi Electric or one of its dealers/resellers.

Arrangement for snow protection hood

[RAC / PAC / MXZ]
Separately sold parts are available for some models. Please consult Mitsubishi Electric or one of its dealers/resellers at the time of purchase for details.

AIR TO WATER



“ecodan” can heat rooms and supply domestic hot water, realising greater comfort and energy saving.

“ecodan” – Economic, eco conscious next generation heating system

Both energy-saving and safe for the environment, the Mitsubishi Electric ecodan incorporates a highly efficient heat pump system that captures “the heat in the air”, a renewable energy resource. Equipped with advanced inverter control, meticulous temperature control assures comfortable heating, and its space-saving “All-in-one” indoor unit is easy to install. These energy-saving, high comfort and simple installation characteristics have drawn the ecodan heating system into the spotlight centre stage.

Excellent ecodan’s heating performance, even at low outdoor temperature!

INDOOR UNIT















Hydro box, cylinder unit



Reversible hydro box, Reversible cylinder unit

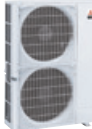

OUTDOOR UNIT

Packaged type	Small capacity (Under 5kW)*	Medium capacity (6.0kW–14kW)*	Large capacity (≥16kW)*
ZUBADAN		 PUHZ-HW112/140	
POWER INVERTER	 PUHZ-W50	  	
Split type	Small capacity (Under 5kW)*	Medium capacity (7.5kW–14kW)*	Large capacity (≥16kW)*
ZUBADAN New Generation		  	
POWER INVERTER	 PUHZ-SW50	   	
Eco Inverter	 SUHZ-SW45		
ATA/ATW Hybrid system	Small capacity (Under 5kW)*	Medium capacity (7.5kW–14kW)*	Large capacity (≥16kW)*
Mr.SLIM+		 PUHZ-FRP71	
PUMY + ecodan		 PUMY-P112/125/140	

*Rated capacity is at conditions A2W35. (according to EN14511)

New eco-design directive

What is the ErP Directive?

The Ecodesign Directive for Energy-related Products (ErP Directive) established a framework to set mandatory standards for ErPs sold in the European Union (EU). The ErP Directive introduces new energy efficiency ratings across various product categories. It affects how products such as computers, vacuum cleaners, boilers and even windows are classified in terms of environmental performance. Labelling regulations that apply to our ATW heat pumps came into effect from September 26, 2015.

New energy label and measurements

Under directive 2009/125/EC, ATW heat pumps of up to 70kW are required to show their heating efficiency on the energy label. The purpose of the energy label is to inform customers about the energy efficiency of a heating unit. The efficiency for space heating is ranked from A⁺⁺⁺ to G. In the case of domestic hot water, it is from A to G.

A package label is also required if the ecodan heat pump is installed with a controller and/or a solar system or additional heater. All ecodan units* are already rated as A⁺⁺⁺ for heating at both 55°C and 35°C and A for domestic hot water, which are the highest efficiency ranks.

*Except for our ATA/ATW hybrid system Mr.SLIM+

Product label

This label is for individual heating units, such as an ecodan heat pump. Typically, the space heater label is used for ecodan systems with a hydro box, and the combination heater label is used for ecodan systems with a cylinder unit.

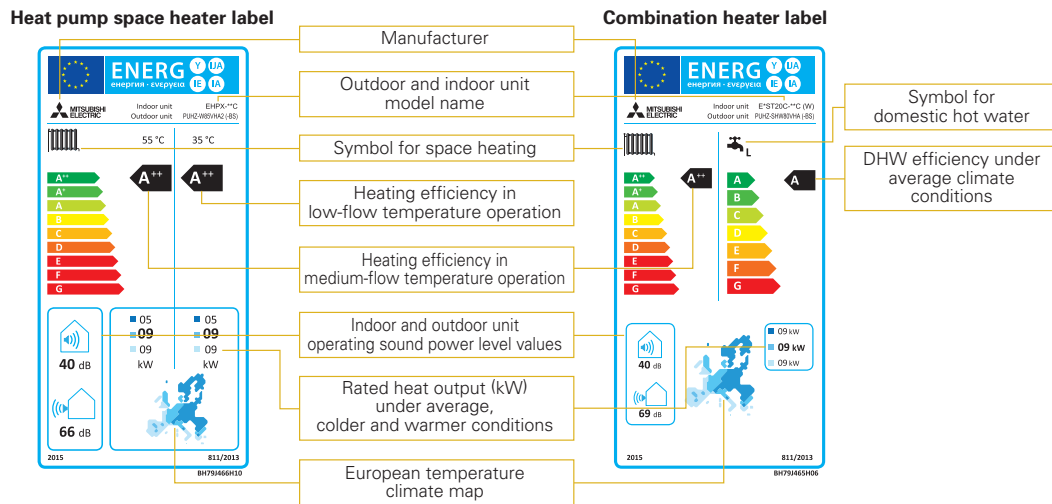

These labels are delivered with all ecodan outdoor units.

What is the package label?

A heating system can use several energy-related products, such as a controller or solar thermal system. Therefore, a label showing the efficiency of the total heating system is required. The category range is defined from A⁺⁺⁺ to G.

Creating the package label is the responsibility of the installers and distributors. A useful tool on the Mitsubishi Electric website is available to easily create the labels for ecodan products and controllers.

<http://erp.mitsubishielectric.eu/erp/options>

Package label

This label is for heating systems that use several energy-related products, such as a controller or a solar thermal system.

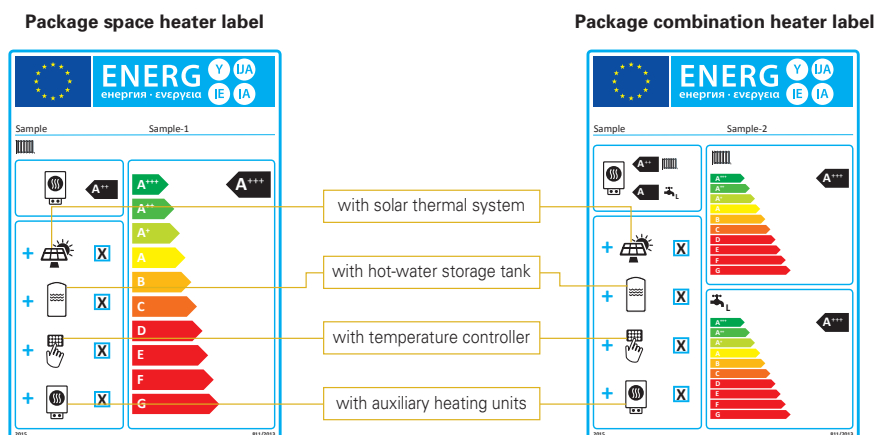

Customised package labels including ecodan heat pumps and the FTC5 controller can be created on the Mitsubishi Electric website.

Designed for Optimal Heating

ZUBADAN New Generation (Split type)

Even at the very low ambient temperatures, our ZUBADAN can provide powerful heating.



- Our unique flash injection circuit enables the nominal capacity to be maintained down to -15°C.
- The guaranteed operating range of the heating mode is extended down to -28°C.

Improved Heating Performance

Mitsubishi Electric's unique "Flash Injection" circuit achieves remarkably high heating performance. This technology has resulted in an excellent heating capacity rating in outdoor temperatures as low as -15°C, and the guaranteed heating operation range of the heating mode has been extended to -28°C. Accordingly, the heat-pump units of the ZUBADAN Series are perfect for warming homes in the coldest regions.

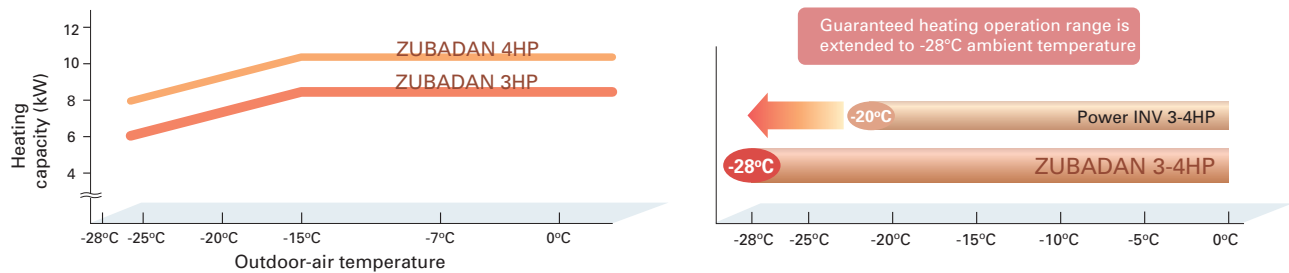

Mitsubishi Electric's Flash Injection Technology The Key to High Heating Performance at Low Outdoor Temperatures

Flash Injection Circuit

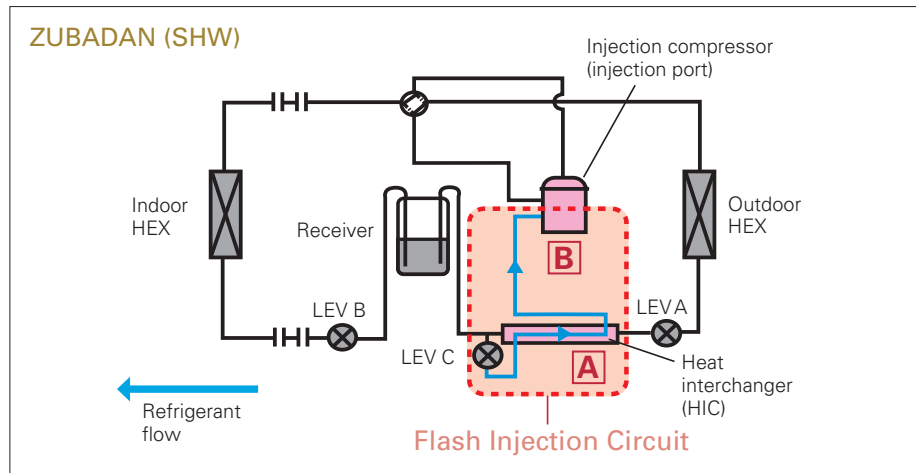

A Heat Interchanger (HIC)

HIC cross-sectional view

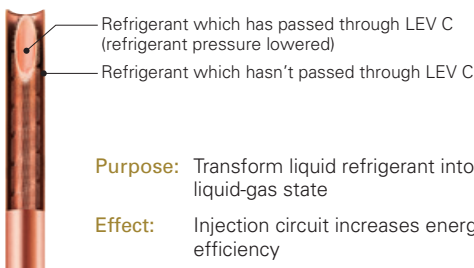

The compressor is subjected to a heavy load when compressing liquid refrigerant, and the result is lower operation efficiency. The addition of HIC supports refrigerant heat exchange at two different pressure levels. The heat-exchange process transforms the injected liquid refrigerant into a gas liquid state, thereby decreasing the load on the compressor during the compression process.

B Injection Compressor

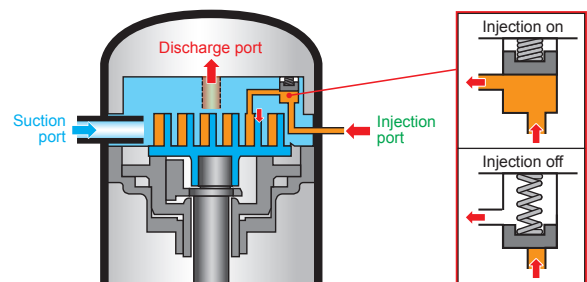

Purpose: To increase the volume of refrigerant being circulated

Effect: Improves heating capacity at low outdoor temperatures, and enables higher outlet temperature adjustment and higher defrost operation speed

Refrigerant passes from the HIC into the compressor through the injection port. Having two refrigerant inlets makes it possible to raise the volume of refrigerant being circulated when the outdoor temperature is low and at the start of heating operation.

Dedicated Heat Pump for Residence

PUHZ-SW75V/YAA SW100V/YAA SHW80V/YAA SHW112V/YAA
W60VAA W85V/YAA W112V/YAA

Stylish and compact



The stylish design and compact size harmonises residential application

- Simple and elegant design by rounding left and right corners of the unit.
- Concealing the fan by matching the panel and the grille in dark colour.
- Unified shape and safety by setting the fan whole backwards and matching the grille on the same level of the front panel.

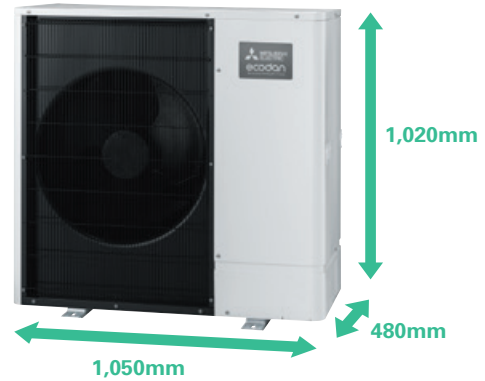

High performance

New compressor



- Compact
- High performance

* for PUHZ-SW100V/YAA
PUHZ-SHW80V/YAA
PUHZ-SHW112V/YAA
PUHZ-W112V/YAA

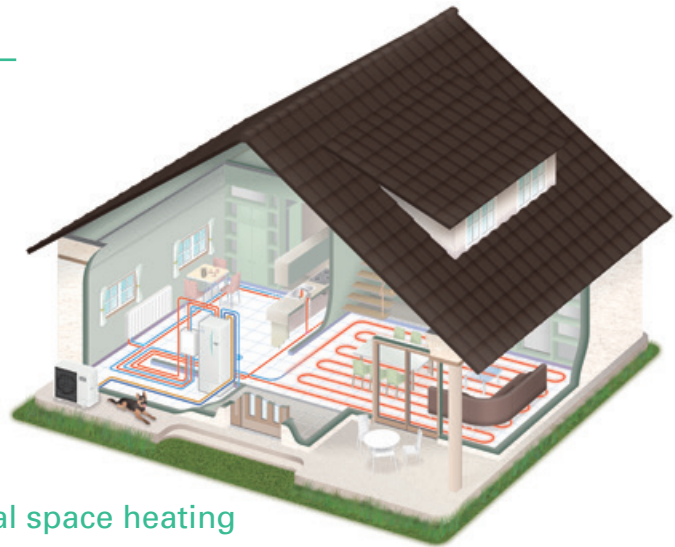

ErP Lot 1 Compliant with highest seasonal space heating energy efficiency class A++

Powerful heating yet annually high energy efficiency, achieving rank A++.

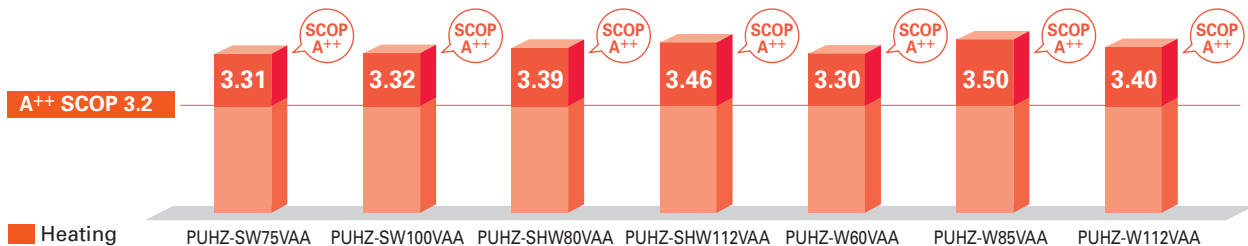

Higher reliability

New base design

Improving drainage

- Optimising the base structure to improve drainage.
- A slope of the base achieves smooth and faster drainage.



sectional view

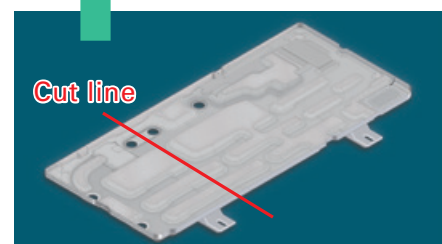

Optimizing defrost control and operation.
Optimizing outdoor unit heat exchanger to avoid ice-forming.

Compact but low noise

Noise reduction-10dB(A)

10dB(A) less in PWL comparing with the current models (of 3-4HP).

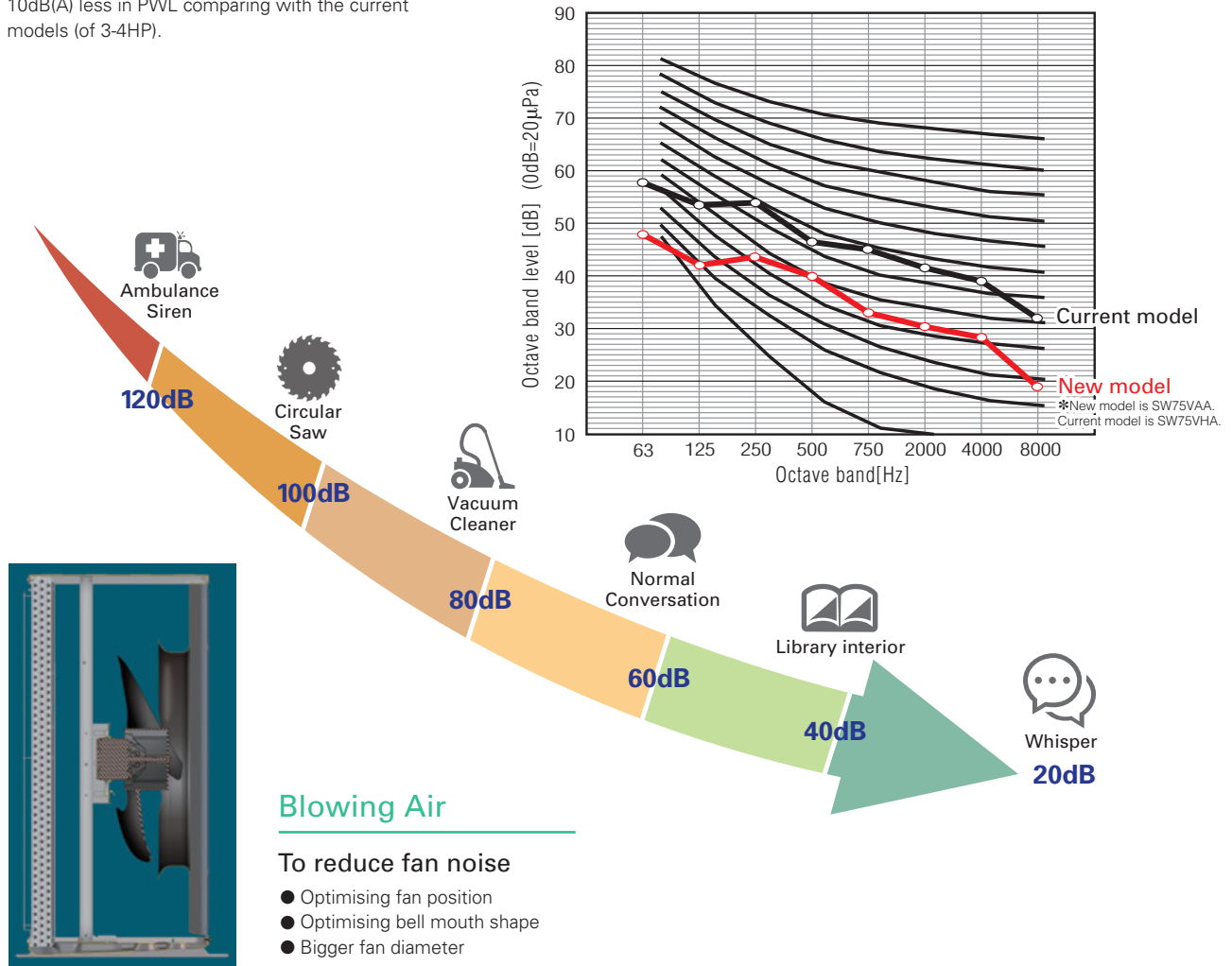

Enclosing noise

Shutting out noise from compressor

- The structure of double enclosing

Primary: enclosing a compressor (the structure is patented.)
 Secondary: enclosing machine room.



Avoiding vibration and resonance

- Dedicated soft rubber mount for the compressor to avoid vibration.
- Optimising piping structure to avoid vibration and resonance.

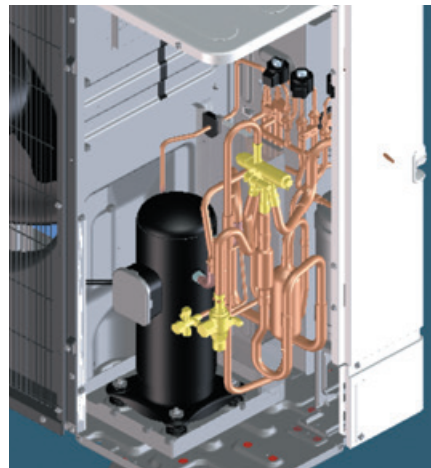

Indoor units

New all-in-one compact indoor unit

Easy to install and low maintenance

- All-in-one: Key functional components are incorporated
- Compact cylinder unit: Just 1600mm in height
- Compact hydro box: Only 530x360mm footprint
- Easy installation: Factory fitted pressure relief valve
- Easy service: Relevant parts are located at the front of the unit for easy maintenance
- Easy transport: Handles attached on front and back (cylinder unit)

Hydro box (Split type)

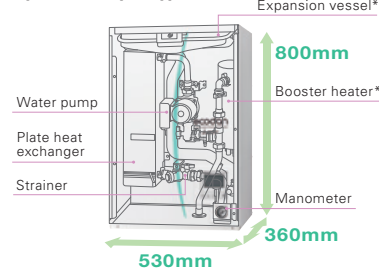

Cylinder unit (Split type)

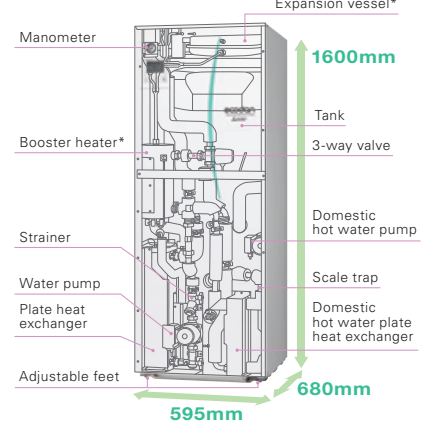

*Depending on model

Larger capacity system



Outdoor units

PUHZ-SW160/200YKA
SHW230YKA2

Indoor units

EHSE-YM9EC, EHSE-MEC, ERSE-YM9EC, ERSE-MEC

Our 8–10HP ecodan heat pumps, only available with a hydro box connection, are suitable for large houses and small businesses where a high heating load is necessary. Our latest generation of 8–10HP Power Inverter outdoor units can reach 60°C maximum flow temperature. The new 8–10HP hydro box is available in both heating only and reversible models and can be connected to a customised capacity domestic hot water tank.

Line-up

ecodan's line-up has many types of indoor units to satisfy diverse customers' needs, requests and local regulations. It includes smaller capacity units, with/without booster heater, with/without an expansion vessel, etc. In addition, a reversible hydro box and a reversible cylinder are available.

Hydro box



Cylinder unit



Reversible models (for heating/cooling)

Perfect comfort in winter and summer time, thanks to our reversible models.

Reversible models are now available for both hydro box and cylinder units (Split type only).

The new reversible cylinder is now able to produce cold water for cooling use and can alternatively produce domestic hot water in summer time.

Reversible hydro box



Reversible cylinder unit



Available options

- Packaged or Split type
- With/without booster heater
- With/without expansion vessel
- Cylinder unit has an integrated 200L stainless steel tank
- Hydro box is control ready for domestic hot water with a stand-alone tank (locally supplied)

*Reversible cylinder requires the installation of the drain pan stand PAC-DP01-E.

High-performance for domestic hot water re-charge

External plate heat exchanger – more energy savings using ecodan’s unique and innovative technologies

Save energy in domestic hot water operations

Thanks to an external plate heat exchanger, ecodan offers much higher domestic hot water efficiency. Compared to our previous model, domestic hot water recharge efficiency is improved by approximately 17%*1, thereby reducing operating costs.

Avoid performance loss due to scale

A scale trap is incorporated after the plate heat exchanger to capture calcium scale particles, thus maintaining the high performance of the external plate heat exchanger. (Just a 3% reduction during 15 years*2).

Lighter weight

Compared to our previous model, the cylinder unit is up to 15kg lighter*. This is thanks to the coil incorporated in the tank which has been removed and replaced by a much lighter plate heat exchanger.

*Comparison between EHST20C-VM2C and EHST20C-VM2B.

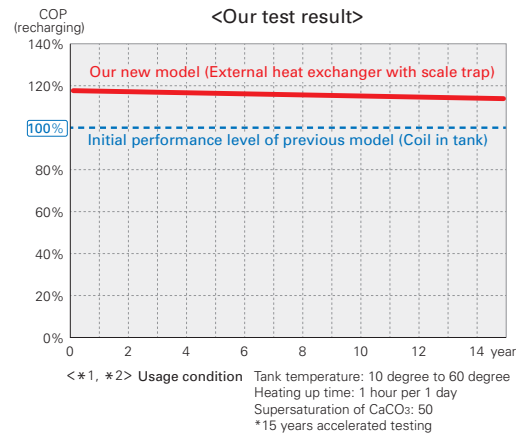

Optimised stratification for better comfort

Thanks to the L-shaped inlet pipe from the plate heat exchanger, stratification is well maintained after re-charge. You do not need to worry about running out of hot water the same as with a conventional coil in tank. Supply water temperature can be kept high until all the hot water in the tank has been used.

The secret behind our external plate heat exchanger system

Thanks to the unique plate heat exchanger and scale trap technology, a more efficient performance is achieved. In conventional systems, there is a risk of calcium scale building up on the heat-exchange plate if it is exposed to tap water directly. Therefore, it is difficult to use plate-based heat exchangers to heat tap water. To resolve this problem, ecodan is equipped with a “scale trap” that catches homogeneous calcium nuclei in the tap water before it has a chance to grow into large scales, thereby inhibiting build-up in the external heat exchanger. ecodan can use a plate heat exchanger to heat tap water, resulting in much higher domestic hot water performance.

Notice: In the case of special localised conditions such as very hard tap water, please consult a specialist before installation.

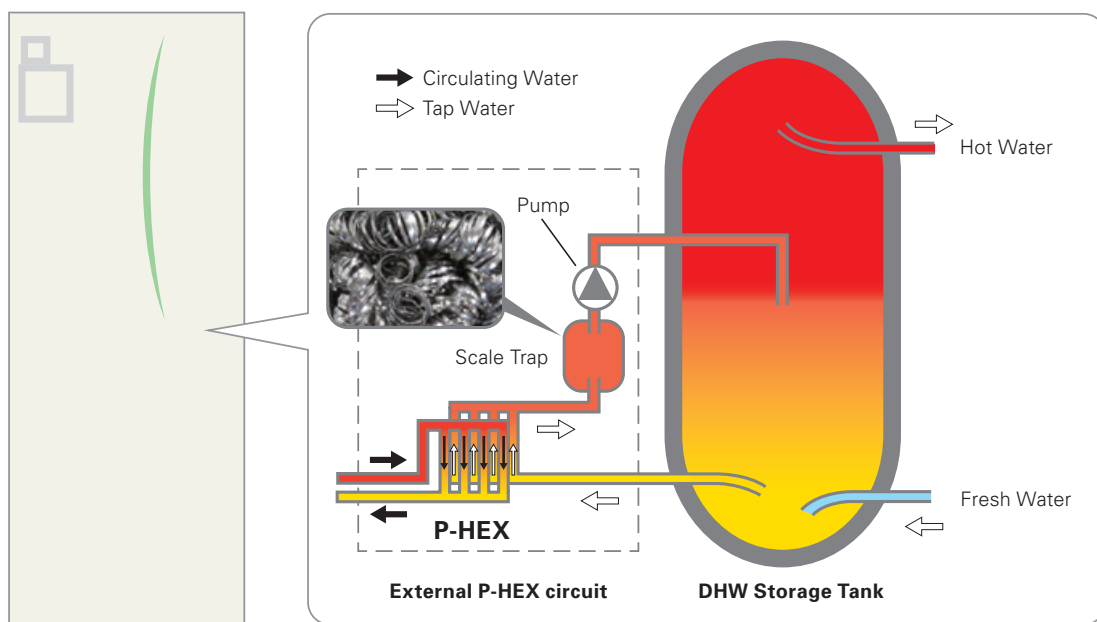

Unique technology of ecodan

Auto Adaptation

Maximise energy savings while retaining comfort at all times



*SD logo is a trademark of SD-3C, LLC

Regarding the relation of flow temperature and unit performance, a 1°C drop in the flow temperature improves the coefficient of performance (COP) of the ATW system by 2%. This means that energy savings are dramatically affected by controlling the flow temperature in the system.

In a conventional system controller, the flow temperature is determined based on the pre-set heat curve depending on the actual outdoor temperature. However, this requires a complicated setting to achieve the optimal heat curve.

Heat curve setting (Example)

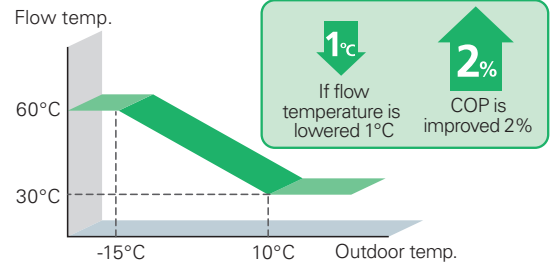

Mitsubishi Electric's Auto Adaptation function automatically tracks changes in the actual room temperature and outdoor temperature and adjusts the flow temperature accordingly.

Aiming to realise further comfort and energy savings, Mitsubishi Electric is proud to introduce a revolutionary new controller. Our advanced Auto Adaptation function measures the room temperature and outdoor temperature, and then calculates the required heating capacity for the room. Simply stated, the flow temperature is automatically controlled according to the required heating capacity, while optimal room temperature is maintained at all times, ensuring the appropriate heating capacity and preventing energy from being wasted. Furthermore, by estimating future changes in room temperature, the system works to prevent unnecessary increases and decreases in the flow temperature. Accordingly, Auto Adaptation maximises both comfort and energy savings without the need for complicated settings.

Future room temperature estimation

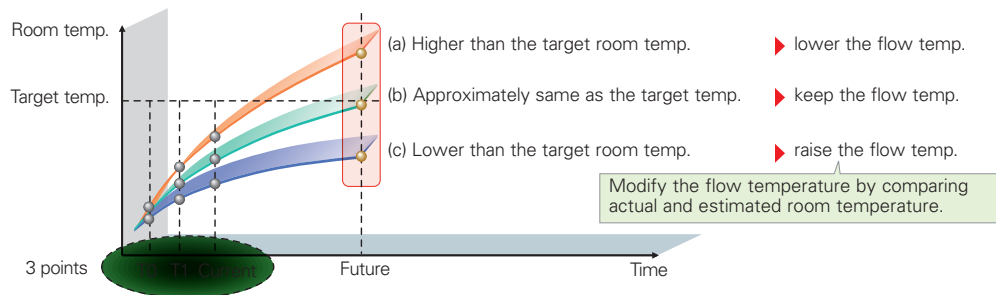

Auto Adaptation – room temperature control

1. Installation site: Southern Sweden
2. Detached house with underfloor heating
3. Data in February 2011



[Example]

a) Outdoor temperature is gradually decreasing...

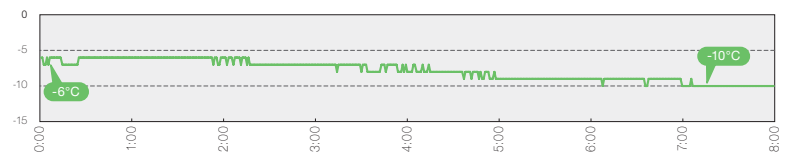

b) Target flow temperature

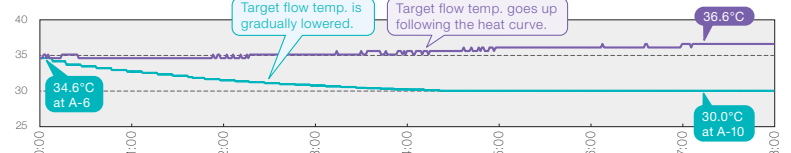

By Auto Adaptation, flow temperature can be lowered even when outdoor temp. is decreasing.

c) Room temperature

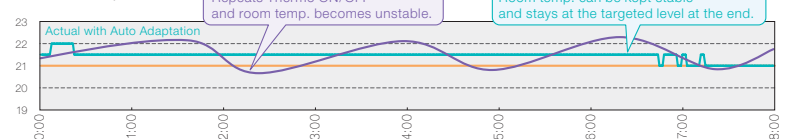

By Auto Adaptation, flow temperature can be lowered without sacrificing comfort.





*SD logo is a trademark of SD-3C, LLC

2 zone control (for heating/cooling)

Simultaneously control two different zones

Using ecodan, it is possible to control two different flow temperatures, thereby managing two different heating load requirements. The system can adjust and maintain two flow temperatures when different temperatures are required for different rooms; for example, controlling a flow temperature of 40°C for the bedroom radiators and another flow temperature of 30°C for the living room floor heating. Another feature of this model is that 2 zone cooling control is now possible. Using these functions it is easy to maintain the most comfortable temperature in each room and to save energy too.

■ Two temperature zones

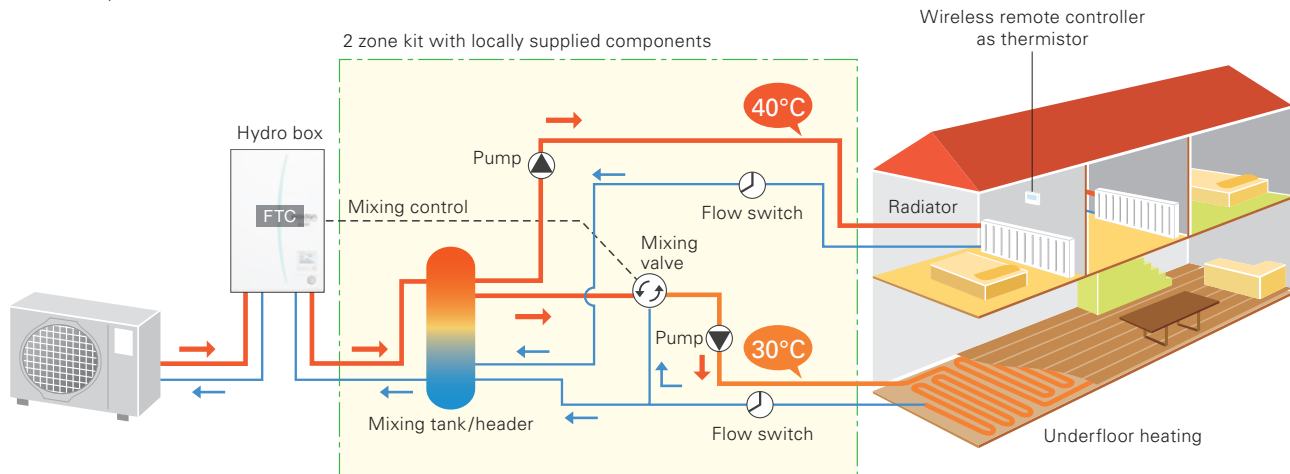

*Items such as a mixing tank, mixing valve flow switch and pumps are not included and need to be purchased locally.

2 zone kit

With optional parts

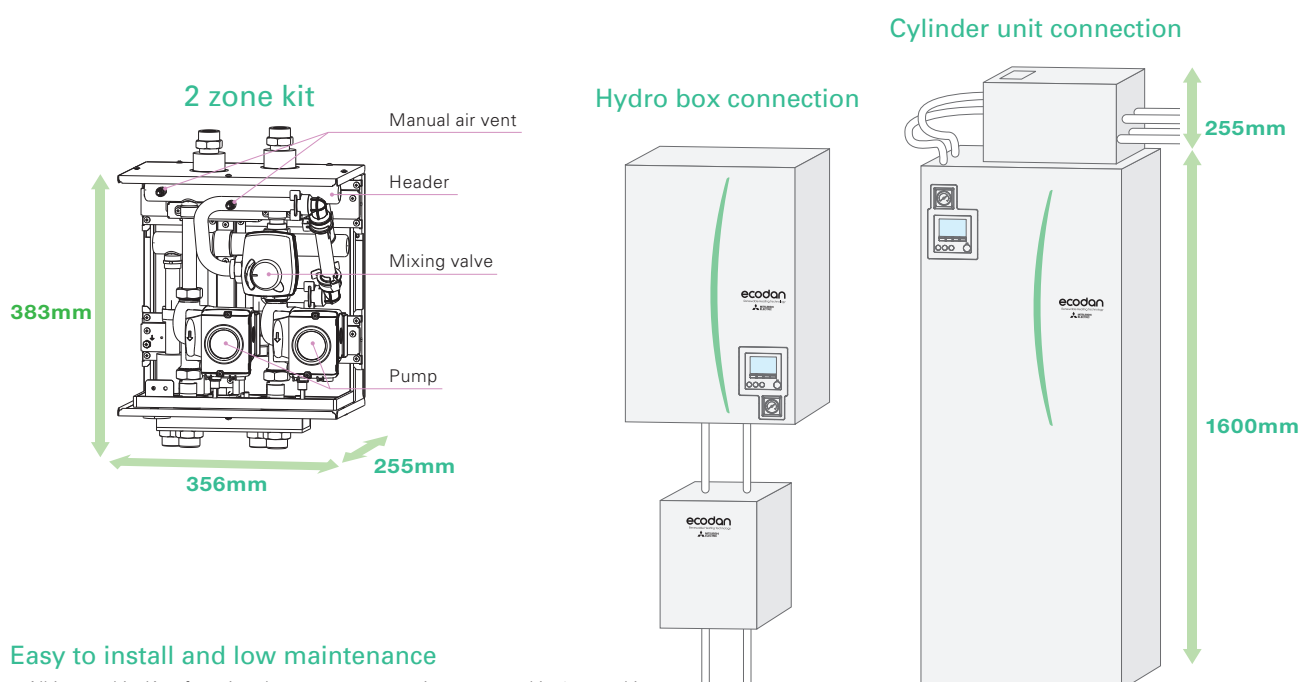

Easy to install and low maintenance

- All-in-one kit: Key functional components are incorporated in 2 zone kit.
- Easy installation: G1 screw type flexi-piping to avoid brazing.
- Compact size: Just to fit on the top of cylinder unit, also wall mountable.



*SD logo is a trademark of SD-3C, LLC

Intelligent hybrid control (boiler interlock)

An existing boiler can be used for extra heating capacity in an efficient way

The flexibility of ecodan's intelligent control allows the system to be combined with the boiler currently in use. Additionally, this control can judge which heating source to use either ecodan or the existing boiler, based on various conditions*.

In the event of one heating unit not working due to some unforeseen problem, the other heating system can be used as a back-up, thereby preventing the heating system operation from stopping completely.

*Please see below "Heat source switchover".

Intelligent system combining a boiler with ecodan

■ Intelligent boiler interlock system

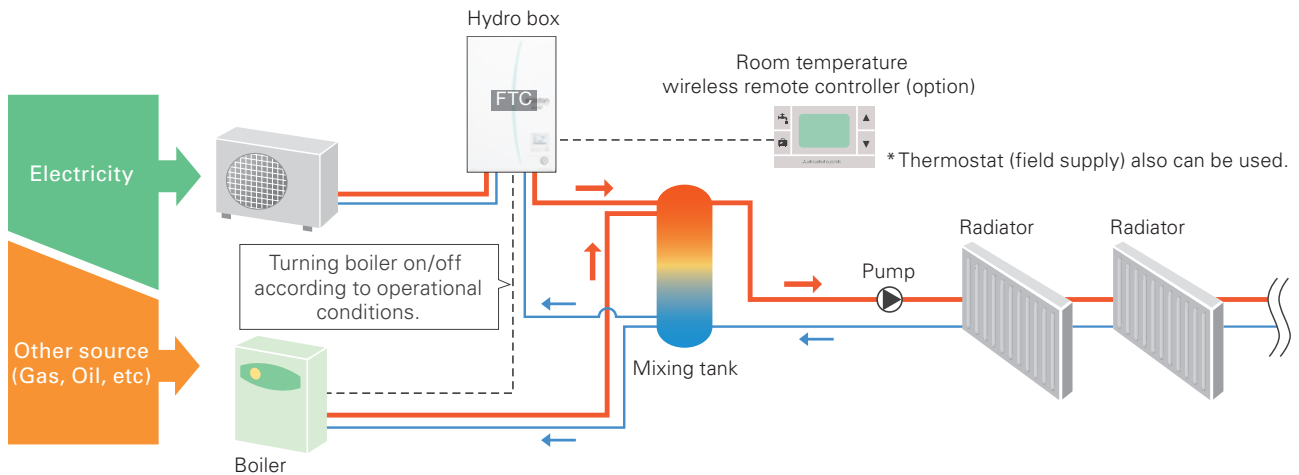

* Items such as a mixing tank, and pump are not included and need to be purchased locally.

Heat source switchover - Choose appropriate system based on needs

4 types of heat source switchover logic

- ① Switchover based on actual outdoor temperature
 - Heat source switchover occurs when the outdoor temperature drops below a pre-set temperature.
- ② Switchover based on running cost
 - Heat source switchover occurs by judging optimal operation based on running cost.
 - *Pre-registration of the energy price of electricity, and gas or oil per 1kWh is necessary.
- ③ Switchover based on CO₂ emission level
 - Heat source switchover occurs to minimise CO₂ emission.
 - *Pre-registration of CO₂ emission amount from electricity and gas or oil is necessary.
- ④ Switchover can also be activated via external input
 - For example, the peak cut signal from electric power company.

Smart Grid Ready function

In recent years renewable energy generation has become popular. However, this rapid growing causes the problem of supply and demand gap of electricity. The aim of "SG Ready" is to make the electricity demand response more flexible by creating a uniform interface for the smart grid integration of heat pumps. Air-to-Water units need to be able to change the operation pattern when the signal is received from the Smart Grid Controller.

New ecodan Cylinder, Hydro box and FTC have been modified to communicate with Smart Grid Controller. The communication protocol is based on "SG Ready" label regulation. (Version 1.1; gültig ab 01.01.2013)

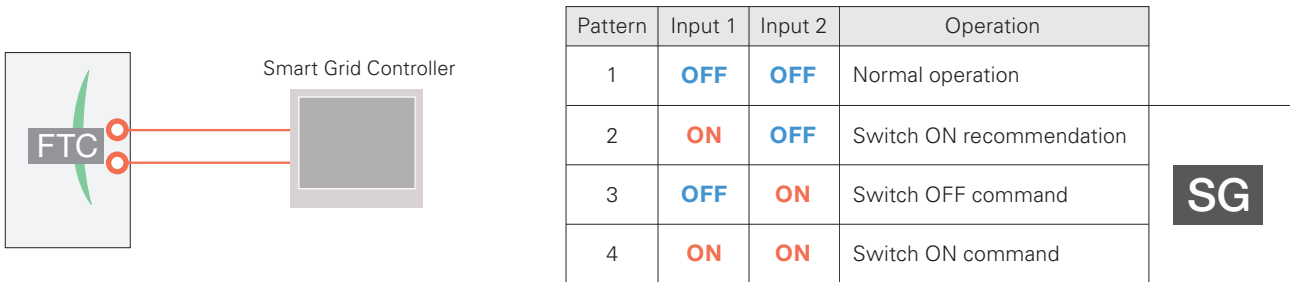

Pattern 1: Normal operation

When there is no signal from the Smart Grid Controller, DHW and Heating operate according to user settings.

Pattern 2: Switch ON recommendation

When set to the "Switch ON" recommendation, the target temperature of DHW is increased a specified amount and the heating "Thermo ON" condition range is extended.

Pattern 3: Switch OFF command

When the "Switch OFF" command is received, both DHW and Heating are turned off.

Pattern 4: Switch ON command

When the "Switch ON" command is received, the target temperature of DHW is increased to the maximum target temperature and Heating continues.

Multiple unit control

Connect up to 6 units – Automatic control of multiple units for bigger capacity and better efficiency

A maximum of 6 units* can be configured according to the heating/cooling load of the building. The most efficient number of operating units is determined automatically based on heating/cooling load. This enables ecodan to provide optimal room temperature control, and thus superior comfort for room occupants. Also incorporated is a rotation function that enables each unit to run for an equal time period.

If one of the units malfunctions when using the Multiple Unit Control, another unit can be automatically operated for back-up, thereby preventing the system operation from stopping completely.

*Only same models (same capacity) can be used.

Multiple unit control

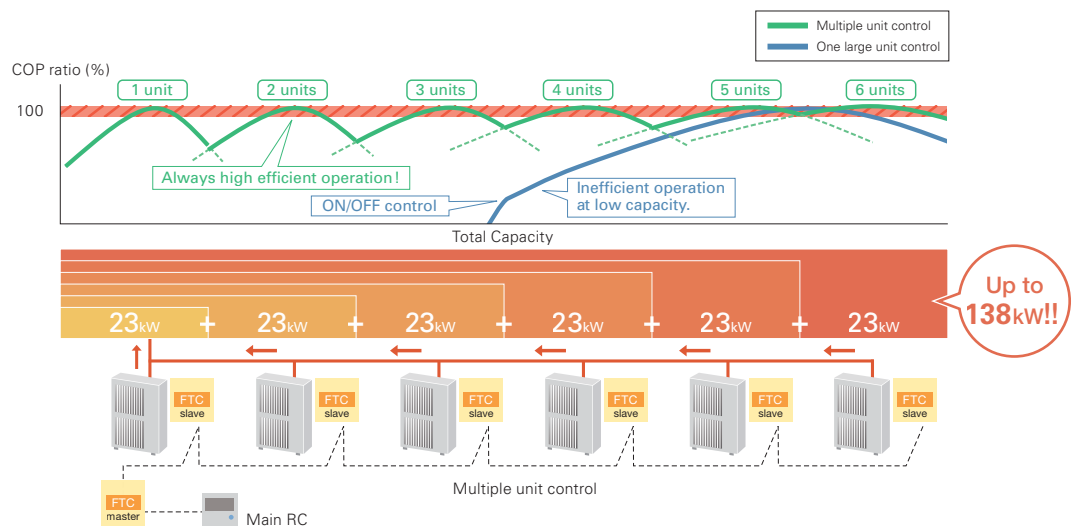

Remote controllers

Smart user-friendly controller with stylish design

Main remote controller

- Large screen and backlight for excellent visibility, even in dark environment
- Multi-language support (supports 15 languages)
- Can be removed from main unit and installed in a remote location (up to 500m)
- Quick reading of operation data (7.5 times faster than previous model)
- Wide range of convenient functions in response to user demand

Function settings

- Energy monitoring
- Two-zone control (cooling and heating)
- Two separate schedules
- Summer time setting
- Built-in room temperature sensors
- Hybrid control (boiler interlock)
- Floor drying mode
- Weekly timer
- Holiday mode
- Legionella prevention
- Error codes

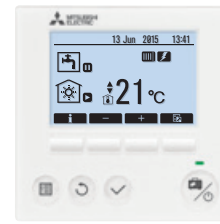

Main controller



PAR-WR51R-E (Option) Receiver



PAR-WT50R-E (Option) Wireless remote controller

Wireless remote controller (optional)

- Built-in room temperature sensor; easy to place in the best position to detect room temperature
- Wiring work eliminated
- Simple design that is easy to operate
- Remote control from any room without needing to choose an installation location
- Backlight and big buttons that are easy to operate
- Domestic hot water boost and cancellation
- Simplified holiday mode



*SD logo is a trademark of SD-3C, LLC

Energy monitoring

View electricity consumption and heat output on the remote controller

Every end user can now easily check the energy data of the ecodan heat pump.

Other features

- Daily, monthly and yearly data are stored and can be displayed using the main remote controller.
- External power meter and heat meter can be connected for accurate measurement.
- SD card is also available for storing data.

*Using pre-set values on the main remote controller, estimated energy consumption/output can be shown without external power and a heat meter.

Depending on operating condition and system configuration, there is some possibility to show different data from the reality.

*This function is available depending on the version of the outdoor unit model.

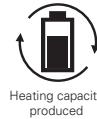

Heating capacity produced



Electric energy used

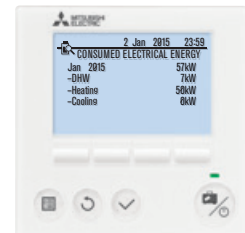

*SD logo is a trademark of SD-3C, LLC

Summer time setting

Easy adjustment for summer time

Just switch the summer time mode 'on' using the main remote controller and the clock in the main remote controller is adjusted to summer time hours.

This function can release the end user from clock setting tasks.

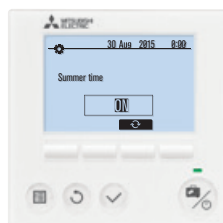
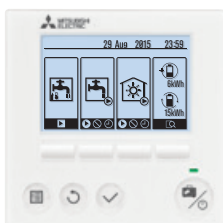

Two separate schedules

Pre-setting two different schedules for winter and summer seasons

Two different schedule settings are available for use via the main remote controller.

These schedules can be pre-set and changed depending on the season. For example, from November to March, space heating and domestic hot water are used; however, during warm months such as from April to October, only domestic hot water is used.

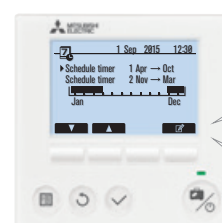

<Example>

Schedule 1	Winter time
Space heating	daytime
Domestic hot water	early morning
Schedule 2	Summer time
Domestic hot water	any time

Easy commissioning

Pump for primary water circuit* speed setting possible using ecodan's main remote controller

Even when the system is running, pump output can be set to one of five different settings using the main remote controller.

The person commissioning the system can adjust this speed much more easily.

*Speed setting of pump for domestic hot water is not available through the main remote controller when the system is running.

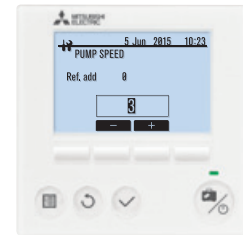

Flow sensor newly incorporated

The flow sensor is key for monitoring energy output and can also be used to detect flow error as well.

– Flow rate can be checked on the main remote controller.

– Flow rate can also be shown as graphs using the SD card tool.

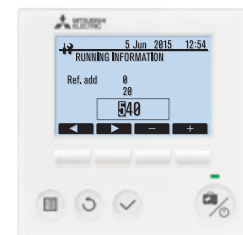

Run indoor unit* without outdoor unit

During installation or situations such as an outdoor unit malfunction, the indoor unit can be operated using a heater.

While using this mode, flow and tank temperature are selectable.

Fixing and maintenance of the outdoor unit can be done without stopping heating and domestic hot water operation*.

*Models with electric heater only.

*When the indoor unit operation stops, please check all settings after the outdoor unit is connected.



*SD logo is a trademark of SD-3C, LLC

SD* card

For easier settings and data logging

The initial setting for ecodan is now simpler than ever before. The special software enables the required initial settings to be saved to an SD card using a personal computer. The system set-up is as easy as moving the SD card from the computer to the SD card slot in the indoor unit. Compared to the previous procedure of inputting settings using the main controller at the installation site, a remarkable reduction in set-up time has been achieved. Thus, it is ideal for busy installers.

*SD card function is only used at the time of installation.

Hydro box operation panel

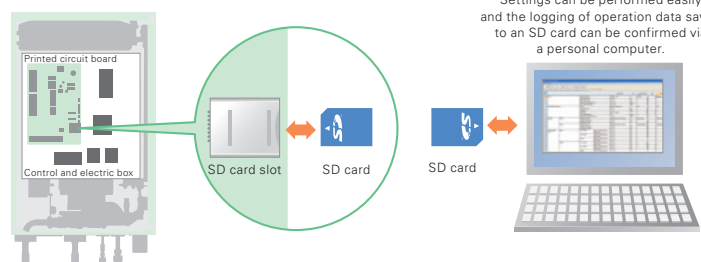

Items that can be pre-set

Simply copying pre-set data to an SD card, the same settings can input into another unit using the SD card.

- Initial settings (time display, contact number, etc.)
- Heating settings
 - Auto adaptation
 - Heat curve
 - Two different temperature zones (heating and cooling)
- Interlocked boiler operation settings
- Holiday mode settings
- Schedule timer settings (two separate schedules)
- Domestic hot water settings
- Legionella prevention settings

All items that are set by the main controller can be set via a personal computer.

Data that can be stored

Operation data up to a month long can be stored on a single SD card

- Consumed electrical energy
- Delivered energy
- Flow rate
- Operation time
- Defrost time
- Actual temperature
 - Room temperature
 - Flow temperature
 - Return temperature
 - Domestic hot water temperature
 - Outdoor temperature
- Error record
- Input signal
- Etc.

Split type specifications

Indoor unit

<Cylinder unit>

Model name			Small capacity					Medium capacity								UK model		
			EHST20D-VM2C	EHST20D-YM9C	EHST20D-VM2EC	EHST20D-MHC	EHST20D-MEC	EHST20C-VM2C	EHST20C-VM6C	EHST20C-YM9C	EHST20C-TM9C	EHST20C-VM2EC	EHST20C-VM6EC	EHST20C-YM9EC	EHST20C-MEC	EHST20C-MHCW	EHST20D-MHCW	
Type			Heating only															
Immersion heater			-	-	-	x	-	-	-	-	-	-	-	-	-	-	x	x
Expansion vessel			x	x	-	x	-	x	x	x	x	-	-	-	-	x	x	
Booster heater			x	x	x	-	-	x	x	x	x	x	x	-	-	-	-	
Dimensions			HxWxD	mm														
Weight (empty)			kg	103	105	97	103	96	110	111	112	112	104	105	106	103	110	103
Power supply (V/Phase/Hz)			230/Single/50															
Heater	Booster heater	Power supply (V/Phase/Hz)	230/Single/50	400/Three/50	230/Single/50	-	-	230/Single/50	400/Three/50	230/Three/50	230/Single/50	400/Three/50	-	-	-	-	-	
		Capacity	kW	2	9 (3/6/9)	2	-	-	2	6 (2/4/6)	9 (3/6/9)	9 (3/6/9)	2	6 (2/4/6)	9 (3/6/9)	-	-	
		Current	A	9	13	9	-	-	9	26	13	23	9	26	13	-	-	
		Breaker size	A	16	16	16	-	-	16	32	16	32	16	32	16	-	-	
	Immersion heater	Power supply (V/Phase/Hz)	-			230/Single/50	-	-	-	-	-	-	-	-	-	-	230/Single/50	
		Capacity	kW	-			3	-	-	-	-	-	-	-	-	-	3	
		Current	A	-			13	-	-	-	-	-	-	-	-	-	13	
		Breaker size	A	-			16	-	-	-	-	-	-	-	-	-	16	
Domestic hot water tank	Volume / Material	L / -	200 / Stainless steel															
Guaranteed operating range*1	Ambient	°C	0-35*1															
	Outdoor	Heating	°C	See outdoor unit spec table														
		Cooling	°C	-														
Target temperature range	Heating	Room temperature	°C											10-30				
		Flow temperature	°C											25-60				
	Cooling	Room temperature	°C											-				
		Flow temperature	°C											-				
	DHW	°C	°C											40-60				
	Legionella prevention	°C	°C											60-70				
Sound pressure level (SPL)		dB (A)	28															

*1 The indoor environment must be frost-free

<Hydro box>

Model name			Small capacity				Medium capacity								Large capacity			
			EHSD-MEC	EHSD-MC	EHSD-VM2C	EHSD-YM9C	EHSC-MEC	EHSC-VM2C	EHSC-VM2EC	EHSC-VM6C	EHSC-VM6EC	EHSC-YM9C	EHSC-YM9EC	EHSC-TM9C	EHSE-MEC	EHSE-YM9EC		
Type			Heating only															
Immersion heater			-	-	-	-	-	-	-	-	-	-	-	-	-	-	-	-
Expansion vessel			-	x	x	x	-	x	-	x	-	x	-	x	-	x	-	-
Booster heater			-	-	x	x	-	x	x	x	x	x	x	x	-	x	-	x
Dimensions			HxWxD	mm											950x600x360			
Weight (empty)			kg	38	43	44	45	42	48	43	49	44	49	44	49	60	62	
Power supply (V/Phase/Hz)			230/Single/50															
Heater	Booster heater	Power supply (V/Phase/Hz)	-	-	230/Single/50	400/Three/50	-	-	230/Single/50	400/Three/50	230/Three/50	230/Single/50	400/Three/50	230/Three/50	-	-	400/Three/50	
		Capacity	kW	-	-	2	9 (3/6/9)	-	-	2	2	6 (2/4/6)	6 (2/4/6)	9 (3/6/9)	9 (3/6/9)	9 (3/6/9)	-	9 (3/6/9)
		Current	A	-	-	9	13	-	-	9	9	26	26	13	13	23	-	13
		Breaker size	A	-	-	16	16	-	-	16	16	32	32	16	16	32	-	16
Guaranteed operating range*1	Ambient	°C	0-35*1															
	Outdoor	Heating	°C	See outdoor unit spec table														
		Cooling	°C	-														
Target temperature range	Heating	Room temperature	°C											10-30				
		Flow temperature	°C											25-60				
	Cooling	Room temperature	°C											-				
		Flow temperature	°C											-				
Sound pressure level (SPL)		dB (A)	28											30				

*1 The indoor environment must be frost-free

<Reversible cylinder unit>

Model name			Small capacity		Medium capacity		
			ERST20D-VM2C	ERST20D-MEC	ERST20C-VM2C	ERST20C-MEC	
Type			Heating and cooling				
Immersion heater			-	-	-	-	
Expansion vessel			x	-	x	-	
Booster heater			x	-	x	-	
Dimensions			HxWxD	mm			
Weight (empty)			kg	103	96	110	103
Power supply (V/Phase/Hz)			230/Single/50				
Heater	Booster heater	Power supply (V/Phase/Hz)	230/Single/50	-	230/Single/50	-	
		Capacity	kW	2	-	2	-
		Current	A	9	-	9	-
		Breaker size	A	16	-	16	-
	Immersion heater	Power supply (V/Phase/Hz)	-	-	-	-	
		Capacity	kW	-	-	-	-
		Current	A	-	-	-	-
		Breaker size	A	-	-	-	-
Domestic hot water tank	Volume / Material	L / -	200 / Stainless steel				
Guaranteed operating range*1	Ambient	°C	0-35*1				
	Outdoor	Heating	°C	See outdoor unit spec table			
		Cooling	°C	See outdoor unit spec table (minimum 10°C*2)			
Target temperature range	Heating	Room temperature	°C			10-30	
		Flow temperature	°C			25-60	
	Cooling	Room temperature	°C			-	
		Flow temperature	°C			5-25	
	DHW	°C	°C			40-60	
	Legionella prevention	°C	°C			60-70	
Sound pressure level (SPL)		dB (A)	28				

*1 The indoor environment must be frost-free

*2 If you use our system in cooling mode at the low ambient temperature (10°C or below), there are some risks of plate heat exchanger breaking by frozen water.

<Reversible hydro box>

Model name			Small capacity		Medium capacity		Large capacity	
			ERSD-VM2C	ERSD-MEC	ERSD-VM2C	ERSE-MEC	ERSE-VM9EC	
Type			Heating and cooling					
Immersion heater			-	-	-	-	-	
Expansion vessel			x	-	x	-	-	
Booster heater			x	-	x	-	x	
Dimensions			HxWxD	mm		800x530x360		950x600x360
Weight (empty)			kg	45	43	49	61	63
Power supply (V/Phase/Hz)			230/Single/50					
Heater	Booster heater	Power supply (V/Phase/Hz)	230/Single/50	-	230/Single/50	-	400/Three/50	
		Capacity	kW	2	-	2	-	9 (3/6/9)
		Current	A	9	-	9	-	13
		Breaker size	A	16	-	16	-	16
Guaranteed operating range*1	Ambient	°C	0-35*1					
	Outdoor	Heating	°C	See outdoor unit spec table				
		Cooling	°C	See outdoor unit spec table (minimum 10°C*2)				
Target temperature range	Heating	Room temperature	°C			10-30		
		Flow temperature	°C			25-60		
	Cooling	Room temperature	°C			-		
		Flow temperature	°C			-		
Sound pressure level (SPL)		dB (A)	28		30			

*1 The environment must be frost-free

*2 If you use our system in cooling mode at the low ambient temperature (10°C or below), there are some risks of plate heat exchanger breaking by frozen water.

Outdoor unit

Model name			Eco Inverter		Power Inverter						
			SUHZ-SW45VA (H)*1	PUHZ-SW50VKA (-BS)	PUHZ-SW75V/YAA (-BS)	PUHZ-SW100V/YAA (-BS)	PUHZ-SW75VHA (-BS)	PUHZ-SW100V/YHA (-BS)	PUHZ-SW120V/YHA (-BS)	PUHZ-SW160YKA (-BS)	PUHZ-SW200YKA (-BS)
Dimensions	HxWxD	mm	880x840x330	630x809x300	1020x1050x480	1020x1050x480	943x950x330	1350x950x330	1350x950x330	1338x1050x330	1338x1050x330
Weight		kg	54	43	92/104	114/126	75	118/130	118/130	136	136
Power supply (V / Phase / Hz)			VA(H), VAA, VHA : 230/Single/50 YHA, YKA, YAA : 400/Three/50								
Heating (A7/W35)	Capacity	kW	4.50	5.50	8.00	11.20	8.00	11.20	16.00	22.00	25.00
	COP		5.06	4.42	4.40	4.46	4.40	4.45	4.10	4.20	4.00
	Power input	kW	0.889	1.244	1.818	2.511	1.818	2.517	3.902	5.238	6.250
Heating (A2/W35)	Capacity	kW	3.50	5.00	7.50	10.00	7.50	10.00	12.00	16.00	20.00
	COP		3.40/3.04	2.97	3.40	3.32	3.40	3.32	3.24	3.11	2.80
	Power input	kW	1.029/1.151	1.684	2.206	3.009	2.206	3.009	3.704	5.145	7.143
Cooling (A35/W7)	Capacity	kW	4.00	4.50	7.10	10.00	6.60	9.10	12.50	16.00	20.00
	EER		2.73	2.76	2.70	2.83	2.82	2.75	2.32	2.76	2.25
	Power input	kW	1.465	1.630	2.630	3.534	2.340	3.309	5.388	5.797	8.889
Cooling (A35/W18)	Capacity	kW	3.80	5.00	7.10	10.00	7.10	10.00	14.00	18.00	22.00
	EER		4.28	4.60	4.43	4.47	4.43	4.35	4.08	4.56	4.10
	Power input	kW	0.888	1.087	1.603	2.237	1.603	2.299	3.431	3.947	5.366
Sound pressure level (SPL)	Heating	dB (A)	52	46	43	47	51	54	54	62	62
Sound power level (PWL)	Heating	dB (A)	61	63	58	60	68	70	72	78	78
Operating current (max)		A	12.0	13.0	22.0/11.5	28.0/12.0	17.0	29.5/13.0	29.5/13.0	19.0	21.0
Breaker size		A	20	16	25/16	32/16	25	32/16	32/16	25	32
Piping	Diameter	Liquid/Gas	mm	6.35/12.7	6.35/12.7	9.52/15.88	9.52/15.88	9.52/15.88	9.52/15.88	9.52/15.88	12.7/25.4
	Max. length	Out-In	m	30	40	40	75	40	75	80	80
	Max. height	Out-In	m	30	30	10	10	30	30	30	30
Guaranteed operating range	Heating	°C	-15 to +24	-15 to +21	-20 to +21	-20 to +21	-20 to +21	-20 to +21	-20 to +21	-20 to +21	-20 to +21
	DHW	°C	-15 to +35	-15 to +35	-20 to +35	-20 to +35	-20 to +35	-20 to +35	-20 to +35	-20 to +35	-20 to +35
	Cooling*2	°C	+10 to +46	-15 to +46	-15 to +46	-15 to +46	-15 to +46	-15 to +46	-15 to +46	-15 to +46	-15 to +46

Model name			ZUBADAN						
			PUHZ-SHW80V/YAA (-BS)	PUHZ-SHW112V/YAA (-BS)	PUHZ-SHW80VHA	PUHZ-SHW112V/YHA	PUHZ-SHW140YHA	PUHZ-SHW230YKA2	
Dimensions	HxWxD	mm	1020x1050x480	1020x1050x480	1350x950x330	1350x950x330	1350x950x330	1338x1050x330	
Weight		kg	116/128	116/128	120	120/134	134	143	
Power supply (V / Phase / Hz)			VAA, VHA : 230/Single/50 YHA, YKA, YAA : 400/Three/50						
Heating (A7/W35)	Capacity	kW	8.00	11.20	8.00	11.20	14.00	23.00	
	COP		4.65	4.40	4.65	4.46	4.22	3.65	
	Power input	kW	1.720	2.545	1.720	2.511	3.318	6.301	
Heating (A2/W35)	Capacity	kW	8.00	11.20	8.00	11.20	14.00	23.00	
	COP		3.55	3.22	3.55	3.34	2.96	2.37	
	Power input	kW	2.254	3.478	2.254	3.353	4.730	9.705	
Cooling (A35/W7)	Capacity	kW	7.10	10.00	7.10	10.00	12.50	20.00	
	EER		3.31	2.83	3.31	2.83	2.17	2.22	
	Power input	kW	2.145	3.534	2.145	3.534	5.760	9.009	
Cooling (A35/W18)	Capacity	kW	7.10	10.00	7.10	10.00	12.50	20.00	
	EER		4.52	4.74	4.52	4.74	4.26	3.55	
	Power input	kW	1.571	2.110	1.571	2.110	2.934	5.634	
Sound pressure level (SPL)	Heating	dB (A)	45	47	51	52	52	59	
Sound power level (PWL)	Heating	dB (A)	59	60	69	70	70	75	
Operating current (max)		A	22.0/13.0	28.0/13.0	29.5	35.0/13.0	13.0	20.0	
Breaker size		A	25/16	32/16	32	40/16	16	25	
Piping	Diameter	Liquid/Gas	mm	9.52/15.88	9.52/15.88	9.52/15.88	9.52/15.88	9.52/15.88	12.7/25.4
	Max. length	Out-In	m	75	75	75	75	75	80
	Max. height	Out-In	m	30	30	30	30	30	30
Guaranteed operating range	Heating	°C	-28 to +21	-28 to +21	-28 to +21	-28 to +21	-28 to +21	-25 to +21	
	DHW	°C	-28 to +35	-28 to +35	-28 to +35	-28 to +35	-28 to +35	-25 to +35	
	Cooling*2	°C	-15 to +46	-15 to +46	-15 to +46	-15 to +46	-15 to +46	-15 to +46	

Note: based on EN 14511 (Input to circulation pump is not included.) It may differ according to the system configuration.

*1 SUHZ-SW45VAH incorporates base heater.

*2 Optional air protection guide is required where ambient temperature is lower than -5°C.

Split type	Small capacity (Under 5kW)	Medium capacity (7.5kW-14kW)	Large capacity (≥ 16kW)
		 PUHZ-SHW80/112AA	 PUHZ-SHW80/112/140
	 PUHZ-SW50	 PUHZ-SW75	 PUHZ-SW160/200
Eco Inverter	 SUHZ-SW45	 PUHZ-SW75/100AA	 PUHZ-SW100/120

Packaged type specifications

Indoor unit

<Cylinder unit>



Model name		EHPT20X-VM2C		EHPT20X-VM6C		EHPT20X-YM9C		EHPT20X-TM9C		EHPT20X-MHCW*2					
Type		Heating only													
		Immersion heater		-		-		-		-		x			
		Expansion vessel		x		x		x		x		x			
		Booster heater		x		x		x		x		-			
Dimensions		HxWxD		mm		1600x595x680									
Weight (empty)		kg		98		99		100		100		98			
Power supply (V/Phase/Hz)		230/Single/50						230/Single/50							
Heater		Booster heater		Power supply (V/Phase/Hz)		230/Single/50		400/Three/50		230/Three/50		-			
				Capacity		kW		2		6 (2/4/6)		9 (3/6/9)		-	
				Current		A		9		26		13		23	
				Breaker size		A		16		32		16		32	
		Immersion heater		Power supply (V/Phase/Hz)		-		-		-		-		230/Single/50	
				Capacity		kW		-		-		-		3	
				Current		A		-		-		-		13	
				Breaker size		A		-		-		-		16	
Domestic hot water tank		Volume / Material		L / -		200 / Stainless steel									
Guaranteed operating range*1		Ambient		°C		0-35*1									
		Outdoor		°C		See outdoor spec table									
Target temperature range		Heating		Room temperature		°C						10-30			
				Flow temperature		°C						25-60			
		DHW		°C		40-60									
		Legionella prevention		°C		60-70									
Sound pressure level (SPL)		dB (A)		28											

*1 The indoor environment must be frost-free *2 UK model

<Hydro box>

Model name		EHPX-VM2C		EHPX-VM6C		EHPX-YM9C							
Type		Heating only											
		Immersion heater		-		-		-					
		Expansion vessel		x		x		x					
		Booster heater		x		x		x					
Dimensions		HxWxD		mm		800x530x360							
Weight (empty)		kg		37		38		38					
Power supply (V/Phase/Hz)		230/Single/50											
Heater		Booster heater		Power supply (V/Phase/Hz)		230/Single/50		230/Single/50		400/Three/50			
				Capacity		kW		2		6 (2/4/6)		9 (3/6/9)	
				Current		A		9		26		13	
				Breaker size		A		16		32		16	
Guaranteed operating range*1		Ambient		°C		0-35*1							
		Outdoor		°C		See outdoor spec table							
Target temperature range		Heating		Room temperature		°C				10-30			
				Flow temperature		°C				25-60			
Sound pressure level (SPL)		dB (A)		28									

*1 The indoor environment must be frost-free

Outdoor unit

Model name			Power Inverter						ZUBADAN				
			PUHZ-W50VHA2(-BS)	PUHZ-W60VAA(-BS)	PUHZ-W85V/YAA(-BS)	PUHZ-W112V/YAA(-BS)	PUHZ-W85VHA2(-BS)	PUHZ-W112VHA(-BS)	PUHZ-HW112VHA2(-BS)	PUHZ-HW140V/YHA2(-BS)			
Dimensions			HxWxD	mm	740x950x330	1020x1050x480	1020x1050x480	1020x1050x480	943x950x330	1350x1020x330	1350x1020x330	1350x1020x330	
Weight			kg	64	97	97/110	118/131	79	133	148	134/148		
Power supply (V/Phase/Hz)			VAA, VHA : 230/Single/50, YAA, YHA : 400/Three/50										
Heating (A7/W35)			Capacity	kW	5.00	6.00	9.00	11.20	9.00	11.20	11.20	14.00	
			COP		4.50	4.83	4.51	4.54	4.18	4.47	4.42	4.25	
			Power input	kW	1.111	1.242	1.996	2.467	2.153	2.506	2.534	3.294	
Heating (A2/W35)			Capacity	kW	5.00	6.00	8.50	11.20	8.50	11.20	11.20	14.00	
			COP		3.50	3.64	3.36	3.34	3.17	3.34	3.11	3.11	
			Power input	kW	1.429	1.648	2.530	3.353	2.681	3.353	3.601	4.502	
Sound pressure level (SPL)			Heating	dB (A)	46	45	45	47	48	53	53	53	
Sound power level (PWL)			Heating	dB (A)	61	58	58	60	66	69	67	67	
Operating current (max)			A	13.0	13.0	22.0/11.5	28.0/13.0	23.0	29.5	13.0	35.0/13.0		
Breaker size			A	16	16	25/16	32/16	25	32	16	40/16		
Guaranteed operating range			Heating	°C	-15 to +21	-20 to +21	-20 to +21	-20 to +21	-20 to +21	-20 to +21	-25 to +21	-25 to +21	
			DHW	°C	-15 to +35	-20 to +35	-20 to +35	-20 to +35	-20 to +35	-20 to +35	-20 to +35	-25 to +35	-25 to +35
			Cooling*1	°C	-15 to +46	-15 to +46	-15 to +46	-15 to +46	-15 to +46	-15 to +46	-15 to +46	-15 to +46	-15 to +46

Note: based on EN 14511 (Input to circulation pump is included.) It may differ according to the system configuration.

*1 Optional air protection guide is required where ambient temperature is lower than -5°C.

Packaged type	Medium capacity (11.2kW-14kW)	Packaged type	Small capacity (Under 5kW)	Medium capacity (6.0kW-11.2kW)
	PUHZ-HW112/140		PUHZ-W50	PUHZ-W60/85/112
				PUHZ-W85
				PUHZ-W112

Optional Parts

Split type

<Indoor unit>

Parts name	Model name	Specification	Cylinder unit																Hydro box					
			EHST20C-VM2C	EHST20C-VM6C	EHST20C-VM9C	EHST20C-TM5C	EHST20C-VM2EC	EHST20C-VM6EC	EHST20C-VM9EC	EHST20C-MEC	EHST20C-VM2C	EHST20C-VM9C	EHST20C-VM2EC	EHST20C-MEC	EHST20C-MHC	EHST20C-MHCW	EHST20C-MHCW	ERST models	E8SD or E8SC models	E8SE models				
Wireless remote controller	PAR-WT50R-E		x	x	x	x	x	x	x	x	x	x	x	x	x	x	x	x	x	x	x	x	x	x
Wireless receiver	PAR-WR51R-E		x	x	x	x	x	x	x	x	x	x	x	x	x	x	x	x	x	x	x	x	x	x
Thermistors	PAC-SE41TS-E	For room temp.	x	x	x	x	x	x	x	x	x	x	x	x	x	x	x	x	x	x	x	x	x	x
	PAC-TH011-E	For buffer and zone (flow and return temp.)	x	x	x	x	x	x	x	x	x	x	x	x	x	x	x	x	x	x	x	x	x	x
	PAC-TH011TK-E	For tank temp. (5m)	-	-	-	-	-	-	-	-	-	-	-	-	-	-	-	-	-	-	-	-	-	-
	PAC-TH011TKL-E	For tank temp. (30m)	-	-	-	-	-	-	-	-	-	-	-	-	-	-	-	-	-	-	-	-	-	-
	PAC-TH011HT-E	For boiler (flow and return temp.)	x	x	x	x	x	x	x	x	x	x	x	x	x	x	x	x	x	x	x	x	x	x
Immersion heater	PAC-IH03V2-E	1Ph 3kW	x	x	x	x	x	x	x	x	x	x	x	x	x	-	-	-	-	-	x	-	-	
EHPT accessories for UK	PAC-WK01UK-E		-	-	-	-	-	-	-	-	-	-	-	-	-	-	-	x	x	-	-	-	-	
Joint pipe	PAC-SG73RJ-E	For PUHZ-SW200YKA/SHW230YKA2 (-BS) ø9.52→ø12.7	-	-	-	-	-	-	-	-	-	-	-	-	-	-	-	-	-	-	-	-	-	x
Wi-Fi interface	MAC-567IF-E		x	x	x	x	x	x	x	x	x	x	x	x	x	x	x	x	x	x	x	x	x	x
Drain pan stand	PAC-DP01-E	D665mm H270mm W595mm NW: 14.5kg	-	-	-	-	-	-	-	-	-	-	-	-	-	-	-	-	-	-	-	-	x*1	-
2 zone kit	PAC-TZ01-E		x	x	x	x	x	x	x	x	x	x	x	x	x	x	x	x	x	x	x	x	x	-

*1 PAC-DP01-E is necessary when you use ERST units. If you use ERST units without this parts, drain will be flowed from the base of units, in cooling mode.

<Outdoor unit>

Parts name	Model name	Eco Inverter	Power Inverter										ZUBADAN										
			SUHZ-SW45VA(H)	PUHZ-SW50VKA(-BS)	PUHZ-SW75VYAA(-BS)	PUHZ-SW100VYAA(-BS)	PUHZ-SW75VHA(-BS)	PUHZ-SW100VYHA(-BS)	PUHZ-SW120VYHA(-BS)	PUHZ-SW160VKA(-BS)	PUHZ-SW200VKA(-BS)	PUHZ-SHW80VYAA(-BS)	PUHZ-SHW112VYAA(-BS)	PUHZ-SHW80VHA	PUHZ-SHW112VYHA	PUHZ-SHW140VYHA	PUHZ-SHW230YKA2						
Connector for drain hose heater signal output	PAC-SE60RA-E	-	-	-	x	x	x	x	x	x	x	x	x	x	x	x	x	x	x	x	x	x	x
	PAC-SE61RA-E	-	x	-	-	-	-	-	-	-	-	-	-	-	-	-	-	-	-	-	-	-	-
Air discharge guide	MAC-886SG-E	x	-	-	-	-	-	-	-	-	-	-	-	-	-	-	-	-	-	-	-	-	-
	PAC-SJ07SG-E	-	x	-	-	-	-	-	-	-	-	-	-	-	-	-	-	-	-	-	-	-	-
	PAC-SG59SG-E	-	-	-	-	-	x	x	x	-	-	-	-	-	-	-	x	x	x	-	-	-	-
Air protection guide	PAC-SH96SG-E	-	-	-	x*1	x*1	-	-	-	-	-	x	x	x*1	x*1	-	-	-	-	-	-	-	x
	PAC-SJ06AG-E	-	x	-	-	-	-	-	-	-	-	-	-	-	-	-	-	-	-	-	-	-	-
	PAC-SH63AG-E	-	-	-	-	-	x	x	x	-	-	-	-	-	-	-	x	x	x	-	-	-	-
Attachment	PAC-SH95AG-E	-	-	-	x*1	x*1	-	-	-	-	-	x	x	x*1	x*1	-	-	-	-	-	-	-	x
	PAC-SJ82AT-E	-	-	-	x	x	-	-	-	-	-	-	-	-	-	-	x	x	-	-	-	-	-
Drain socket	PAC-SG61DS-E	-	-	-	x	x	x	x	x	x	x	x	x	x	x	-	-	-	-	-	-	-	-
	PAC-SJ08DS-E	-	x	-	-	-	-	-	-	-	-	-	-	-	-	-	-	-	-	-	-	-	-
Centralised drain pan	PAC-SG63DP-E	-	x	-	-	-	-	-	-	-	-	-	-	-	-	-	-	-	-	-	-	-	-
	PAC-SG64DP-E	-	-	-	-	-	x	x	x	-	-	-	-	-	-	-	-	-	-	-	-	-	-
	PAC-SH97DP-E	-	-	-	-	-	-	-	-	-	-	x	x	-	-	-	-	-	-	-	-	-	-
	PAC-SJ83DP-E	-	-	-	x	x	-	-	-	-	-	-	-	-	-	-	x	x	-	-	-	-	-
Control/Service tool	PAC-SK52ST	-	x	x	x	x	x	x	x	x	x	x	x	x	x	x	x	x	x	x	x	x	x

*1 Attachment (PAC-SJ82AT-E) is necessary for the Air Guide.

Package type

<Indoor unit>

Parts name	Model name	Specification	Cylinder unit					Hydro box			
			EHPT20X-VM2C	EHPT20X-VM6C	EHPT20X-VM9C	EHPT20X-TM9C	EHPT20X-MHCW	EHPX-VM2C	EHPX-VM6C	EHPX-VM9C	
Wireless remote controller	PAR-WT50R-E		x	x	x	x	x	x	x	x	x
Wireless receiver	PAR-WR51R-E		x	x	x	x	x	x	x	x	x
Thermistors	PAC-SE41TS-E	For room temp.	x	x	x	x	x	x	x	x	x
	PAC-TH011-E	For buffer and zone (flow and return temp.)	x	x	x	x	x	x	x	x	x
	PAC-TH011TK-E	For tank temp.	-	-	-	-	-	-	-	-	-
	PAC-TH011TKL-E	For tank temp. (longer)	-	-	-	-	-	-	-	-	-
	PAC-TH011HT-E	For boiler (flow and return temp.)	x	x	x	x	x	x	x	x	x
Immersion heater	PAC-IH03V2-E	1Ph 3kW	x	x	x	x	x	-	-	-	-
EHPT accessories for UK	PAC-WK01UK-E		-	-	-	-	-	-	-	-	-
Wi-Fi interface	MAC-567IF-E		x	x	x	x	x	x	x	x	x
2 zone kit	PAC-TZ01-E		x	x	x	x	x	x	x	x	x

<Outdoor unit>

Parts name	Model name	Power Inverter							ZUBADAN			
		PUHZ-W50VHA2(-BS)	PUHZ-W60VAA(-BS)	PUHZ-W85VYAA(-BS)	PUHZ-W112VYAA(-BS)	PUHZ-W85VHA2(-BS)	PUHZ-W112VHA(-BS)	PUHZ-HW112VHA2(-BS)	PUHZ-HW140VHA2(-BS)	PUHZ-HW140VYAA2(-BS)		
Connector for drain hose heater signal output	PAC-SE60RA-E	x	x	x	x	x	x	x	x	x	x	
	PAC-SG59SG-E	x	-	-	-	x	x	x	x	x	x	
Air discharge guide	PAC-SH96SG-E	-	x*	x*	x*	x*	-	-	-	-	-	
	PAC-SH63AG-E	x	-	-	-	x	x	x	x	x	x	
Air protection guide	PAC-SH95AG-E	-	x*	x*	x*	-	-	-	-	-	-	
Attachment	PAC-SJ82AT-E	-	x	x	x	-	-	-	-	-	-	
Drain socket	PAC-SG61DS-E	x	x	x	x	x	x	-	-	-	-	
Centralised drain pan	PAC-SG64DP-E	x	-	-	-	x	x	-	-	-	-	
	PAC-SJ83DP-E	-	x	x	x	-	-	-	-	-	-	
Control/Service tool	PAC-SK52ST	-	-	-	-	-	-	-	-	-	-	

*Attachment(PAC-SJ82AT-E) is necessary for the Air Guide.

Interface/Flow temperature controller

Parts name	Model name	Description
Capacity step control interface	PAC-IF011B-E	1 PC Board w/ Case
Flow temperature controllers	PAC-IF032B-E	1 PC Board w/ Case
System controllers	PAC-IF061B-E	1 PC Board w/ Case
	PAC-IF062B-E	1 PC Board w/ Case
	PAC-IF063B-E	1 PC Board w/ Case
	PAC-SIF051B-E	1 PC Board w/ Case

Note: SUHZ CANNOT be connected to these IFs.

Combination table

Type	Model name	Package type								Split type						
		Power Inverter						ZUBADAN		Eco Inverter	Power Inverter					
		PUHZ-W50VHA2	PUHZ-W85VHA2	PUHZ-W112VHA	PUHZ-W60VAA	PUHZ-W85VAA/YAA	PUHZ-W112VAA/YAA	PUHZ-HW112YHA2	PUHZ-HW140VHA2/YHA2		SUHZ-SW45VA(H)	PUHZ-SW50VKA	PUHZ-SW75VAA	PUHZ-SW75YAA	PUHZ-SW100VAA	PUHZ-SW100YAA
Cylinder unit	EHST20C-VM2C														●	●
	EHST20C-VM6C														●	●
	EHST20C-YM9C														●	●
	EHST20C-TM9C														●	●
	EHST20C-VM2EC														●	●
	EHST20C-VM6EC														●	●
	EHST20C-YM9EC														●	●
	EHST20C-MEC														●	●
	EHST20C-MHCW														●	●
	EHST20D-VM2C										●	●	●	●		
	EHST20D-MEC										●	●	●	●		
	EHST20D-MHC										●	●	●	●		
	EHST20D-MHCW										●	●	●	●		
	EHST20D-VM2EC										●	●	●	●		
	EHST20D-YM9C										●	●	●	●		
	ERST20C-MEC														●	●
	ERST20C-VM2C														●	●
	ERST20D-MEC										●	●	●	●		
	ERST20D-VM2C										●	●	●	●		
	EHPT20X-VM2C	●	●	●	●	●	●	●	●							
EHPT20X-VM6C	●	●	●	●	●	●	●	●								
EHPT20X-YM9C	●	●	●	●	●	●	●	●								
EHPT20X-TM9C	●	●	●		●	●	●	●								
EHPT20X-MHCW	●	●	●		●	●	●	●								
Hydro box	EHSC-VM2C														●	●
	EHSC-VM2EC														●	●
	EHSC-VM6C														●	●
	EHSC-VM6EC														●	●
	EHSC-YM9C														●	●
	EHSC-YM9EC														●	●
	EHSC-TM9C														●	●
	EHSC-MEC														●	●
	EHSD-VM2C										●	●	●	●		
	EHSD-YM9C										●	●	●	●		
	EHSD-MEC										●	●	●	●		
	EHSD-MC										●	●	●	●		
	ERSC-VM2C														●	●
	ERSC-MEC														●	●
	ERSD-VM2C										●	●	●	●		
	EHPX-VM2C	●	●	●	●	●	●	●	●							
	EHPX-VM6C	●	●	●		●	●	●	●							
	EHPX-YM9C	●	●	●	●	●	●	●	●							
	EHSE-YM9EC															
	EHSE-MEC															
ERSE-YM9EC																
ERSE-MEC																

Split type														ATA/ATW Hybrid system			
					ZUBADAN									Mr. SLIM+	PUMY+ecodan		
PUHZ-SW75VHA	PUHZ-SW100VHA/YHA	PUHZ-SW120VHA/YHA	PUHZ-SW160YKA	PUHZ-SW200YKA	PUHZ-SHW80VAA	PUHZ-SHW80YAA	PUHZ-SHW112VAA	PUHZ-SHW112YAA	PUHZ-SHW80VHA	PUHZ-SHW112VHA/YHA	PUHZ-SHW140YHA	PUHZ-SHW230YKA2	PUHZ-FRP71VHA2	PUMY-P112VKM4/YKM(E)4	PUMY-P125VKM4/YKM(E)4	PUMY-P140VKM4/YKM(E)4	
●	●	●			●	●	●	●	●	●	●		●	●	●	●	
●	●	●			●	●	●	●	●	●	●		●	●	●	●	
●	●	●			●	●	●	●	●	●	●		●	●	●	●	
●	●	●			●	●	●	●	●	●	●		●	●	●	●	
●	●	●			●	●	●	●	●	●	●		●	●	●	●	
●	●	●			●	●	●	●	●	●	●		●	●	●	●	
●	●	●			●	●	●	●	●	●	●		●	●	●	●	
●	●	●			●	●	●	●	●	●	●		●	●	●	●	
●	●	●			●	●	●	●	●	●	●		●	●	●	●	
●																	
●																	
●																	
●																	
●																	
●	●	●			●	●	●	●	●	●	●		●	●	●	●	
●	●	●			●	●	●	●	●	●	●		●	●	●	●	
●																	
●																	
●																	
●																	
●																	
●																	
●																	
●	●	●			●	●	●	●	●	●	●		●	●	●	●	
●	●	●			●	●	●	●	●	●	●		●	●	●	●	
●																	
●																	
●																	
●																	
●																	
●																	
●	●	●			●	●	●	●	●	●	●		●	●	●	●	
●	●	●			●	●	●	●	●	●	●		●	●	●	●	
●																	
●																	
●																	
●																	
			●	●									●				
			●	●									●				
			●	●									●				
			●	●									●				

● : Combination is available. Blank : Combination is NOT available.

Mr. SLIM+

A smart air conditioning and hot water supply system conceived from eco-conscious ideas

Mr. SLIM+ has a heat recovery function, which uses waste heat from air conditioners to heat water. Thanks to heat recovery, the Mr. SLIM+ model can achieve a COP of 7.0*, resulting in intelligent systems with amazing efficiency.

*Conditions for air-to-air cooling: Indoor 27°C (dry bulb), 19°C (wet bulb); Outdoor 35°C (dry bulb)

1 unit, 2 roles – Total comfort year-round

Air conditioning and hot water supply matching the needs of each room

All-in-one outdoor unit (air conditioning, domestic hot water supply and hot water heating)

Mr. SLIM for Air-to-Air

Mr. SLIM+ utilises a duct system that enables the air conditioning or heating of multiple rooms, and other indoor unit type systems that it is possible to fit to various applications.

ecodan for Air-to-Water

- ✓ Domestic hot water (DHW) supply
- ✓ Heating for multiple rooms



Various operations

Mr. SLIM / ATA (Air Cooling)

Cooling using ATA indoor unit

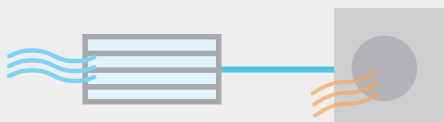

Mr. SLIM / ATA (Air Heating)

Heating using ATA indoor unit



ecodan / ATW (Hot water heating + DHW)

Heating and DHW using ATW indoor unit

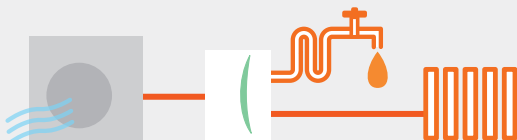

Mr. SLIM + ecodan / ATA (Air Cooling) + DHW

Heat recovery using both ATA and ATW indoor units

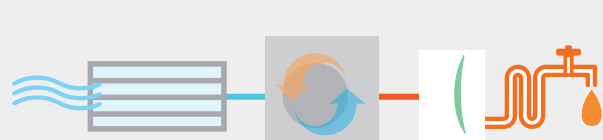

Specifications

Indoor unit				PLA-ZM71EA	PKA-M71KAL	PCA-M71KA	PSA-RP71KA	PEAD-M71JA	PEAD-M71JAL		
Outdoor unit				PUHZ-FRP71VHA2	PUHZ-FRP71VHA2	PUHZ-FRP71VHA2	PUHZ-FRP71VHA2	PUHZ-FRP71VHA2	PUHZ-FRP71VHA2		
Refrigerant				R410A							
Power supply		Outdoor (V / Phase / Hz)		230 / Single / 50							
Air-to-Air (ATA)	Cooling	Capacity	Rated	kW	7.1	7.1	7.1	7.1	7.1	7.1	
			Min-Max	kW	3.3-8.1	3.3-8.1	3.3-8.1	3.3-8.1	3.3-8.1	3.3-8.1	
		Total input	Rated	kW	1.88	1.93	1.93	2.15	2.10	2.04	
			EER		3.77	3.67	3.67	3.30	3.38	3.48	
		Design load	kW	7.1	7.1	7.1	7.1	7.1	7.1		
		Annual electricity consumption *1	kWh/a	376	386	384	409	444	427		
		SEER *3			6.6	6.4	6.4	6.0	5.5	5.8	
			Energy-efficiency class		A++	A++	A++	A+	A	A+	
		Heating (average season)	Capacity	Rated	kW	8.0	8.0	8.0	8.0	8.0	8.0
				Min-Max	kW	3.5-10.2	3.5-10.2	3.5-10.2	3.5-10.2	3.5-10.2	3.5-10.2
	Total input		Rated	kW	2.11	2.29	2.29	2.42	2.11	2.11	
			COP		3.80	3.50	3.50	3.30	3.79	3.79	
	Design load		kW	4.7	4.7	4.7	4.7	4.9	4.9		
	Declared capacity		at reference design temperature	kW	4.7 (-10°C)	4.7 (-10°C)	4.7 (-10°C)	4.7 (-10°C)	4.9 (-10°C)	4.9 (-10°C)	
			at bivalent temperature	kW	4.7 (-10°C)	4.7 (-10°C)	4.7 (-10°C)	4.7 (-10°C)	4.9 (-10°C)	4.9 (-10°C)	
			at operation limit temperature	kW	3.5 (-20°C)	3.5 (-20°C)	3.5 (-20°C)	3.5 (-20°C)	3.7 (-20°C)	3.7 (-20°C)	
	Back-up heating capacity		kW	0	0	0	0	0	0		
	Annual electricity consumption *1		kWh/a	1,509	1,564	1,556	1,699	1,791	1,791		
	SCOP *3			4.3	4.2	4.2	3.8	3.8	3.8		
		Energy-efficiency class		A+	A+	A+	A	A	A		
Air-to-Water (ATW)	Nominal flow rate (for heating)			L/min	22.90						
	Heating *4	A7W35	Capacity	kW	8.00	8.00	8.00	8.00	8.00	8.00	
			Input	kW	1.98	1.98	1.98	1.98	1.98	1.98	
			COP		4.05	4.05	4.05	4.05	4.05	4.05	
		A2W35	Capacity	kW	7.50	7.50	7.50	7.50	7.50	7.50	
			Input	kW	2.67	2.67	2.67	2.67	2.67	2.67	
			COP		2.81	2.81	2.81	2.81	2.81	2.81	
	Heat recovery (ATA cooling & ATW) *5	W45	Capacity (ATA cooling + ATW)	kW	7.1+8.0	7.1+8.0	7.1+8.0	7.1+8.0	7.1+8.0	7.1+8.0	
			Input	kW	1.90	1.93	1.95	2.02	2.15	2.13	
			COP		7.95	7.82	7.74	7.48	7.02	7.09	
		W55	Capacity (ATA cooling + ATW)	kW	7.1+9.0	7.1+9.0	7.1+9.0	7.1+9.0	7.1+9.0	7.1+9.0	
			Input	kW	2.97	3.00	3.02	3.09	3.22	3.20	
			COP		5.42	5.37	5.33	5.21	5.00	5.03	
	ATW indoor unit				Cylinder unit or Hydro box (see previous page)						
	Outdoor unit	Dimensions	HxWxD	mm	943-950-330 (+30)						
Weight			kg	73	73	73	73	73	73		
Air volume		Cooling	m ³ /min	50	50	50	50	50	50		
		Heating	m ³ /min	50	50	50	50	50	50		
Sound pressure level (SPL)		Cooling	dB(A)	47	47	47	47	47	47		
		Heat recovery	dB(A)	47	47	47	47	47	47		
		ATA Heating	dB(A)	49	49	49	49	49	49		
		ATW Heating	dB(A)	49	49	49	49	49	49		
Sound power level (PWL)		Cooling	dB(A)	67	67	67	67	67	67		
		Heat recovery	dB(A)	67	67	67	67	67	67		
		ATA Heating	dB(A)	68	68	68	68	68	68		
		ATW Heating	dB(A)	68	68	68	68	68	68		
Operating current (max)			A	19.0	19.0	19.0	19.0	19.0	19.0		
Breaker size		A	25	25	25	25	25	25			
Ext.piping	Diameter	Liquid/Gas	mm	9.52/15.88	9.52/15.88	9.52/15.88	9.52/15.88	9.52/15.88	9.52/15.88		
	Max. length	Out-In	m	30 (for ATA) + 30 (for ATW)							
	Max. height	Out-In	m	20	20	20	20	20	20		
Guaranteed operating range (outdoor)	Cooling *2	°C	-15~+46	-15~+46	-15~+46	-15~+46	-15~+46	-15~+46			
	Heating	°C	-20~+21	-20~+21	-20~+21	-20~+21	-20~+21	-20~+21			
	ATW	°C	-20~+35	-20~+35	-20~+35	-20~+35	-20~+35	-20~+35			
	Heat recovery	°C	+7~+46	+7~+46	+7~+46	+7~+46	+7~+46	+7~+46			

*1 Energy consumption based on standard test results. Actual energy consumption will depend on how the appliance is used and where it is located.

*2 Optional air protection guide is required where ambient temperature is lower than -5°C.

*3 SEER/SCOP values are measured based on EN14825.

*4 Air-to-Water values are measured based on EN14511 (Circulation pump input is not included.).

*5 Conditions for Air-to-Air cooling: Indoor 27°C (dry bulb) /19°C (wet bulb); Outdoor 35°C (dry bulb).

PUMY+ecodan

Air-to-Air and Air-to-Water hybrid multi split system

1 unit, 2 roles – Total comfort year-round

Air conditioning and hot water supply matching the needs of each room

All-in-one outdoor unit (air conditioning, domestic hot water supply and hot water heating)

PUMY for Air-to-Air

PUMY utilises various indoor units, enabling the air conditioning or heating of multiple rooms, and controls each unit individually.

ecodan for Air-to-Water

- ✓ Domestic hot water (DHW) supply
- ✓ Heating for multiple rooms

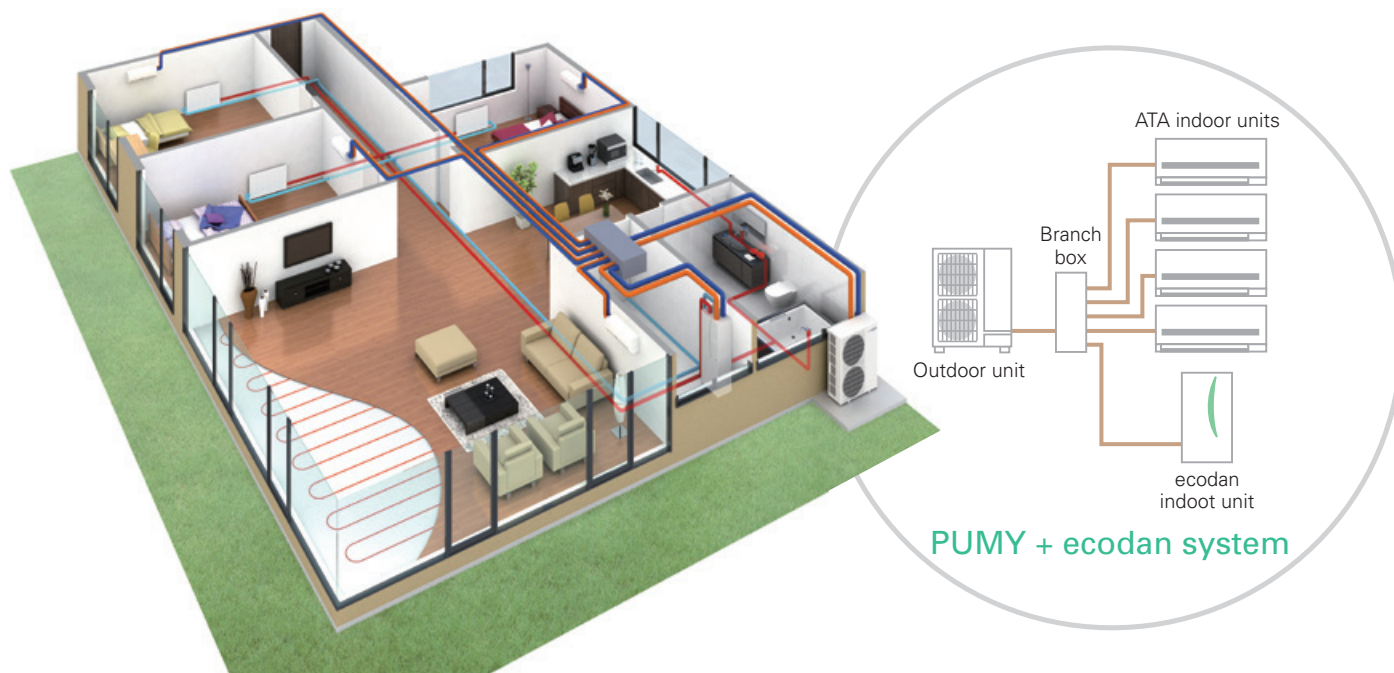

Main operation patterns

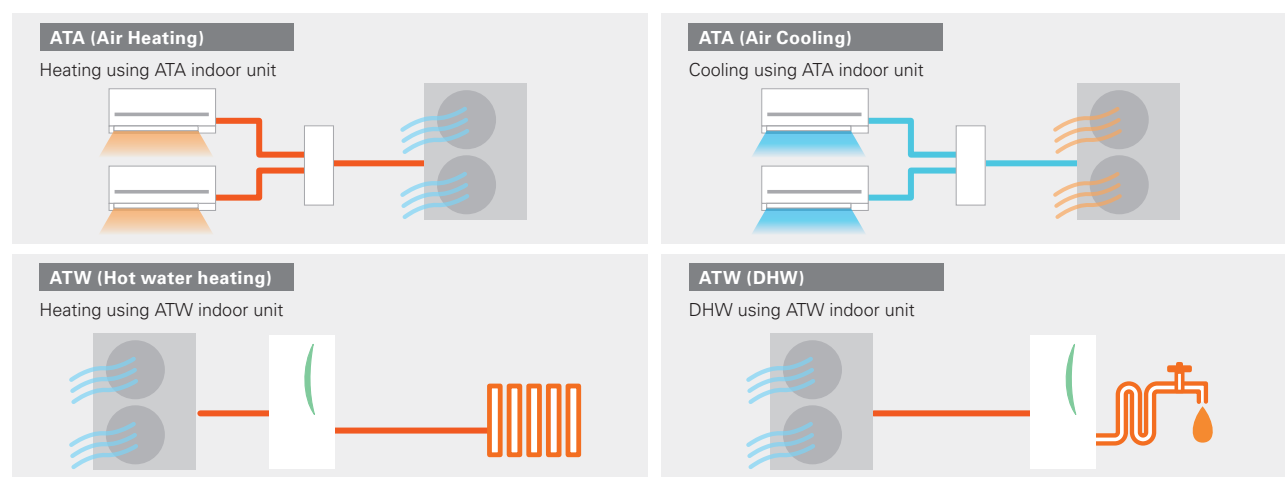

Optional operation patterns* (simultaneous)

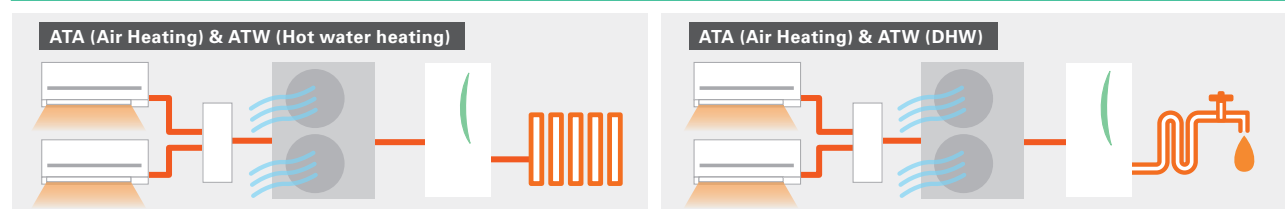

*When using optional simultaneous operation, there are some restrictions, such as connectable indoor units, operation range and DHW flow temp.

Usage pattern All-in-one system solution

Summer 2-in-1 operation

In summer ATA cooling and DHW are utilised. Keep your room comfortable with ATA cooling during high temperature daytime. Heat pump operates to heat up water stored in the DHW tank when ATA is not operated. The hot water can be utilised for shower and washing dishes during daytime.

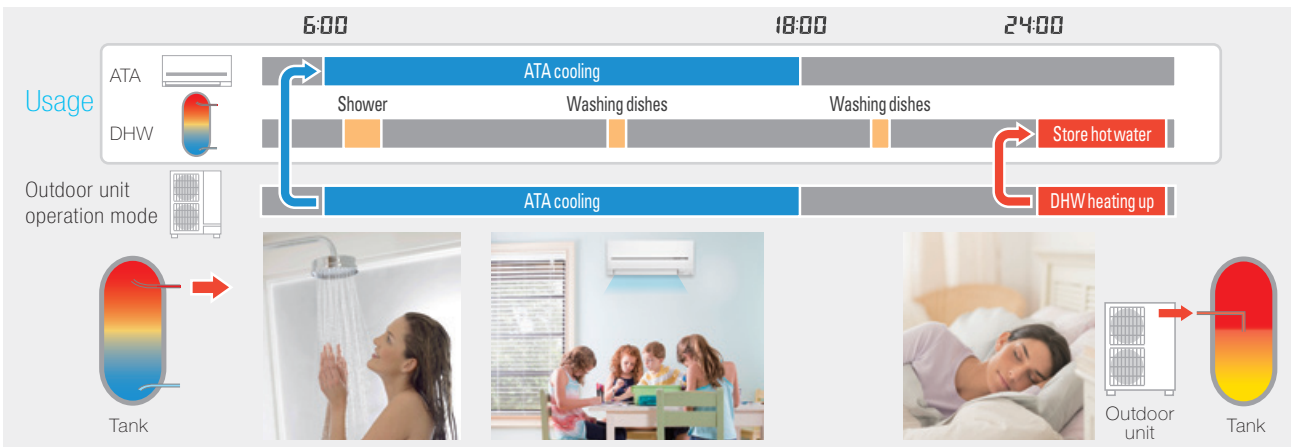

Spring & Autumn 2-in-1 operation

In spring and autumn, ATA heating and DHW are utilised. ATA heating can warm up each room quickly during the low temperature morning and evening. Heat pump operates to heat up water stored in the DHW tank when ATA is not operated. The hot water can be utilised for shower and washing dishes during daytime.



Winter ecodan

In winter ATW heating and DHW are utilised. ATW heating warms home all the day in severe cold weather. ATW heating stops temporarily only when the heat pump operates to heat up water stored in the DHW tank.

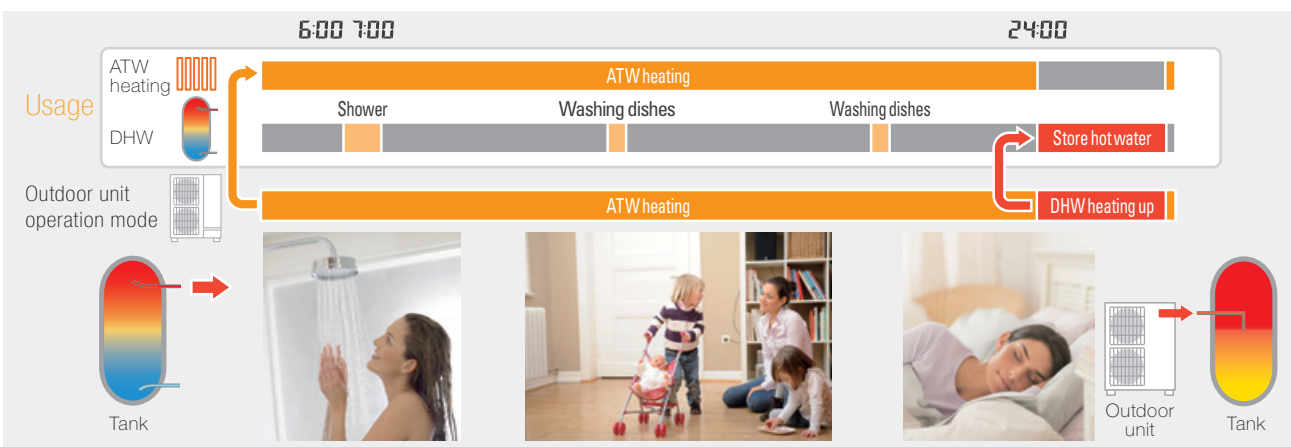

Model name				PUMY-P112VKM4(-BS)	PUMY-P125VKM4(-BS)	PUMY-P140VKM4(-BS)	PUMY-P112YKM(E)4(-BS)	PUMY-P125YKM(E)4(-BS)	PUMY-P140YKM(E)4(-BS)	
Power supply				1-phase 220 - 230 - 240V, 50Hz			3-phase 380 - 400 - 415V, 50Hz			
Air-to-Air (ATA)	Cooling (nominal)*1	Capacity	kW	12.5	14.0	15.5	12.5	14.0	15.5	
		Power input	kW	2.79	3.46	4.52	2.79	3.46	4.52	
		EER		4.48	4.05	3.43	4.48	4.05	3.43	
	Temp. range of cooling	Indoor temp.	W.B.	15 - 24°C						
		Outdoor temp.*2	D.B.	-5 - 52°C						
	Heating (nominal)*1	Capacity	kW	14.0	16.0	18.0	14.0	16.0	18.0	
		Power input	kW	3.04	3.74	4.47	3.04	3.74	4.47	
		COP		4.61	4.28	4.03	4.61	4.28	4.03	
Temp. range of heating	Indoor temp.	W.B.	15 - 27°C							
	Outdoor temp.	D.B.	-20 - 15°C							
Air-to-Water (ATW)	Nominal flow rate (for heating)			L/min	35.8					
	Heating*3	A7W35	Capacity	kW	12.5					
			Power input	kW	3.06					
			COP		4.08					
	A2W35	Capacity	kW	10.0						
		Power input	kW	3.50						
		COP		2.86						
	Guaranteed operating range	ATW	Heating	D.B.	-20 - +21°C					
			DHW	D.B.	-20 - +35°C					
			ATA heating + DHW	D.B.	7 - +21°C					
	ATA + ATW	ATA heating + ATW heating *4	D.B.	-10 - +21°C						
		Maximum Outlet water temp.			°C	55				
Outdoor unit	Indoor unit connectable	ATA only	Total capacity		50 to 130% of outdoor unit capacity					
			Model/Quantity	Branch box system	15-100/8	15-100/8	15-100/8	15-100/8	15-100/8	15-100/8
				Mixed system*12	15-140*5/10	15-140*5/10*6	15-140*5/10*6	15-140*5/10	15-140*5/10*6	15-140*5/10*6
	ATA + ATW individual operation	Model/Quantity (including ATW)	Total capacity		ATA : Max 130% of outdoor unit capacity + ATW (EHST20C or EHSC) *7					
			Branch box system	15-100/8	15-100/8	15-100/8	15-100/8	15-100/8	15-100/8	
			Mixed system*12	15-140*5/10	15-140*5/10*6	15-140*5/10*6	15-140*5/10	15-140*5/10*6	15-140*5/10*6	
	ATA + ATW simultaneous operation	Model/Quantity	Total capacity		Max 100% of outdoor unit capacity : ATA + ATW (EHST20C or EHSC) *7					
			ATA*12	15/1*8	15-25/2*9	15-42*11/3*10	15/1*8	15-25/2*9	15-42*11/3*10	
			ATW	ATW (EHST20C or EHSC) / 1						
	Sound pressure level (measured in anechoic room)			dB<A>	49 / 51	50 / 52	51 / 53	49 / 51	50 / 52	51 / 53
	Sound power level (measured in anechoic room)			dB<A>	69 / 71	70 / 72	71 / 73	69 / 71	70 / 72	71 / 73
	Refrigerant piping diameter			Liquid pipe	9.52 flare					
				Gas pipe	15.88 flare					
	Fan	Type x Quantity		Propeller fan x 2						
		Airflow rate		m³/min	110					
		L/s	1,883							
		cfm	3,884							
Compressor	Motor output		0.074 + 0.074							
	Type x Quantity		Scroll hermetic compressor x 1							
	Starting method		Inverter							
Motor output			kW	2.9	3.5	3.9	2.9	3.5	3.9	
External dimensions (H x W x D)			mm	1,338 x 1,050 x 330 (+40)						
Weight			kg	122			YKM: 125 / YKME: 136			

*1

	Indoor	Outdoor	Piping length	Level difference
Cooling	27°C DB / 19°C WB	35°C DB	7.5m	0m
Heating	20°C DB	7°C DB / 6°C WB	7.5m	0m

- *2 10 to 52°C D.B.: When connecting PKFY-P15/20/25VBM, PFFY-P20/25/32VKM, PFFY-P20/25/32VLE(R)M, PEFY-P*VMA3 or M, S and P series indoor unit.
- *3 In the case of ATW single connection. Input to circulation pump is not included.
- *4 In the case of simultaneous operation of ATA heating and ATW heating, target flow temperature range is restricted to 45-55°C and when the ambient temp is under 7°C, the flow temp is lowered.
- *5 Up to P100 when connecting via branch box.
- *6 Up to 11 units when connecting via 2 branch boxes.
- *7 Only one ecodan unit can be connected.
- *8 Exceptionally, one MSZ-SF15VA or MSZ-AP15VF can be connected.
- *9 Exceptionally, two MSZ-SF15VA or MSZ-AP15VF can be connected.
- *10 Exceptionally, three MSZ-SF15VA or MSZ-AP15VF can be connected.
- *11 In the case of City Multi connection, maximum is P32.
- *12 PKFY and PFFY series are not connectable.

Piping specifications

Total piping length	m	150*	a+b+c+d+e+f
Farthest piping length	m	80	a+b+d or a+c+e
		85	a+f
Total piping length between outdoor unit and branch box	m	55	a+b+c
Total piping length between branch boxes and indoor units	m	95	d+e
Farthest piping length from the first joint	m	30	b or c or f
Farthest piping length after branch box	m	25	d or e
Height difference (Outdoor upside / Outdoor downside)	m	50 / 40	

*When an ecodan is connected, the maximum piping length is 150m.

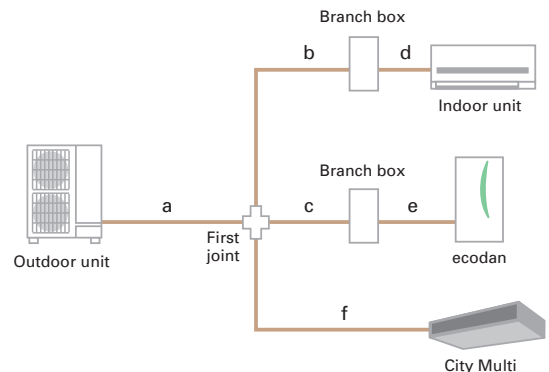

PUMY+ ecodan compatibility table

ATW branch box connection compatibility table

Series	Type	Model name	Compatibility	Type	Model name	Compatibility	Type	Model name	Compatibility
ATW	Cylinder unit	EHST20C-VM2/6C	●	Hydro box	EHSC-VM2(E)C	●	Branch box	PAC-MK53BC	●
		EHST20C-YM9C	●		EHSC-VM6(E)C	●		PAC-MK33BC	●
		EHST20C-TM9C	●		EHSC-YM9(E)C	●		PAC-MK53BCB	●
		EHST20C-VM2/6EC	●		EHSC-TM9C	●		PAC-MK33BCB	●
		EHST20C-YM9EC	●						
		EHST20C-MHCW	●*						

*Please be sure to use brine water.

Branch box connection compatibility table

Series	Type	Model name	Compatibility											
			15	18	20	22	25	35	42	50	60	71	100	
M series	Wall-mounted	MSZ-LN•VG					●	●						
		MSZ-AP•VF/VG	●		●		●	●	●	●				
		MSZ-FH•VE2					●	●		●				
		MSZ-EF•VE3		●		●	●	●	●	●				
		MSZ-SF•VA	●		●									
		MSZ-SF•VE3					●	●	●	●				
	MSZ-GF•VE2										●	●		
	Floor-standing	MFZ-KJ•VE2					●	●		●				
	1-way cassette	MLZ-KP•VF					●	●		●				
S series	Ceiling-concealed	SEZ-M•DA(L)					●	●		●	●	●		
	2x2 cassette	SLZ-M•FA	●				●	●		●				
P series	Ceiling-suspended	PCA-M•KA						●		●	●	●	●	
	4-way cassette	PLA-M•EA						●		●	●	●	●	
	Ceiling-concealed	PEAD-M•JA(L)								●	●	●	●	

LEV kit connection compatibility table

Series	I/U type	Model name	Compatibility										
			15	18	20	22	25	35	42	50	60	71	
M series	Wall-mounted	MSZ-LN•VG					●	●					
		MSZ-AP•VF/VG	●		●		●	●	●	●			
		MSZ-FH•VE2					●	●		●			
		MSZ-EF•VE3		●		●	●	●	●	●			
		MSZ-SF•VA	●		●								
	MSZ-SF•VE3					●	●	●	●				
	Floor-standing	MFZ-KJ•VE2					●	●		●			

Connectable indoor unit capacity

For individual operation ATA+ATW (no simultaneous operation) ATA: Max 130% of outdoor unit capacity + ATW (EHST20C or EHSC)

Outdoor capacity 12.5kW	ATW indoor unit (Cylinder or Hydro box) 11.2kW	Connectable ATA indoor unit total capacity: Max.16.2kW (130%)
Outdoor capacity 14.0kW	ATW indoor unit (Cylinder or Hydro box) 11.2kW	Connectable ATA indoor unit total capacity: Max.18.2kW (130%)
Outdoor capacity 15.5kW	ATW indoor unit (Cylinder or Hydro box) 11.2kW	Connectable ATA indoor unit total capacity: Max.20.2kW (130%)

For simultaneous operation of ATA+ATW Max 100% of outdoor unit capacity: ATA + ATW (EHST20C or EHSC)

Outdoor capacity 12.5kW	ATW indoor unit (Cylinder or Hydro box) 11.2kW	ATA capacity Max. 1.3kW	*Exceptionally, one MSZ-SF15VA or MSZ-AP15VF can be connected.
Outdoor capacity 14.0kW	ATW indoor unit (Cylinder or Hydro box) 11.2kW	ATA capacity Max. 2.8kW	*Exceptionally, two units of MSZ-SF15VA or MSZ-AP15VF can be connected.
Outdoor capacity 15.5kW	ATW indoor unit (Cylinder or Hydro box) 11.2kW	ATA capacity Max. 4.3kW	*Exceptionally, three units of MSZ-SF15VA or MSZ-AP15VF can be connected.

MELCloud (Wi-Fi interface) for ecodan

MELCloud for fast, easy remote control and monitoring of your ecodan

MELCloud is a new Cloud-based solution for controlling ecodan either locally or remotely by computer, tablet or smartphone via the Internet. Setting up and remotely operating your ecodan heating system via MELCloud is simple and straight forward. All you need is wireless computer connectivity in your home or the building where the ecodan is installed and an Internet connection on your mobile or fixed terminal. To set up the system, the router and the ecodan WiFi interface must be paired, and this is done simply and quickly using the WPS button found on all mainstream routers.

You can control and check ecodan via MELCloud from virtually anywhere an Internet connection is available. That means, thanks to MELCloud, you can use ecodan much more easily and conveniently.



Key control and monitoring features

- 1 Turn system on/off**
- 2 See status of each of your heating zones & adjust set points**
- 3 See the status of your hot water cylinder & boost remotely**
- 4 Live weather feed from ecodan location**
 - Holiday mode - Set system parameters while away
 - Schedule timer - Set 7 day weekly schedule
 - Frost protection - Set system to run at minimum temperature
 - Error status
- 5 Check energy usage report*** *Additional metering hardware is required.



All A++ line-up!!

*except for ATA & ATW hybrid system, Mr. SLIM+

Outdoor unit	Indoor unit	Seasonal space heating energy efficiency class	Water heating energy efficiency class	For medium-temperature application					For low-temperature application						
				Rated heat output under average climate conditions	Seasonal space heating energy efficiency under average climate conditions	Water heating energy efficiency under average climate conditions	Sound power level LWA indoor	Sound power level LWA outdoor	Rated heat output under average climate conditions	Seasonal space heating energy efficiency under average climate conditions	Water heating energy efficiency under average climate conditions	Sound power level LWA indoor	Sound power level LWA outdoor		
				kW	%	%	dB	dB	kW	%	%	dB	dB		
SUHZ-SW45VA(-H)	EHST20D-****	A++	A	4.6	126	109	40	61	A++	A	5.0	170	109	40	61
	ERST20D-****	A++	A	4.6	128	109	40	61	A++	A	5.0	174	109	40	61
	EHSD-****	A++	-	4.6	126	-	40	61	A++	-	5.0	170	-	40	61
	ERSD-****	A++	-	4.6	128	-	40	61	A++	-	5.0	174	-	40	61
PUHZ-SW50VKA(-BS)	EHST20D-****	A++	A	4.3	125	98	40	63	A++	A	4.5	163	98	40	63
	ERST20D-****	A++	A	4.3	128	98	40	63	A++	A	4.5	167	98	40	63
	EHSD-****	A++	-	4.3	125	-	40	63	A++	-	4.5	163	-	40	63
	ERSD-****	A++	-	4.3	128	-	40	63	A++	-	4.5	167	-	40	63
PUHZ-SW75VAA/YAA(-BS)	EHST20D-****	A++	A	7.1	129/128	104	40	58	A++	A	7.2	162/160	104	40	58
	ERST20D-****	A++	A	7.1	132/132	104	40	58	A++	A	7.2	166/165	104	40	58
	EHSD-****	A++	-	7.1	129/128	-	40	58	A++	-	7.2	162/160	-	40	58
	ERSD-****	A++	-	7.1	132/132	-	40	58	A++	-	7.2	166/165	-	40	58
PUHZ-SW100VAA/YAA(-BS)	EHST20C-****	A++	A	10.0	130/129	103	40	60	A++	A	7.2	167/165	103	40	60
	ERST20C-****	A++	A	10.0	132/132	103	40	60	A++	A	7.2	170/169	103	40	60
	EHSC-****	A++	-	10.0	130/129	-	40	60	A++	-	7.2	167/165	-	40	60
	ERSC-****	A++	-	10.0	132/130	-	40	60	A++	-	7.2	170/169	-	40	60
PUHZ-SW75VHA(-BS)	EHST20D-****	A++	A	7.1	127	100	40	68	A++	A	7.2	164	100	40	68
	ERST20D-****	A++	A	7.1	129	100	40	68	A++	A	7.2	166	100	40	68
	EHSD-****	A++	-	7.1	127	-	40	68	A++	-	7.2	164	-	40	68
	ERSD-****	A++	-	7.1	129	-	40	68	A++	-	7.2	166	-	40	68
PUHZ-SW75VHA(-BS)	EHST20C-****	A++	A	7.1	127	103	40	68	A++	A	7.2	165	103	40	68
	ERST20C-****	A++	A	7.1	129	103	40	68	A++	A	7.2	167	103	40	68
	EHSC-****	A++	-	7.1	127	-	40	68	A++	-	7.2	165	-	40	68
	ERSC-****	A++	-	7.1	129	-	40	68	A++	-	7.2	167	-	40	68
PUHZ-SW100VHA/YHA(-BS)	EHST20C-****	A++	A	10.0	125/125	103	40	70	A++	A	10.4	164/163	103	40	70
	ERST20C-****	A++	A	10.0	127/127	103	40	70	A++	A	10.4	166/166	103	40	70
	EHSC-****	A++	-	10.0	125/125	-	40	70	A++	-	10.4	164/163	-	40	70
	ERSC-****	A++	-	10.0	127/127	-	40	70	A++	-	10.4	166/166	-	40	70
PUHZ-SW120VHA/YHA(-BS)	EHST20C-****	A++	A	12.0	125/125	99	40	72	A++	A	12.9	162/162	99	40	72
	ERST20C-****	A++	A	12.0	127/127	99	40	72	A++	A	12.9	164/164	99	40	72
	EHSC-****	A++	-	12.0	125/125	-	40	72	A++	-	12.9	162/162	-	40	72
	ERSC-****	A++	-	12.0	127/127	-	40	72	A++	-	12.9	164/164	-	40	72
PUHZ-SW160YKA(-BS)	EHSE-****	A++	-	13.5	125	-	45	78	A++	-	15.3	161	-	45	78
	ERSE-****	A++	-	13.5	126	-	45	78	A++	-	15.3	163	-	45	78
	EHPX-****	A++	-	15.5	128	-	45	78	A++	-	17.3	162	-	45	78
PUHZ-SW200YKA(-BS)	EHSE-****	A++	-	15.5	129	-	45	78	A++	-	17.3	164	-	45	78
	ERSE-****	A++	-	15.5	129	-	45	78	A++	-	17.3	164	-	45	78
	EHPX-****	A++	-	9.0	133/132	103	40	59	A++	A	9.6	169/167	103	40	59
	ERST20C-****	A++	A	9.0	135/134	103	40	59	A++	A	9.6	172/172	103	40	59
PUHZ-SHW80VAA/YAA(-BS)	EHSC-****	A++	-	9.0	133/132	-	40	59	A++	-	9.6	169/167	-	40	59
	ERSC-****	A++	-	9.0	135/134	-	40	59	A++	-	9.6	172/172	-	40	59
	EHPX-****	A++	-	12.7	137/137	-	40	60	A++	-	13.9	173/173	-	40	60
	ERST20C-****	A++	A	12.7	137/137	103	40	60	A++	A	13.9	173/173	103	40	60
PUHZ-SHW112VAA/YAA(-BS)	EHSC-****	A++	-	12.7	135/135	-	40	60	A++	-	13.9	171/169	-	40	60
	ERSC-****	A++	-	12.7	137/137	-	40	60	A++	-	13.9	173/173	-	40	60
	EHPX-****	A++	-	12.7	137/137	-	40	60	A++	-	13.9	173/173	-	40	60
	ERST20C-****	A++	A	9.0	131	103	40	69	A++	A	9.6	171	103	40	69
PUHZ-SHW80VHA(-BS)	ERST20C-****	A++	A	9.0	133	103	40	69	A++	A	9.6	174	103	40	69
	EHSC-****	A++	-	9.0	131	-	40	69	A++	-	9.6	171	-	40	69
	ERSC-****	A++	-	9.0	133	-	40	69	A++	-	9.6	174	-	40	69
	EHPX-****	A++	-	12.7	128/128	-	40	70	A++	-	13.9	167/167	-	40	70
PUHZ-SHW112VHA/YHA(-BS)	ERST20C-****	A++	A	12.7	128/128	103	40	70	A++	A	13.9	167/167	103	40	70
	EHSC-****	A++	-	12.7	128/128	-	40	70	A++	-	13.9	167/167	-	40	70
	ERSC-****	A++	-	12.7	130/130	-	40	70	A++	-	13.9	169/169	-	40	70
	EHPX-****	A++	-	15.8	127	103	40	70	A++	A	17.0	164	103	40	70
PUHZ-SHW140VHA(-BS)	ERST20C-****	A++	A	15.8	128	103	40	70	A++	A	17.0	165	103	40	70
	EHSC-****	A++	-	15.8	127	-	40	70	A++	-	17.0	164	-	40	70
	ERSC-****	A++	-	15.8	128	-	40	70	A++	-	17.0	165	-	40	70
	EHPX-****	A++	-	23.0	127	-	45	75	A++	-	25.0	164	-	45	75
PUHZ-SHW230YKA2	ERSE-****	A++	-	23.0	128	-	45	75	A++	-	25.0	165	-	45	75
	EHPX-****	A++	-	5.0	127	-	40	61	A++	-	5.0	162	-	40	61
	EHPX-****	A++	-	5.0	127	-	40	61	A++	-	5.0	162	-	40	61
PUHZ-W50VHA2(-BS)	EHPX-****	A++	-	8.5	128	97	40	66	A++	A	8.5	162	97	40	66
	EHPX-****	A++	-	8.5	128	-	40	66	A++	-	8.5	162	-	40	66
	EHPX-****	A++	-	10.0	125	100	40	69	A++	A	10.0	164	100	40	69
PUHZ-W112VHA(-BS)	EHPX-****	A++	-	10.0	125	-	40	69	A++	-	10.0	164	-	40	69
	EHPX-****	A++	-	10.0	125	-	40	69	A++	-	10.0	164	-	40	69
	EHPX-****	A++	-	10.0	125	-	40	69	A++	-	10.0	164	-	40	69
PUHZ-W60VAA(-BS)	EHPX-****	A++	-	6.0	129	104	40	58	A++	A	6.0	182	104	40	58
	EHPX-****	A++	-	6.0	129	-	40	58	A++	-	6.0	182	-	40	58
	EHPX-****	A++	-	8.5	137/136	104	40	58	A++	A	8.5	171/169	104	40	58
PUHZ-W85VAA/YAA(-BS)	EHPX-****	A++	-	8.5	137/136	-	40	58	A++	-	8.5	171/169	-	40	58
	EHPX-****	A++	-	10.0	133/132	100	40	60	A++	A	10.0	170/169	100	40	60
	EHPX-****	A++	-	10.0	133/132	-	40	60	A++	-	10.0	170/169	-	40	60
PUHZ-W112VAA/YAA(-BS)	EHPX-****	A++	-	10.0	133/132	100	40	60	A++	A	10.0	170/169	100	40	60
	EHPX-****	A++	-	10.0	133/132	-	40	60	A++	-	10.0	170/169	-	40	60
	EHPX-****	A++	-	10.0	133/132	-	40	60	A++	-	10.0	170/169	-	40	60
PUHZ-HW112YHA2(-BS)	EHPX-****	A++	-	12.7	127	100	40	67	A++	A	12.7	155	100	40	67
	EHPX-****	A++	-	12.7	127	-	40	67	A++	-	12.7	155	-	40	67
	EHPX-****	A++	-	15.8	126/126	96	40	67	A++	A	15.8	157/157	96	40	67
PUHZ-HW140VHA2/YHA2(-BS)	EHPX-****	A++	-	15.8	126/126	-	40	67	A++	-	15.8	157/157	-	40	67
	EHPX-****	A++	-	15.8	126/126	-	40	67	A++	-	15.8	157/157	-	40	67
	EHPX-****	A++	-	15.8	126/126	-	40	67	A++	-	15.8	157/157	-	40	67
PUHZ-FRP71VHA2 ATA&ATW hybrid system, Mr.SLIM+	EHST20C-****	A+	A	7.5	123	98	40	68	A++	A	7.5	163	98	40	68
	EHSC-****	A+	-	7.5	123	-	40	68	A++	-	7.5	163	-	40	68
PUMY-P112VKM3/YKM(E)4-BS	EHST20C-****	A+	A	11.2	121/121	75	40	69	A++	A	11.2	168/168	75	40	69
	EHSC-****	A+	-	11.2	121/121	-	40	69	A++	-	11.2	168/168	-	40	69
	EHSC-****	A+	-	11.											

NEW ECODESIGN DIRECTIVE

WHAT IS THE ErP DIRECTIVE?

The Ecodesign Directive for Energy-related Products (ErP Directive) establishes a framework to set mandatory standards for ErPs sold in the European Union (EU). The ErP directive introduces new energy-efficiency ratings across various product categories and affects how products such as computers, vacuum cleaners, boilers and even windows are classified in terms of environmental performance.

Regulations that apply to air conditioning systems of rated capacity up to 12kW came into effect as of January 1, 2013. Based on the use of future-orientated technologies, Mitsubishi Electric is one step ahead of these changes, with our air conditioning systems already achieving compliance with these new regulations.

NEW ENERGY LABEL AND MEASUREMENTS

Under regulation 2011/626/EU, supplementing directive 2010/30/EU, air conditioning systems are newly classified into energy-efficiency classes on the basis of a new energy labelling system, which includes three new classes: A+, A++ and A+++.

Revisions to the measurement points and calculations of the seasonal energy efficiency ratio (SEER) and seasonal coefficient of performance (SCOP) has resulted in changes to how air conditioning systems are classified into energy-efficiency classes.

Specifically, for cooling mode, air conditioning systems must achieve at least class B. For heating mode, air conditioning systems must achieve at least a SCOP value of 3.8.

■ New Energy Efficiency Label

SEER and SCOP
The SEER (Seasonal Energy Efficiency Ratio) value indicates the seasonal energy efficiency value in the cooling mode. The SCOP (Seasonal Coefficient of Performance) value refers to the seasonal efficiency in the heating mode.

Energy efficiency classes from A+++ to D SCOP in heating mode

A+++	> 5,1
A++	> 4,6
A+	> 4,0
A	> 3,4
B	> 2,8
C	> 2,3
D	< 2,5

Energy efficiency classes from A+++ to D SEER in cooling mode

A+++	> 8,5
A++	> 6,1
A+	> 5,6
A	> 5,1
B	> 4,6
C	> 4,1
D	< 3,6

Energy efficiency class
Energy efficiency class of the unit in cooling and heating mode of the unit model

In the heating mode, the indication for the unit model is shown for all three climate zones.

Nominal capacity in cooling mode
SEER value
Annual power consumption for cooling

Operating noise, indoors/outdoors
The sound power level is an important sound energy parameter for assessing a sound source. Contrary to the sound pressure - the sound power is independent of the location of the source and/or the receiver. Maximally admissible values are:

Cooling capacity ≤ 6 kW		Cooling capacity > 6 kW ≤ 12 kW	
Indoor unit	Outdoor unit	Indoor unit	Outdoor unit
60dB(A)	65dB(A)	65dB(A)	70dB(A)

Name or trademark of the manufacturer
Name of the unit/designation of model

Time reference
Indication on label data

Nominal capacity in heating mode
SCOP value
Annual power consumption for heating

Climate zones
For heating mode, the EU is divided into three climate zones for calculation and classification purposes. This aims at calculating the energy efficiency taking into consideration the actual regional ambient temperatures.

■ Climate Zones for Heating Mode

Reference climate zones for calculating the SCOP
Since the climate conditions have a great influence on the operating behaviour in the heat pump mode, three climate zones have been stipulated for the EU: warm, moderate, cold. The measurement points are homogenous at 12°C, 7°C, 2°C and -7°C.

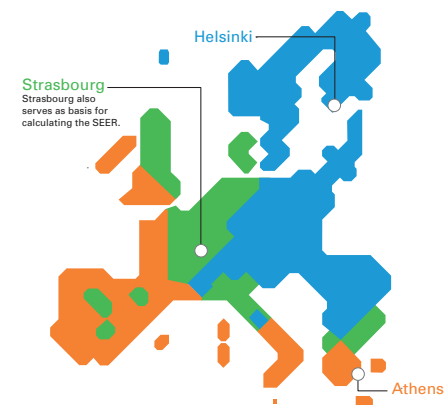

Warm (Athens)

Partial load	Temperature conditions		
	Outdoors	WB	Indoors
-	DB	WB	DB
100%	2°C	1°C	20°C
64%	7°C	6°C	20°C
29%	12°C	11°C	20°C

Moderate (Strasbourg)

Partial load	Temperature conditions		
	Outdoors	WB	Indoors
-	DB	WB	DB
88%	-7°C	-8°C	20°C
54%	2°C	1°C	20°C
35%	7°C	6°C	20°C
15%	12°C	11°C	20°C

Cold (Helsinki)

Partial load	Temperature conditions		
	Outdoors	WB	Indoors
-	DB	WB	DB
61%	-7°C	-8°C	20°C
37%	2°C	1°C	20°C
24%	7°C	6°C	20°C
11%	12°C	11°C	20°C

SEER/SCOP

Air conditioning systems were previously assessed using the energy-efficiency rating (EER), which evaluated efficiency in cooling mode, and the coefficient of performance (COP), which defined the efficiency, or the ratio of consumed and output power, in heating mode. Under this system, assessments were not truly reflective of performance as they were based on a single measurement point, which led to manufacturers optimising products accordingly in order to achieve higher efficiency ratings. SEER and SCOP address this problem by including seasonal variation in the ratings via use of realistic measurement points. For cooling mode, measurements at outside temperatures of 20, 25, 30 and 35°C are incorporated and weighted in accordance with climate data for Strasbourg, which is used as a single reference point for the whole EU. For instance, for partial-load operation, which represents more than 90% of operation, there is a correspondingly high weighting for the efficiency classification. For heating mode, a comprehensive temperature profile for the whole EU was not possible, so the EU has been divided into three climate zones, north, central and south, and load profiles created. The same measurement points, at outside temperatures of 12, 7, 2 and -7°C, are used for all three zones.

■ SCOP Calculation

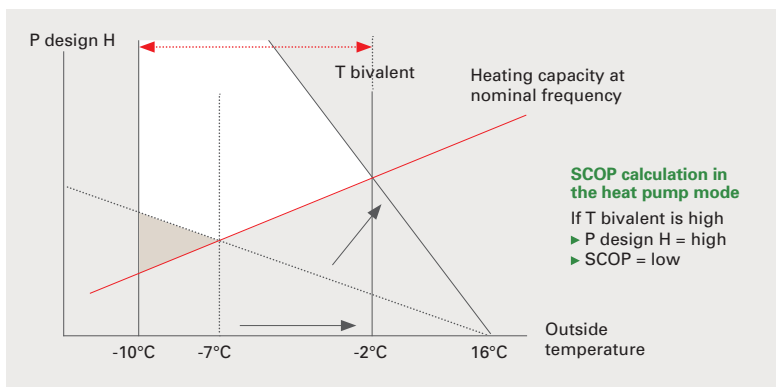

Technical Terms with Respect to the SCOP

P design H: Corresponds to a heating load of 100%. The value depends on the selected bivalence point.

T design: Outside temperature which determines the P design H point. The latter is determined from the area conditions.

T bivalent: Corresponds to the lowest temperature at which full heating performance can be achieved with the heat pump (without additional heating). This point can be freely selected within the prescribed temperature ranges (T design - T bivalent).

SOUND PRESSURE LEVEL

Consumers will also receive more information on the noise levels emitted by split-system air conditioners to help them make their purchasing decision. Specifically, the sound power level of indoor and outdoor units is to be indicated in decibels as an objective parameter. Knowing the sound power makes it possible to calculate sound emissions while considering distance and radiation characteristics, which is beneficial because it allows the noise levels of different air conditioning systems to be compared regardless of the usage location and how the sound pressure is measured. This is an improvement on sound pressure values which are usually measured at an approximate distance of 1 m where all modern split-system air conditioning systems tend to be very quiet at an average of 21 decibels.

■ Sound Pressure vs Sound Power Level

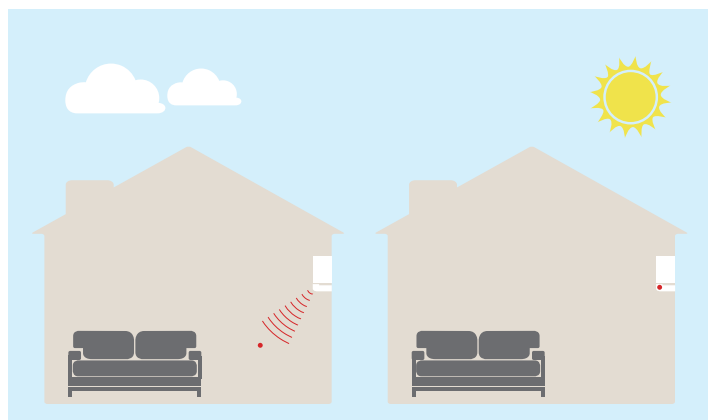

Sound pressure level dB(A)

The sound pressure level is a sound field parameter which indicates the perceived operating noise of an indoor unit within a certain distance.

Sound power level dB(A)

The sound power is an acoustic parameter which describes the source strength of a sound generator and is thus independent of the distance to the receiver location.



INVERTER TECHNOLOGIES

Mitsubishi Electric inverters ensure superior performance including the optimum control of operation frequency. As a result, optimum power is applied in all heating/cooling ranges and maximum comfort is achieved while consuming minimal energy. Fast, comfortable operation and amazingly low running cost — That's the Mitsubishi Electric promise.

INVERTERS – HOW THEY WORK

Inverters electronically control the electrical voltage, current and frequency of electrical devices such as the compressor motor in an air conditioner. They receive information from sensors monitoring operating conditions, and adjust the revolution speed of the compressor, which directly regulates air conditioner output. Optimum control of operation frequency results in eliminating the consumption of excessive electricity and providing the most comfortable room environment.

ECONOMIC OPERATION

Impressively low operating cost is a key advantage of inverter air conditioners. We've combined advanced inverter technologies with cutting-edge electronics and mechanical technologies to achieve a synergistic effect that enables improvements in heating/cooling performance efficiency. Better performance and lower energy consumption are the result.

TRUE COMFORT

Below is a simple comparison of air conditioner operation control with and without an inverter.

■ Inverter operation comparison

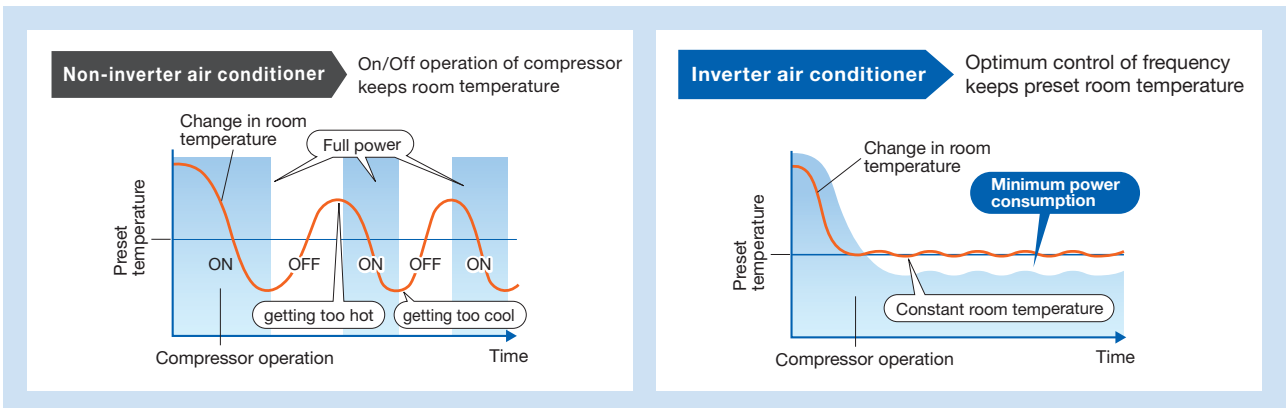

The compressors of air conditioners without an inverter start and stop repeatedly in order to maintain the preset room temperature. This repetitive on/off operation uses excessive electricity and compromises room comfort. The compressors of air conditioners equipped with an inverter run continuously; the inverter quickly optimizing the operating frequency according to changes in room temperature. This ensures energy-efficient operation and a more comfortable room.

Point 1 Quick & Powerful

Increasing the compressor motor speed by controlling the operation frequency ensures powerful output at start-up, brings the room temperature to the comfort zone faster than units not equipped with an inverter. Hot rooms are cooled, and cold rooms are heated faster and more efficiently.

Point 2 Room Temperature Maintained

The compressor motor operating frequency and the change of room temperature are monitored to calculate the most efficient waveform to maintain the room temperature in the comfort zone. This eliminates the large temperature swings common with non-inverter systems, and guarantees a pleasant, comfortable environment.

KEY TECHNOLOGIES

Our Rotary Compressor

Our rotary compressors use our original "Poki-Poki Motor" and "Heat Caulking Fixing Method" to realise downsizing and higher efficiency, and are designed to match various usage scenes in residential to commercial applications. Additionally, development of an innovative production method known as "Divisible Middle Plate" realises further size/weight reductions and increased capacity while also answering energy-efficiency needs.

Our Scroll Compressor

Our scroll compressors are equipped with an advanced frame compliance mechanism that allows self-adjustment of the position of the orbiting scroll according to pressure load and the accuracy of the fixed scroll position. This minimises gas leakage in the scroll compression chamber, maintains cooling capacity and reduces power loss.

MORE ADVANTAGES WITH MITSUBISHI ELECTRIC



Joint Lap DC Motor

Mitsubishi Electric has developed a unique motor, called the "Poki-Poki Motor" in Japan, which is manufactured using a joint lapping technique. This innovative motor operates based on a high-density, high-magnetic force, leading to extremely high efficiency and reliability.

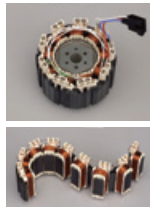

Magnetic Flux Vector Sine Wave Drive

This drive device is actually a microprocessor that converts the compressor motor's electrical current waveform from a conventional waveform to a sine wave (180° conduction) to achieve higher efficiency by raising the motor winding utilisation ratio and reducing energy loss.



Reluctance DC Rotary Compressor

Powerful neodymium magnets are used in the rotor of the reluctance DC motor. More efficient operation is realised by strong magnetic and reluctance torques produced by the magnets.

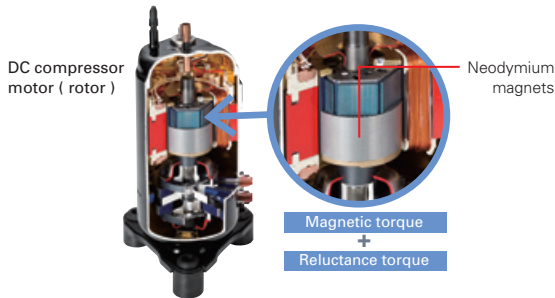

Highly Efficient DC Scroll Compressor

Higher efficiency has been achieved by adding a frame compliance mechanism to the DC scroll compressor. The mechanism allows movement in the axial direction of the frame supporting the cradle scroll, thereby greatly reducing leakage and friction loss, and ensuring extremely high efficiency at all speeds.

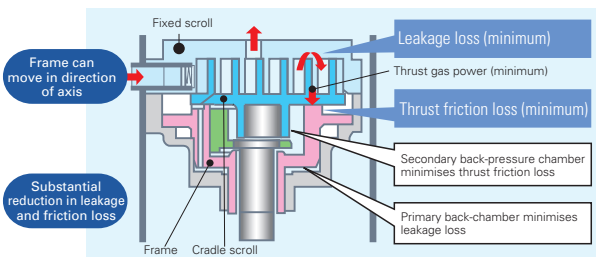

Heat Caulking Fixing Method

To fix internal parts in place, a "Heat Caulking Fixing Method" is used, replacing the former arc spot welding method. Distortion of internal parts is reduced, realising higher efficiency.

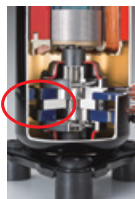

DC Fan Motor

A highly efficient DC motor drives the fan of the outdoor unit. Efficiency is much higher than an equivalent AC motor.



Vector-Wave Eco Inverter

This inverter monitors the varying compressor motor frequency and creates the most efficient waveform for the motor speed. As the result, operating efficiency in all speed ranges is improved, less power is used and annual electricity cost is reduced.

Smooth wave pattern

Inverter size has been reduced using insert-molding, where the circuit pattern is molded into the synthetic resin. To ensure quiet operation, soft PWM control is used to prevent the metallic whine associated with conventional inverters.

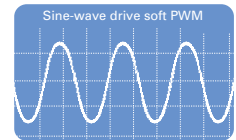

PAM (Pulse Amplitude Modulation)

PAM is a technology that controls the current waveform so that it resembles the supply voltage wave, thereby reducing loss and realising more efficient use of electricity. Using PAM control, 98% of the input power supply is used effectively.

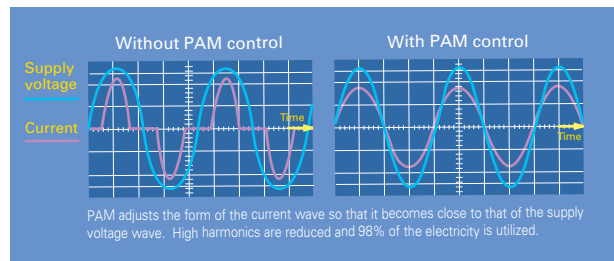

Merits of PAM Control

Significant energy savings
Remarkable reduction in power loss saves electricity

Limited energy savings
Electricity is wasted

Power increased
Efficient voltage increase realises increased power

Limited power
Insufficient power when needed



Power Receiver and Twin LEV Control

Mitsubishi Electric has developed a power receiver and twin linear expansion valves (LEVs) circuit that optimise compressor performance. This technology ensures optimum control in response to operating waveform and outdoor temperature. Operating efficiency has been enhanced by tailoring the system to the characteristics of R410A refrigerant.

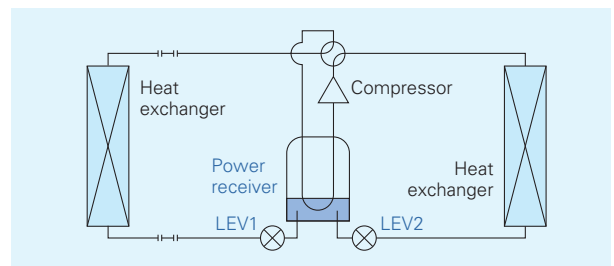

Grooved Piping

High-performance grooved piping is used in heat exchangers to increase the heat exchange area.

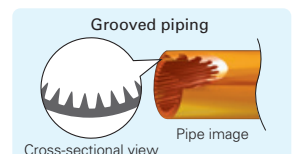

COMFORT

3D i-see Sensor

3D i-see Sensor for M SERIES

The LN Series and FH Series are equipped with the 3D i-see Sensor, an infrared-ray sensor that measures the temperature at distant positions. While moving to the left and right, eight vertically arranged sensor elements analyze the room temperature in three dimensions. This detailed analysis makes it possible to judge where people are in the room, thus allowing creation of features such as "Indirect airflow," to avoid airflow hitting people directly, and "direct airflow" to deliver airflow to where people are.

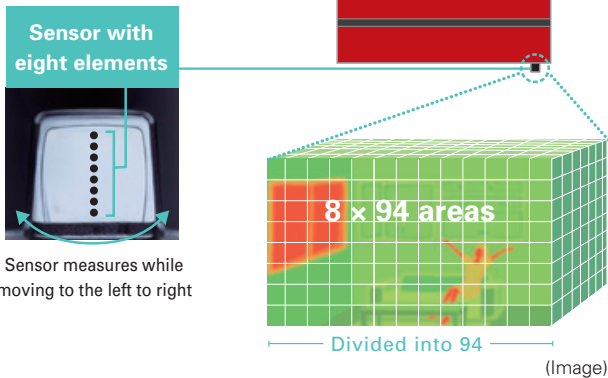

No occupancy energy-saving mode

The sensors detect whether there are people in the room. When no-one is in the room, the unit automatically switches to energy-saving mode.

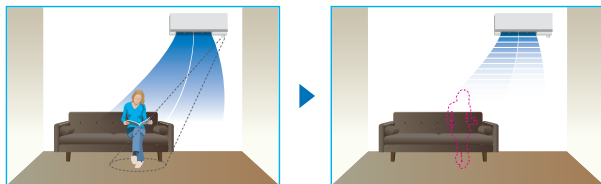

The "3D i-see Sensor" detects people's absence and the power consumption is automatically reduced approximately 10% after 10 minutes and 20% after 60 minutes.

Indirect Airflow

The indirect airflow setting can be used when the flow of air feels too strong or direct. For example, it can be used during cooling to avert airflow and prevent body temperature from becoming excessively cooled.

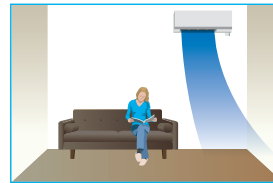

Direct Airflow

This setting can be used to directly target airflow at people such as for immediate comfort when coming indoors on a hot (cold) day.

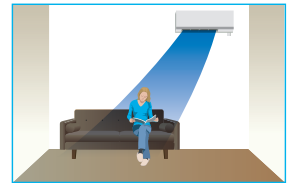

Even Airflow *LN Series only

Normal swing mode

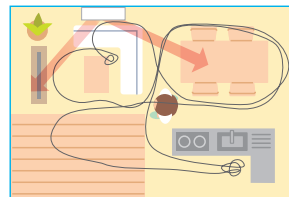

The airflow is distributed equally throughout the room, even to spaces where there is no human movement.

Even airflow mode

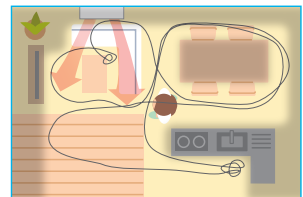

The 3D i-see sensor memorizes human movement and furniture positions, and efficiently distributes airflow.

No occupancy Auto-OFF mode *LN Series only

The sensors detect whether or not there are people in the room. When there is no one in the room, the unit turns off automatically.

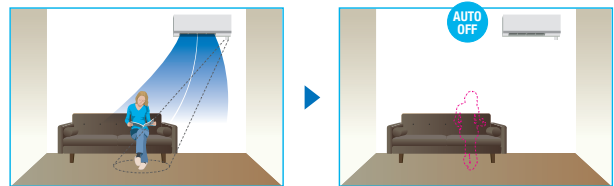

3D i-see Sensor for S & P SERIES

Detects number of people

The 3D i-see Sensor detects the number of people in the room and adjusts the power accordingly. This makes automatic power-saving operation possible in places where the number of people changes frequently. Additionally, when the area is continuously unoccupied, the system switches to a more enhanced power-saving mode. Depending on the setting, it can also stop the operation.

Detects people's position

Once a person is detected, the angle of the vane is automatically adjusted. Each vane can be independently set to "Direct Airflow" or "Indirect Airflow" according to taste.

Highly accurate people detection

A total of eight sensors rotate a full 360° in 3-minute intervals. In addition to detecting human body temperature, our original algorithm also detects people's positions and the number of people.



Detects number of people

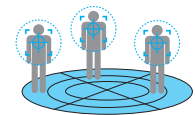

Detects people's position

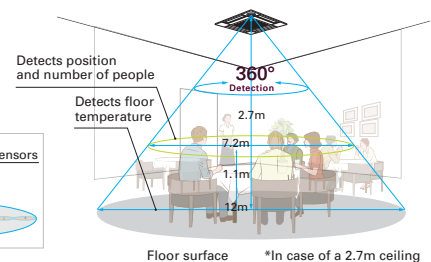
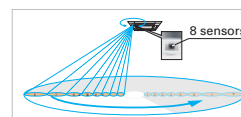
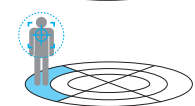

Detects number of people

Room occupancy energy-saving mode

The 3D i-see Sensor detects the number of people in the room. It then calculates the occupancy rate based on the maximum number of people in the room up to that point in time in order to save air-conditioning power. When the occupancy rate is approximately 30%, air-conditioning power equivalent to 1°C during both cooling and heating operation is saved. The temperature is controlled according to the number of people.

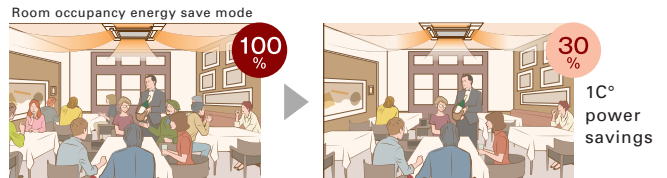

No occupancy energy-saving mode

When 3D i-see Sensor detects that no one is in the room, the system is switched to a pre-set power-saving mode. If the room remains unoccupied for more than 60min, air-conditioning power equivalent to 2°C during both cooling and heating operation is saved. This contributes to preventing waste in terms of heating and cooling.

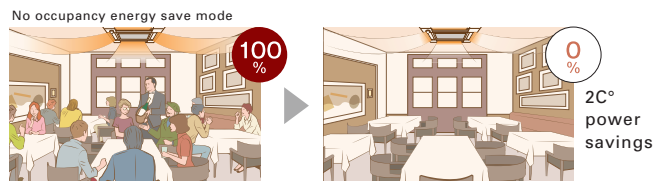

No occupancy Auto-OFF mode*

When the room remains unoccupied for a pre-set period of time, the air conditioner turns off automatically, thereby providing even greater power savings. The time until operation is stopped can be set in intervals of 10min, ranging from 60 to 180 min.

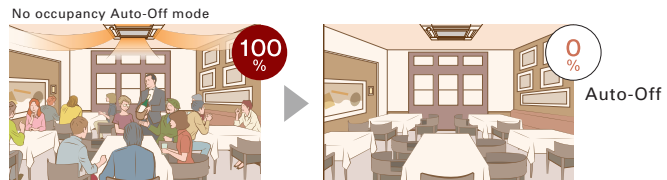

*PAR-40MAA is required for each setting

Detects people's position

Direct/Indirect settings*

The horizontal airflow spreads across the ceiling. When set to "Indirect Airflow" uncomfortable drafty-feeling is eliminated completely!

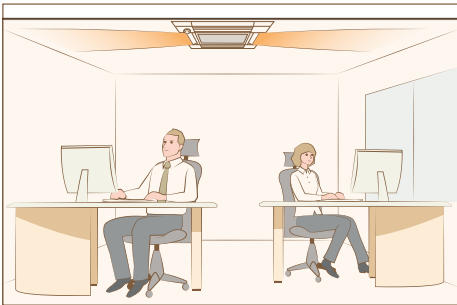

*PAR-40MAA or PAR-SL100A-E is required for each setting.

Seasonal airflow*

When cooling

Saves energy while keeping a comfortable effective temperature by automatically switching between ventilation and cooling. When a pre-set temperature is reached, the air conditioning unit switches to swing fan operation to maintain the effective temperature. This clever function contributes to keeping a comfortable coolness.

When heating

The air conditioning unit automatically switches between circulator and heating. Wasted heat that accumulates near the ceiling is reused via circulation. When a pre-set temperature is reached the air conditioner switches from heating to circulator and blows air in the horizontal direction. It pushes down the warm air that has gathered near the ceiling to people's height, thereby providing smart heating.

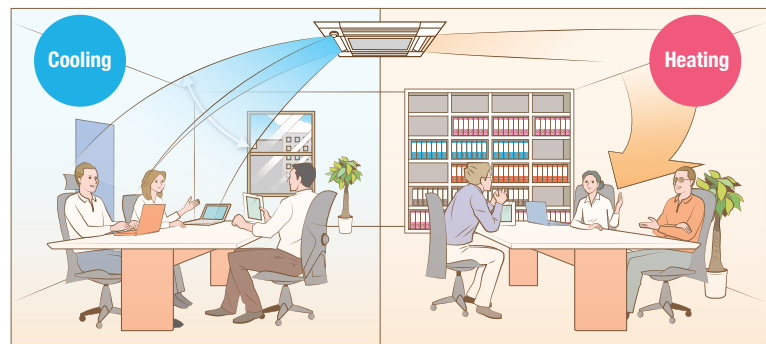

*PAR-40MAA is required for each setting.

AREA Area Temperature Monitor

The "3D i-see Sensor" monitors the whole room in sections and directs the airflow to areas of the room where the temperature does not match the temperature setting. (When cooling the room, if the middle of the room is detected to be hotter, more airflow is directed towards it.) This eliminates unnecessary heating /cooling and contributes to lower electricity costs.

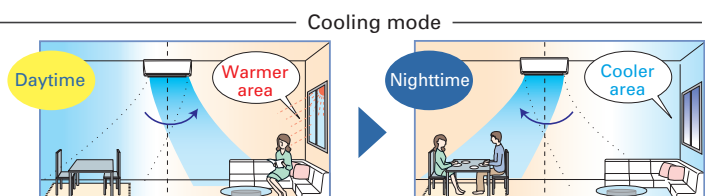

COMFORT

ENERGY-SAVING



Econo Cool Energy-Saving Feature

“Econo Cool” is an intelligent temperature control feature that adjusts the amount of air directed towards the body based on the air-outlet temperature. The setting temperature can be raised by as much as 2°C without any loss in comfort, thereby realising a 20% gain in energy efficiency. *(Function only available during manual cooling operation.)*

	Conventional	Econo Cool
Ambient temperature	35°C	35°C
Set temperature	25°C	27°C
Perceived temperature	30°C	29.3°C

Econo Cool Mode

A comfortable room environment is maintained even when setting the temperature 2°C higher than the conventional cooling mode.

Econo Cool on



Conventional cooling mode

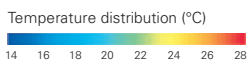

Demand Function (Onsite Adjustment)

The demand function can be activated when the unit is equipped with a commercially available timer or an On/Off switch is added to the CNDM connector (option) on the control board of the outdoor unit. Energy consumption can be reduced up to 100% of the normal consumption according to the signal input from outside.

[Example: Power Inverter Series]

Limit energy consumption by changing the settings of SW7-1, SW2 and SW3 on the control board of the outdoor unit. The following settings are possible.

SW7-1	SW2	SW3	Energy consumption
ON	OFF	OFF	100%
	ON	OFF	75%
	ON	ON	50%
	OFF	ON	0% (Stop)

*PUHZ outdoor only

AIR QUALITY



Plasma Quad Plus

Plasma Quad Plus is a plasma-based filter system similar to Plasma Quad, but in addition to bacteria, viruses, allergens, and dust, it can also filter out microparticles such as PM2.5.



Plasma Quad

Plasma Quad attacks bacteria and viruses from inside the unit using a strong curtain-like electrical field and discharge of electric current across the whole inlet-air opening of the unit.



Dual Barrier Coating

A two-barrier coating which prevents hydrophobic and hydrophilic dirt from sticking to the inner surface and inner parts of the indoor unit.



Fresh-air Intake

Indoor air quality is enhanced by the direct intake of fresh exterior air.



High-efficiency Filter

This high-performance filter has a much finer mesh compared to standard filters, and is capable of capturing minute particulates floating in the air that were not previously caught.



Air Purifying Filter

The filter has a large capture area and deodorise the circulating air.



Oil Mist Filter

The oil mist filter prevents oil mist from penetrating into the inner part of the air conditioner.



Long-life Filter

A special process for the entrapment surface improves the filtering effect, making the maintenance cycle longer than that of units equipped with conventional filters.



Filter Check Signal

Air conditioner operating time is monitored, and the user is notified when filter maintenance is necessary.



Silver-ionized Air Purifier Filter

Captures the bacteria, pollen and other allergens in the air and neutralises them.

AIR DISTRIBUTION



Double Vane

Double vane separates the airflow in the different directions to deliver airflow not only across a wide area of the room, but also simultaneously to two people in different locations.



Horizontal Vane

The air outlet vane swings up and down so that the airflow is spread evenly throughout the room.



Vertical Vane

The air outlet fin swings from side to side so that the airflow reaches every part of the room.



High Ceiling Mode

In the case of rooms with high ceilings, the outlet-air volume can be increased to ensure that air is circulated all the way to the floor.



Low Ceiling Mode

If the room has a low ceiling, the airflow volume can be reduced for less draft.



Auto Fan Speed Mode

The airflow speed mode adjusts the fan speed of the indoor unit automatically according to the present room conditions.

CONVENIENCE

CONVENIENCE

"i save" Mode

"i save" is a simplified setting function that recalls the preferred (preset) temperature by pressing a single button on the remote controller. Press the same button twice in repetition to immediately return to the previous temperature setting.

Using this function contributes to comfortable waste-free operation, realising the most suitable air conditioning settings and saving on power consumption when, for example, leaving the room or going to bed.

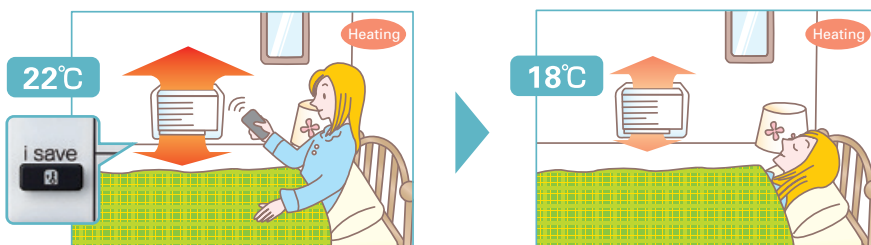

* Temperature can be preset to 10°C when heating in the "i-save" mode.



Auto Changeover

The air conditioner automatically switches between heating and cooling modes to maintain the desired temperature.

Low-temperature Cooling

Intelligent fan speed control in the outdoor unit ensures optimum performance even when the outside temperature is low.

Ampere Limit Adjustment

Dip switch settings can be used to adjust the maximum electrical current for operation. This function is highly recommended for managing energy costs.

*Maximum capacity is lowered with the use of this function.

Operation Lock (Indoor unit)

To accommodate specific-use applications, cooling or heating operation can be specified using the wireless remote controller. A convenient option when a system needs to be configured for exclusive cooling or heating service.

Operation Lock (Outdoor unit)

To accommodate specific-use applications, cooling or heating operation can be specified when setting the control board of the outdoor unit. A convenient option when a system needs to be configured for exclusive cooling or heating service.

Auto Restart

Especially useful at the time of power outages, the unit turns back on automatically when power is restored.

10°C Heating

During heating operation, the temperature can be set in 1°C increments down to 10°C.

■ Dip Switch Setting (Board for MXZ-5E102)

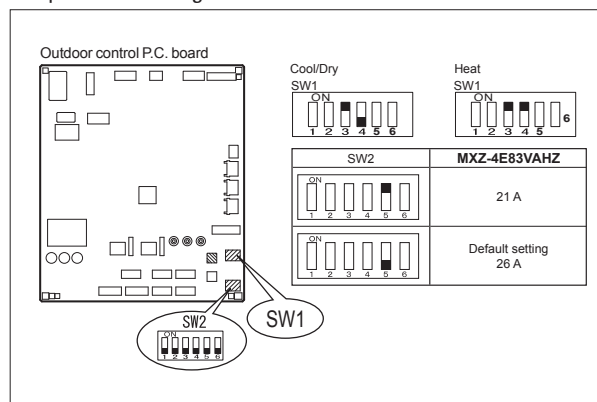

Night Mode

When Night Mode is activated using the wireless remote controller, it will switch to the settings described below.

- The brightness of the operation indicator lamp will become dimmer.
- The beeping sound will be disabled.
- The outdoor operating noise will drop to 3dB lower than the rated specification operating noise.

*The cooling/heating capacity may drop.

Low-noise Operation (Outdoor Unit)

System operation can be adjusted to prioritise less noise from the outdoor unit over air conditioning performance.

On/Off Operation Timer

Use the remote controller to set the times of turning the air conditioner On/Off.

Weekly Timer Function

Easily set desired temperatures and operation ON/OFF times to match lifestyle patterns. Reduce wasted energy consumption by using the timer to prevent forgetting to turn off the unit and eliminate temperature setting adjustments.

Example Operation Pattern (Winter/Heating mode)

	Mon.	Tues.	Wed.	Thurs.	Fri.	Sat.	Sun.
6:00	ON 20°C	ON 20°C	ON 20°C	ON 20°C	ON 20°C	ON 20°C	ON 20°C
8:00	Automatically changes to high-power operation at wake-up time						
10:00	OFF	OFF	OFF	OFF	OFF	ON 18°C	ON 18°C
12:00	Automatically turned off during work hours					Midday is warmer, so the temperature is set lower	
14:00							
16:00							
18:00	ON 22°C	ON 22°C	ON 22°C	ON 22°C	ON 22°C	ON 22°C	ON 22°C
20:00	Automatically turns on, synchronized with arrival at home					Automatically raises temperature setting to match time when outside-air temperature is low	
22:00							
(during sleeping hours)	ON 18°C	ON 18°C	ON 18°C	ON 18°C	ON 18°C	ON 18°C	ON 18°C
	Automatically lowers temperature at bedtime for energy-saving operation at night						

Settings

Pattern Settings: Input up to four settings for each day

Settings: • Start/Stop operation • Temperature setting *The operation mode cannot be set.

Easy set-up using dedicated buttons



The remote controller is equipped with buttons that are used exclusively for setting the Weekly Timer. Setting operation patterns is easy and quick.

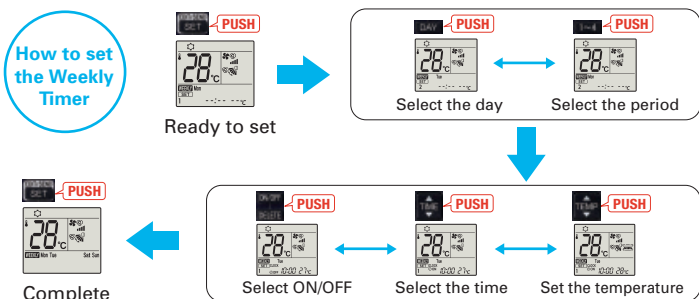

- Start by pushing the "SET" button and follow the instructions to set the desired patterns. Once all of the desired patterns are input, point the top end of the remote controller at the indoor unit and push the "SET" button one more time. (Push the "SET" button only after inputting all of the desired patterns into the remote controller memory. Pushing the "CANCEL" button will end the set-up process without sending the operation patterns to the indoor unit).
- It takes a few seconds to transmit the Weekly Timer operation unit patterns to the indoor unit. Please continue to point the remote controller at the indoor unit until all data has been sent.

INSTALLATION & MAINTENANCE

INSTALLATION



Cleaning-free Pipe Reuse

It is possible to reuse the same piping. It allows cleaning-free renewal of air conditioning systems that use R22 or R410 refrigerant.



Reuse of Existing Wiring

Wiring recycling problem solved! Compatible with other wiring connection methods*

The wiring method has been improved, making it possible to use methods different from that utilized for control and power supply. Units are compatible with the dual harness control line/power line method and the separate power supply method. Using a power supply terminal kit, wire can be efficiently reused at the time of system renewal regardless of the method the existing system uses.

* Optional. Usage may be limited due to wiring type diameter.

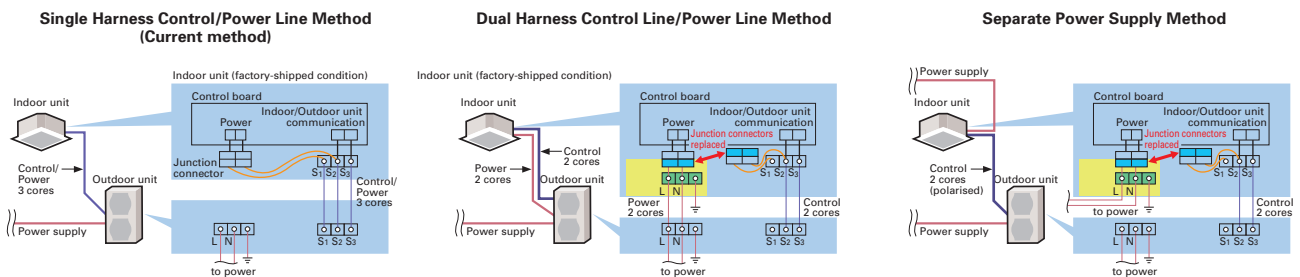

Wiring/Piping Correction Function*

The push of a single button is all that is required to confirm that piping and wiring are properly connected. Corrections are made automatically if a wiring error is detected, eliminating the need for complicated wiring confirmation work when expanding the number of rooms served.

* This function cannot be used when the outdoor temperature is below 0°C. The correction process requires 10–20 minutes, and only works when the unit is set to the Cooling mode.

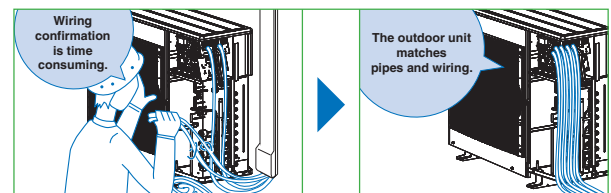

Drain Pump

A built-in drain pump enables drain piping to be raised.

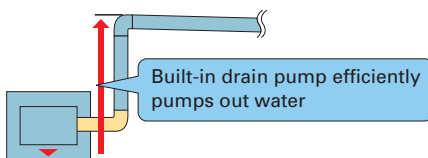

Flare Connection

Flare connection to cooling pipe work is possible.



Pump Down Switch

Enables smooth and easy recovery of refrigerant. Simply press the "Pump Down" switch before moving or changing the unit.

Outdoor unit control circuit board



* Photo of Model PUHZ-P100

Pump Down Switch



Pump down switch

Push this switch to start/stop refrigerant recovery operation automatically. (Valve in refrigerant circuit is opened/closed.)

MAINTENANCE



Self-Diagnostic Function (Check Code Display)

Check codes are displayed on the remote controller or the operation indicator to inform the user of malfunctions detected.



Failure Recall Function

Operation failures are recorded, allowing confirmation when needed.

SYSTEM CONTROL

SYSTEM CONTROL



PAR-40MAA/PAC-YT52CRA/PAC-CT01MAA

Units are compatible for use with the PAR-40MAA, PAC-YT52CRA or PAC-CT01MAA remote controller, which has a variety of management functions.



System Group Control

The same remote controller is capable of controlling the operational status of up to 16 refrigerant systems.



M-NET Connection

Units can be connected to MELANS system controllers (M-NET controllers) such as the AG-150A.



MELCloud (Wi-Fi interface)

MELCloud for fast, easy remote control and monitoring

MELCloud is a Cloud-based solution for controlling air-conditioner either locally or remotely by computer, tablet or smartphone via the Internet. Setting up and remotely operating via MELCloud is simple and straight forward. All you need is wireless computer connectivity in your home or the building where the air-conditioner is installed and an Internet connection on your mobile or fixed terminal. To set up the system, the router and the Wi-Fi interface must be paired, and this is done simply and quickly using the WPS button found on all mainstream routers.

You can control and check air-conditioner via MELCloud from virtually anywhere an Internet connection is available.

That means, thanks to MELCloud, you can use much more easily and conveniently.

Key control and monitoring features

- 1 Turn system on/off
- 2 See status of operating & adjust set point
- 3 Live weather feed from your location

Schedule timer - Set 7 day weekly schedule
Error status

- 4 Energy Consumption Monitoring

*MSZ-LN, AP Series are available



MELCloud uses the MAC-5671F-E interface

Connecting the Wi-Fi interface

The new Wi-Fi interface MAC-567IF-E can be mounted on the wall or on the outer side of the indoor unit. For LN Series, there is a built-in Wi-Fi interface inside the indoor unit.

When mounting on the wall

The interface can be mounted simply by affixing the holder to the wall on either side of the unit and inserting the interface unit into the holder.



*When mounting on the right side of the unit

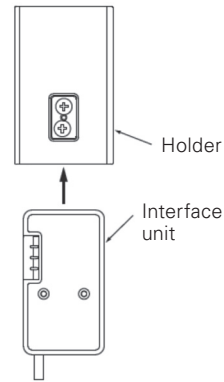

When mounting on the outer side of the unit

The interface can be mounted on the right side, left side, bottom right, or bottom left of the indoor unit. After inserting the clip into the holder, slip the clip over the edge of the corner box.

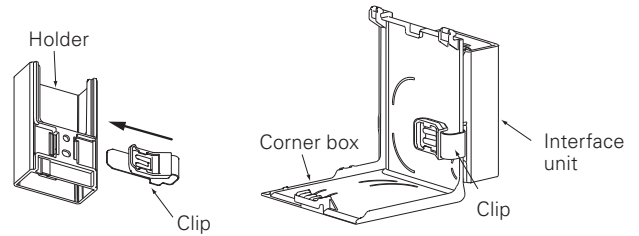

Right side



Bottom right



Left side



Bottom left

CONTROL TECHNOLOGIES

User-friendly Deluxe Remote Controller with Excellent Operability and Visibility



PAR-40MAA

Easy To Read & Easy To Use Inverted display screen

The screen background color can be set to black to suit the atmosphere of the installation location.



Full Dot Liquid-crystal Display Adopted

Easier to read thanks to use of a full dot liquid-crystal display with backlight, and easier to use owing to adopting a menu format that has reduced the number of operating buttons.

Display Example [Operation Mode]

Full Dot LCD



Multi-language Display

Multi-language

Control panel operation in fourteen different languages

Choose the desired language, among the following languages.

English	Spanish	Italian	Turkish
French	Greek	Portuguese	Swedish
German	Russian	Polish	Czech
Hangarian	Dutch		

Temperature Control

Dual Set Point

Two preset temperatures

When the operation mode is set to the Auto (Dual Set Point) mode, two preset temperatures (one each for cooling and heating) can be set. Depending on the room temperature, indoor unit will automatically operate in either the COOL or HEAT mode and keep the room temperature within the preset range.



Operation pattern during Auto (Dual Set Point) mode

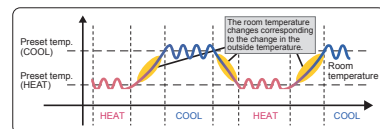

*Please refer to the function list on pages 188-190 for the combination of the available units.

Energy-efficient Control

Operation Control Functions

Energy-saving Schedule

Precise control of power consumption

The amount of power consumed in each time period is managed so that the demand value is not exceeded. The demand control function can be set to start and finish in 5-minute units. Additionally, the level can be adjusted to 0, 50, 60, 70, 80 or 90% of maximum capacity, and up to 4 patterns can be set per day. Air-conditioning operation is automatically controlled to ensure that electricity in excess of the contracted volume is not consumed.

Setting pattern example

Start time	Finish time	Capacity savings
8:15 →	12:00	80%
12:00 →	13:00	50%
13:00 →	17:00	90%
17:00 →	21:00	50%

Auto-return

Prevents wasteful operation by automatically returning to the preset temperature after specified operating time

After adjusting the temperature for initial heating in winter or cooling on a hot summer day, it is easy to forget to return the temperature setting to its original value. The Auto-return function automatically resets the temperature back to the original setting after a specified period of time, thereby preventing overheating/overcooling. The Auto-return activation time can be set in 10-minute units, in a range between 30 and 120 minutes.

*Auto-return cannot be used when Temperature Range Restrictions is in use.

Auto-off Timer

Turns heating/cooling off automatically after preset time elapses

When using Auto-off Timer, even if one forgets to turn off the unit, operation stops automatically after the preset time elapses, thereby preventing wasteful operation. Auto-off Timer can be set in 10-minute units, in a range between 30 minutes and 4 hours. Eliminates all anxiety about forgetting to turn off the unit.

Recommended for Meeting room Changing room

Night Setback

Keep desired room temperatures automatically

This function monitors the room temperature and automatically activates the heating mode when the temperature drops below the preset minimal temperature setting. It has the same function for cooling, automatically activating the cooling mode when the temperature rises above the preset maximum temperature setting.

Operation Lock

Fixed temperature setting promotes energy savings

In addition to operation start/stop, the operation mode, temperature setting and airflow direction can be locked. Unwanted adjustment of temperature settings is prevented and an appropriate temperature is constantly maintained, leading to energy savings. This feature is also useful in preventing erroneous operation or tampering.

Recommended for Office School Public hall
Hospital Computer server facility

Temperature Range Restriction

Temperature Range Restriction prevents overheating/overcooling

Using a temperature that is 1°C lower/higher for heating/cooling results in a 10% reduction in power consumption.* Temperature Range Restriction limits the maximum and minimum temperature settings, contributing to the prevention of overheating/overcooling.

*In-house calculations

Cooling/Dry

(Setting example of minimum temp. in 25°C)

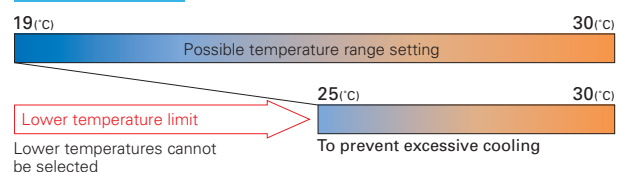

Recommended for Office Restaurant

Weekly Timer

Weekly Timer with Two Types of Settings

Weekly schedule timer can save two different settings which can be easily switched according to different seasons.

In addition, it offers eight different pattern setting per day. (on, off and temperature setting)

*Weekly Timer cannot be used when On/Off Timer is in use.

Setting Example (restaurant in summer time)

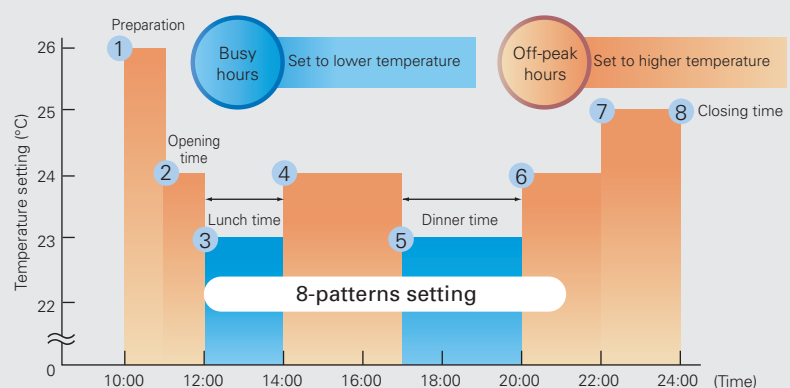

Necessary to change temperature settings for cooling/heating times.

*Joint research conducted with Japan Facility Solutions, Inc.

CONTROL TECHNOLOGIES

Installation/Maintenance Support Functions

Smooth Maintenance

Outdoor unit data accessed immediately, enabling fast maintenance (only PUZ/PUHZ type)

Using the Stable Operation Control (fixed frequency) of the Smooth Maintenance function, the operating status of the inverter can be checked easily via the screen on the remote controller.

Smooth Maintenance Function Operating Procedure

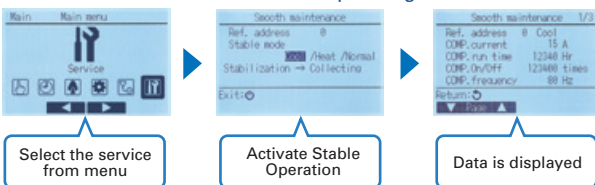

Display information (11 items)

Compressor		⑥	OU TH4 temp. (°C)
①	COMP. current (A)	⑦	OU TH6 temp. (°C)
②	COMP. run time (Hr)	⑧	OU TH7 temp. (°C)
③	COMP. ON/OFF (times)	Indoor Unit	
④	COMP. frequency (Hz)	⑨	IU air temp. (°C)
Outdoor Unit		⑩	IU HEX temp. (°C)
⑤	Sub cool (°C)	⑪	IU filter operating time* (Hr)

*IU filter operating time is the time elapsed since filter was reset.

Inspection Guidelines

The computed temperature difference is plotted as in the graph below and operating status is determined.

		Item
Cooling	Temp. difference	(⑥ OU TH4 temp.) - (⑦ OU TH6 temp.)
		(⑨ IU air temp.) - (⑩ IU HEX temp.)
Heating	Temp. difference	(⑥ OU TH4 temp.) - (⑩ IU HEX temp.)
		(⑩ IU HEX temp.) - (⑨ IU air temp.)

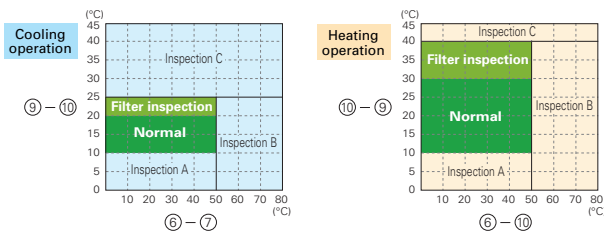

Normal	Normal operating status.
Filter inspection	Filter may be blocked.*1
Inspection A	Capacity is reduced. Detailed inspection is necessary.
Inspection B	Refrigerant level is low.
Inspection C	Filter or indoor unit heat exchanger is blocked.

*1: Due to indoor and outdoor temperatures, "Filter inspection" may be displayed even if the filter is not blocked.

* The above graphs are based on trial data. Results may vary depending on installation/temperature conditions.

- Stable operation may not be possible under the following temperature conditions:
 - In cooling mode when the outdoor induction temperature is over 40°C or the indoor induction temperature is below 23°C.
 - In heating mode when the outdoor induction temperature is over 20°C or when the indoor induction temperature is over 25°C.
- If the above temperature conditions do not apply and stable operation is not achieved after 30 minutes has passed, please inspect the units.
- The operating status may change due to frost on the outdoor heat exchanger.

Manual Vane Angle Setting (4-way ceiling cassette)

Direction of vertical airflow for each vane can be set

Setting the vertical airflow direction for each individual vane can be performed simply via illustrated display. Seasonal settings such as switching between cooling and heating are easily changed as well.

Auto-descending Panel Operation

Easily raise/lower panels using the remote controller

Auto-descending panel operation is available as an option. Panels can be raise/lower using a button on the wired remote controller. Filter cleaning can be performed easily.

Silent Mode

Three outdoor noise level setting

The outdoor noise level can be reduced on demand according to the surrounding environment. Select from three setting mode: standard mode (rated), silent mode and ultra-silent mode.

Initial Password Setting

Password for initial settings

A password is required (default setting is "0000") for initial settings such as time and display language.

Rotation
Back-up

Rotation*, Back-up* and 2nd Stage Cut-in Functions* (PAR-40MAA)

(1) Rotation and Back-up Functions

Function Outline

- Main and sub units take turns operating according to a rotation interval setting.
- If one unit malfunctions, the other unit automatically begins operation (Back-up function)

*PUZ/PUHZ only

System Image

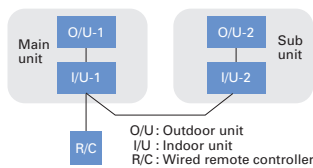

(2) 2nd Stage Cut-in Function

Function Outline

- Number of units operating is based on room temperature and predetermined settings.
- When room temperature rises above the desired setting, the standby unit starts (2-unit operation).
- When the room temperature falls 4°C below the predetermined setting, the standby unit stops (1-unit operation).

System Constraint

- This function is only available for rotation operation and when the back-up function is in cooling mode.

*PUZ/PUHZ only

Operation Pattern

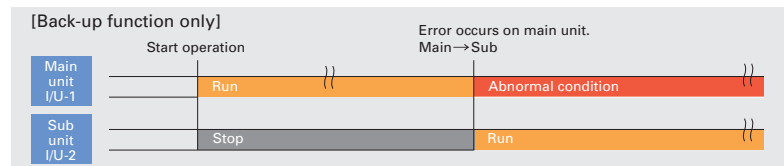

[Rotation function] & [Back-up function]

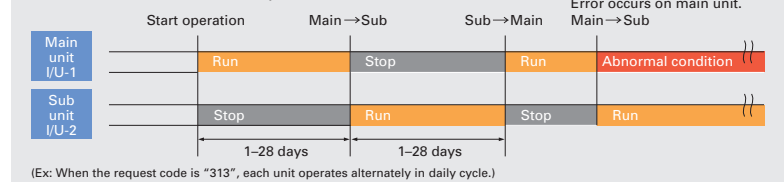

Operation Pattern

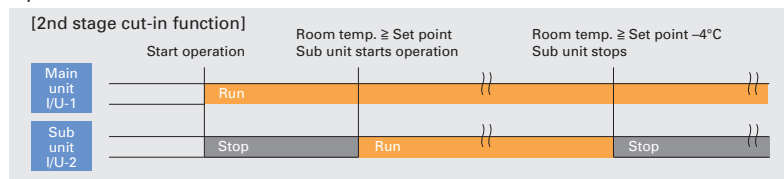

Simple MA Remote Controller PAC-YT52CRA

Backlit LCD

Features a liquid-crystal display (LCD) with backlight for operation in dark conditions.

Flat Back

The slim and flat-back shape makes installation easier without requiring a hole in the wall. Thickness is 14.5mm or less.

Vane Angle Setting

The vane button has been added to allow users to change the airflow direction (ceiling-cassette and wall-mounted units).

Pressing the button will switch the vane direction.

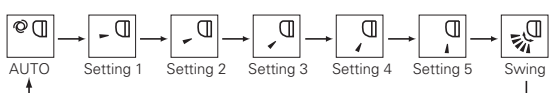

* The settable vane directions vary depending on the indoor unit model to be connected.

* If the unit has no vane function, the vane direction cannot be set. In this case, the vane icon flashes when the button is pressed.

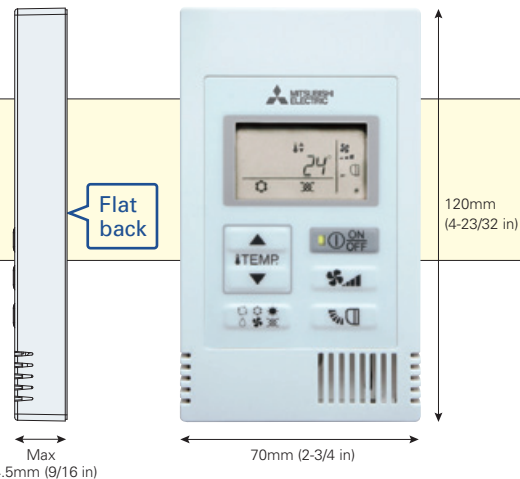

Dual Set Point

Two preset temperatures

When the operation mode is set to the Auto (Dual Set Point) mode, two preset temperatures (one each for cooling and heating) can be set. Depending on the room temperature, indoor unit will automatically operate in either the COOL or HEAT mode and keep the room temperature within the preset range.

Operation pattern during Auto (Dual Set Point) mode

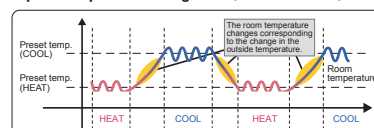

*Please refer to the function list on pages 188-190 for the combination of the available units.

CONTROL TECHNOLOGIES

MAT Touch Remote Controller
PAC-CT01MAA-SB
PAR-CT01MAA-PB



PAC-CT01MAA-SB

PAR-CT01MAA-PB

User-friendly Visible big size icons on the full color touch panel display.

Full color touch panel display



Touch Panel

3.5 inch/HVGA Full Color LCD



Operation panels

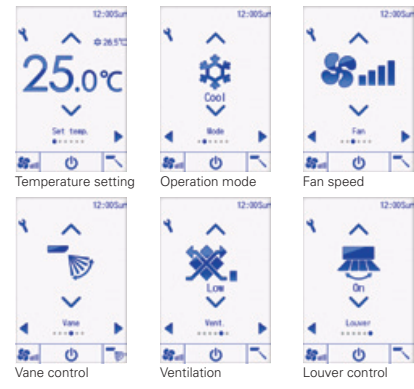

Flexibility Customized display, color on parameter and background, editable parameter, logo image on the initial display.

Multiple color pattern

180 color patterns can be selected for control parameters or background on the display.

Control parameter customize

Users can customize the panel to display the selected parameters only.

- Control parameter customize
 Simple operation panel is liked by users, especially in hotels. It is available to display only ON/OFF, set temp., fan speed.



Logo image customization

Logo image can be displayed on the initial screen.

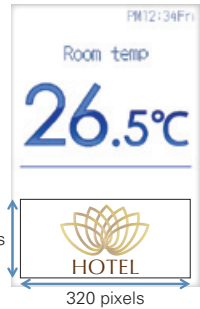

Available in a wide variety of colors to suit the decor of any room.



Expandability Smartphone / tablet App is available for setting, customize, and control.

Bluetooth® low energy technology

Remote controller can communicate with smartphone or tablet device via Bluetooth Low Energy (BLE). Operation & Setting App are available on the App store.



*The Bluetooth® word mark is trademark of Bluetooth SIG, Inc., USA.
*Contact the sales company for information on "Bluetooth" function.

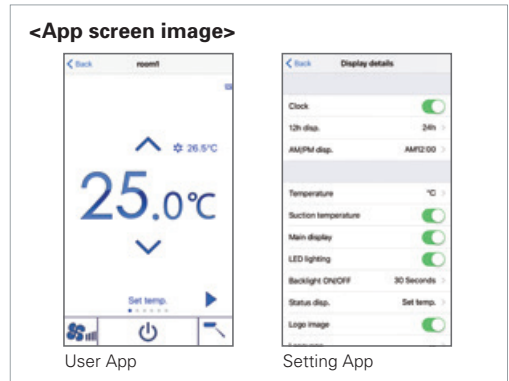

Convenient BLE transmission functions for installation contractors

Initial setup for the remote controller can be easily performed using BLE transmission via a smartphone.

● **Previous model**

Previously, initial setup (selecting function parameters) was only available via the remote controller installed each room.

● **New model**

The initial setup (selecting function parameters) can now be performed in advance on a smartphone, with the settings transmitted to the remote controller by enabling BLE transmission upon entry to the room.

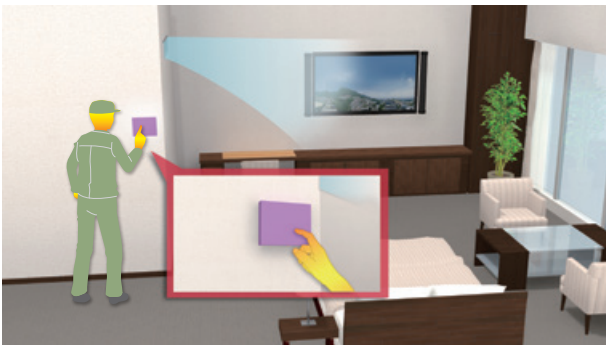

Convenient BLE transmission functions for guests

The remote controller has been further upgraded with hotels in mind, to allow smartphone connectivity and multilingual support.

Smartphone connectivity

For example, hotel guests can operate the air conditioner via their smartphones, without getting out of bed.

Multilingual support

The smartphone app can be displayed in the language that the guest's smartphone is set to.



CONTROL TECHNOLOGIES

Wireless Remote Controller PAR-SL100A-E

Weekly Timer

The Weekly Timer enables the setting of operation start and finish times and adjusting the temperature as standard features. Up to 4 patterns per day can be set, providing operation that matches the varying conditions of each period, such as the number of customers in the store.

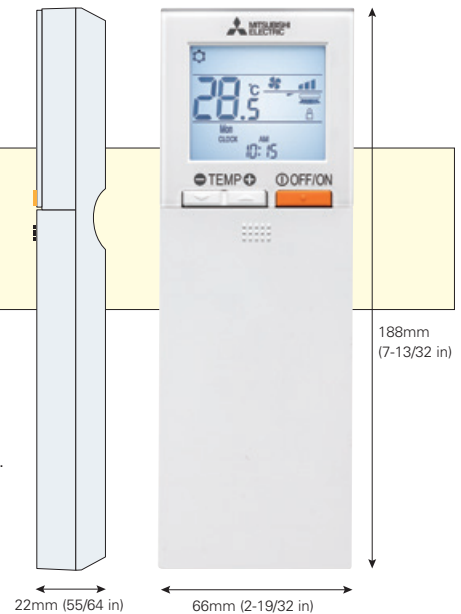
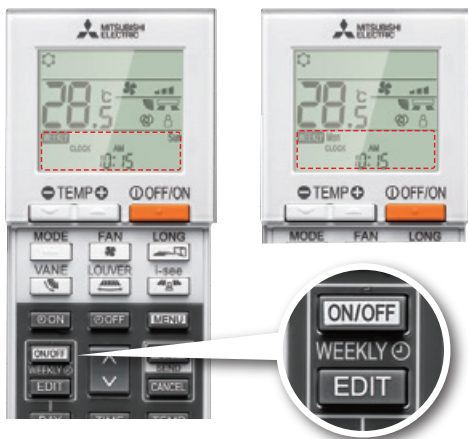

Example Operation Pattern (Winter/Heating mode)

	Mon.	Tues.	Wed.	Thurs.	Fri.	Sat.	Sun.
6:00	ON 20°C	ON 20°C	ON 20°C	ON 20°C	ON 20°C	ON 20°C	ON 20°C
8:00	Automatically changes to high-power operation at wake-up time						
10:00	OFF	OFF	OFF	OFF	OFF	ON 18°C	ON 18°C
12:00	Automatically turned off during work hours						
14:00	Midday is warmer, so the temperature is set lower						
16:00	Automatically turns on, synchronized with arrival at home						
18:00	ON 20°C	ON 20°C	ON 20°C	ON 20°C	ON 20°C	ON 20°C	ON 20°C
20:00	Automatically raises temperature setting to match time when outside-air temperature is low						
22:00 (during sleeping hours)	ON 18°C	ON 18°C	ON 18°C	ON 18°C	ON 18°C	ON 18°C	ON 18°C
	Automatically lowers temperature at bedtime for energy-saving operation at night						

*Weekly Timer cannot be used when On/Off Timer is in use.
*Only for SLZ-KF25/35/50/60VA2, PLA-ZP/RP35/50/60/71/100/125/140EA

Backlight

Backlight function incorporated, making screen easy to read in the dark. Even in dimly lit rooms, the screen can be seen clearly for trouble-free remote controller operation.

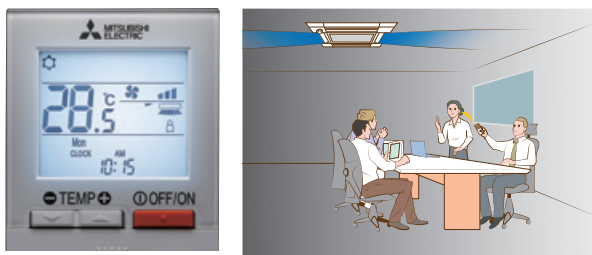

Individual Vane Settings

The airflow directions of the four vanes can each be adjusted independently. Easily set the optimum airflow according to the room setting.

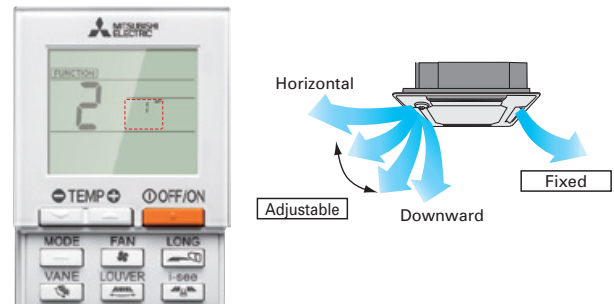

Dual Set Point

When the operation mode is set to the Auto (Dual Set Point) mode, two preset temperatures (one each for cooling and heating) can be set. Depending on the room temperature, the indoor unit will automatically operate in either the COOL or HEAT mode and keep the room temperature within the preset range.

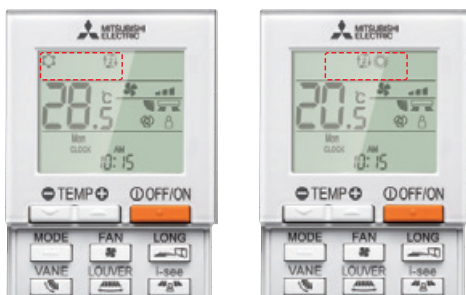

Operation pattern during Auto (Dual Set Point) mode

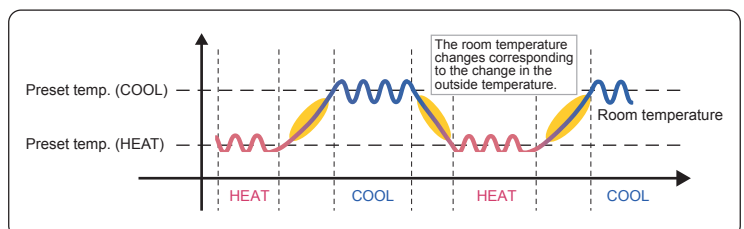

* Only available for compatible models.

Battery Replacement Sign



Previous wireless remote controllers were not easy to read, understand or use sometimes because the battery was low. Beginning with the PAR-SL100A-E, a battery charge indicator that shows the charge status is included in the LCD so it can be seen when the battery is low and needs to be changed.

3D i-see Sensor (Direct/Indirect Airflow)

Pressing the i-see button enables direct or indirect setting of all vanes.

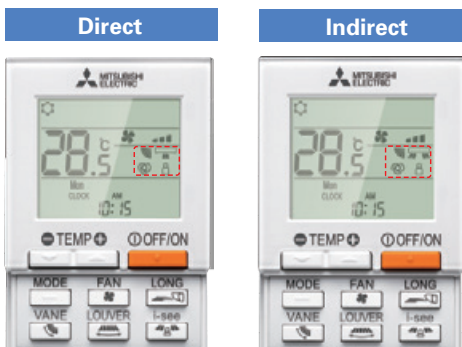

	Vane setting	
	Direct	Indirect
Cooling	horizontal → swing	keep horizontal
Heating	keep downward	downward → horizontal

Direct Airflow



Indirect Airflow

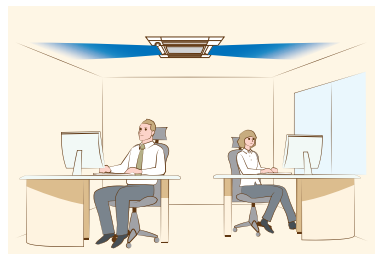

*Only available for models equipped with 3D i-see Sensor.

Basic Functions

Functions	Button	Liquid crystal
OFF / ON	OFF/ON 	
Preset temperature	TEMP 	
Mode	MODE 	Cool Dry Heat Fan Auto Dual set point *Dual Set Point function not operational first use.
Fan speed	FAN 	4-Speed Auto
Vane angle	VANE 	5-step Swing Auto
3D i-see Sensor	i-see 	Direct Indirect
Send sign		
Battery replacement sign		
Function setting		
Test run		
Self check		
Not available		





*This remote controller is only compatible with the following models: SLZ-M15/25/35/50/60FA, PLFY-P15/20/25/32/40/50VFM-E1, PLA-ZM/RP35/50/60/71/100/125/140EA, PLFY-P20/25/32/40/50/63/80/100/125VEM-E

*Functions available vary according to the model.

SYSTEM CONTROL

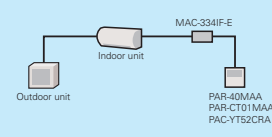
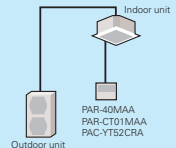
Versatile system controls can be realised using optional parts, relay circuits, control panels, etc.

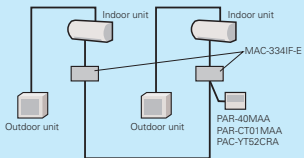
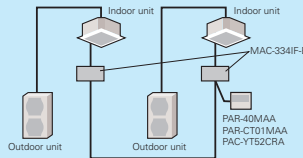
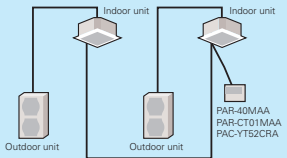
MAJOR SYSTEM CONTROL

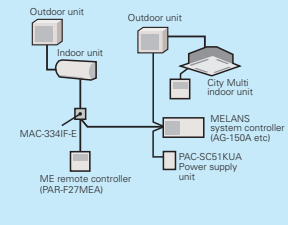
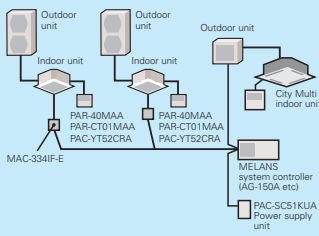
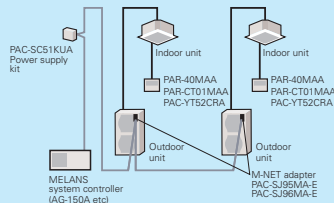
System Examples			
Indoor Unit	M Series Indoor Unit	S Series & P Series Indoor Unit	P Series Indoor Unit
Outdoor Unit	M Series and MXZ Series Outdoor	S Series and MXZ Series Outdoor	P Series Outdoor
 <p>PAR-40MAA Control PAC-YT52CRA Control</p>			
Details	<ul style="list-style-type: none"> Wired remote controller can be connected to indoor unit 	Standard equipment (for indoor units compatible with wired remote controllers)	
Major Optional Parts Required	<ul style="list-style-type: none"> MAC-334IF-E (Interface) PAR-40MAA (Wired remote controller) PAR-CT01MAA (Wired remote controller) PAC-YT52CRA (Wired remote controller) 	<ul style="list-style-type: none"> PAR-40MAA (Wired remote controller) PAR-CT01MAA (Wired remote controller) PAC-YT52CRA (Wired remote controller) 	
 <p>System Group Control</p>			
Details	<ul style="list-style-type: none"> One remote controller can control plural air conditioners with the same settings simultaneously. One remote controller can control up to 16 refrigerant systems. (When connected to a MXZ unit, MAC-334IF-E is counted as one system.) Up to two remote controller can be connected. PAR-SL100A cannot be used when connected through the MAC-334IF-E or when group control is used. 		
Major Optional Parts Required	<ul style="list-style-type: none"> MAC-334IF-E (Interface) PAR-40MAA (Wired remote controller) PAR-CT01MAA (Wired remote controller) PAC-YT52CRA (Wired remote controller) 		<ul style="list-style-type: none"> PAR-40MAA (Wired remote controller) PAR-CT01MAA (Wired remote controller) PAC-YT52CRA (Wired remote controller)
 <p>M-NET Connections</p>			
Details	<ul style="list-style-type: none"> Group of air conditioners can be controlled by MELANS system controller (M-NET). 		
Major Optional Parts Required	<ul style="list-style-type: none"> MAC-334IF-E (M-NET Interface) MELANS System controller PAC-SC51KUA (power supply unit) 		<ul style="list-style-type: none"> PAC-SJ95MA-E or PAC-SJ96MA-E (M-NET converter) MELANS System controller PAC-SC51KUA (power supply unit)

OTHERS

For M Series Indoor Units (New A-control Models Only)

	System Examples	Connection Details	Control Details	Major Optional Parts Required
1 Remote On/Off Operation • Air conditioner can be started/stopped remotely. (1) and (2) can be used in combination		Connect the interface to the air conditioner. Then connect the locally purchased remote controller to the terminal in the interface.	On/Off operation is possible from a remote location.	<ul style="list-style-type: none"> MAC-334IF-E (Interface) Parts for circuit such as relay box, lead wire, etc. (to be purchased locally)
2 Remote Display of Operation Status • The On/Off status of air conditioners can be confirmed remotely. (1) and (2) can be used in combination		Connect the interface to the air conditioner. Then connect the locally purchased remote controller to the terminal in the interface.	The operation status (On/Off) or error signals can be monitored from a remote location.	<ul style="list-style-type: none"> MAC-334IF-E (Interface) Parts for circuit to be purchased locally (DC power source needed) External power source (12V DC) is required when using MAC-334IF-E.

For P Series and S Series Indoor Units

	System Examples		Details	Major Optional Parts Required
	Wired remote controller	Wireless remote controller		
A 2-remote Controller Control With two remote controllers, control can be performed locally and remotely from two locations.	<p style="font-size: small;">* Set "Main" and "Sub" remote controllers.</p> <p style="font-size: x-small;">(Example of 1 : 1 system)</p>	<p style="font-size: x-small;">* When using wired and wireless remote controllers</p> <p style="font-size: x-small;">(Example of Simultaneous Twin)</p>	<ul style="list-style-type: none"> Up to two remote controllers can be connected to one group. Both wired and wireless remote controllers can be used in combination. 	<ul style="list-style-type: none"> Wired Remote Controller PAR-40MAA PAC-YT52CRA (for PKA, PAC-SH29TC-E is required) Wireless Remote Controller PAR-SL97A-E/PAR-SL100A-E (only for SLZ) Wireless Remote Controller Kit for PCA PAR-SL94B-E
B Operation Control by Level Signal Air conditioner can be started/stopped remotely. In addition, On/Off operation by local remote controller can be prohibited/permitted.	<p style="font-size: x-small;">(Example of 1 : 1 system x 2)</p>	<p style="font-size: x-small;">(Example of 1 : 1 system x 2)</p>	<ul style="list-style-type: none"> Operation other than On/Off (e.g., adjustment of temperature, fan speed, and airflow) can be performed even when remote controller operation is prohibited. Timer control is possible with an external timer. 	<ul style="list-style-type: none"> Adapter for remote On/Off PAC-SE55RA-E Relay box (to be purchased locally) Remote control panel (to be purchased locally)
C Operation Control by Pulse Signal	<p style="font-size: x-small;">(Example of 1 : 1 system x 2)</p>	<p style="font-size: x-small;">(Example of 1 : 1 system x 2)</p>	<ul style="list-style-type: none"> The pulse signal can be turned On/Off. Operation/emergency signal can be received at a remote location. 	<ul style="list-style-type: none"> Connector cable for remote display PAC-SA88HA-E/PAC-725AD (10 pcs. x PAC-SA88HA-E) Relay box (to be purchased locally) Remote control panel (to be purchased locally)
D Remote Display of Operating Status Operating status can be displayed at a remote location.	<p style="font-size: x-small;">(Example of 1 : 1 system)</p>	<p style="font-size: x-small;">(Example of Simultaneous Twin)</p>	<ul style="list-style-type: none"> Operation/emergency signal can be received at a remote location (when channeled through the PAC-SF40RM-E → no-voltage signal, when channeled through the PAC-SA88HA-E → DC 12V signal). 	<ul style="list-style-type: none"> Remote display panel (to be purchased locally) Connector cable for remote display PAC-SA88HA-E/PAC-725AD (10 pcs. x PAC-SA88HA-E) Relay box (to be purchased locally) Remote operation adapter PAC-SF40RM-E <p style="font-size: x-small;">* Unable to use with wireless remote controller</p>
E Timer Operation Allows On/Off operation with timer *For control by an external timer, refer to (B) Operation Control by Level Signal.	<p style="font-size: x-small;">(Example of 1 : 1 system)</p>		<ul style="list-style-type: none"> Weekly Timer: On/Off and up to 8 pattern temperatures can be set for each calendar day. (Initial setting) On/Off Timer: On/Off can be set once each within 72 hr in intervals of 5-minute units. Auto-off Timer: Operation will be switched off after a certain time elapse. Set time can be changed from 30 min. to 4 hr. at 10 min. intervals. <p style="font-size: x-small;">*Simple Timer and Auto-off Timer cannot be used at the same time.</p>	Standard functions of PAR-40MAA / PAR-CT01MAA

FUNCTION LIST (1)

Category	Icon	M SERIES																									
		Combination	Indoor unit	MSZ-LN18/25/35/50/60VG(W)(V)(R)(B)						MSZ-AP15/20VF						MSZ-AP25/35/42/50VG						MSZ-FH25/35/50VE2					
				Outdoor unit	MUZ -LN	MXZ -2D/F	MXZ -3E/F	MXZ -4E/F	MXZ -5E	MXZ -6D	MXZ -2D/F	MXZ -3E/F	MXZ -4E/F	MXZ -5E	MXZ -6D	MUZ -AP	MXZ -2D/F	MXZ -3E/F	MXZ -4E/F	MXZ -5E	MXZ -6D	MUZ -FH	MXZ -2D	MXZ -3E	MXZ -4E	MXZ -5E	MXZ -6D
Technology	DC Inverter		●	●	●	●	●	●	●	●	●	●	●	●	●	●	●	●	●	●	●	●	●	●	●		
	Joint Lap DC Motor		●	●	●	72/83VA	●	●	●	●	72/83VA	●	●	●	●	72/83VA	●	●	●	●	72/83VA	●	●	●	●		
	Reluctance DC Rotary Compressor				83	●	●			83	●	●			83	●	●			83	●	●					
	Heating Caulking (Compressor)		●	●	●	72/83VA	●	●	●	●	72/83VA	●	●	●	●	72/83VA	●	●	●	●	72/83VA	●	●	●	●		
	DC Fan Motor		●	●	●	●	●	●	●	●	●	●	●	●	●	●	●	●	●	●	●	●	●	●	●		
	PAM (Pulse Amplitude Modulation)		●	●	●	●	●	●	●	●	●	●	●	●	●	●	●	●	●	●	●	●	●	●	●		
	Power Receiver and Twin LEV Control				●	72				●	72				●	72				●	72						
	Grooved Piping		●	●	●	●	●	●	●	●	●	●	●	●	●	●	●	●	●	●	●	●	●	●	●		
i-see Sensor	Felt Temperature Control (3D i-see Sensor)		●	●	●	●	●	●												●	●	●	●	●			
	AREA Temperature Monitor		●	●	●	●	●	●												●	●	●	●	●			
Energy Saving	Econo Cool Energy-saving Feature		●	●	●	●	●	●	●	●	●	●	●	●	●	●	●	●	●	●	●	●	●	●			
	Standby Power Consumption Cut		●												●					●							
Air Quality	Plasma Quad Plus		●	●	●	●	●	●																			
	Plasma Quad																			●	●	●	●	●			
	Dual Barrier Coating		●	●	●	●	●	●																			
	Silver-ionized Air Purifier Filter		Opt	Opt	Opt	Opt	Opt	Opt							Opt	Opt	Opt	Opt	Opt	Opt	●	●	●	●			
	Air Purifying Filter														●	●	●	●	●	●							
Air Distribution	Double Vane		●	●	●	●	●	●												●	●	●	●	●			
	Horizontal Vane		●	●	●	●	●	●	●	●	●	●	●	●	●	●	●	●	●	●	●	●	●	●			
	Vertical Vane		●	●	●	●	●	●							●	●	●	●	●	●	●	●	●	●			
	High Ceiling Mode																										
	Auto Fan Speed Mode		●	●	●	●	●	●	●	●	●	●	●	●	●	●	●	●	●	●	●	●	●	●			
Convenience	On/off Operation Timer		●	●	●	●	●	●	●	●	●	●	●	●	●	●	●	●	●	●	●	●	●	●			
	"i save" Mode		●	●	●	●	●	●	●	●	●	●	●	●	●	●	●	●	●	●	●	●	●	●			
	Auto Changeover		●	●*1	●*1	●*1	●*1	●*1	●*1	●*1	●*1	●*1	●*1	●*1	●	●*1	●*1	●*1	●*1	●*1	●	●*1	●*1	●*1	●*1		
	Auto Restart		●	●	●	●	●	●	●	●	●	●	●	●	●	●	●	●	●	●	●	●	●	●	●		
	Low-temperature Cooling		●	●	●	●	●	●	●	●	●	●	●	●	●	●	●	●	●	●	●	●	●	●	●		
	10°C Heating		●	●	●	●	●	●																			
	Low-noise Operation (Outdoor Unit)			●	●	●	●	●	●	●	●	●	●	●						●	●	●	●	●			
	Night Mode		●	●*4	●*4	●*4	●*4	●*4																			
	Ampere Limit Adjustment			2E		83	●	●	2E		83	●	●		2E		83	●	●		2E		83	●	●		
	Operation Lock (Indoor)		●	●	●	●	●	●							●	●	●	●	●	●							
	Operation Lock (Outdoor)			●	●	●	●	●	●	●	●	●	●	●		●	●	●	●	●	●	●	●	●	●		
	Built-in Weekly Timer Function		●	●	●	●	●	●	●	●	●	●	●	●	●	●	●	●	●	●	●	●	●	●	●		
System Control	PAR-40MAA Control *3		Opt	Opt	Opt	Opt	Opt	Opt	Opt	Opt	Opt	Opt	Opt	Opt	Opt	Opt	Opt	Opt	Opt	Opt	Opt	Opt	Opt	Opt			
	PAR-CT01MAA Control *3		Opt	Opt	Opt	Opt	Opt	Opt	Opt	Opt	Opt	Opt	Opt	Opt	Opt	Opt	Opt	Opt	Opt	Opt	Opt	Opt	Opt	Opt			
	PAC-YT52CRA Control *3		Opt	Opt	Opt	Opt	Opt	Opt	Opt	Opt	Opt	Opt	Opt	Opt	Opt	Opt	Opt	Opt	Opt	Opt	Opt	Opt	Opt	Opt			
	Centralised On/Off Control *3		Opt	Opt	Opt	Opt	Opt	Opt	Opt	Opt	Opt	Opt	Opt	Opt	Opt	Opt	Opt	Opt	Opt	Opt	Opt	Opt	Opt	Opt	Opt		
	System Group Control *3		Opt	Opt	Opt	Opt	Opt	Opt	Opt	Opt	Opt	Opt	Opt	Opt	Opt	Opt	Opt	Opt	Opt	Opt	Opt	Opt	Opt	Opt	Opt		
	M-NET Connection *3		Opt	Opt	Opt	Opt	Opt	Opt	Opt	Opt	Opt	Opt	Opt	Opt	Opt	Opt	Opt	Opt	Opt	Opt	Opt	Opt	Opt	Opt	Opt		
	Wi-Fi Interface		●	●	●	●	●	●	Opt	Opt	Opt	Opt	Opt	Opt	Opt	Opt	Opt	Opt	Opt	Opt	Opt	Opt	Opt	Opt	Opt		
	MXZ Connection			●*2	●*2	●*2	●*2	●*2	●*2	●*2	●*2	●*2	●*2	●*2	●*2	●*2	●*2	●*2	●*2	●*2	●*2	●*2	●*2	●*2	●*2		
Installation	Cleaning-free Pipe Reuse		●	●	●	●	●	●	●	●	●	●	●	●	●	●	●	●	●	●	●	●	●	●			
	Wiring/Piping Correction Function			●	●	●	●	●			●	●	●	●		●	●	●	●		●	●	●	●			
	Drain Pump																										
	Flare Connection		●	●	●	●	●	●	●	●	●	●	●	●	●	●	●	●	●	●	●	●	●	●	●		
Maintenance	Self-Diagnosis Function (Check Code Display)		●	●	●	●	●	●	●	●	●	●	●	●	●	●	●	●	●	●	●	●	●	●			
	Failure Recall Function		●	●	●	●	●	●	●	●	●	●	●	●	●	●	●	●	●	●	●	●	●	●			

*1 When multiple indoor units connected to an MXZ outdoor unit are running at the same time, simultaneous cooling and heating is not possible.

*2 For the possible connectivity of MXZ outdoor units and indoor units, please refer to the list on pages 111-112 for details.

*3 Please refer to "System Control" on pages 173-184 for details.

*4 When connected to MXZ outdoor units, the outdoor operating sound will not change.

FUNCTION LIST (1)

Category	Icon	M SERIES																
		Combination	Indoor unit	MSZ-HR25/35/42/50VF			MFZ-KJ25/35/50VE2						MLZ-KP25/35/50VF					
				Outdoor unit	MUZ -HR	MXZ -2HA	MXZ -3HA	MUFZ -KJ	MXZ -2D	MXZ -3E	MXZ -4E	MXZ -5E	MXZ -6D	SUZ -M	MXZ -2D/F	MXZ -3E/F	MXZ -4E/F	MXZ -5E
Technology	DC Inverter		●	●	●	●	●	●	●	●	●	●	●	●	●	●	●	●
	Joint Lap DC Motor		●	●	●	●	●	●	72/83VA	●	●	●	●	●	72/83VA	●	●	●
	Reluctance DC Rotary Compressor								83	●	●			83	●	●	●	
	Heating Caulking (Compressor)		●	●	●	●	●	●	72/83VA	●	●	●	●	●	72/83VA	●	●	●
	DC Fan Motor			●	●	●	●	●	●	●	●	●	●	●	●	●	●	●
	PAM (Pulse Amplitude Modulation)		●	●	●	●	●	●	●	●	●	●	●	●	●	●	●	●
	Power Receiver and Twin LEV Control				●				72					●	72			
	Grooved Piping		●	●	●	●	●	●	●	●	●	●	●	●	●	●	●	●
i-see Sensor	Felt Temperature Control (3D i-see Sensor)																	
	AREA Temperature Monitor																	
Energy Saving	Econo Cool Energy-saving Feature		●	●	●	●	●	●	●	●	●	●	●	●	●	●	●	
	Standby Power Consumption Cut					●												
Air Quality	Plasma Quad Plus																	
	Plasma Quad																	
	Dual Barrier Coating																	
	Silver-ionized Air Purifier Filter		Opt			●	●	●	●	●	●	Opt	Opt	Opt	Opt	Opt	Opt	
	Air Purifying Filter																	
Air Distribution	Double Vane																	
	Horizontal Vane		●	●	●	●	●	●	●	●	●	●	●	●	●	●	●	
	Vertical Vane											●	●	●	●	●	●	
	High Ceiling Mode											●	●	●	●	●	●	
	Auto Fan Speed Mode		●	●	●	●	●	●	●	●	●	●	●	●	●	●	●	
Convenience	On/off Operation Timer		●	●	●	●	●	●	●	●	●	●	●	●	●	●	●	
	"i save" Mode		●			●	●	●	●	●	●	●	●	●	●	●	●	
	Auto Changeover		●*1			●*1	●*1	●*1	●*1	●*1	●*1	●*1	●*1	●*1	●*1	●*1	●*1	
	Auto Restart		●	●	●	●	●	●	●	●	●	●	●	●	●	●	●	
	Low-temperature Cooling		●	●	●	●	●	●	●	●	●	●	●	●	●	●	●	
	10°C Heating		●															
	Low-noise Operation (Outdoor Unit)			●	●			●	●	●	●			●	●	●	●	
	Night Mode																	
	Ampere Limit Adjustment						2E		83	●	●			2E		83	●	●
	Operation Lock (Indoor)		●															
	Operation Lock (Outdoor)						●	●	●	●	●			●	●	●	●	●
	Built-in Weekly Timer Function			●	●	●	●	●	●	●	●	●	●	●	●	●	●	●
System Control	PAR-40MAA Control *3		Opt	Opt	Opt	Opt	Opt	Opt	Opt	Opt	Opt	Opt	Opt	Opt	Opt	Opt	Opt	
	PAR-CT01MAA Control *3		Opt	Opt	Opt	Opt	Opt	Opt	Opt	Opt	Opt	Opt	Opt	Opt	Opt	Opt	Opt	
	PAC-YT52CRA Control *3		Opt	Opt	Opt	Opt	Opt	Opt	Opt	Opt	Opt	Opt	Opt	Opt	Opt	Opt	Opt	
	Centralised On/Off Control *3		Opt	Opt	Opt	Opt	Opt	Opt	Opt	Opt	Opt	Opt	Opt	Opt	Opt	Opt	Opt	
	System Group Control *3		Opt	Opt	Opt	Opt	Opt	Opt	Opt	Opt	Opt	Opt	Opt	Opt	Opt	Opt	Opt	
	M-NET Connection *3		Opt	Opt	Opt	Opt	Opt	Opt	Opt	Opt	Opt	Opt	Opt	Opt	Opt	Opt	Opt	
	Wi-Fi Interface		Opt	Opt	Opt	Opt	Opt	Opt	Opt	Opt	Opt	Opt	Opt	Opt	Opt	Opt	Opt	
	MXZ Connection			●*2	●*2	●*2	●*2	●*2	●*2	●*2	●*2			●*2	●*2	●*2	●*2	●*2
Installation	Cleaning-free Pipe Reuse		●	●	●	●	●	●	●	●	●	●	●	●	●	●	●	
	Wiring/Piping Correction Function			●	●			●	●	●	●	●	●	●	●	●	●	
	Drain Pump												●	●	●	●	●	
	Flare Connection		●	●	●	●	●	●	●	●	●	●	●	●	●	●	●	
Maintenance	Self-Diagnosis Function (Check Code Display)		●	●	●	●	●	●	●	●	●	●	●	●	●	●	●	
	Failure Recall Function		●	●	●	●	●	●	●	●	●	●	●	●	●	●	●	

*1 When multiple indoor units connected to an MXZ outdoor unit are running at the same time, simultaneous cooling and heating is not possible.

*2 For the possible connectivity of MXZ outdoor units and indoor units, please refer to the list on pages 111-112 for details.

*3 Please refer to "System Control" on pages 173-184 for details.

• The figures listed in the table are "only when combined with an outdoor unit with the appropriate capacity range".
 • Opt: Separate parts must be purchased.



FUNCTION LIST (2)

Category	Icon	P SERIES																									
		Combination	Indoor unit	PLA-M35/50/60/71/100/125/140EA												PEAD-M35/50/60/71/100/125/140JA(L)											
				Outdoor unit	PUHZ -SHW	PUZ -ZM	PUHZ -ZRP	SUZ -M	SUZ -KA	PUZ -M	PUHZ -P	MXZ -3E/F	MXZ -4E/F	MXZ -5E/F	MXZ -6D	PUHZ -SHW	PUZ -ZM	PUHZ -ZRP	PUZ -M	PUHZ -P	SUZ -M	SUZ -KA	MXZ -3E/F	MXZ -4E/F	MXZ -5E/F	MXZ -6D	
Technology	DC Inverter		●	●	●	●	●	●	●	●	●	●	●	●	●	●	●	●	●	●	●	●	●	●			
	Joint Lap DC Motor			35-71	35-71	●	●	100	100	●	72/83VA	●						35-71	35-71	100	100	●	●	●	72/83VA	●	
	Magnetic Flux Vector Sine Wave Drive		●	●	●				●	●							●	●	●	●	●						
	Reluctance DC Rotary Compressor			35-71	35-71	●	●			100-140		83	●	●				35-71	35-71	●	100-140	●	●		83	●	●
	Highly Efficient DC Scroll Compressor		●	100-140	100-250					200-250						●	100-140	100-250		200/250							
	Heating Caulking (Compressor)			35-71	35-71	●	●	100	100	●	72/83VA	●						35-71	35-71	100	100	●	●	●	72/83VA	●	
	DC Fan Motor		●	●	●	●	●	●	●	●	●	●	●	●	●	●	●	●	●	●	●	●	●	●	●	●	●
	Vector-Wave Eco Inverter		●	●	●					●							●	●	●	●	●						
	PAM (Pulse Amplitude Modulation)		●	●	35-140	●	●	100-140V	100-140V	●	●	●	●	●	●	●	●	35-140	100-140V	100-140V	●	●	●	●	●	●	●
	Power Receiver and Twin LEV Control		●	●	35-140			100-140V	100-140	●	72					●	●	35-140		100-140			●	72			
	Grooved Piping		●	●	●	●	●	●	●	●	●	●	●	●	●	●	●	●	●	●	●	●	●	●	●	●	●
Functions	i-see Sensor	Felt Temperature Control (3D i-see Sensor)	Opt	Opt	Opt	Opt	Opt	Opt	Opt	Opt	Opt	Opt	Opt	Opt													
		AREA Temperature Monitor	Opt	Opt	Opt	Opt	Opt	Opt	Opt	Opt	Opt	Opt	Opt	Opt													
	Energy Saving	Demand Function	Opt	Opt	Opt			Opt	Opt						Opt	Opt	Opt	Opt	Opt								
		Attractive	Pure White	●	●	●	●	●	●	●	●	●	●	●	●												
	Auto Vane		●	●	●	●	●	●	●	●	●	●	●	●													
	Air Quality	Fresh-air Intake	●	●	●	●	●	●	●	●	●	●	●	●													
		High-efficiency Filter	Opt	Opt	Opt	Opt	Opt	Opt	Opt	Opt	Opt	Opt	Opt														
		Oil Mist Filter																									
		Long-life Filter	●	●	●	●	●	●	●	●	●	●	●	●	●	●	●	●	●	●	●	●	●	●	●	●	●
	Air Distribution	Filter Check Signal	●	●	●	●	●	●	●	●	●	●	●	●	●	●	●	●	●	●	●	●	●	●	●	●	●
		Horizontal Vane	●	●	●	●	●	●	●	●	●	●	●	●													
		Vertical Vane																									
		High Ceiling Mode	●	●	●	●	●	●	●	●	●	●	●	●													
		Low Ceiling Mode	●	●	●	●	●	●	●	●	●	●	●	●													
	Convenience	Auto Fan Speed Mode	●	●	●	●	●	●	●	●	●	●	●	●	●	●	●	●	●	●	●	●	●	●	●	●	●
		On/off Operation Timer	●	●	●	●	●	●	●	●	●	●	●	●	●	●	●	●	●	●	●	●	●	●	●	●	●
		Auto Changeover	●	●	●	●	●	●	●	●	●	●	●	●	●	●	●	●	●	●	●	●	●	●	●	●	●
		Auto Restart	●	●	●	●	●	●	●	●	●	●	●	●	●	●	●	●	●	●	●	●	●	●	●	●	●
Low-temperature Cooling		●	●	●	●	●	●	●	●	●	●	●	●	●	●	●	●	●	●	●	●	●	●	●	●	●	
Low-noise Operation (Outdoor Unit)		●	●	●						●	●	●	●	●	●	●	●	●	●	●	●	●	●	●	●	●	
Ampere Limit Adjustment		112/140	60-140V	60-140V	200/250							83	●	●	112/140	60-140V	60-140V	200/250					83	●	●		
Operation Lock											●	●	●	●													
Rotation, Back-up and 2nd Stage Cut-in Functions		●	●	●						●	●				●	●	●	●	●								
Dual Set Point *6			●	●						●	●					●	●	●	●								
System Control	PAR-40MAA Control *3	Opt	Opt	Opt	Opt	Opt	Opt	Opt	Opt	Opt	Opt	Opt	Opt	Opt	Opt	Opt	Opt	Opt	Opt	Opt	Opt	Opt	Opt	Opt	Opt	Opt	
	PAR-CT01MAA Control *3	Opt	Opt	Opt	Opt	Opt	Opt	Opt	Opt	Opt	Opt	Opt	Opt	Opt	Opt	Opt	Opt	Opt	Opt	Opt	Opt	Opt	Opt	Opt	Opt	Opt	
	PAC-YT52CRA Control *3	Opt	Opt	Opt	Opt	Opt	Opt	Opt	Opt	Opt	Opt	Opt	Opt	Opt	Opt	Opt	Opt	Opt	Opt	Opt	Opt	Opt	Opt	Opt	Opt	Opt	
	Centralised On/Off Control *3	Opt	Opt	Opt	Opt	Opt	Opt	Opt	Opt	Opt	Opt	Opt	Opt	Opt	Opt	Opt	Opt	Opt	Opt	Opt	Opt	Opt	Opt	Opt	Opt	Opt	
	System Group Control *3	●	●	●	Opt	Opt	●	●	Opt	Opt	Opt	Opt	Opt	●	●	●	●	●	Opt	Opt	Opt	Opt	Opt	Opt	Opt	Opt	
	M-NET Connection *3	Opt	Opt	Opt	Opt	Opt	Opt	Opt	Opt	Opt	Opt	Opt	Opt	Opt	Opt	Opt	Opt	Opt	Opt	Opt	Opt	Opt	Opt	Opt	Opt	Opt	
	COMPO *4	●	71-140	71-250				●	●					●	71-140	71-250	●	●									
	MXZ Connection										●	*2	●	*2	●	*2	●	*2					●	*2	●	*2	
Installation	Cleaning-free Pipe Reuse	●	●	●	●	●	●	●	●	●	●	●	●	●	●	●	●	●	●	●	●	●	●	●	●	●	
	Reuse of Existing Wiring	Opt	Opt	Opt			Opt	Opt						Opt	Opt	Opt	Opt	Opt									
	Wiring/Piping Correction Function										●	●	●	●							●	●	●	●			
	Drain Pump	●	●	●	●	●	●	●	●	●	●	●	●	●	●	●	●	●	●	●	●	●	●	●	●	●	
	Pump Down Switch	●	●	●			●	●						●	●	●	●	●				●	●	●	●		
	Flare Connection	●	●	●	●	●	●	●	●	●	●	●	●	●	●	●	●	●	●	●	●	●	●	●	●	●	
Maintenance	Self-Diagnosis Function (Check Code Display)	●	●	●	●	●	●	●	●	●	●	●	●	●	●	●	●	●	●	●	●	●	●	●	●		
	Failure Recall Function	●	●	●	●	●	●	●	●	●	●	●	●	●	●	●	●	●	●	●	●	●	●	●	●		

*1 When multiple indoor units connected to an MXZ outdoor unit are running at the same time, simultaneous cooling and heating is not possible.
 *2 For the possible connectivity of MXZ outdoor units and indoor units, please refer to the list on pages 111-112 for details.
 *3 Please refer to "System Control" on pages 173-184 for details.
 *4 Please refer to page 62 for details.
 *5 PEAD-M JAL are not equipped with a drain pump.
 *6 This function is only available with PAR-40MAA, PAC-YT52CRA.

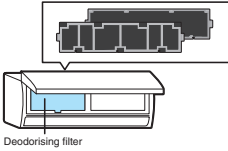
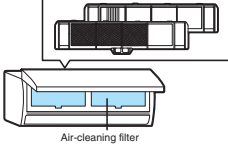
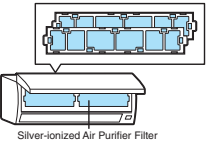
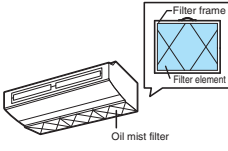
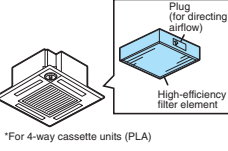
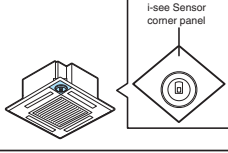
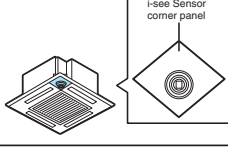
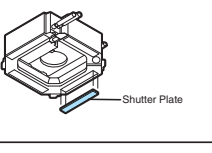
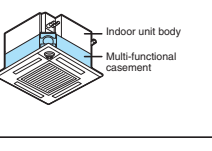
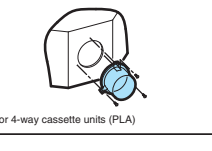
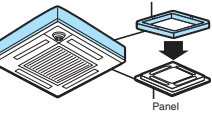
Major Optional Parts

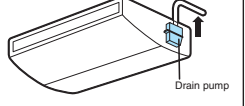
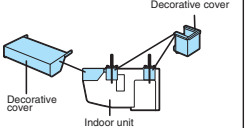
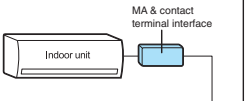
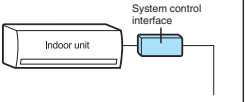
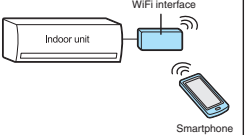
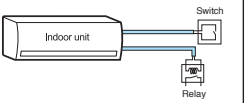
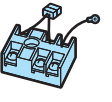
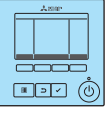
Part Name	Description
Deodorising Filter Captures small foul-smelling substances in the air.	 <p>Deodorising filter</p>
Air-cleaning Filter Removes fine dust particles from the air by means of static electricity.	 <p>Air-cleaning filter</p>
Silver-ionized Air Purifier Filter Captures the bacteria, pollen and other allergens in the air and neutralises them.	 <p>Silver-ionized Air Purifier Filter</p>
Oil Mist Filter Element Filter element (12 pieces) that blocks the oil mist for ceiling-suspended models used in professional kitchens.	 <p>Oil mist filter</p>
High-efficiency Filter Element Element for high-efficiency filter. Removes fine dust particles from the air.	 <p>High-efficiency filter element</p> <p>*For 4-way cassette units (PLA)</p>
3D i-see Sensor Corner Panel for SLZ Corner panel holding the 3D i-see Sensor.	 <p>i-see Sensor corner panel</p>
3D i-see Sensor Corner Panel for PLA Corner panel holding the 3D i-see Sensor.	 <p>i-see Sensor corner panel</p>
Shutter Plate Plate for blocking an air outlet of the 4-way cassette (PLA) indoor unit.	 <p>Shutter Plate</p>
Multi-functional Casement Casement for fresh-air intake and attaching the high-efficiency filter element (optional).	 <p>Indoor unit body</p> <p>Multi-functional casement</p>
Fresh-air Intake Duct Flange Flange attachment for adding a duct to take in fresh air from outside.	 <p>*For 4-way cassette units (PLA)</p>
Space Panel Decorative cover for the installation when the ceiling height is low.	 <p>Space Panel</p> <p>Panel</p>

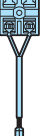
Part Name	Description
Drain Pump Pumps drain water to a point higher than that where the unit is installed.	 <p>Drain pump</p> <p>*for ceiling-suspended units</p>
Decorative Cover To be attached to the upper section of ceiling-suspended models for professional kitchen use. Helps prevent dust accumulation.	 <p>Decorative cover</p> <p>Indoor unit</p>
MA & Contact Terminal Interface Interface for connecting with the PAR-40MAA remote controller and PAC-YT52CRA, and to relay operation signals.	 <p>MA & contact terminal interface</p> <p>Indoor unit</p>
System Control Interface Interface to connect with M-NET controllers.	 <p>System control interface</p> <p>Indoor unit</p>
Wi-Fi Interface Interface enabling users to control air conditioners and check operating status via devices such as personal computers, tablets and smartphones.	 <p>WiFi interface</p> <p>Indoor unit</p> <p>Smartphone</p>
Connector Cable This product is an adaptor which inputs the incoming signals from an open/close switch to the air conditioner and outputs the on/off signals from the air conditioner to the back-up heater.	 <p>Indoor unit</p> <p>Switch</p> <p>Relay</p>
Power Supply Terminal Kit Terminal bed to change the power supply from outdoor power supply to separate indoor/outdoor power supplies.	
Wired Remote Controller Advanced deluxe remote controller with full-dot liquid-crystal display and backlight. Equipped with convenient functions like night-setback.	
MA Touch Remote Controller Remote controller with the full color touch display. Smartphone/Tablet App is available for setting, customize and control.	
Simple Wired Remote Controller Remote controller with liquid-crystal display, and backlight function for operation in dark location.	
Remote Controller Terminal Block Kit for PKA The terminal block is used as a relay to wire an indoor unit and to two remote controllers or to wire a remote controller and multiple indoor units in order to perform group control.	

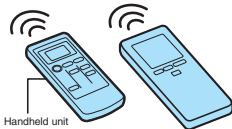
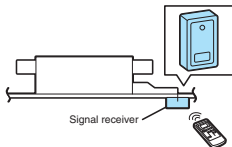
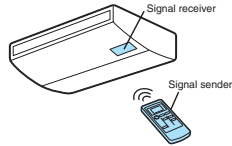
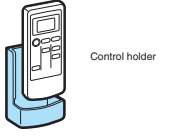
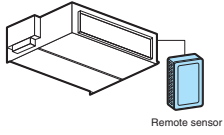
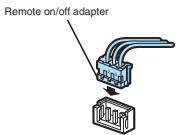
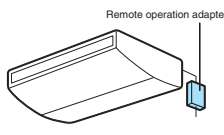
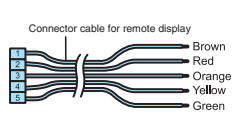
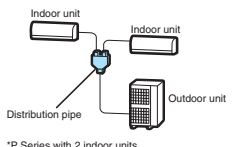
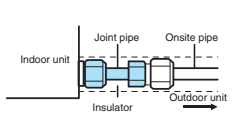
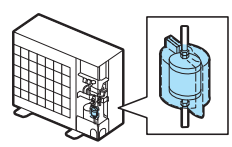
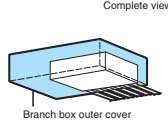
Part Name	Description
Wireless Remote Controller Signal Sender Handheld unit for sending operation signals to the indoor unit.	 Handheld unit
Wireless Remote Controller Signal Receiver Receives operation signals from the wireless remote controller handheld unit.	 Signal receiver
Wireless Remote Controller Kit (Sender & Receiver) Remote controller handheld unit (signal sender) and receiver (signal receiver) for ceiling-suspended units.	 Signal receiver Signal sender
Control Holder Holder for storing the remote controller.	 Control holder
Remote Sensor Sensor to detect the room temperature at remote positions.	 Remote sensor
Remote On/Off Adapter Connector for receiving signals from the local system to control the on/off function.	 Remote on/off adapter
Remote Operation Adapter Adapter to display the operation status and control on/off function from a distance.	 Remote operation adapter
Connector Cable for Remote Display Connector used to display the operation status and control on/off function from a distance.	 Connector cable for remote display Brown Red Orange Yellow Green
Distribution Pipe Branch pipe for P Series simultaneous multi-system use, or to connect two branch boxes for PUMY.	 Indoor unit Indoor unit Distribution pipe Outdoor unit *P Series with 2 indoor units
Joint Pipe Part for connecting refrigerant pipes of different diameters.	 Indoor unit Joint pipe Onsite pipe Insulator Outdoor unit
Liquid Refrigerant Dryer Removes water and minute particles from refrigerant pipes.	
Branch Box Outer Cover Casement for branch boxes.	 Complete view Branch box outer cover

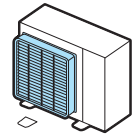
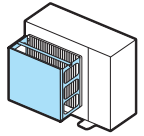
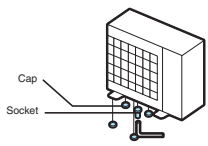
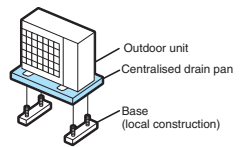
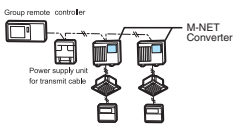
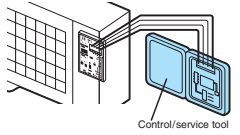
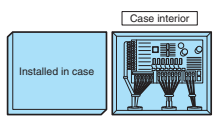
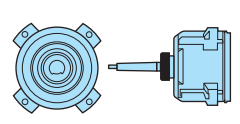
Part Name	Description
Air Discharge Guide Changes the direction of air being exhausted from the outdoor unit.	
Air Protection Guide Protects the outdoor unit from the wind.	
Drain Socket A set of caps to cover unnecessary holes at the bottom of the outdoor unit, and a socket to guide drain water to the local drain pipe.	 Cap Socket
Centralised Drain Pan Catches drain water generated by the outdoor unit.	 Outdoor unit Centralised drain pan Base (local construction)
M-NET Converter Used to connect P Series A-control models to M-NET controllers.	 Group remote controller Power supply unit for transmit cable M-NET Converter
Control/Service Tool Monitoring tool to display operation and self-diagnosis data.	 Control/service tool
Step Interface Interface for adjusting the capacity of inverter-equipped outdoor units.	 Case interior Installed in case
High-static Fan Motor Static pressure enhanced up to +30pa.	

Optional Parts List <Indoor>

Indoor Unit		Option	Filter										Wired Remote Controller							
			Silver-ionized Air Purifier Filter					Deodorising Filter		Air Purifying Filter	Softdry cloth	System Control Interface	MA & Contact Terminal Interface	Wi-Fi Interface	Connector Cable		Controller			Controller Holder
			MAC-2360 FT	MAC-2370 FT	MAC-2380 FT	MAC-2390 FT	MAC-172 FT-E	MAC-3000 FT-E	MAC-3010 FT-E	MAC-3005 CF-E	MAC-1001 CL-E	MAC-334IF-E	MAC-397IF-E	MAC-567IF-E	MAC-1702RA-E	MAC-1710RA-E	PAR-40MAA	PAR-CT01MAA	PAC-YT52CRA	MAC-1200RC
M SERIES	Wall-mounted	MSZ-LN18VG(W)(V)(R)(B)				●			●			●		●		●	●	●	●	●
		MSZ-LN25VG(W)(V)(R)(B)				●			●			●		●		●	●	●	●	●
		MSZ-LN35VG(W)(V)(R)(B)				●			●			●		●		●	●	●	●	●
		MSZ-LN50VG(W)(V)(R)(B)				●			●			●		●		●	●	●	●	●
		MSZ-LN60VG(W)(V)(R)(B)				●			●			●		●		●	●	●	●	●
	MSZ-AP15VF															●	●	●	●	●
	MSZ-AP20VF															●	●	●	●	●
	MSZ-AP25VG		●													●	●	●	●	●
	MSZ-AP35VG		●													●	●	●	●	●
	MSZ-AP42VG		●													●	●	●	●	●
	MSZ-AP50VG		●													●	●	●	●	●
	MSZ-FH25VE2			●				●						●		●	●	●	●	●
	MSZ-FH35VE2			●				●						●		●	●	●	●	●
	MSZ-FH50VE2			●				●						●		●	●	●	●	●
	MSZ-EF18VG(W)(B)(S)		●								●			●		●	●	●	●	●
	MSZ-EF22VG(W)(B)(S)		●								●			●		●	●	●	●	●
	MSZ-EF25VG(W)(B)(S)		●								●			●		●	●	●	●	●
	MSZ-EF35VG(W)(B)(S)		●								●			●		●	●	●	●	●
	MSZ-EF42VG(W)(B)(S)		●								●			●		●	●	●	●	●
	MSZ-EF50VG(W)(B)(S)		●								●			●		●	●	●	●	●
	MSZ-SF15VA															●	●	●	●	●
	MSZ-SF20VA															●	●	●	●	●
	MSZ-SF25VE3			●												●	●	●	●	●
	MSZ-SF35VE3			●												●	●	●	●	●
	MSZ-SF42VE3			●												●	●	●	●	●
	MSZ-SF50VE3			●												●	●	●	●	●
	MSZ-GF60VE2		●													●	●	●	●	●
	MSZ-GF71VE2		●													●	●	●	●	●
	MSZ-WN25VA			●											●	●	●	●	●	●
	MSZ-WN35VA			●											●	●	●	●	●	●
	MSY-TP35VF			●												●	●	●	●	●
	MSY-TP50VF			●												●	●	●	●	●
	MSZ-DM25VA			●												●	●	●	●	●
	MSZ-DM35VA			●												●	●	●	●	●
	MSZ-HJ25VA			●												●	●	●	●	●
	MSZ-HJ35VA			●												●	●	●	●	●
	MSZ-HJ50VA			●												●	●	●	●	●
	MSZ-HJ60VA			●												●	●	●	●	●
	MSZ-HJ71VA			●												●	●	●	●	●
	MSZ-HR25VF			●												●	●	●	●	●
MSZ-HR35VF			●												●	●	●	●	●	
MSZ-HR42VF			●												●	●	●	●	●	
MSZ-HR50VF			●												●	●	●	●	●	
Floor-standing	MFZ-KJ25VE2		●												●	●	●	●	●	
	MFZ-KJ35VE2		●												●	●	●	●	●	
	MFZ-KJ50VE2		●												●	●	●	●	●	
1-way cassette	MLZ-KP25VF		●												●	●	●	●	●	
	MLZ-KP35VF		●												●	●	●	●	●	
	MLZ-KP50VF		●												●	●	●	●	●	

*1 MAC-334IF-E or MAC-397IF-E is required.

Optional Parts List <Indoor>

Option		Filter								3D i-see Sensor Corner Panel	Shutter Plate	Multi- functional Casement	Fresh-air Intake Duct Flange	Space Panel	Drain Pump							Decorative Cover		System Control Interface										
		Oil Mist Filter Element	High-efficiency Filter Element			Filter Box									PAC- SF1 ME-E	PAC- SE1 ME-E	PAC- SJ37 SP-E	PAC- SJ41 TM-E	PAC- SH65 OF-E	PAC- SF28 OF-E	PAC- SJ65 AS-E	PAC- SH94 DM-E	PAC- SH75 DM-E		PAC- SJ92 DM-E	PAC- SJ93 DM-E	PAC- SJ94 DM-E	PAC- KE07 DM-E	PAC- SF81 KC-E	PAC- SF82 KC-E	MAC- 334IF-E			
			PAC- SG38 KF-E	PAC- SH59 KF-E	PAC- SH88 KF-E	PAC- SH89 KF-E	PAC- SH90 KF-E	PAC- KE92 TB-E	PAC- KE93 TB-E																							PAC- KE94 TB-E	PAC- KE95 TB-E	
S SERIES	4-way cassette	SLZ-M15FA																																
		SLZ-M25FA																																
		SLZ-M35FA																																
		SLZ-M50FA																																
		SLZ-M60FA																																
	Ceiling - conceald	SEZ-M25DA(L)																																
		SEZ-M35DA(L)																																
		SEZ-M50DA(L)																																
		SEZ-M60DA(L)																																
		SEZ-M71DA(L)																																
P SERIES	4-way Cassette	PLA-ZM35EA																																
		PLA-ZM50EA																																
		PLA-ZM60EA																																
		PLA-ZM71EA																																
		PLA-ZM100EA																																
		PLA-ZM125EA																																
		PLA-ZM140EA																																
		PLA-M35EA																																
		PLA-M50EA																																
		PLA-M60EA																																
		PLA-M71EA																																
		PLA-M100EA																																
		PLA-M125EA																																
		PLA-M140EA																																
	Ceiling - conceald	PEAD-M35JA(L)																																
		PEAD-M50JA(L)																																
		PEAD-M60JA(L)																																
		PEAD-M71JA(L)																																
		PEAD-M100JA(L)																																
		PEAD-M125JA(L)																																
		PEAD-M140JA(L)																																
		PEA-RP200WKA																																
		PEA-RP250WKA																																
	Wall - mounted	PKA-M35HA(L)																																
		PKA-M50HA(L)																																
		PKA-M60KA(L)																																
		PKA-M71KA(L)																																
		PKA-M100KA(L)																																
	Ceiling - suspended	PCA-M35KA																																
		PCA-M50KA																																
		PCA-M60KA																																
		PCA-M71KA																																
		PCA-M100KA																																
PCA-M125KA																																		
PCA-M140KA																																		
Floor - standing	PSA-RP71KA																																	
	PSA-RP100KA																																	
	PSA-RP125KA																																	
	PSA-RP140KA																																	

*1 P Series indoor units can be used in combination with SUZ or MXZ outdoor units. *2 Unable to use with wireless remote controller. *3 Two interface components required for each indoor unit. *4 Refrigerant address must be set to 00. *5 PAC-SH29TC-E is required. *6 Group control cannot be used.

External Dimensions

M SERIES

Unit: mm

**MSZ-LN25VG(W)(V)(R)(B) MSZ-LN35VG(W)(V)(R)(B)
MSZ-LN50VG(W)(V)(R)(B) MSZ-LN60VG(W)(V)(R)(B)**

INDOOR UNIT

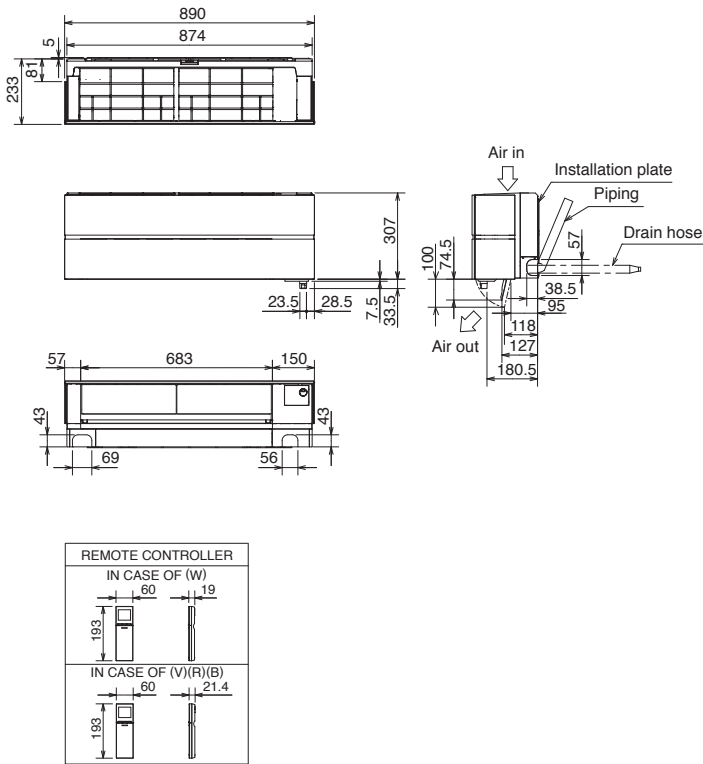

MSZ-AP15VF MSZ-AP20VF

INDOOR UNIT

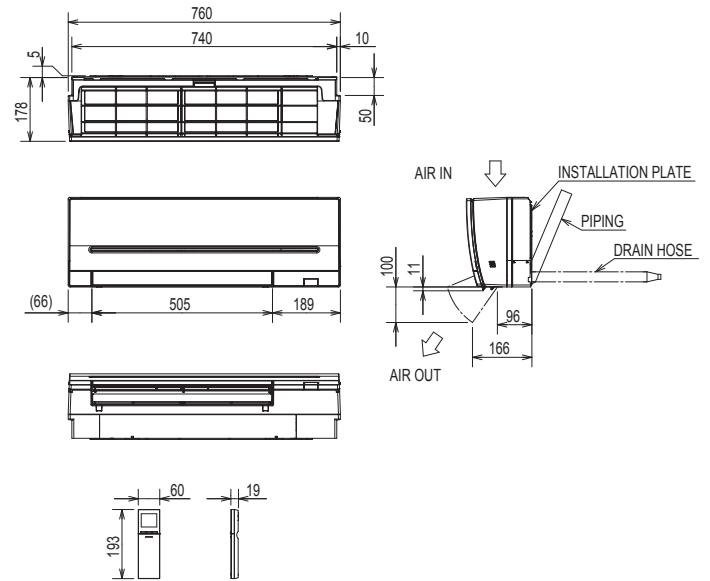

**MSZ-AP25VG MSZ-AP35VG MSZ-AP42VG MSZ-AP50VG
MSZ-AP25VGK MSZ-AP35VGK MSZ-AP42VGK MSZ-AP50VGK**

INDOOR UNIT

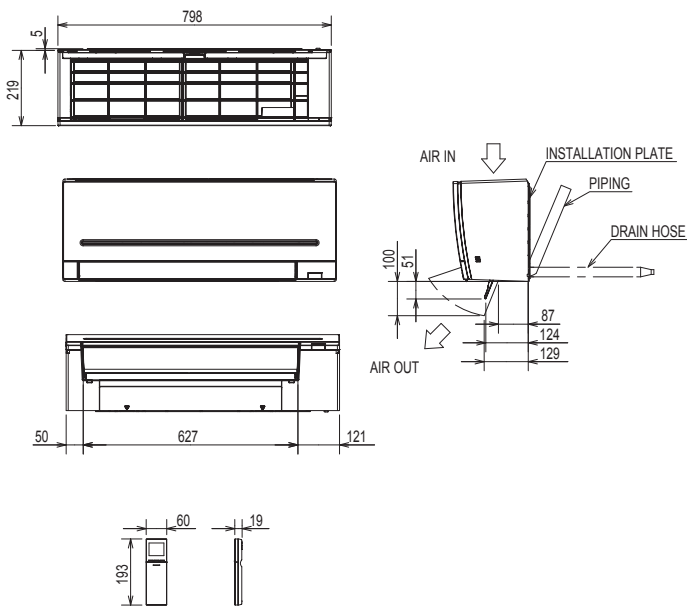

MSZ-FH25VE2 MSZ-FH35VE2 MSZ-FH50VE2

INDOOR UNIT

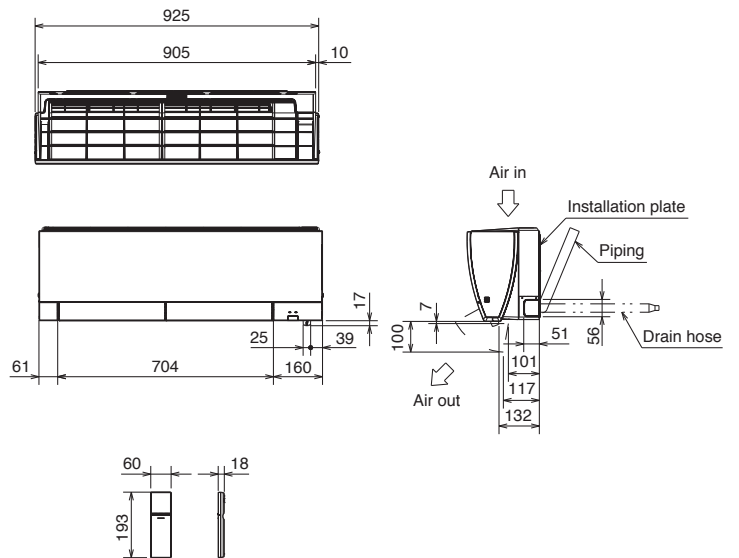

MSZ-EF18VG(W)(B)(S) MSZ-EF22VG(W)(B)(S)
 MSZ-EF25VG(W)(B)(S) MSZ-EF35VG(W)(B)(S)
 MSZ-EF42VG(W)(B)(S) MSZ-EF50VG(W)(B)(S)

INDOOR UNIT

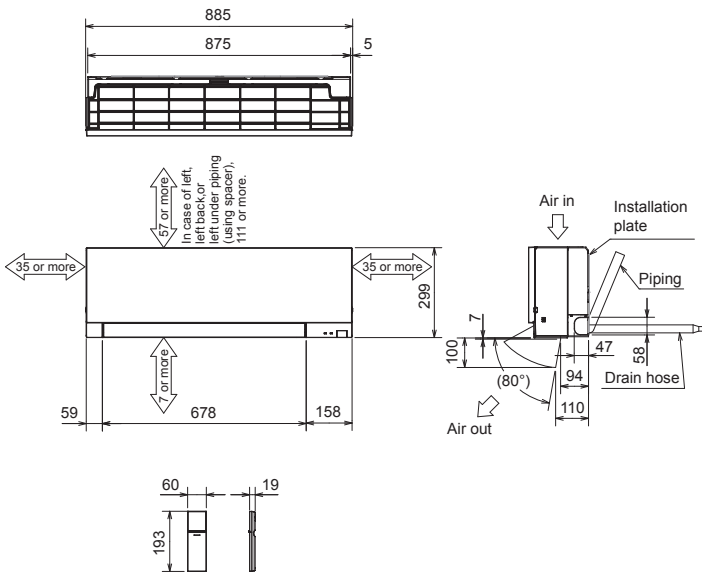

MSZ-SF25VE3 MSZ-SF35VE3 MSZ-SF42VE3
 MSZ-SF50VE3

INDOOR UNIT

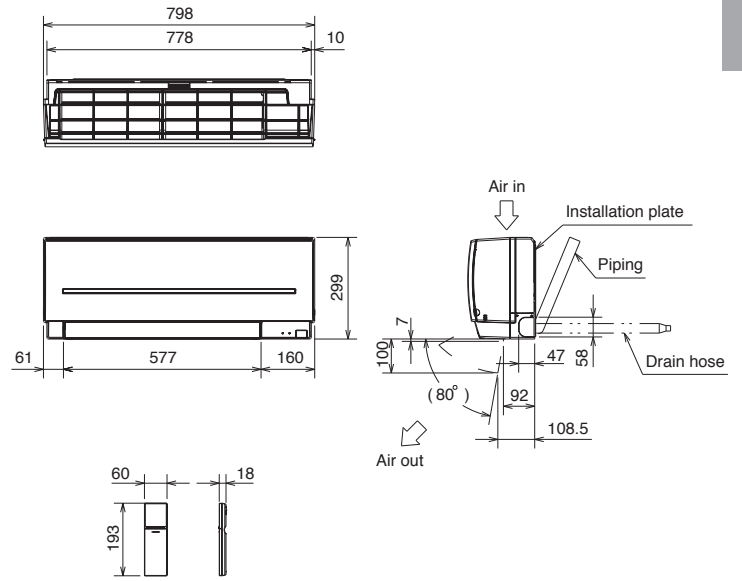

MSZ-GF60VE2 MSZ-GF71VE2

INDOOR UNIT

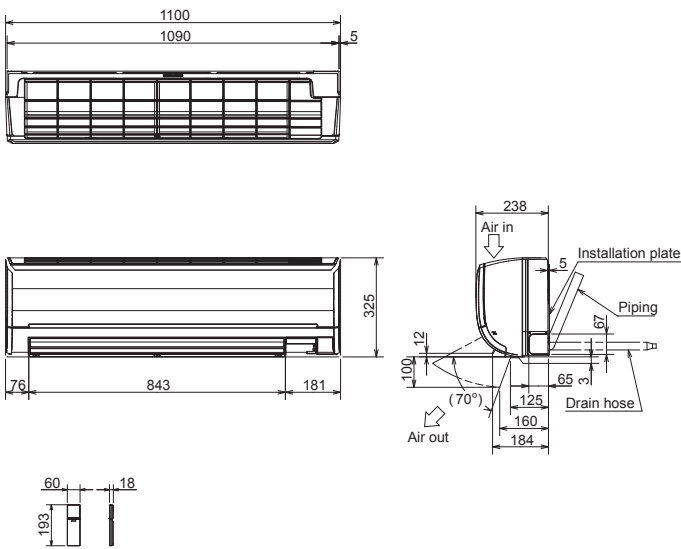

MSZ-WN25VA MSZ-WN35VA

INDOOR UNIT

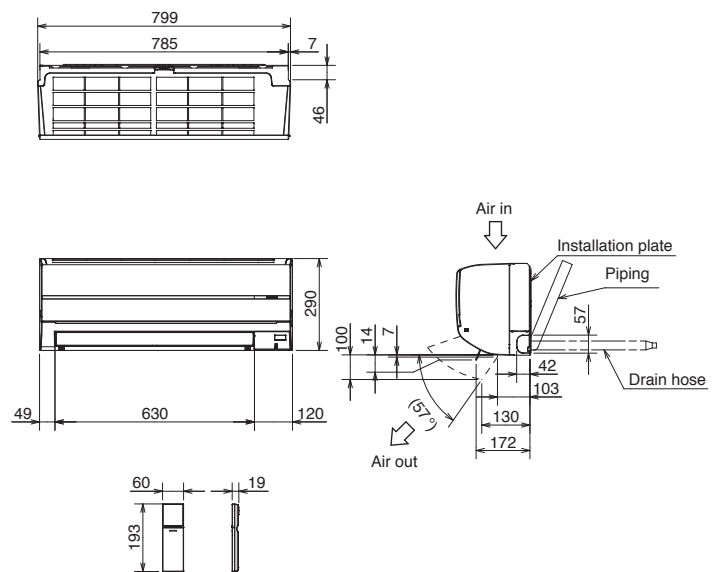

MSZ-DM25VA MSZ-DM35VA

INDOOR UNIT

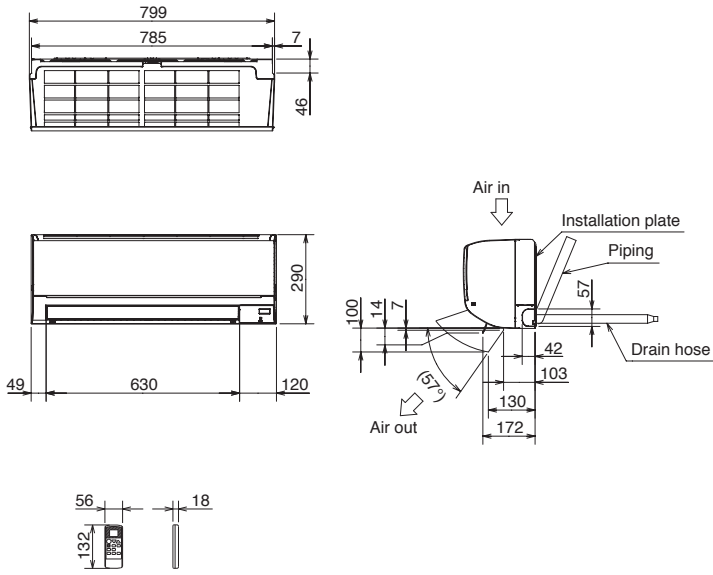

MSZ-HJ25VA MSZ-HJ35VA MSZ-HJ50VA

INDOOR UNIT

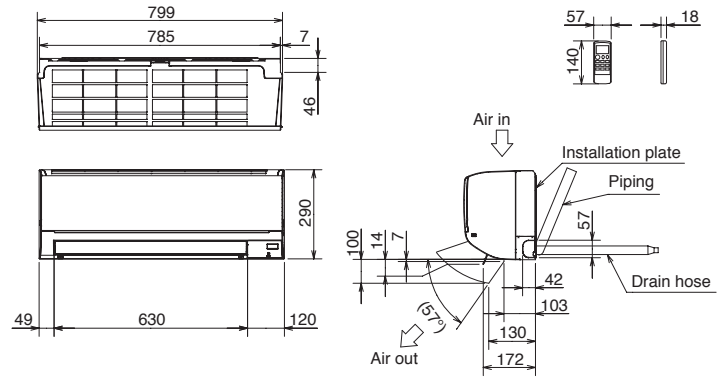

**MSZ-HJ60VA MSZ-HJ71VA
MSY-TP35VF MSY-TP50VF**

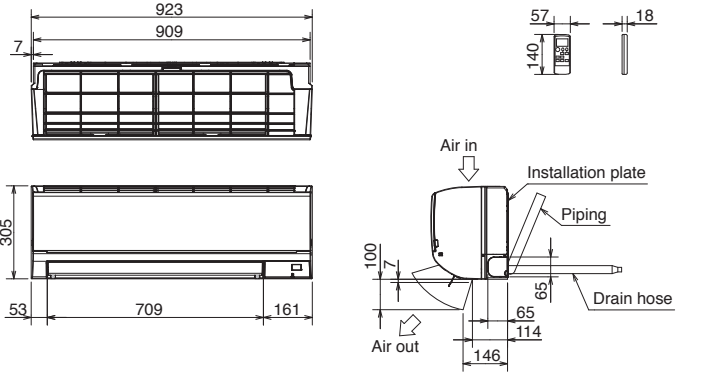

MSZ-SF15VA MSZ-SF20VA

INDOOR UNIT

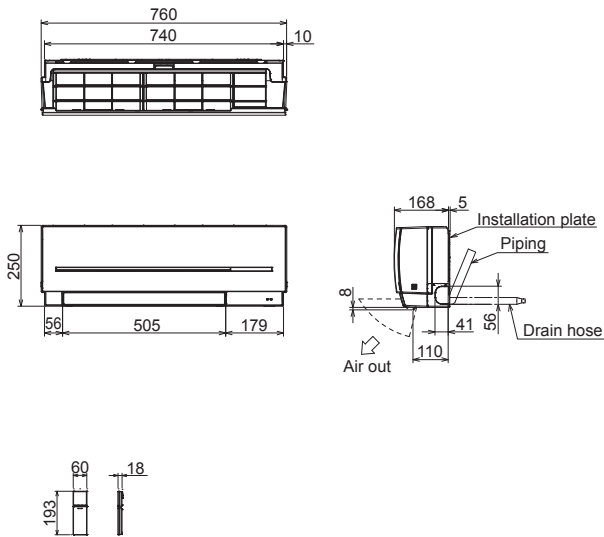

MSZ-HR25VF MSZ-HR35VF MSZ-HR42VF MSZ-HR50VF

INDOOR UNIT

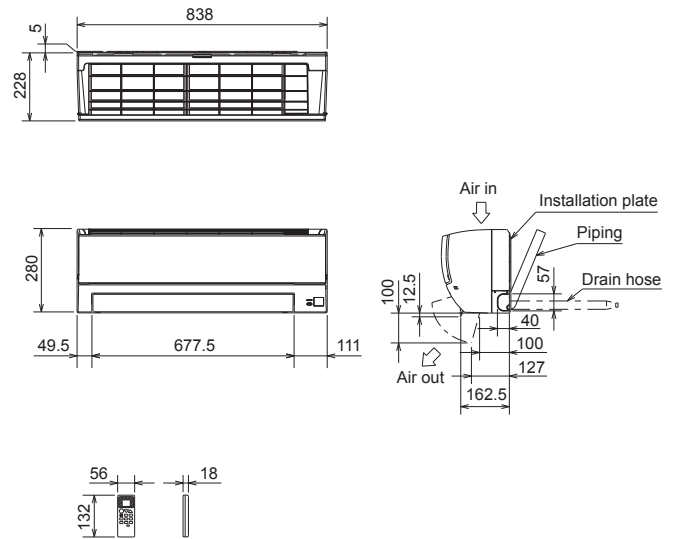

MUZ-HR25VF MUZ-HR35VF

OUTDOOR UNIT

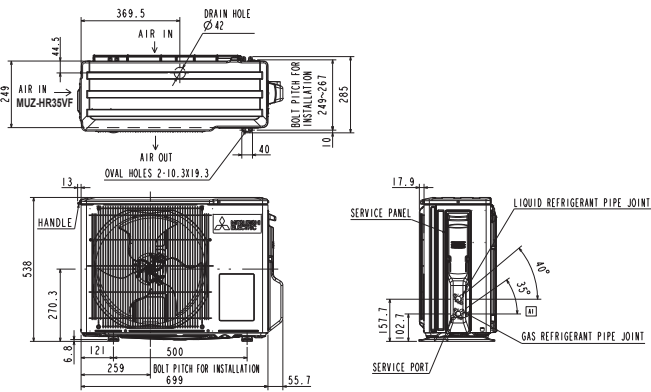

MUZ-HR42VF MUZ-HR50VF

OUTDOOR UNIT

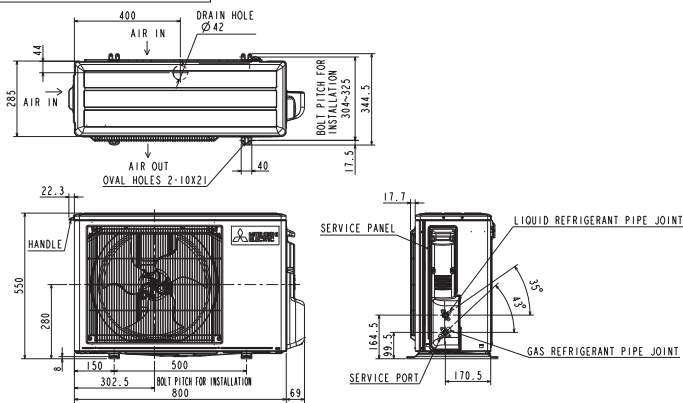

MFZ-KJ25VE2 MFZ-KJ35VE2 MFZ-KJ50VE2

INDOOR UNIT

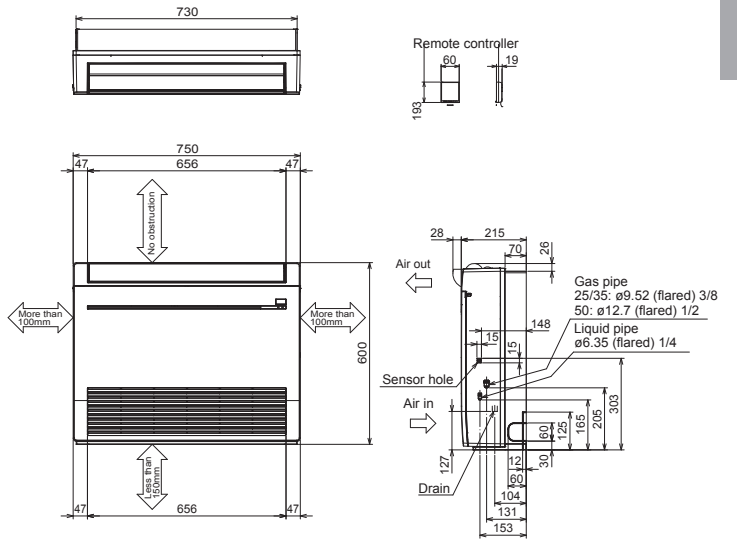

MLZ-KP25VF MLZ-KP35VF MLZ-KP50VF

INDOOR UNIT

INDOOR UNIT OUTLINE DRAWING

(TOP VIEW)

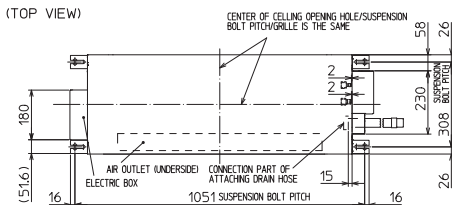

(FRONT VIEW)

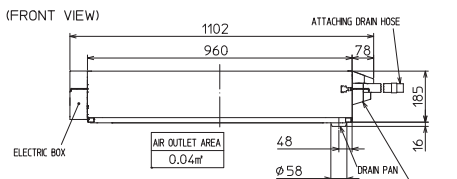

REMOTE CONTROLLER OUTLINE DRAWING

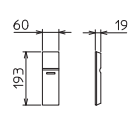

(RIGHT SIDE VIEW)

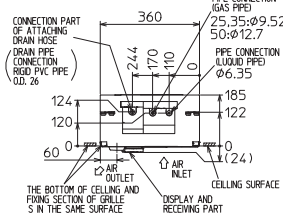

INDOOR UNIT DETAIL VIEW

(TOP VIEW)

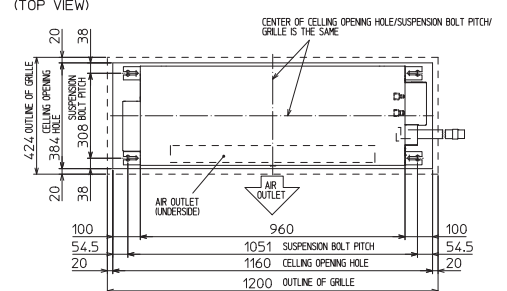

(FRONT VIEW)



GRILLE OUTLINE DRAWING

(MLP-444W)

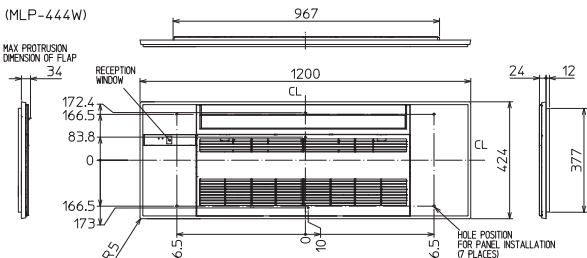

		KP25/35VF	KP50VF
EXTENSION PIPE	LIQUID PIPE O.D.	ø6.35	
	GAS PIPE O.D.	ø9.52	ø12.7
CONNECTION OF PIPE	LIQUID PIPE	FLARED CONNECTION ø6.35	
	GAS PIPE	FLARED CONNECTION ø9.52	FLARED CONNECTION ø12.7
DRAN HOSE	HEAT INSULATOR O.D.	ø32	ø25
DRAN PIPE CONNECTION	CONNECTION I.D.	ø25	ø25
	EFFECTIVE LENGTH	480	
	DRAN PIPE CONNECTION	RIGID PVC PIPE O.D. 26	

NOTE1. CUTTING ATTACHING DRAIN HOSE CAN BE USED.

THE METHOD FOR STANDING DRAIN FROM INDOOR UNIT
* CUTTING ATTACHING DRAIN HOSE CAN BE USED

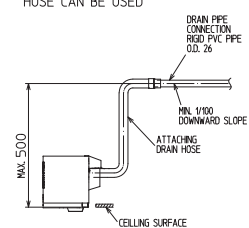

- MUZ-LN25VG MUZ-LN25VGHZ
- MUZ-LN35VG MUZ-LN35VGHZ
- MUZ-AP25VG MUZ-AP25VGH
- MUZ-AP35VG MUZ-AP35VGH
- MUZ-AP42VG MUZ-AP42VGH
- MUZ-FH25VE MUZ-FH25VEH
- MUZ-FH25VEHZ MUZ-FH35VEHZ
- MUZ-EF25VG MUZ-EF25VGH
- MUZ-EF35VG MUZ-EF35VGH
- MUZ-EF42VG MUZ-EF42VGH
- MUZ-SF25VE MUZ-SF25VEH
- MUZ-SF35VEH MUZ-SF35VEHZ
- MUZ-HJ50VA MUZ-HJ50VAH
- MUFZ-KJ25VE MUFZ-KJ25VEH
- MUFZ-KJ25VEHZ MUFZ-KJ35VEHZ

OUTDOOR UNIT

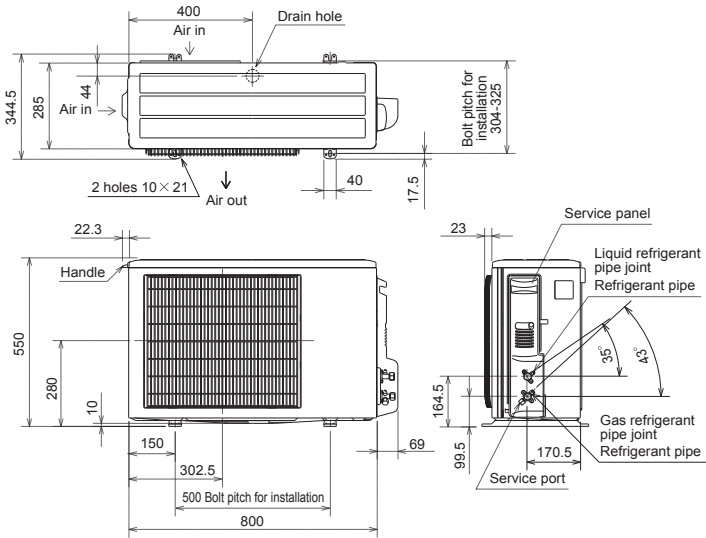

- MUZ-LN50VGHZ MUZ-LN60VG
- MUZ-FH50VE MUZ-FH50VEHZ
- MUZ-SF50VE MUZ-SF50VEH
- MUZ-GF60VE MUZ-GF71VE
- MUZ-HJ60VA MUZ-HJ71VA
- MUFZ-KJ50VE MUFZ-KJ50VEHZ

OUTDOOR UNIT

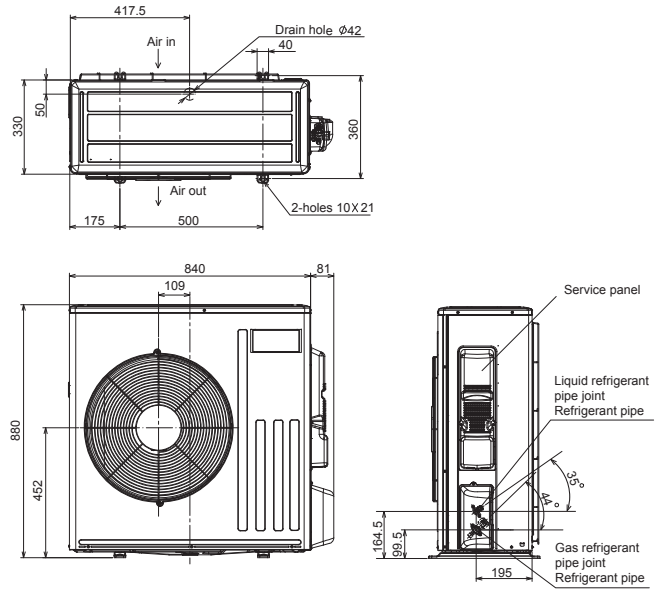

- MUZ-WN25VA MUZ-WN35VA
- MUZ-DM25VA MUZ-DM35VA
- MUZ-HJ25VA MUZ-HJ35VA

OUTDOOR UNIT

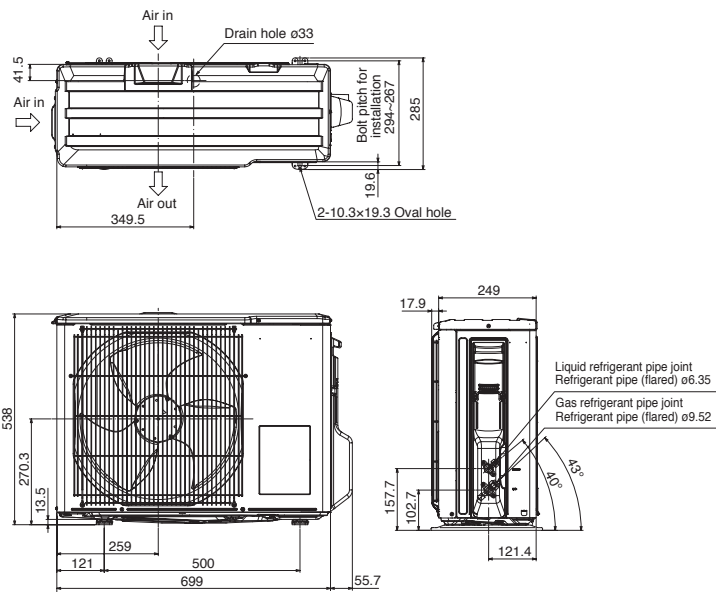

- MUZ-LN50VG MUZ-LN60VGHZ
- MUZ-AP50VG MUZ-AP50VGH
- MUZ-EF50VG

OUTDOOR UNIT

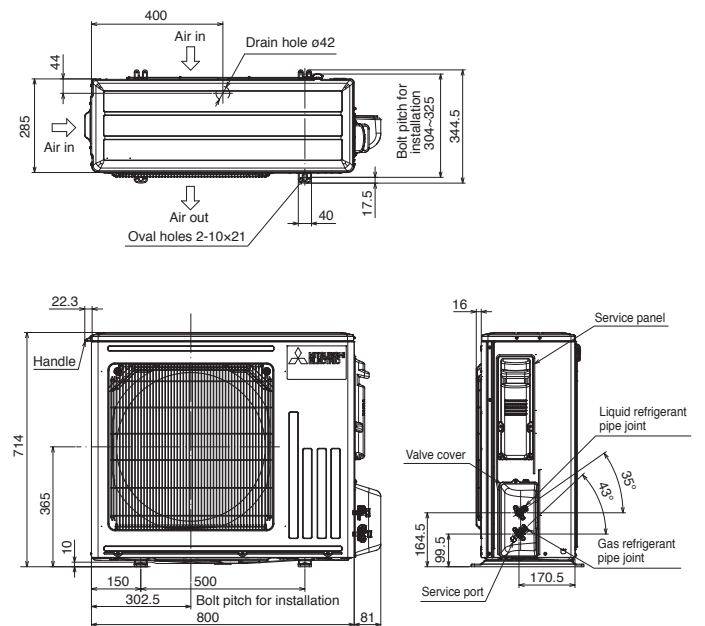

SLZ-M15FA
SLZ-M25FA SLZ-M35FA
SLZ-M50FA SLZ-M60FA

INDOOR UNIT

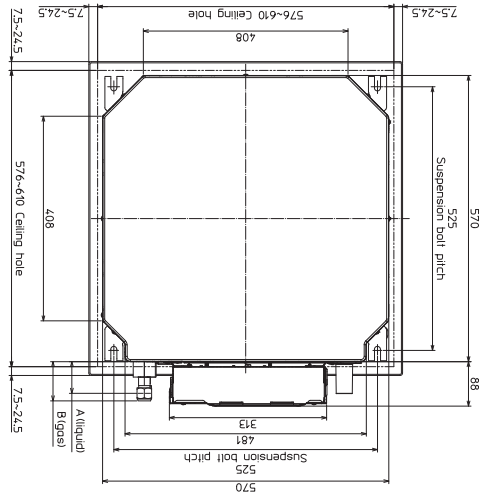

Models	① Refrigerant pipe (liquid)	② Refrigerant pipe (gas)	A	B
SLZ-M15FA SLZ-M25FA SLZ-M35FA	φ 6.35mm flared connection 1/4F	φ 9.52mm flared connection 3/8F	63mm	72mm
SLZ-M50FA	φ 6.35mm flared connection 1/4F	φ 12.7mm flared connection 1/2F	63mm	78mm
SLZ-M60FA	φ 6.35mm flared connection 1/4F	φ 15.88mm flared connection 5/8F	63mm	78mm

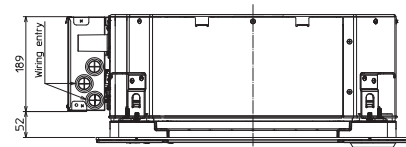
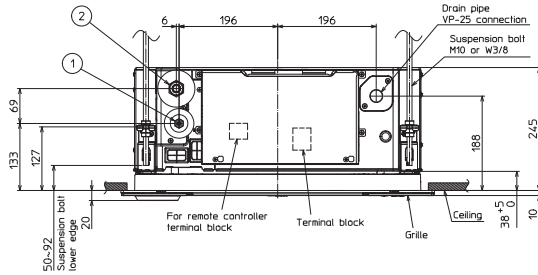

SEZ-M25DA(L) SEZ-M35DA(L) SEZ-M50DA(L) SEZ-M60DA(L) SEZ-M71DA(L)

INDOOR UNIT

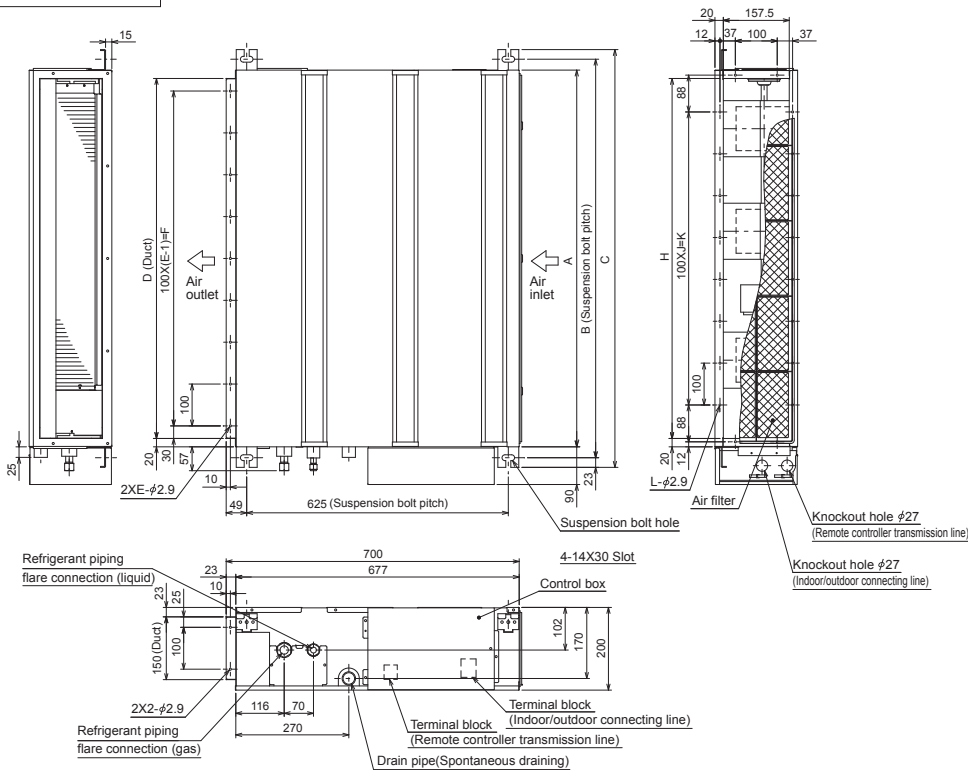

Model	A	B	C	D	E	F	G	H	J	K	L
SEZ-M25DAL/DA	700	752	798	660	7	600	800	660	5	500	16
SEZ-M35DAL/DA	900	952	998	860	9	800	1000	860	7	700	20
SEZ-M50DAL/DA											
SEZ-M60DAL/DA	1100	1152	1198	1060	11	1000	1200	1060	9	900	24
SEZ-M71DAL/DA											

Notes:

1. Use M10 bolts for suspension (purchase locally).
2. Keep service space for maintenance at the bottom.
3. This chart is based on the SEZ-M50DAL/DA, which has three fans.
SEZ-M25, 35DAL/DA has two fans, and SEZ-M60, 71DAL/DA has four fans.
4. If an inlet duct is used, remove the air filter supplied with the unit, and install a locally purchased filter on the suction side.

SUZ-M25VA SUZ-M35VA

OUTDOOR UNIT

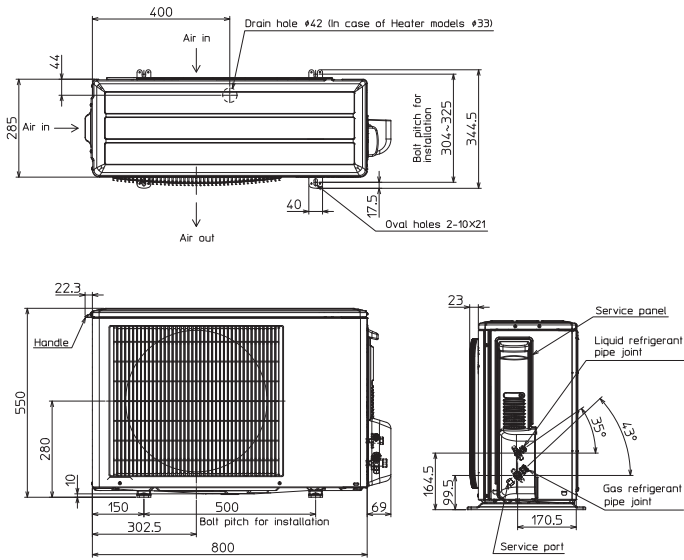

SUZ-M50VA

OUTDOOR UNIT

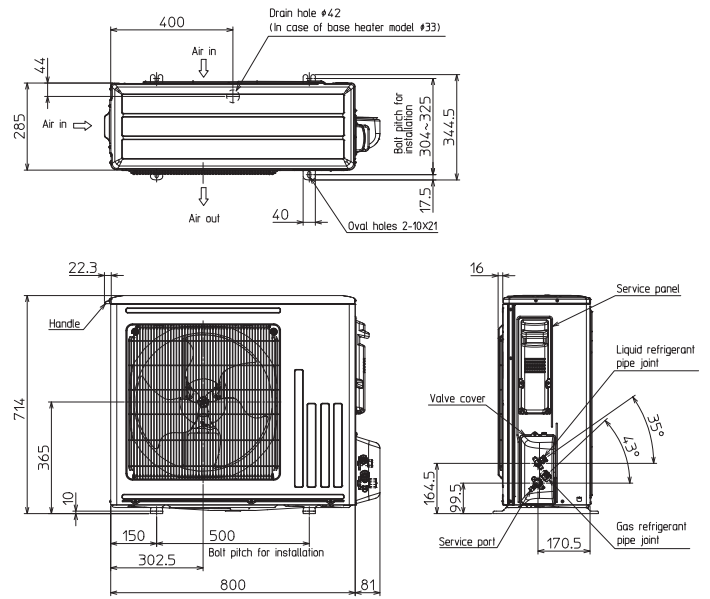

SUZ-M60VA SUZ-M71VA

INDOOR UNIT

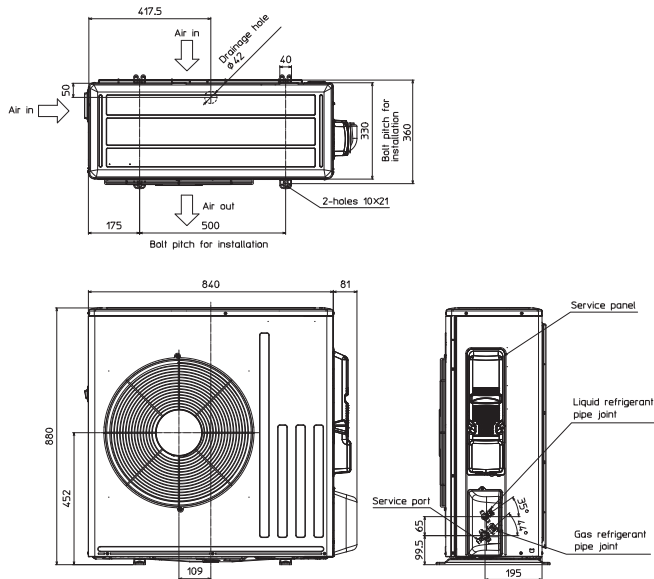

SUZ-KA25VA6 SUZ-KA35VA6

INDOOR UNIT

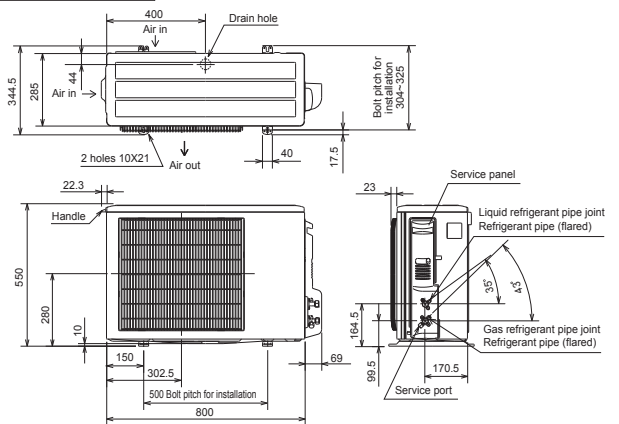

SUZ-KA50VA6 SUZ-KA60VA6 SUZ-KA71VA6

INDOOR UNIT

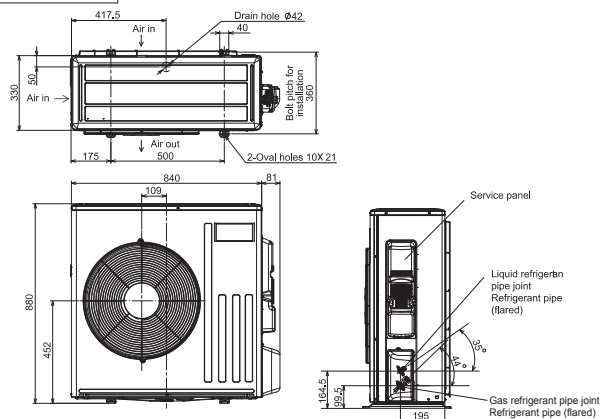

PLA-ZM35EA PLA-ZM50EA PLA-ZM60EA PLA-ZM71EA
 PLA-ZM100EA PLA-ZM125EA PLA-ZM140EA
 PLA-M35EA PLA-M50EA PLA-M60EA PLA-M71EA
 PLA-M100EA PLA-M125EA PLA-M140EA

INDOOR UNIT

PLA-ZM35EA/071/100/125/140EA
 PLA-M35EA/071/100/125/140EA

ZM	(1)	(2)	A	B	C	D	E	F
3550	REFRIGERANT PIPE #6.35 FLARED CONNECTION SIF	REFRIGERANT PIPE #12.7 FLARED CONNECTION SIF	241	258	76	76.5	265 OR MORE	3500 OR LESS
60	REFRIGERANT PIPE #6.35 FLARED CONNECTION SIF	REFRIGERANT PIPE #12.7 FLARED CONNECTION SIF	281	298	79.5	79.5	305 OR MORE	3500 OR LESS
71								
100-140								

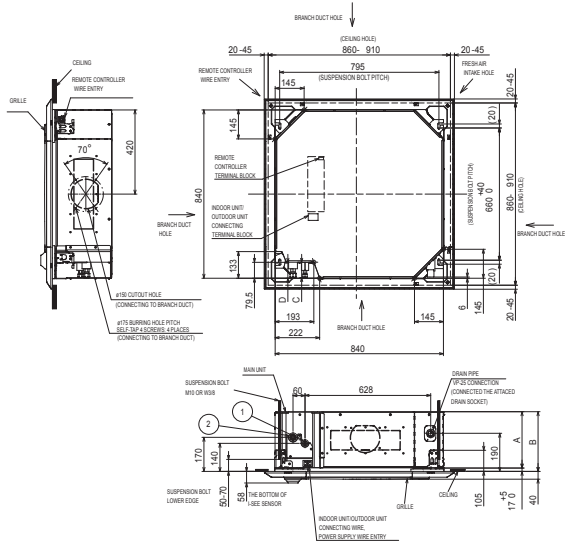
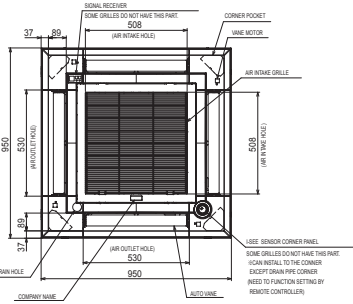

PKA-M35HA(L) PKA-M50HA(L)

INDOOR UNIT

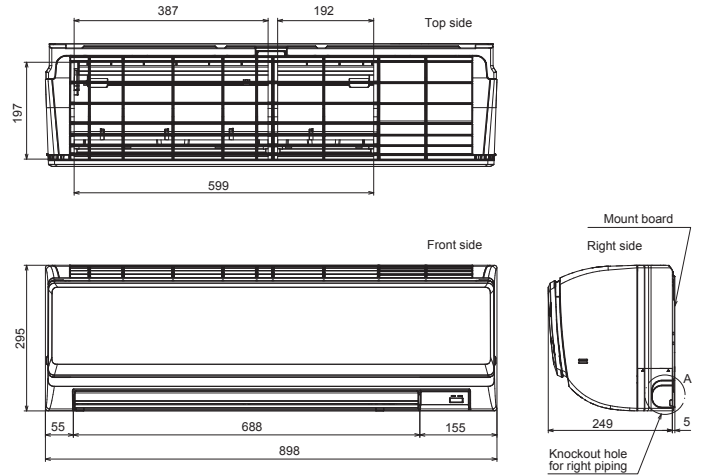

PKA-M60KA(L) PKA-M71KA(L) PKA-M100KA(L)

INDOOR UNIT

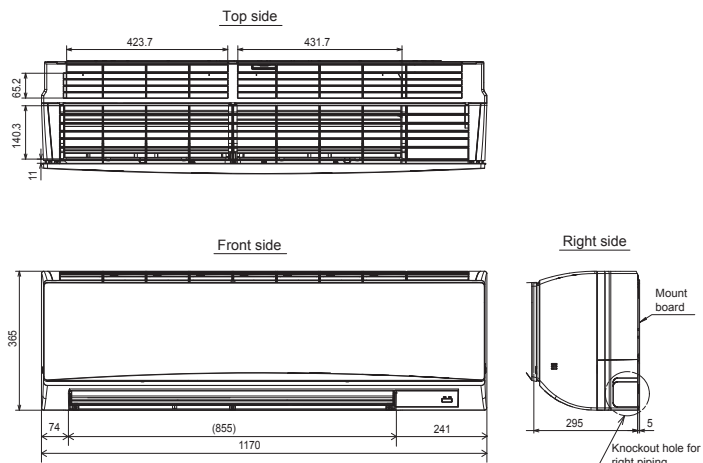

PCA-M35KA PCA-M50KA

INDOOR UNIT

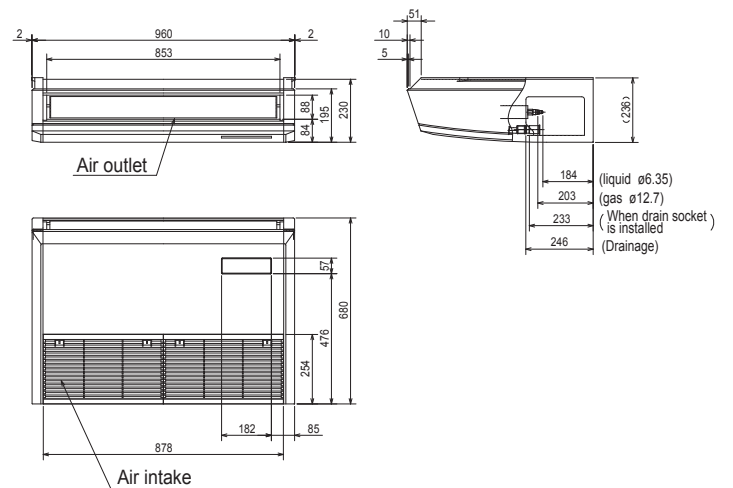

- NOTES.
 1. Use M10 or W/8 screw for anchor bolt.
 2. Please be sure when installing the drain pump (option parts), refrigerant pipe will be only upward.

PCA-M60KA PCA-M71KA

INDOOR UNIT

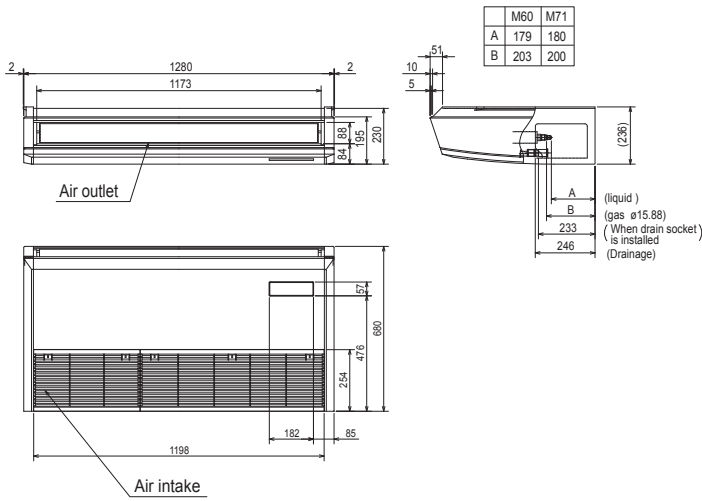

NOTES.

1. Use M10 or W3/8 screw for anchor bolt.
2. Please be sure when installing the drain pump (option parts), refrigerant pipe will be only upward.

Use the current nuts meeting the pipe size of the outdoor unit.
Available pipe size

PCA-M100KA PCA-M125KA PCA-M140KA

INDOOR UNIT

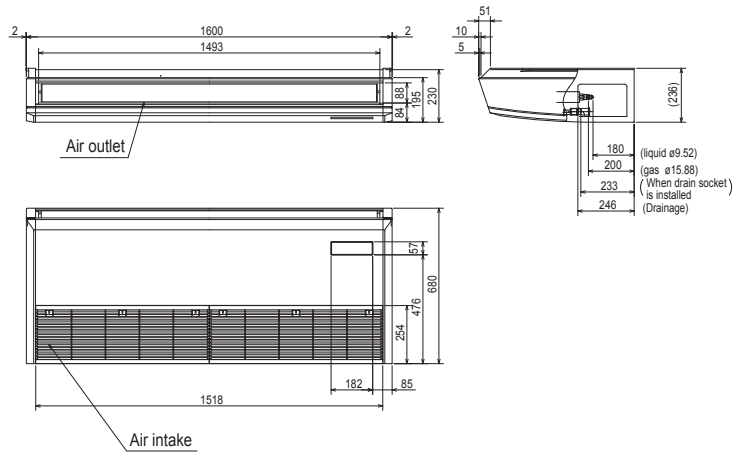

NOTES.

1. Use M10 or W3/8 screw for anchor bolt.
2. Please be sure when installing the drain pump (option parts), refrigerant pipe will be only upward.

PCA-RP71HAQ

INDOOR UNIT

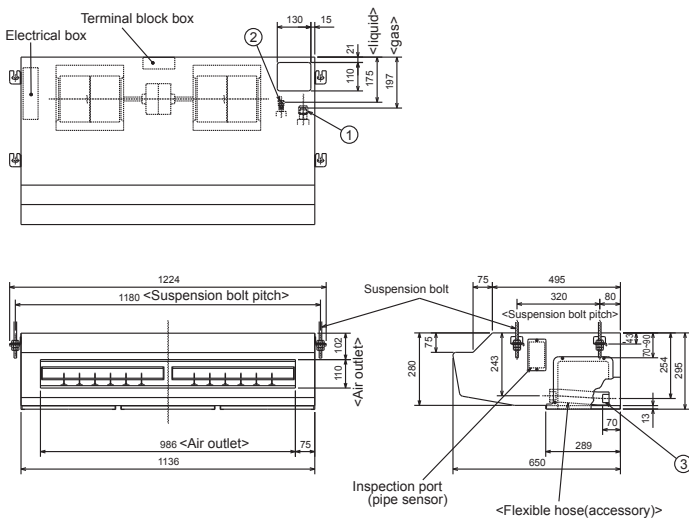

- ① Refrigerant pipe connection (gas pipe side/flared connection)
- ② Refrigerant pipe connection (liquid pipe side/flared connection)
- ③ Flexible hose (accessory) - Drainage pipe connection

PSA-RP71KA PSA-RP100KA PSA-RP125KA PSA-RP140KA

INDOOR UNIT

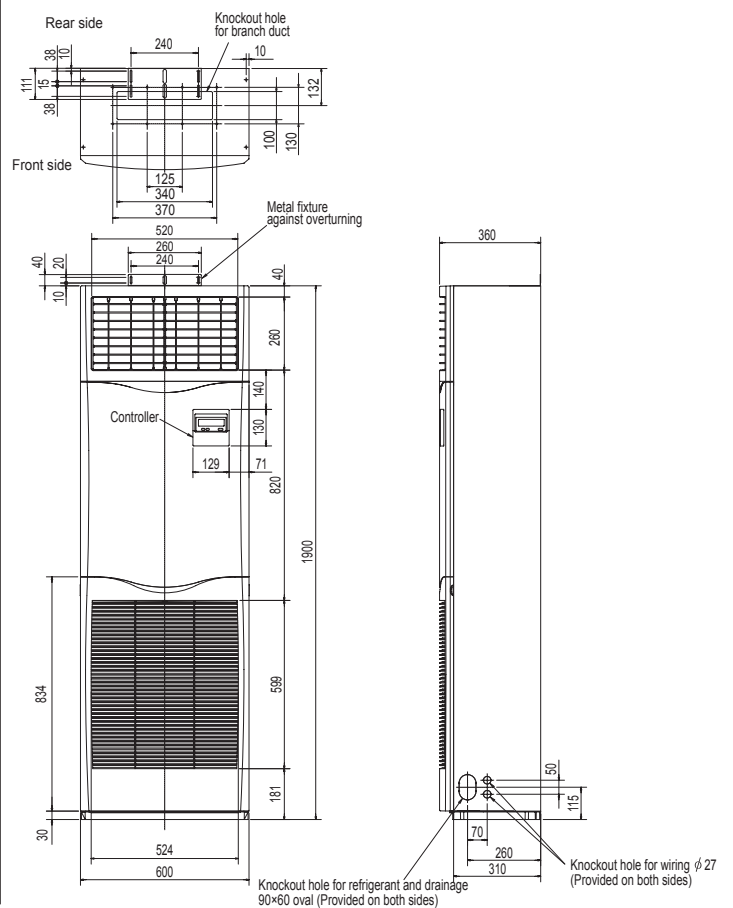

**PEAD-M35JA PEAD-M50JA PEAD-M60JA PEAD-M71JA
PEAD-M100JA PEAD-M125JA PEAD-M140JA**

INDOOR UNIT

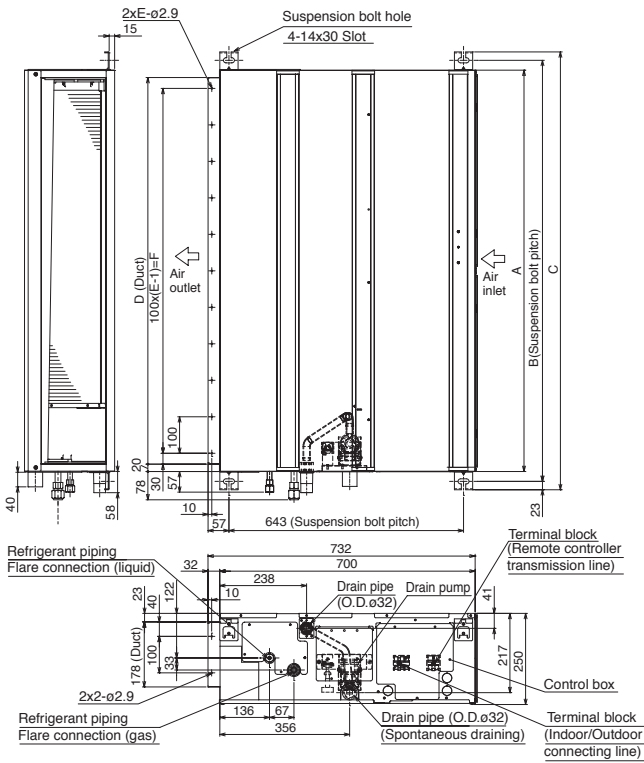

Model	A	B	C	D	E	F	G
PEAD-M35, 50JA	900	954	1000	860	9	800	858
PEAD-M60JA	1100	1154	1200	1060	11	1000	1058
PEAD-M71JA	1400	1454	1500	1360	14	1300	1358
PEAD-M100, 125JA	1600	1654	1700	1560	16	1500	1558

**PEAD-M35JAL PEAD-M50JAL PEAD-M60JAL
PEAD-M71JAL PEAD-M100JAL PEAD-M125JAL
PEAD-M140JAL**

INDOOR UNIT

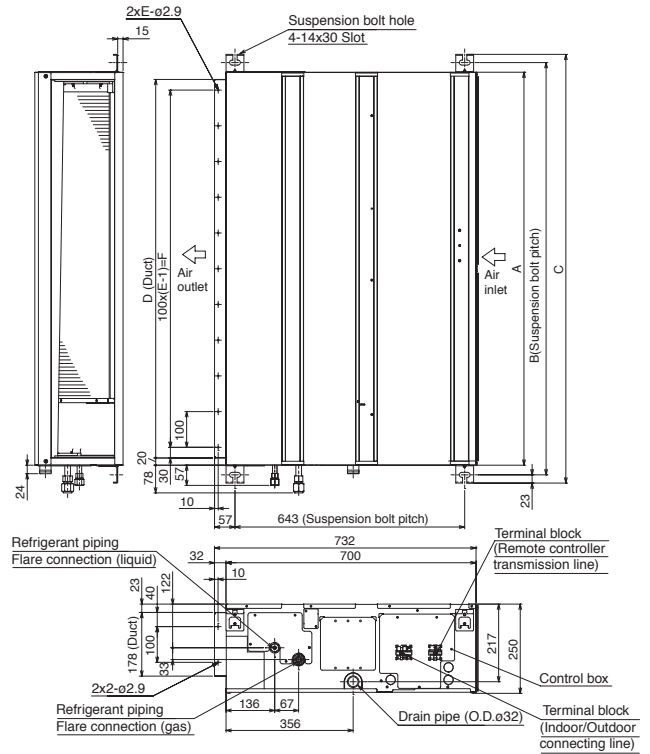

Model	A	B	C	D	E	F
PEAD-M35, 50JAL	900	954	1000	860	9	800
PEAD-M60JAL	1100	1154	1200	1060	11	1000
PEAD-M71JAL	1400	1454	1500	1360	14	1300
PEAD-M100, 125JAL	1600	1654	1700	1560	16	1500

PEA-RP200WKA PEA-RP250WKA

INDOOR UNIT

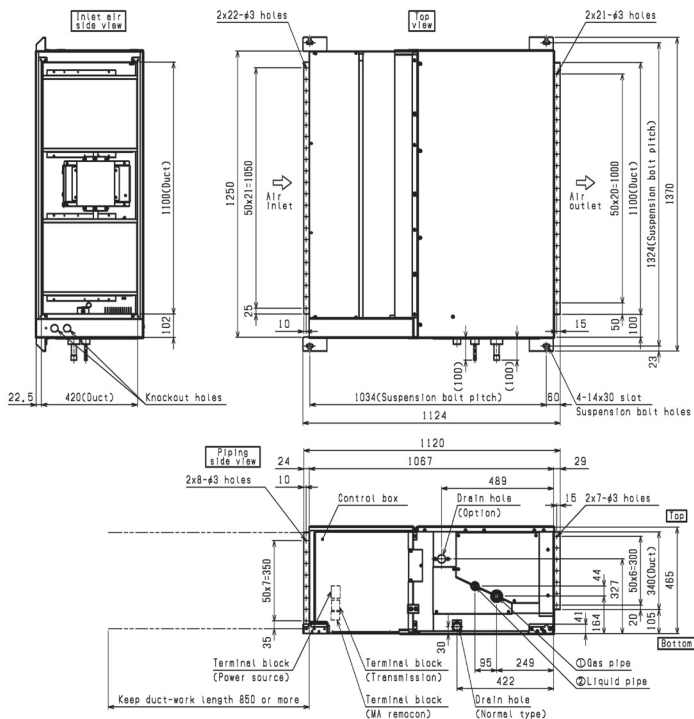

MODEL	Gas pipe	Liquid pipe	Drain hose
PEA-RP200WKA	φ25.4	φ9.52	Drain hose 32mm <flexible joint> <necessary>
PEA-RP250WKA	φ25.4	φ12.7	

**PUHZ-SHW112VHA PUHZ-SHW112YHA
PUHZ-SHW140YHA**

OUTDOOR UNIT

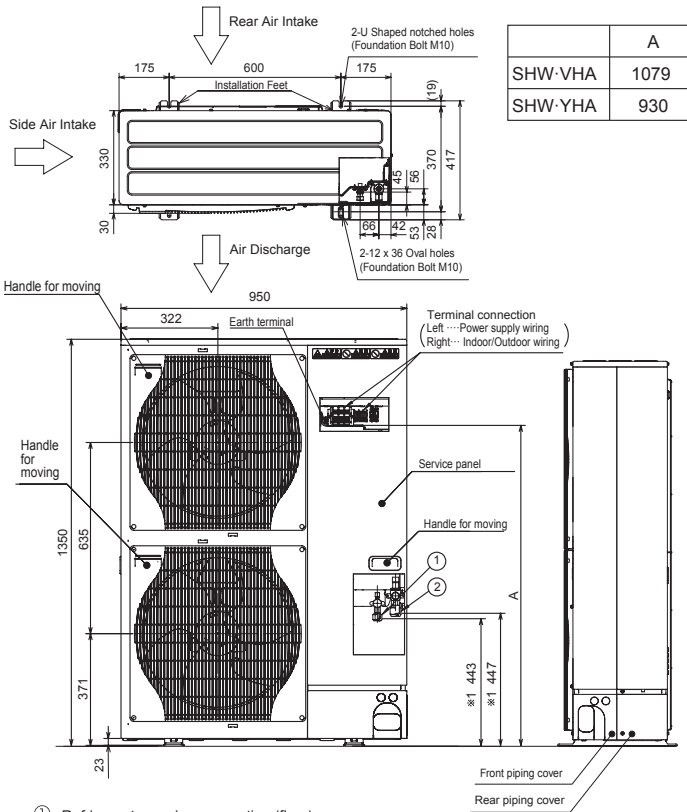

	A
SHW-VHA	1079
SHW-YHA	930

- ①...Refrigerant gas pipe connection (flare)
- ②...Refrigerant liquid pipe connection (flare)
- *...Indicates stop valve connection location.

PUZ-ZM35VKA PUZ-ZM50VKA

OUTDOOR UNIT

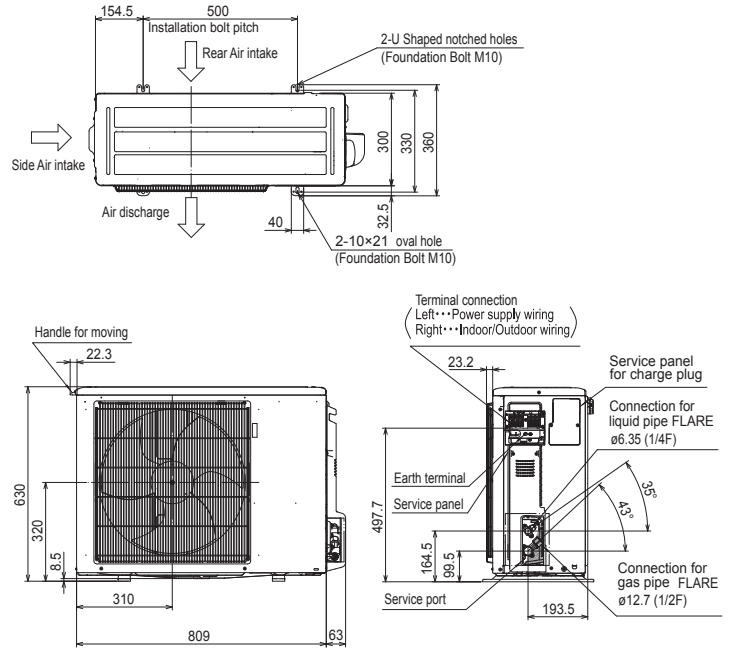

PUZ-ZM60VHA PUZ-ZM71VHA

OUTDOOR UNIT

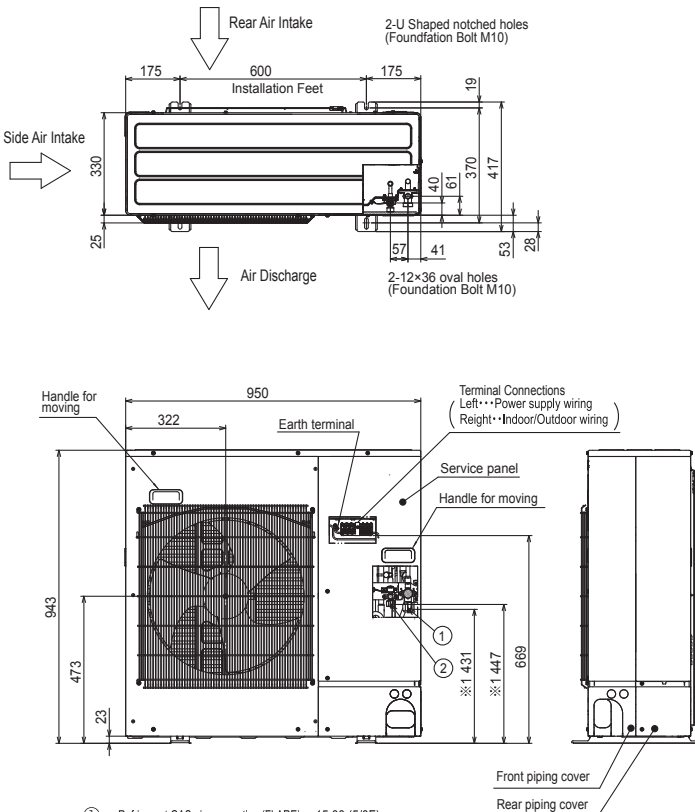

- ①...Refrigerant GAS pipe connection (FLARE) ø15.88 (5/8F)
- ②...Refrigerant LIQUID pipe connection (FLARE) ø9.52 (3/8F)
- *...Indication of STOP VALVE connection location.

**PUZ-ZM100VKA PUZ-ZM125VKA PUZ-ZM140VKA
PUZ-ZM100YKA PUZ-ZM125YKA PUZ-ZM140YKA**

OUTDOOR UNIT

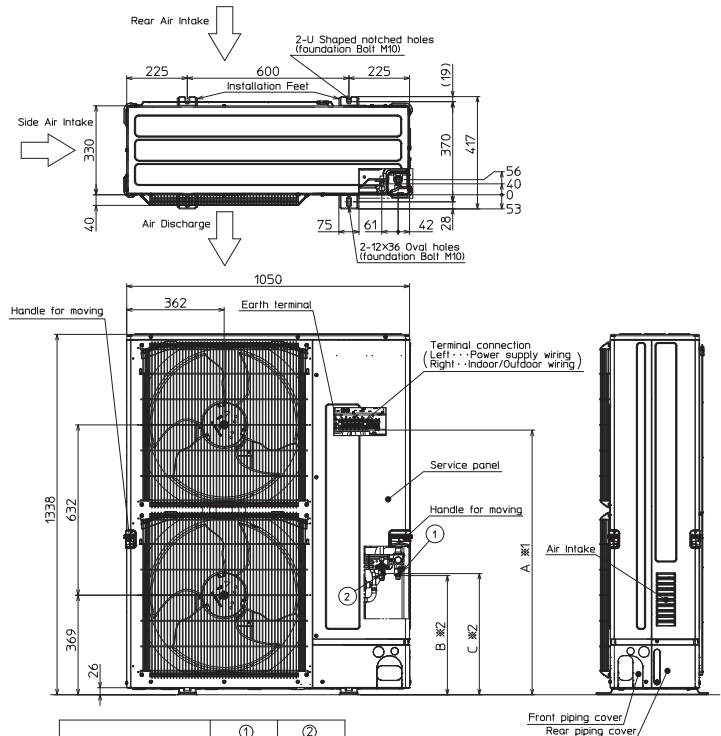

Model	① Refrigerant GAS pipe connection	② Refrigerant LIQUID pipe connection
PUZ-ZM100-140V/YKA/JK	ø15.88 (5/8F)	ø9.52 (3/8F)

Model	A	B	C
PUZ-ZM100-140VKA/JK	1067	442	450
PUZ-ZM100-140YKA/JK	919	442	450

*1...Indication of Terminal connection location.
*2...Indication of STOP VALVE connection location.

PUHZ-ZRP200YKA3 PUHZ-ZRP250YKA3

OUTDOOR UNIT

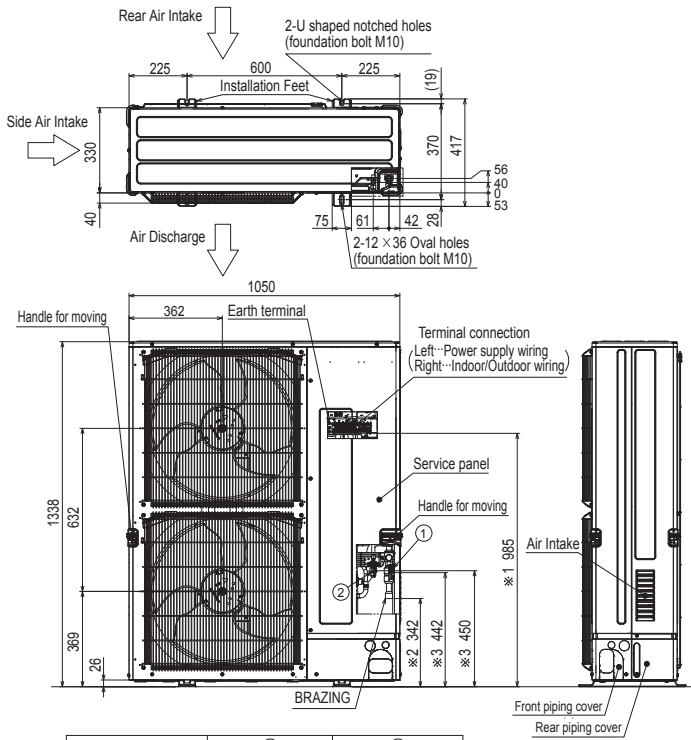

Model	① Refrigerant GAS pipe connection	② Refrigerant LIQUID pipe connection
PUHZ-ZRP200YKA3	ø19.05 (3/4F)	ø9.52 (3/8F)
PUHZ-ZRP250YKA3	ø19.05 (3/4F)	ø12.7 (1/2F)

- ※1--Indication of Terminal connection location.
- ※2--Refrigerant GAS pipe connection (BRAZING) O.Dø25.4.
- ※3--Indication of STOP VALVE connection location.

**PUZ-M100VKA PUZ-M100YKA
PUZ-M125VKA PUZ-M125YKA
PUZ-M140VKA PUZ-M140YKA**

OUTDOOR UNIT

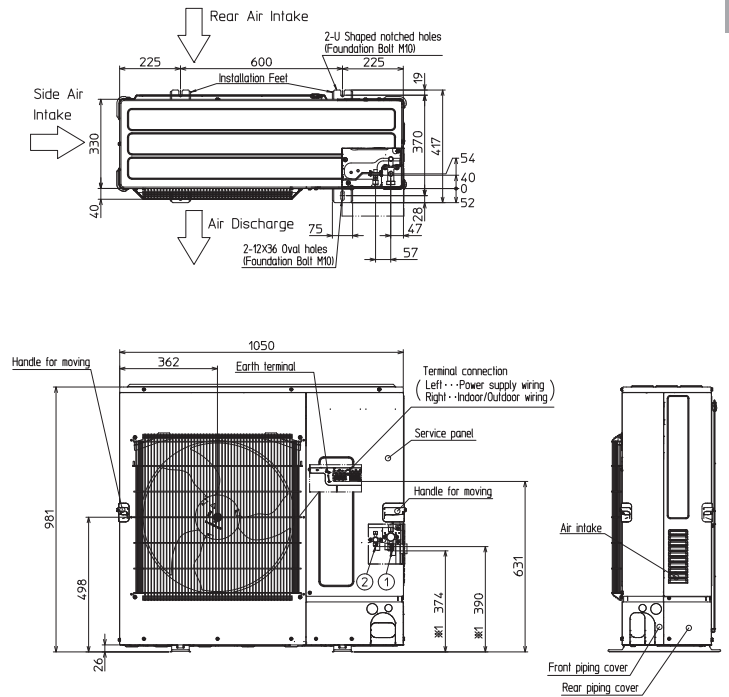

Example Of Notes

- ①...Refrigerant GAS pipe connection (FLARE) ø15.88(5/8F)
- ②...Refrigerant LIQUID pipe connection (FLARE) ø9.52(3/8F)
- ※1...Indication of STOP VALVE connection location.

**PUHZ-P100VKA PUHZ-P100YKA
PUHZ-P125VKA PUHZ-P125YKA
PUHZ-P140VKA PUHZ-P140YKA**

OUTDOOR UNIT

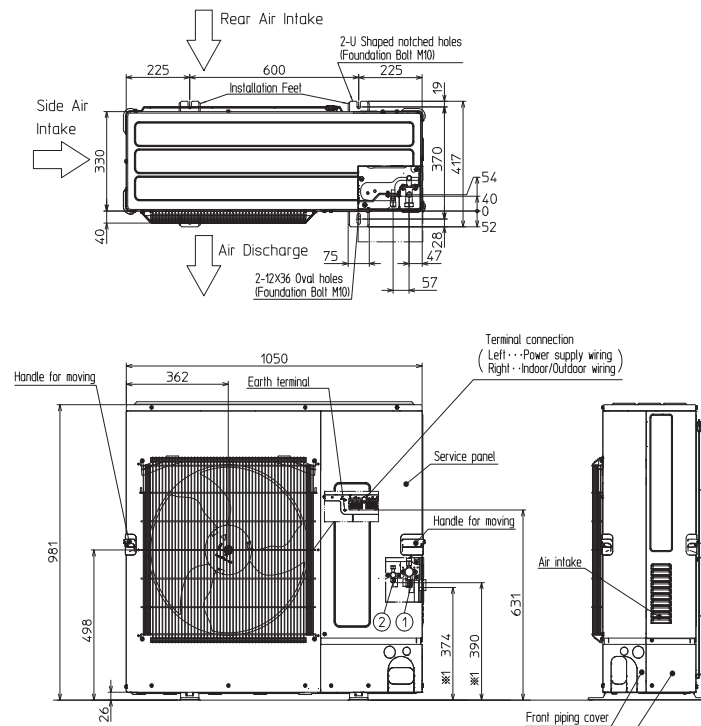

- ①...Refrigerant GAS pipe connection (FLARE) ø15.88(5/8F)
- ②...Refrigerant LIQUID pipe connection (FLARE) ø9.52(3/8F)
- ※1...Indication of STOP VALVE connection location.

PUHZ-P200YKA3 PUHZ-P250YKA3

OUTDOOR UNIT

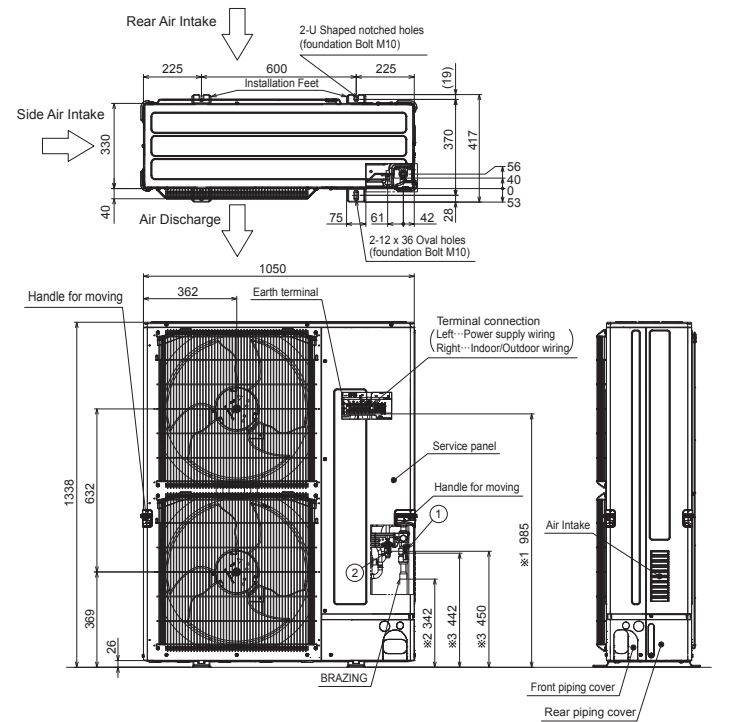

Model	① Refrigerant GAS pipe connection	② Refrigerant LIQUID pipe connection
PUHZ-P200YKA3	ø19.05 (3/4F)	ø9.52 (3/8F)
PUHZ-P250YKA3	ø19.05 (3/4F)	ø12.7 (1/2F)

- ※1--Indication of Terminal connection location.
- ※2--Refrigerant GAS pipe connection (BRAZING) O.Dø25.4.
- ※3--Indication of STOP VALVE connection location.

MXZ-2D33VA MXZ-2D42VA2 MXZ-2D53VA2 MXZ-2D53VAH2
MXZ-2DM40VA MXZ-2HA40VF MXZ-2HA50VF
MXZ-2F33VF MXZ-2F42VF MXZ-2F53VF MXZ-2F53VFH

OUTDOOR UNIT

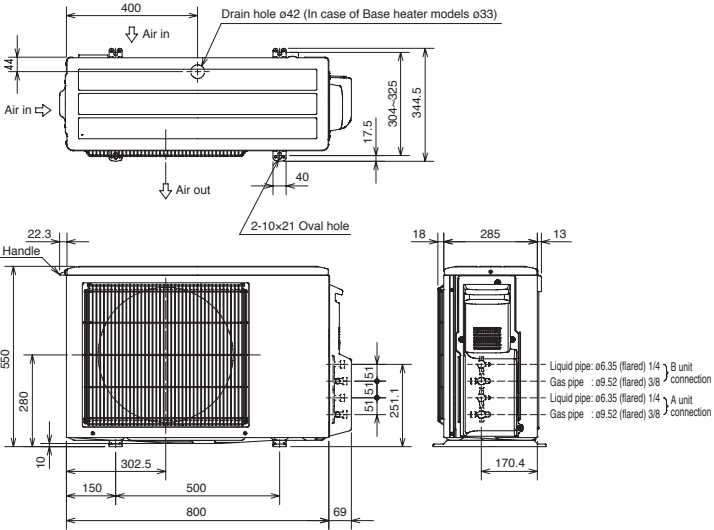

MXZ-2E53VAHZ

OUTDOOR UNIT

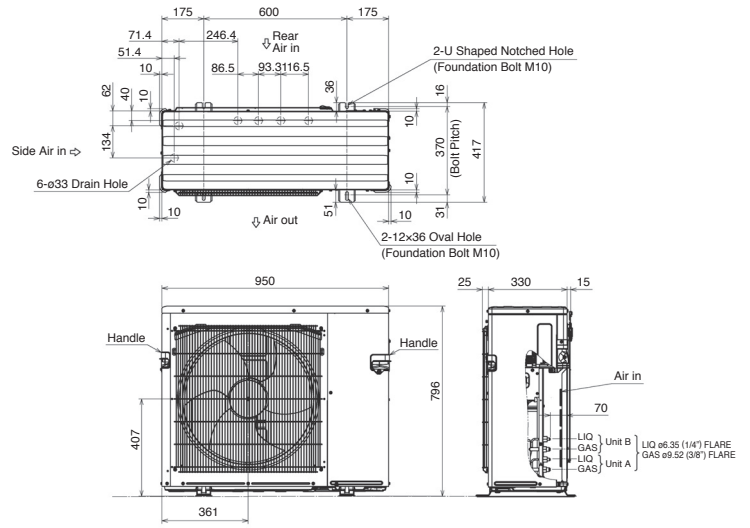

MXZ-3E54VA MXZ-3E68VA
MXZ-3DM50VA MXZ-3HA50VF
MXZ-3F54VF MXZ-3F68VF

OUTDOOR UNIT

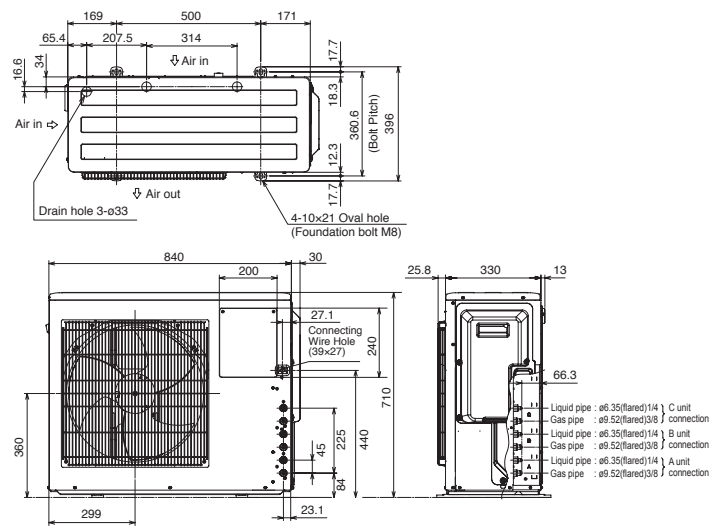

MXZ-4E72VA
MXZ-4F72VF

OUTDOOR UNIT

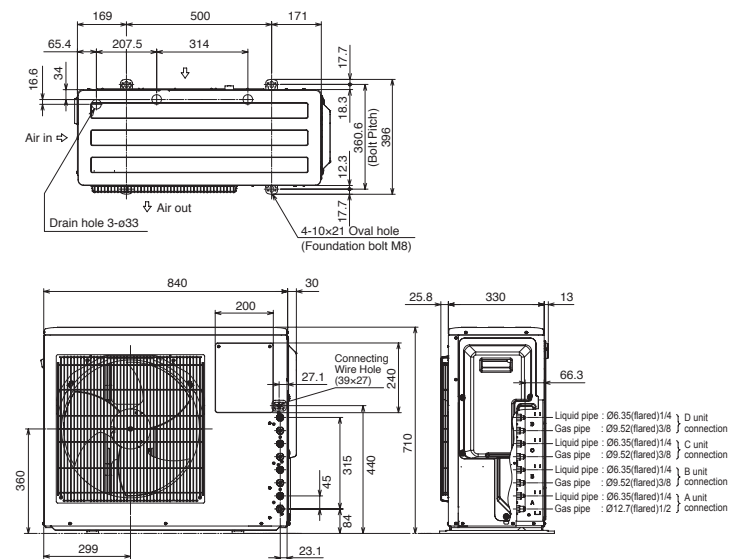

MXZ-4E83VA MXZ-5E102VA

OUTDOOR UNIT

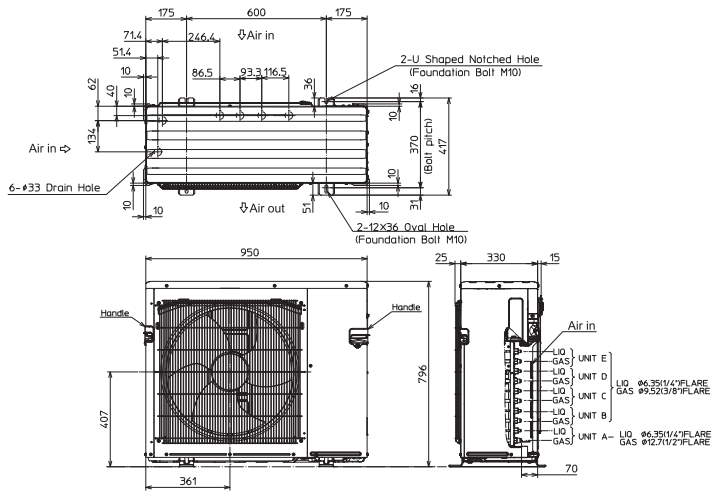

MXZ-4E83VAHZ

OUTDOOR UNIT

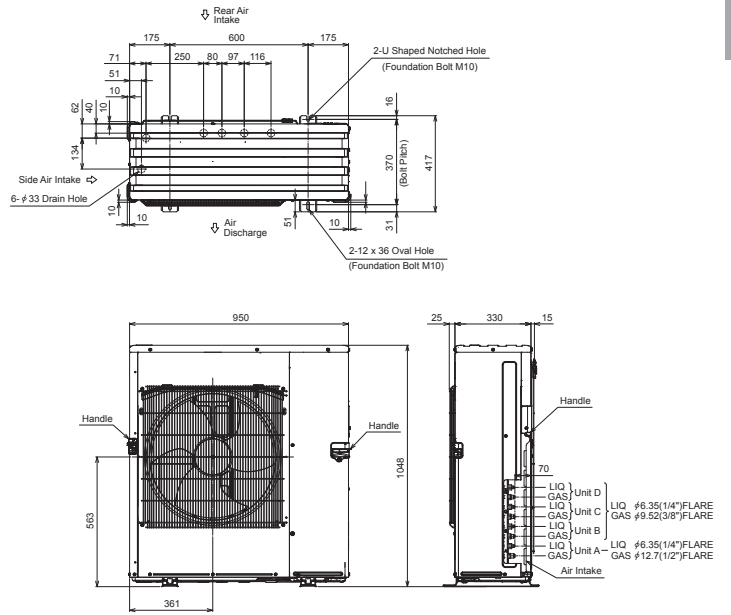

MXZ-6D122VA2

OUTDOOR UNIT

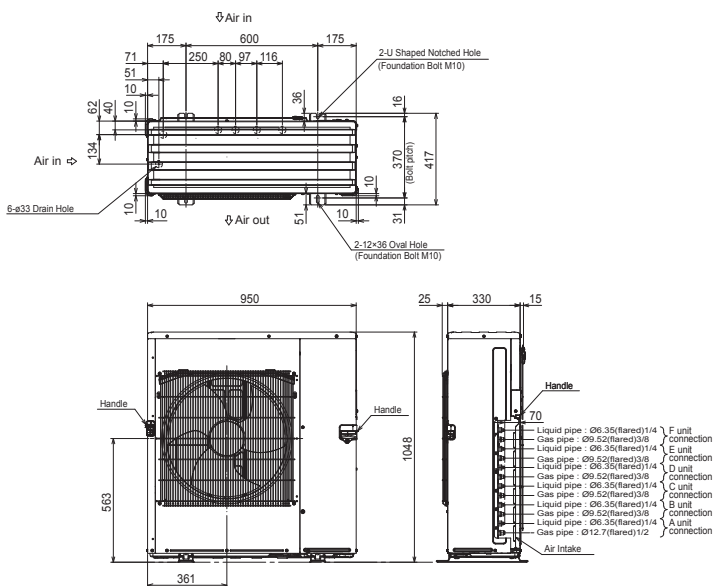

PUMY-P112/125/140VKM4(-BS)

OUTDOOR UNIT

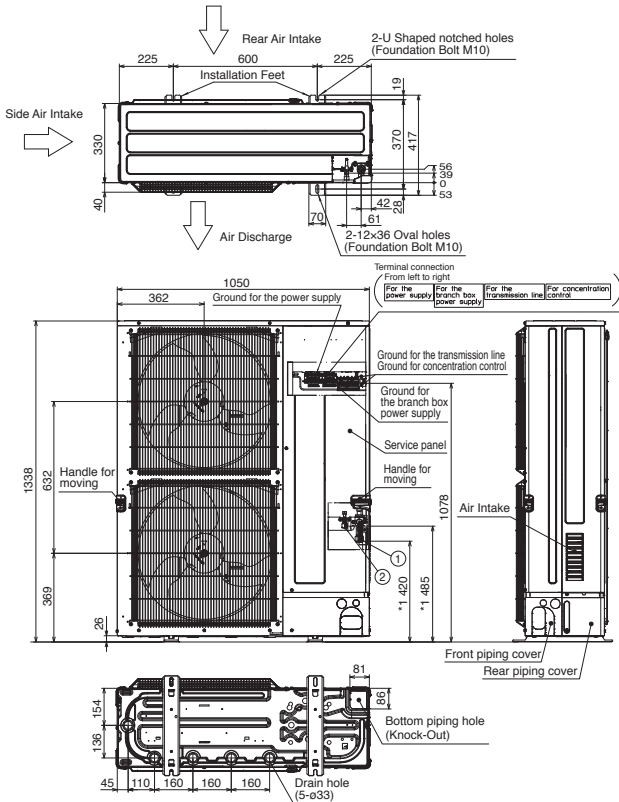

Example of Notes

- ① --- Refrigerant GAS pipe connection (FLARE) φ15.88 (5/8F)
- ② --- Refrigerant LIQUID pipe connection (FLARE) φ9.52 (3/8F)
- *1 --- Indication of STOP VALVE connection location.

PUMY-P112/125/140YKM(E)4(-BS)

OUTDOOR UNIT

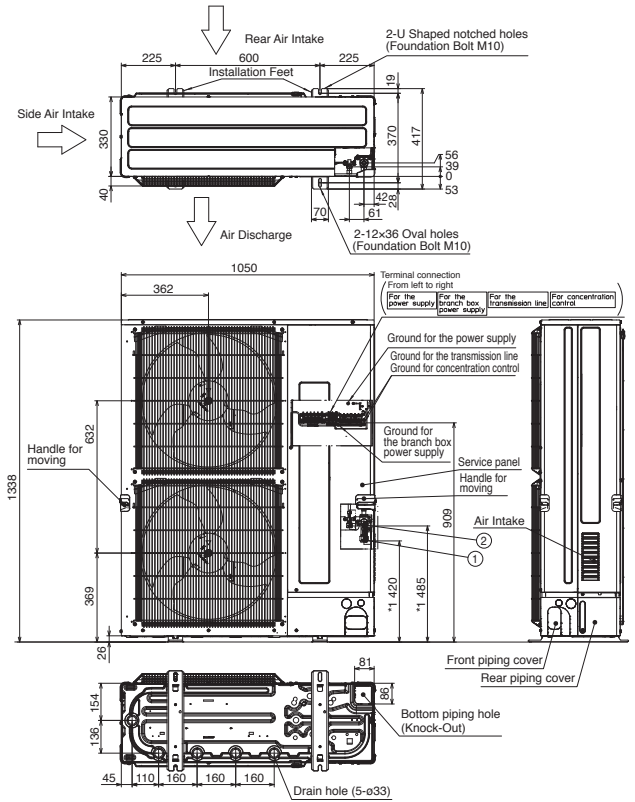

Example of Notes

- ① --- Refrigerant GAS pipe connection (FLARE) φ15.88 (5/8F)
- ② --- Refrigerant LIQUID pipe connection (FLARE) φ9.52 (3/8F)
- *1 --- Indication of STOP VALVE connection location.

PUMY-P200YKM2(-BS)

OUTDOOR UNIT

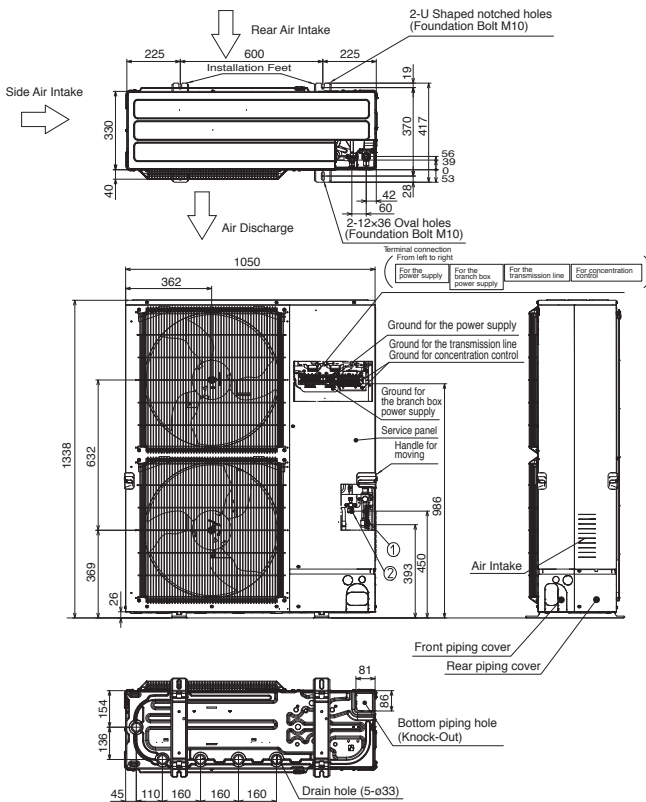

Example of Notes

- ① --- Refrigerant GAS pipe connection (FLARE) φ19.05 (3/4F)
- ② --- Refrigerant LIQUID pipe connection (FLARE) φ9.52 (3/8F)
- *1 --- Indication of STOP VALVE connection location.

PUMY-SP112/125/140VKM(-BS)
PUMY-SP112/125/140YKM(-BS)

OUTDOOR UNIT

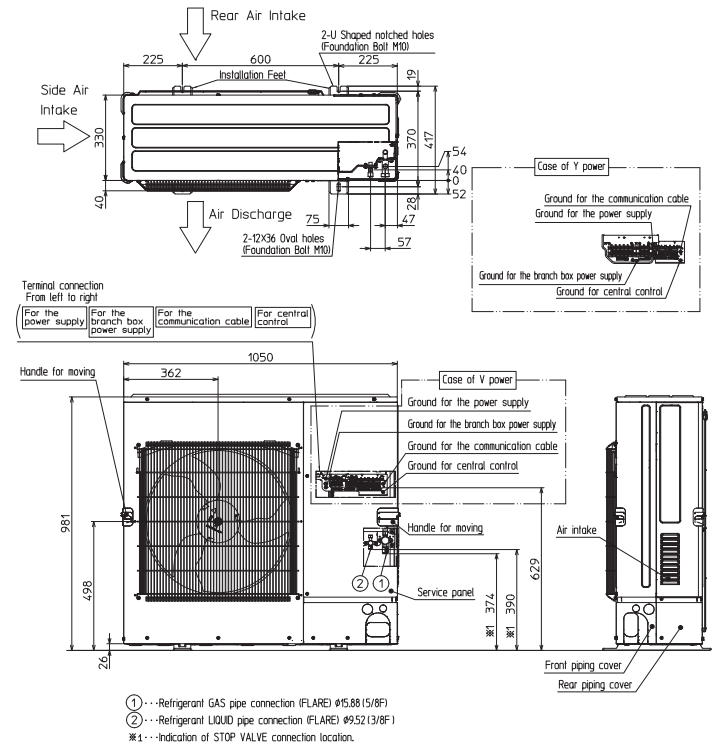

- ① --- Refrigerant GAS pipe connection (FLARE) φ15.88 (5/8F)
- ② --- Refrigerant LIQUID pipe connection (FLARE) φ9.52 (3/8F)
- *1 --- Indication of STOP VALVE connection location.

PAC-MK53BC

Suspension bolt: W3/W8 (M10)

Branch box

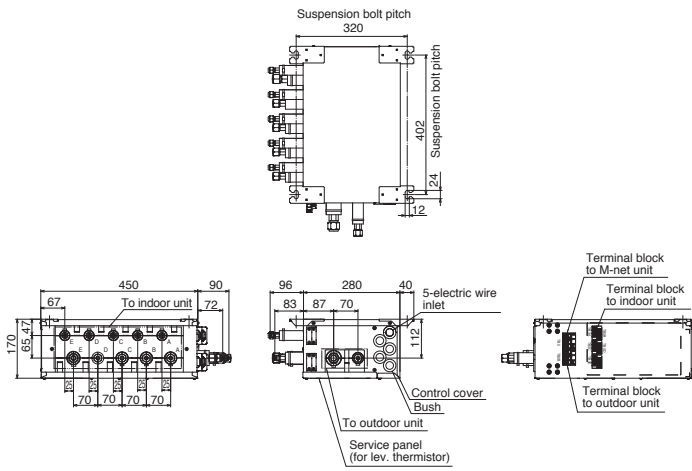

Suspension bolt : W3/8(M10)
Refrigerant pipe flared connection

	A	B	C	D	E	To outdoor unit
Liquid pipe	1/4F	1/4F	1/4F	1/4F	1/4F	3/8F
Gas pipe	3/8F	3/8F	3/8F	3/8F	1/2F	5/8F

PAC-MK33BC

Suspension bolt: W3/W8 (M10)

Branch box

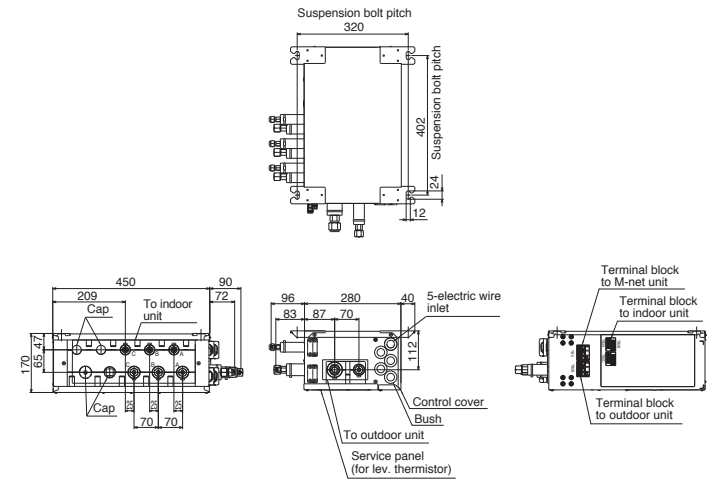

Suspension bolt : W3/8(M10)
Refrigerant pipe flared connection

	A	B	C	To outdoor unit
Liquid pipe	1/4F	1/4F	1/4F	3/8F
Gas pipe	3/8F	3/8F	3/8F	5/8F

PAC-MK53BCB

Suspension bolt: W3/W8 (M10)

Branch box

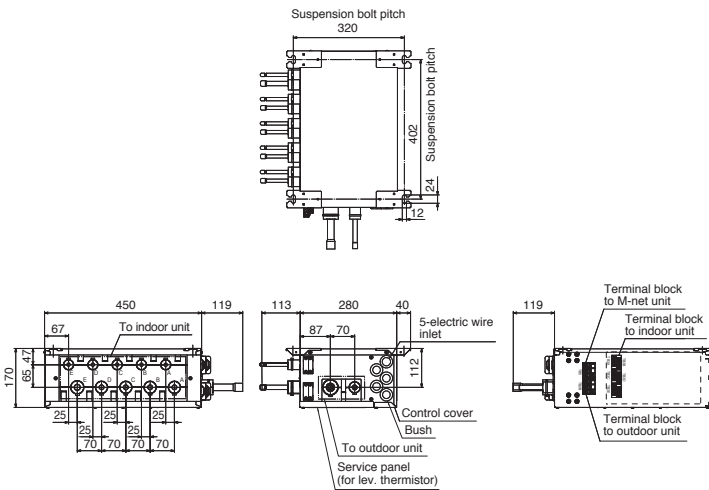

Suspension bolt : W3/8(M10)
Refrigerant pipe brazed connection

	A	B	C	D	E	To outdoor unit
Liquid pipe	ø6.35	ø6.35	ø6.35	ø6.35	ø6.35	ø9.52
Gas pipe	ø9.52	ø9.52	ø9.52	ø9.52	ø12.7	ø15.88

PAC-MK33BCB

Suspension bolt: W3/W8 (M10)

Branch box

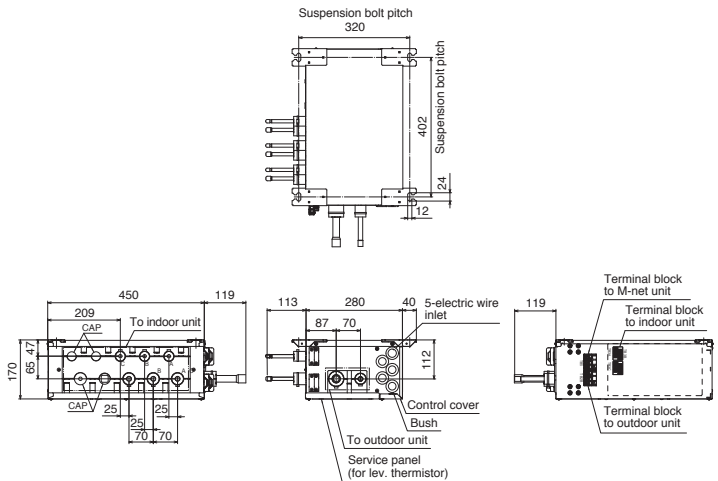

Suspension bolt : W3/8(M10)
Refrigerant pipe brazed connection

	A	B	C	To outdoor unit
Liquid pipe	ø6.35	ø6.35	ø6.35	ø9.52
Gas pipe	ø9.52	ø9.52	ø9.52	ø15.88

Piping Installation

M SERIES

Single type

Series	Class <Outdoor unit>	Maximum Piping Length (m)		Maximum Height Difference (m)		Maximum Number of Bends	
		Total length (A)	Indoor unit - Distribution pipe B	Outdoor unit - Indoor unit (H)	Indoor unit - Indoor unit h	Total number	Total number
MSZ-L	25 / 35	20	12	10			
	50	20	12	10			
	60	30	15	10			
MSZ-A	25 / 35 / 42	20	12	10			
	50	20					
MSZ-F MFZ	25 / 35	20	12	10			
	50	30	15	10			
MSZ-E	25 / 35 / 42	20	12	10			
	50	30	15	10			
MSZ-S	25 / 35 / 42	20	12	10			
	50	30	15	10			
MSZ-G	60 / 71	30	15	10			
MSZ-W MSZ-D	25 / 35	20	12	10			
MSY-TP	35 / 50	20	12	10			
MSZ-HJ	25 / 35 / 50	20	12	10			
	60 / 71	30	15	10			
MSZ-HR	25 / 35 / 42 / 50	20	12	10			

S SERIES & P SERIES

Single type

Series	Class <Outdoor unit>	Maximum Piping Length (m)		Maximum Height Difference (m)		Maximum Number of Bends	
		Total length (A)	Indoor unit - Distribution pipe B	Outdoor unit - Indoor unit (H)	Indoor unit - Indoor unit h	Total number	Total number
ZUBADAN (PUHZ-SHW)	80 / 112 / 140	75	30	15			
Power Inverter (PUZ-ZM)	35 / 50	50	30	15			
	60 / 71	55	30	15			
	100 / 125 / 140	100	30	15			
Power Inverter (PUHZ-ZRP)	35 / 50 / 60 / 71	50	30	15			
	100 / 125 / 140	75	30	15			
	200 / 250	100	30	15			
Standard Inverter (PUZ-M & SUZ-M)	25 / 35	20	12	10			
	50 / 60 / 71	30	30	10			
	100	55					
	125 / 140	65	30	15			
Standard Inverter (PUHZ-P & SUZ-KA)	25 / 35	20	12	10			
	50 / 60 / 71	30	30	10			
	100 / 125 / 140	50	30	15			
	200 / 250	70	30	15			

Twin type

Series	Class <Outdoor unit>	Maximum Piping Length (m)			Maximum Height Difference (m)		Maximum Number of Bends	
		Total length A+B+C	Pipe length difference from distribution pipe [B-C]	Indoor unit - Distribution pipe B	Outdoor unit - Indoor unit H	Indoor unit - Indoor unit h	Total number	Total number
ZUBADAN (PUHZ-SHW)	80 / 112 / 140	75	8	20	30	1	15	
Power Inverter (PUZ-ZM)	71	55	8	20	30	1	15	
	100 / 125 / 140	100	8	20	30	1	15	
Power Inverter (PUHZ-ZRP)	71	50	8	20	30	1	15	
	100 / 125 / 140	75	8	20	30	1	15	
	200 / 250	100	8	30	30	1	15	
Standard Inverter (PUZ-M)	100	55	8	20	30	1	15	
	125 / 140	65						
Standard Inverter (PUHZ-P)	100 / 125 / 140	50	8	20	30	1	15	
	200 / 250	70	8	30	30	1	15	

Triple type

Series	Class <Outdoor unit>	Maximum Piping Length (m)			Maximum Height Difference (m)		Maximum Number of Bends	
		Total length A+B+C+D	Pipe length difference from distribution pipe [B-C]	Indoor unit - Distribution pipe B	Outdoor unit - Indoor unit H	Indoor unit - Indoor unit h	Total number	Total number
Power Inverter (PUZ-ZM)	140	100	8	20	30	1	15	
Power Inverter (PUHZ-ZRP)	140	75	8	20	30	1	15	
	200 / 250	100	8	30	30	1	15	
Standard Inverter (PUZ-M)	140	65	8	20	30	1	15	
Standard Inverter (PUHZ-P)	140	50	8	20	30	1	15	
	200 / 250	70	8	28	30	1	15	

Quadruple type

Series	Class <Outdoor unit>	Maximum Piping Length (m)			Maximum Height Difference (m)		Maximum Number of Bends	
		Total length A+B+C+D+E	Pipe length difference from distribution pipe [B-C]	Indoor unit - Distribution pipe B	Outdoor unit - Indoor unit H	Indoor unit - Indoor unit h	Total number	Total number
Power Inverter (PUHZ-ZRP)	200 / 250	100	8	30	30	1	15	
Standard Inverter (PUHZ-P)	200 / 250	70	8	22	30	1	15	

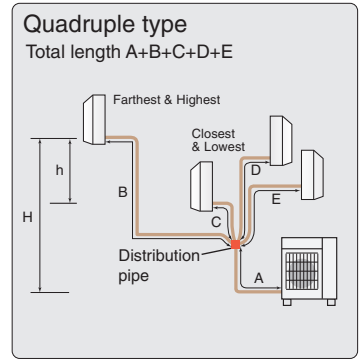
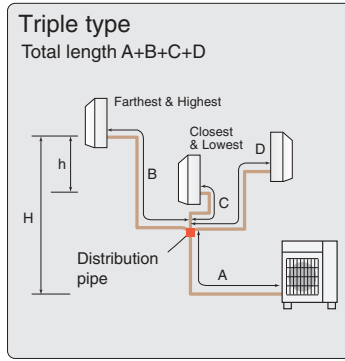
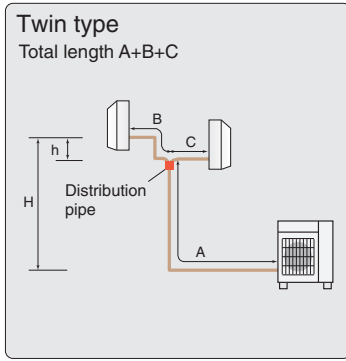
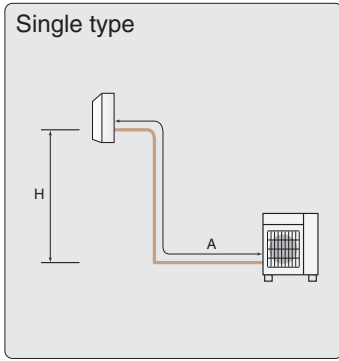

MXZ SERIES

MXZ-2D33VA, MXZ-2F33VF

Maximum Piping Length	
Outdoor unit - Indoor unit (a,b)	15m
Total length (a+b)	20m

Maximum Number of Bends	
Outdoor unit - Indoor unit (a,b)	15
Total number (a+b)	20

* When connecting MFZ-KJ Series indoor unit, additional refrigerant is required. For details, please contact Mitsubishi Electric.

Regarding MXZ-2D33, the second unit should be a different type in the case of selecting one MFZ-KJ.

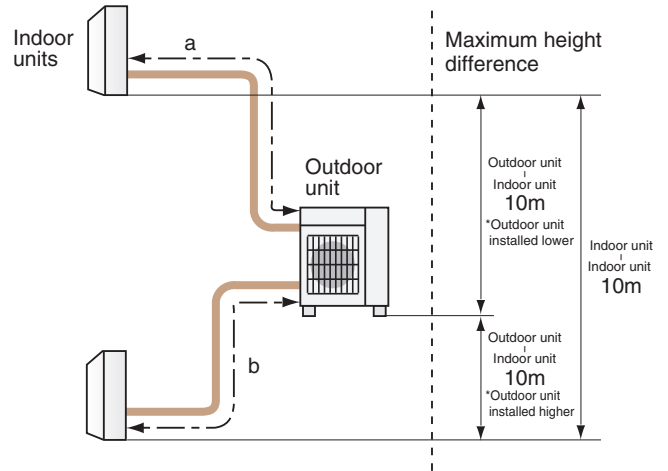

MXZ-2D42VA2, MXZ-2F42VF

Maximum Piping Length	
Outdoor unit - Indoor unit (a,b)	20m
Total length (a+b)	30m

Maximum Number of Bends	
Outdoor unit - Indoor unit (a,b)	20
Total number (a+b)	30

MXZ-2D53VA(H)2, MXZ-2E53VAHZ, MXZ-2F53VF(H)

Maximum Piping Length	
Outdoor unit - Indoor unit (a,b)	20m
Total length (a+b)	30m

Maximum Number of Bends	
Outdoor unit - Indoor unit (a,b)	20
Total number (a+b)	30

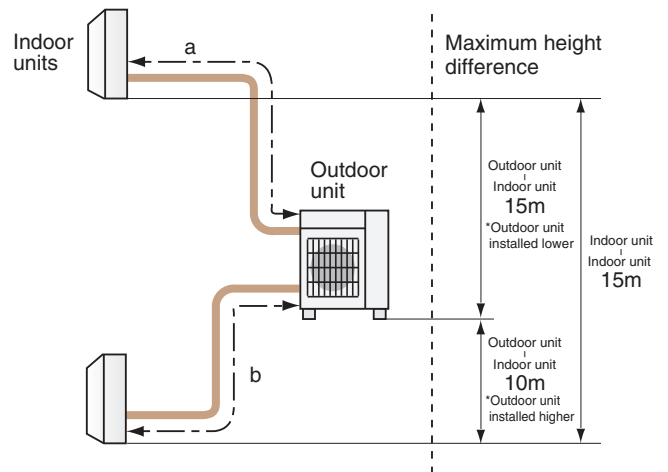

* When connecting MFZ-KJ Series indoor unit to MXZ-2D42VA2 or MXZ-2D53VA(H)2, additional refrigerant is required. For details, please contact Mitsubishi Electric.

MXZ SERIES

MXZ-2DM40VA

Maximum Piping Length	
Outdoor unit - Indoor unit (a,b)	20m
Total length (a+b)	30m

Maximum Number of Bends	
Outdoor unit - Indoor unit (a,b)	20
Total number (a+b)	30

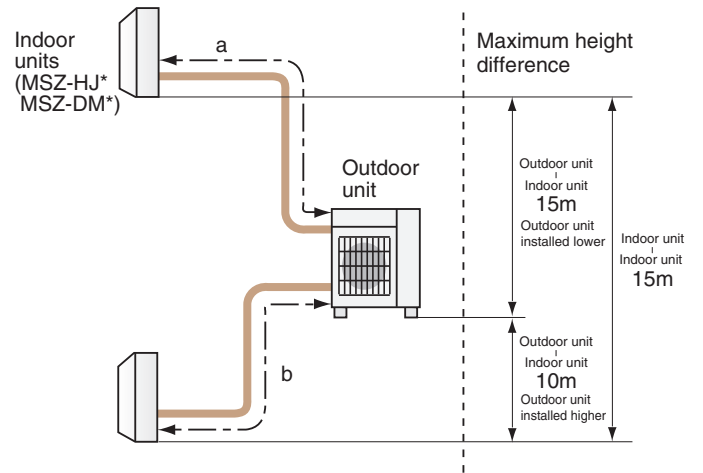

* Only MSZ-HJ and DM model is connectable.

MXZ-4E72VA, MXZ-4F72VF

Maximum Piping Length	
Outdoor unit - Indoor unit (a,b,c,d)	25m
Total length (a+b+c+d)	60m

Maximum Number of Bends	
Outdoor unit - Indoor unit (a,b,c,d)	25
Total number (a+b+c+d)	60

* When connecting MFZ-KJ Series indoor unit, additional refrigerant is required. For details, please contact Mitsubishi Electric.

MXZ-4E83VA, MXZ-4E83VAHZ

Maximum Piping Length	
Outdoor unit - Indoor unit (a,b,c,d)	25m
Total length (a+b+c+d)	70m

Maximum Number of Bends	
Outdoor unit - Indoor unit (a,b,c,d)	25
Total number (a+b+c+d)	70

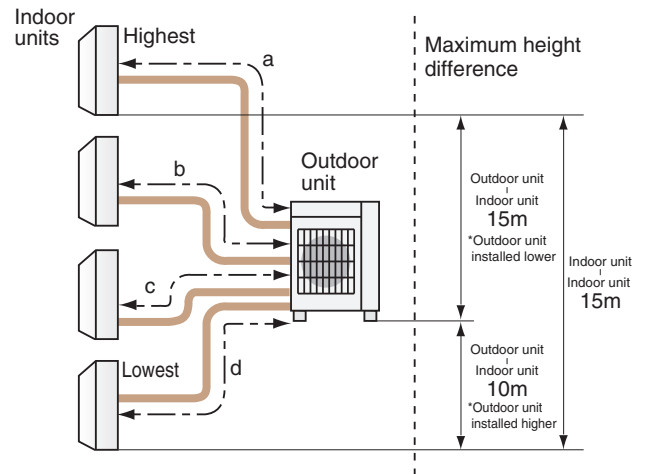

MXZ-5E102VA

Maximum Piping Length	
Outdoor unit - Indoor unit (a,b,c,d,e)	25m
Total length (a+b+c+d+e)	80m

Maximum Number of Bends	
Outdoor unit - Indoor unit (a,b,c,d,e)	25
Total number (a+b+c+d+e)	80

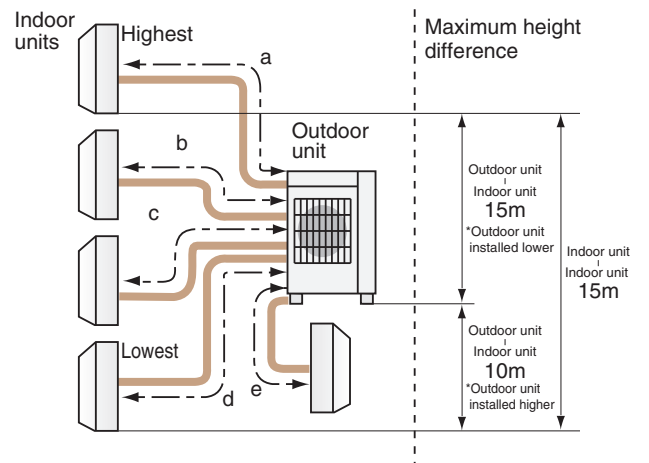

MXZ-6D122VA2

Maximum Piping Length	
Outdoor unit - Indoor unit (a,b,c,d,e,f)	25m
Total length (a+b+c+d+e+f)	80m

Maximum Number of Bends	
Outdoor unit - Indoor unit (a,b,c,d,e,f)	25
Total number (a+b+c+d+e+f)	80

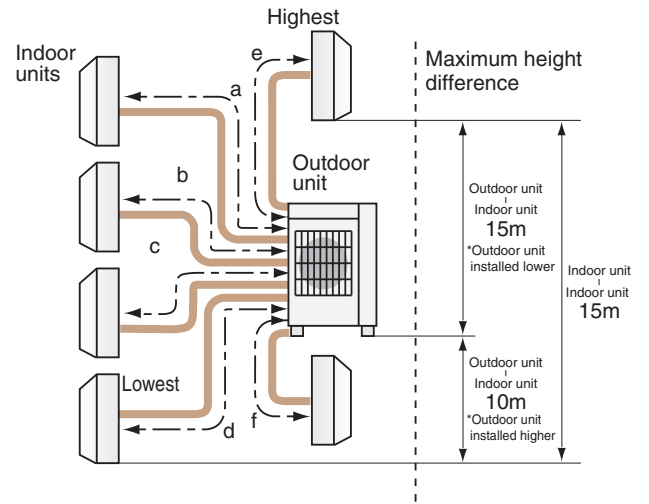

MXZ-2DM40VA, MXZ-2HA40VF, MXZ-2HA50VF

Maximum Piping Length	
Outdoor unit - Indoor unit (a,b)	20m
Total length (a+b)	30m

Maximum Number of Bends	
Outdoor unit - Indoor unit (a,b)	20
Total number (a+b)	30

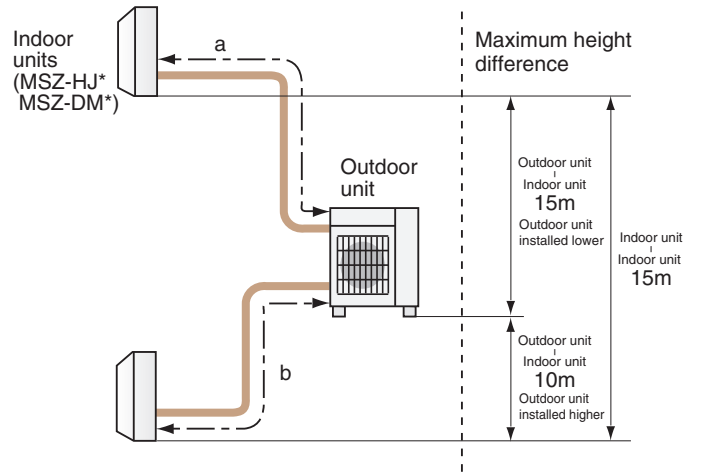

* Only MSZ-HJ and DM model is connectable.

MXZ-3DM50VA, MXZ-3HA50VF

Maximum Piping Length	
Outdoor unit - Indoor unit (a,b,c)	25m
Total length (a+b+c)	50m

Maximum Number of Bends	
Outdoor unit - Indoor unit (a,b,c)	25
Total number (a+b+c)	50

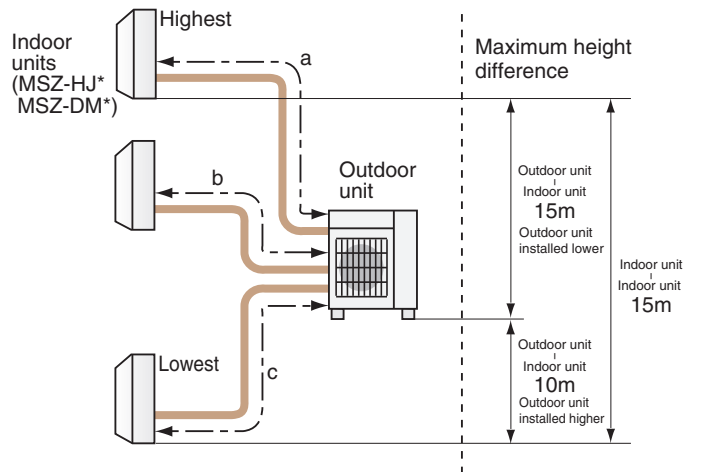

* Only MSZ-HJ and DM model is connectable.

PUMY SERIES

PUMY-SP112/125/140V(Y)KM

1-Branch box

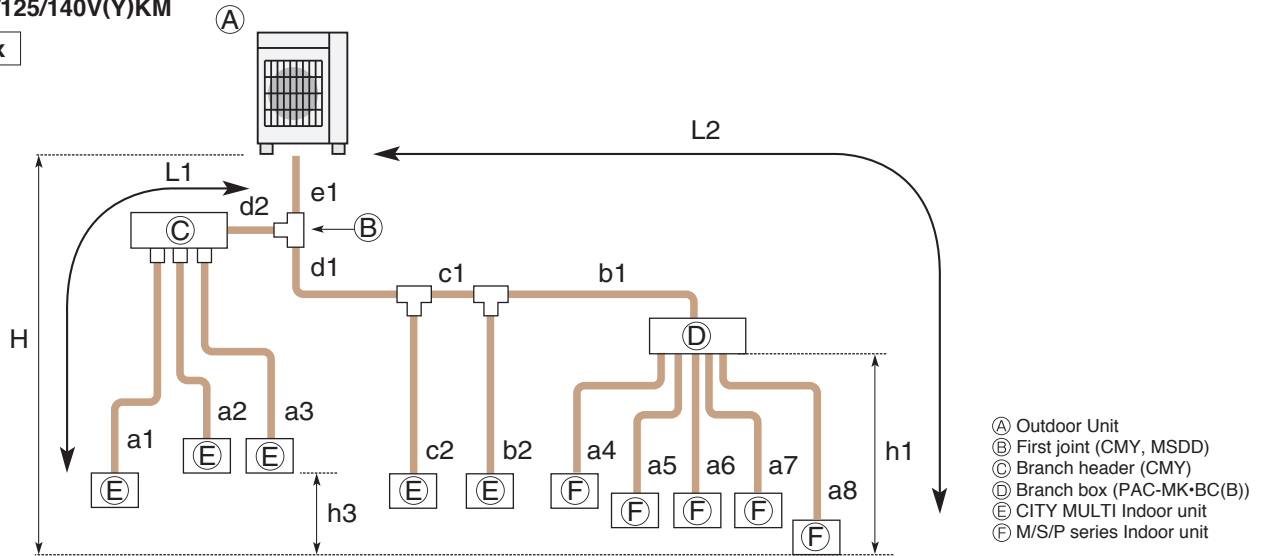

- Ⓐ Outdoor Unit
- Ⓑ First joint (CMY, MSDD)
- Ⓒ Branch header (CMY)
- Ⓓ Branch box (PAC-MK-BC(B))
- Ⓔ CITY MULTI Indoor unit
- Ⓕ M/S/P series Indoor unit

Permissible length (One-way)	Total piping length	$e1 + d1 + d2 + c1 + c2 + b1 + b2 + a1 + a2 + a3 + a4 + a5 + a6 + a7 + a8 \leq 120 \text{ m}$
	Farthest piping length (L1)	$e1 + d2 + a1$ or $e1 + d1 + c1 + b2 \leq 70 \text{ m}$
	Farthest piping length. Via Branch box (L2)	$e1 + d1 + c1 + b1 + a8 \leq 50 \text{ m}$
	Piping length between outdoor unit and branch box	$e1 + d1 + c1 + b1 \leq 55 \text{ m}$
	Farthest piping length from the first joint	$d1 + c1 + b1$ or $d1 + c1 + b2 \leq 50 \text{ m}$
	Farthest piping length after branch box	$a8 \leq 25 \text{ m}$
	Total piping length between branch boxes and indoor units	$a4 + a5 + a6 + a7 + a8 \leq 95 \text{ m}$
Permissible height difference (One-way)	In indoor/outdoor section (H)*1	$H \leq 50 \text{ m}$ (In case of outdoor unit is set higher than indoor unit) $H \leq 30 \text{ m}$ (In case of outdoor unit is set lower than indoor unit)
	In branch box/indoor unit section (h1)	$h1 \leq 15 \text{ m}$
	In each indoor unit (h3)	$h3 \leq 12 \text{ m}$
	Number of bends	$le1 + d2 + a1, le1 + d2 + a2, le1 + d2 + a3, le1 + d1 + c2, le1 + d1 + c1 + b2, le1 + d1 + c1 + b1 + a4, le1 + d1 + c1 + b1 + a5, le1 + d1 + c1 + b1 + a6, le1 + d1 + c1 + b1 + a7, le1 + d1 + c1 + b1 + a8 \leq 15$

*1: Branch box should be placed within the level between the outdoor unit and indoor units.

2-Branch boxes

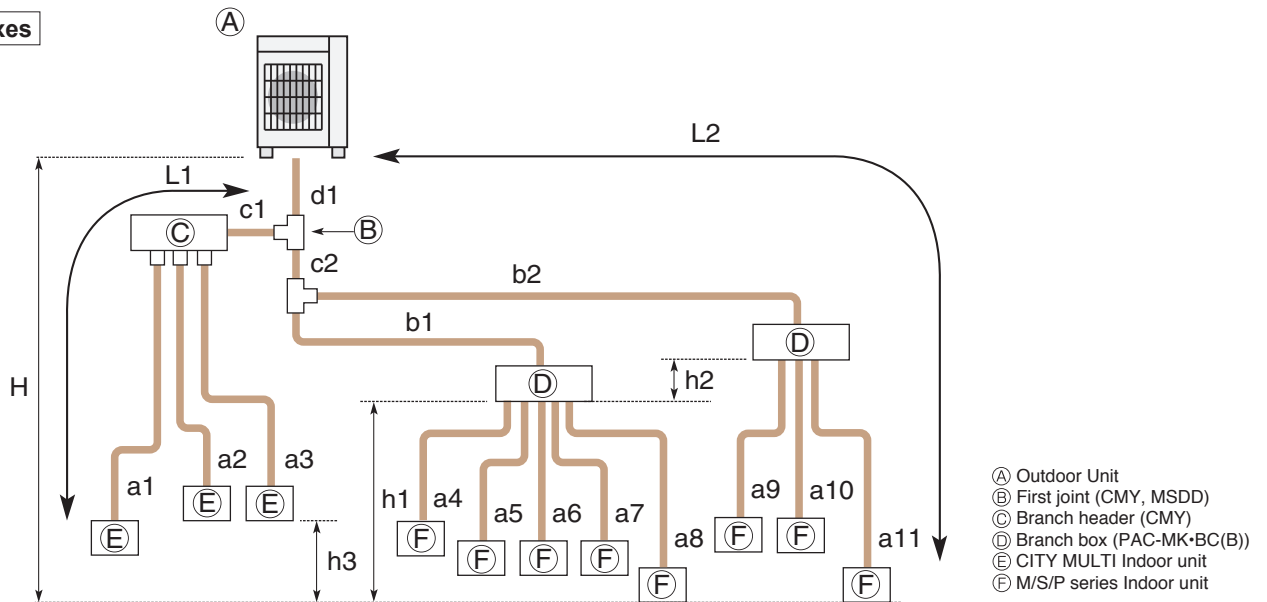

- Ⓐ Outdoor Unit
- Ⓑ First joint (CMY, MSDD)
- Ⓒ Branch header (CMY)
- Ⓓ Branch box (PAC-MK-BC(B))
- Ⓔ CITY MULTI Indoor unit
- Ⓕ M/S/P series Indoor unit

Permissible length (One-way)	Total piping length	$d1 + c1 + c2 + b1 + b2 + a1 + a2 + a3 + a4 + a5 + a6 + a7 + a8 + a9 + a10 + a11 \leq 120 \text{ m}$
	Farthest piping length (L1)	$d1 + c1 + a1 \leq 70 \text{ m}$
	Farthest piping length. Via Branch box (L2)	$d1 + c2 + b2 + a11 \leq 80 \text{ m}$
	Piping length between outdoor unit and branch boxes	$d1 + c2 + b1 + b2 \leq 55 \text{ m}$
	Farthest piping length from the first joint	$c2 + b2$ or $c1 + a1 \leq 50 \text{ m}$
	Farthest piping length after branch box	$a11 \leq 25 \text{ m}$
	Total piping length between branch boxes and indoor units	$a4 + a5 + a6 + a7 + a8 + a9 + a10 + a11 \leq 95 \text{ m}$
Permissible height difference (One-way)	In indoor/outdoor section (H)*1	$H \leq 50 \text{ m}$ (In case of outdoor unit is set higher than indoor unit) $H \leq 30 \text{ m}$ (In case of outdoor unit is set lower than indoor unit)
	In branch box/indoor unit section (h1)	$h1 + h2 \leq 15 \text{ m}$
	In each branch unit (h2)	$h2 \leq 15 \text{ m}$
	In each indoor unit (h3)	$h3 \leq 12 \text{ m}$
Number of bends	$ld1 + c1 + a1, ld1 + c1 + a2, ld1 + c1 + a3, ld1 + c2 + b1 + a4, ld1 + c2 + b1 + a5, ld1 + c2 + b1 + a6, ld1 + c2 + b1 + a7, ld1 + c2 + b1 + a8, ld1 + c2 + b2 + a9, ld1 + c2 + b2 + a10, ld1 + c2 + b2 + a11 \leq 15$	

*1: Branch box should be placed within the level between the outdoor unit and indoor units.

PUMY-P112/125/140V(Y)KM(E)4

1-Branch box

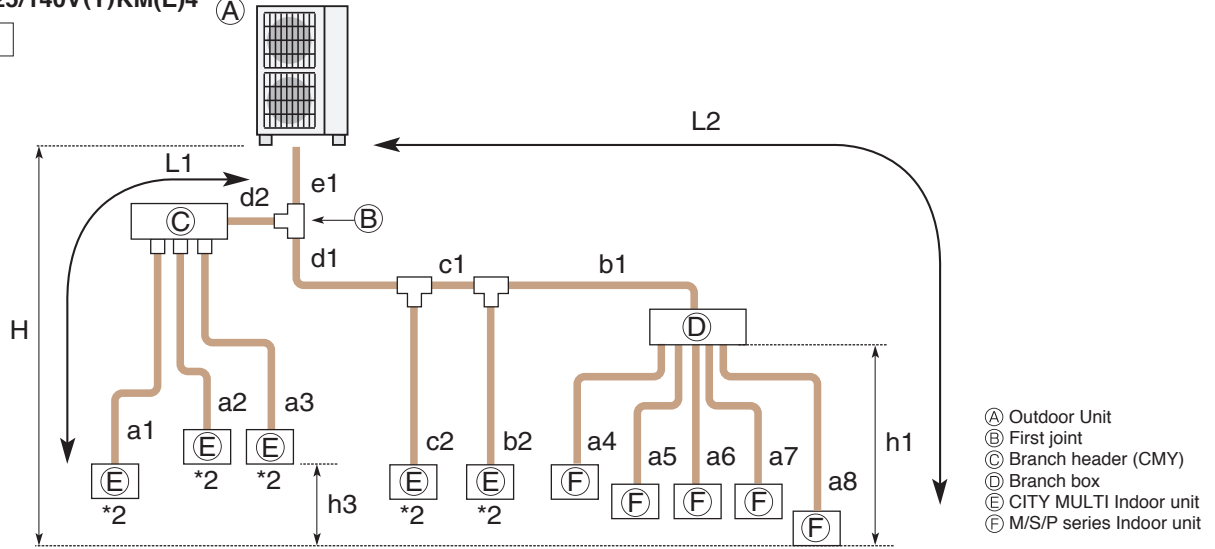

- Ⓐ Outdoor Unit
- Ⓑ First joint
- Ⓒ Branch header (CMY)
- Ⓓ Branch box
- Ⓔ CITY MULTI Indoor unit
- Ⓕ M/S/P series Indoor unit

Permissible length (One-way)	Total piping length	$e1 + d1 + d2 + c1 + c2 + b1 + b2 + a1 + a2 + a3 + a4 + a5 + a6 + a7 + a8 \leq 300 \text{ m}$
	Farthest piping length (L1)	$e1 + d2 + a1$ or $e1 + d1 + c1 + b2 \leq 85 \text{ m}$
	Farthest piping length. Via Branch box (L2)	$e1 + d1 + c1 + b1 + a8 \leq 80 \text{ m}$
	Piping length between outdoor unit and branch box	$e1 + d1 + c1 + b1 \leq 55 \text{ m}$
	Farthest piping length from the first joint	$d1 + c1 + b1$ or $d1 + c1 + b2 \leq 30 \text{ m}$
	Farthest piping length after branch box	$a8 \leq 25 \text{ m}$
	Total piping length between branch boxes and indoor units	$a4 + a5 + a6 + a7 + a8 \leq 95 \text{ m}$
Permissible height difference (One-way)	In indoor/outdoor section (H)*1	$H \leq 50 \text{ m}$ (In case of outdoor unit is set higher than indoor unit) $H \leq 40 \text{ m}$ (In case of outdoor unit is set lower than indoor unit)
	In branch box/indoor unit section (h1)	$h1 \leq 15 \text{ m}$
	In each indoor unit (h3)	$h3 \leq 12 \text{ m}$
Number of bends		$le1 + d2 + a1, le1 + d2 + a2l, le1 + d2 + a3l, le1 + d1 + c2l, le1 + d1 + c1 + b2l, le1 + d1 + c1 + b1 + a4l, le1 + d1 + c1 + b1 + a5l, le1 + d1 + c1 + b1 + a6l, le1 + d1 + c1 + b1 + a7l, le1 + d1 + c1 + b1 + a8l \leq 15$

*1: Branch box should be placed within the level between the outdoor unit and indoor units.

*2: PKFY and PFFY Series cannot be connected.

2-Branch boxes

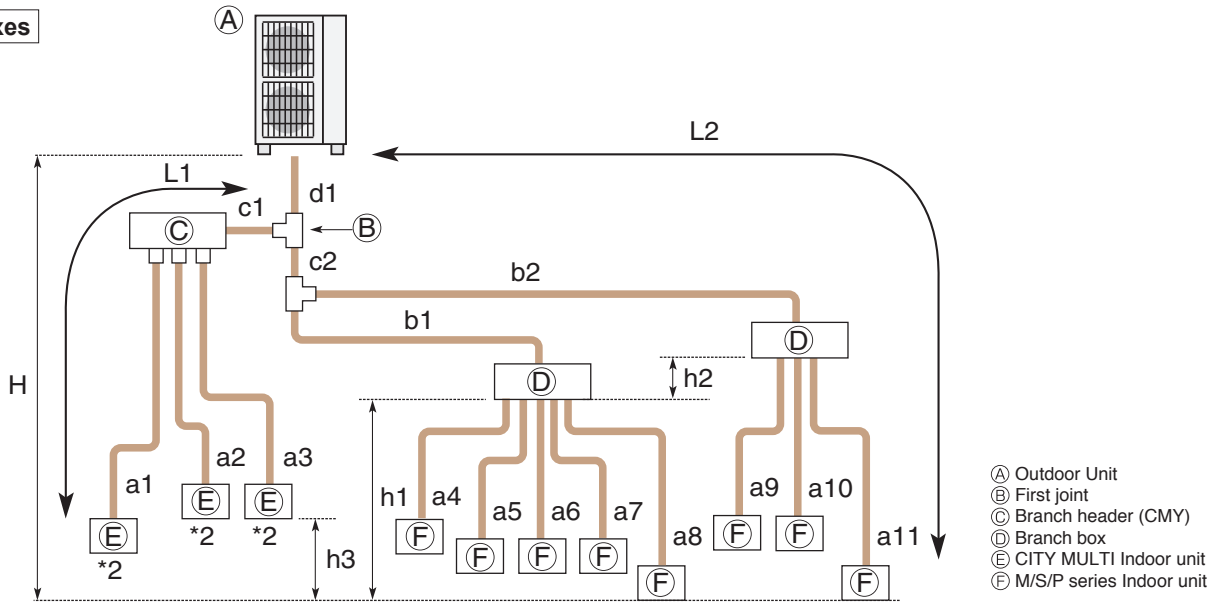

- Ⓐ Outdoor Unit
- Ⓑ First joint
- Ⓒ Branch header (CMY)
- Ⓓ Branch box
- Ⓔ CITY MULTI Indoor unit
- Ⓕ M/S/P series Indoor unit

Permissible length (One-way)	Total piping length	$d1 + c1 + c2 + b1 + b2 + a1 + a2 + a3 + a4 + a5 + a6 + a7 + a8 + a9 + a10 + a11 \leq 240 \text{ m}$
	Farthest piping length (L1)	$d1 + c1 + a1 \leq 85 \text{ m}$
	Farthest piping length. Via Branch box (L2)	$d1 + c2 + b2 + a11 \leq 80 \text{ m}$
	Piping length between outdoor unit and branch boxes	$d1 + c2 + b1 + b2 \leq 55 \text{ m}$
	Farthest piping length from the first joint	$c2 + b2$ or $c1 + a1 \leq 30 \text{ m}$
	Farthest piping length after branch box	$a11 \leq 25 \text{ m}$
	Total piping length between branch boxes and indoor units	$a4 + a5 + a6 + a7 + a8 + a9 + a10 + a11 \leq 95 \text{ m}$
Permissible height difference (One-way)	In indoor/outdoor section (H)*1	$H \leq 50 \text{ m}$ (In case of outdoor unit is set higher than indoor unit) $H \leq 40 \text{ m}$ (In case of outdoor unit is set lower than indoor unit)
	In branch box/indoor unit section (h1)	$h1 + h2 \leq 15 \text{ m}$
	In each branch unit (h2)	$h2 \leq 15 \text{ m}$
	In each indoor unit (h3)	$h3 \leq 12 \text{ m}$
Number of bends		$ld1 + c1 + a1, ld1 + c1 + a2l, ld1 + c1 + a3l, ld1 + c2 + b1 + a4l, ld1 + c2 + b1 + a5l, ld1 + c2 + b1 + a6l, ld1 + c2 + b1 + a7l, ld1 + c2 + b1 + a8l, ld1 + c2 + b2 + a9l, ld1 + c2 + b2 + a10l, ld1 + c2 + b2 + a11l \leq 15$

*1: Branch box should be placed within the level between the outdoor unit and indoor units.

*2: PKFY and PFFY Series cannot be connected.

PUMY-P200YKM2(-BS)

1-Branch box

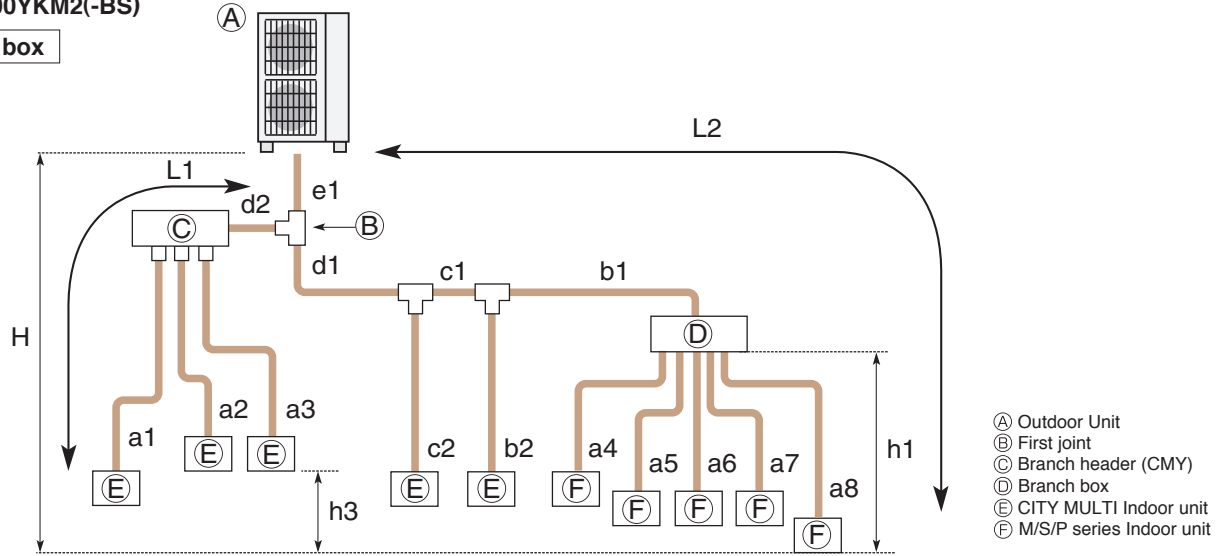

- Ⓐ Outdoor Unit
- Ⓑ First joint
- Ⓒ Branch header (CMY)
- Ⓓ Branch box
- Ⓔ CITY MULTI Indoor unit
- Ⓕ M/S/P series Indoor unit

Permissible length (One-way)	Total piping length	$e1 + d1 + d2 + c1 + c2 + b1 + b2 + a1 + a2 + a3 + a4 + a5 + a6 + a7 + a8 \leq 150 \text{ m}$
	Farthest piping length (L1)	$e1 + d2 + a1 \text{ or } e1 + d1 + c1 + b2 \leq 80 \text{ m}$
	Farthest piping length. Via Branch box (L2)	$e1 + d1 + c1 + b1 + a8 \leq 80 \text{ m}$
	Piping length between outdoor unit and branch box	$e1 + d1 + c1 + b1 \leq 55 \text{ m}$
	Farthest piping length from the first joint	$d1 + c1 + b1 \text{ or } d1 + c1 + b2 \leq 30 \text{ m}$
	Farthest piping length after branch box	$a8 \leq 25 \text{ m}$
	Total piping length between branch boxes and indoor units	$a4 + a5 + a6 + a7 + a8 \leq 95 \text{ m}$
Permissible height difference (One-way)	In indoor/outdoor section (H)*1	$H \leq 50 \text{ m}$ (In case of outdoor unit is set higher than indoor unit) $H \leq 40 \text{ m}$ (In case of outdoor unit is set lower than indoor unit)
	In branch box/indoor unit section (h1)	$h1 \leq 15 \text{ m}$
	In each indoor unit (h3)	$h3 \leq 12 \text{ m}$
Number of bends		$le1 + d2 + a1, le1 + d2 + a2, le1 + d2 + a3, le1 + d1 + c2, le1 + d1 + c1 + b2, le1 + d1 + c1 + b1 + a4, le1 + d1 + c1 + b1 + a5, le1 + d1 + c1 + b1 + a6, le1 + d1 + c1 + b1 + a7, le1 + d1 + c1 + b1 + a8 \leq 15$

*1: Branch box should be placed within the level between the outdoor unit and indoor units.

2-Branch boxes

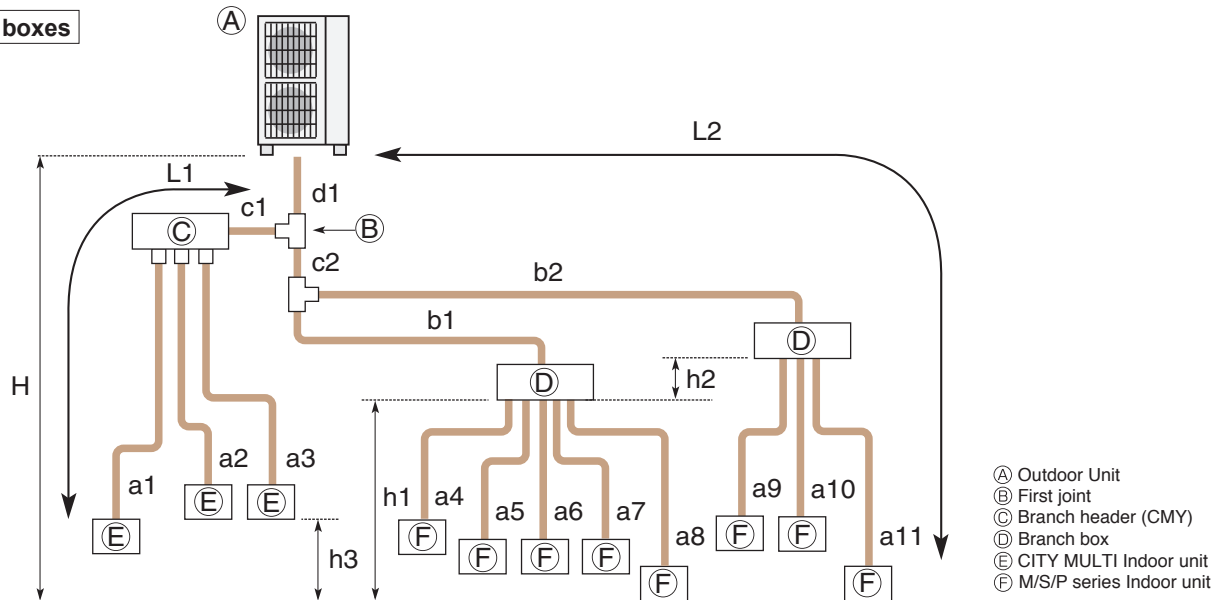

- Ⓐ Outdoor Unit
- Ⓑ First joint
- Ⓒ Branch header (CMY)
- Ⓓ Branch box
- Ⓔ CITY MULTI Indoor unit
- Ⓕ M/S/P series Indoor unit

Permissible length (One-way)	Total piping length	$d1 + c1 + c2 + b1 + b2 + a1 + a2 + a3 + a4 + a5 + a6 + a7 + a8 + a9 + a10 + a11 \leq 150 \text{ m}$
	Farthest piping length (L1)	$d1 + c1 + a1 \leq 80 \text{ m}$
	Farthest piping length. Via Branch box (L2)	$d1 + c2 + b2 + a11 \leq 80 \text{ m}$
	Piping length between outdoor unit and branch boxes	$d1 + c2 + b1 + b2 \leq 55 \text{ m}$
	Farthest piping length from the first joint	$c2 + b2 \text{ or } c1 + a1 \leq 30 \text{ m}$
	Farthest piping length after branch box	$a11 \leq 25 \text{ m}$
	Farthest branch box from outdoor unit	$d1 + c2 + b2 \leq 55 \text{ m}$
	Total piping length between branch boxes and indoor units	$a4 + a5 + a6 + a7 + a8 + a9 + a10 + a11 \leq 95 \text{ m}$
Permissible height difference (One-way)	In indoor/outdoor section (H)*1	$H \leq 50 \text{ m}$ (In case of outdoor unit is set higher than indoor unit) $H \leq 40 \text{ m}$ (In case of outdoor unit is set lower than indoor unit)
	In branch box/indoor unit section (h1)	$h1 + h2 \leq 15 \text{ m}$
	In each branch unit (h2)	$h2 \leq 15 \text{ m}$
	In each indoor unit (h3)	$h3 \leq 12 \text{ m}$
Number of bends		$ld1 + c1 + a1, ld1 + c1 + a2, ld1 + c1 + a3, ld1 + c2 + b1 + a4, ld1 + c2 + b1 + a5, ld1 + c2 + b1 + a6, ld1 + c2 + b1 + a7, ld1 + c2 + b1 + a8, ld1 + c2 + b1 + a9, ld1 + c2 + b2 + a10, ld1 + c2 + b2 + a11 \leq 15$

*1: Branch box should be placed within the level between the outdoor unit and indoor units.

Explanation of Terminology

Maximum piping length:

This is the [maximum allowable length of the refrigerant piping](#). The amount of refrigerant pipe used cannot be longer than the length specified.

Total length:

The maximum allowable combined length of all the refrigerant piping between the outdoor unit and indoor unit(s).

Outdoor Unit - Indoor Unit:

The [maximum allowable length](#) of the refrigerant piping [between the outdoor unit and indoor units installed](#) when multiple units are connected to a single outdoor unit. This distance limitation refers to the maximum length between the outdoor unit and the farthest indoor unit.

Pipe length difference from distribution pipe:

The [maximum allowable difference](#) in refrigerant piping length [from the distribution pipe to the farthest indoor unit and from the distribution pipe to the closest indoor unit](#) when multiple indoor units are connected to a single outdoor unit using a distribution pipe.

Indoor Unit - Distribution Pipe:

The [maximum allowable length](#) of the refrigerant piping [between indoor units and the distribution pipe](#) when multiple indoor units are connected to a single outdoor unit.

Maximum height difference:

This is the [maximum allowable height difference](#). It is necessary to install the air conditioning system so that the height distance is no more than the difference specified. (Specified differences may vary if the outdoor unit is installed higher or lower than the indoor units).

Outdoor unit - Indoor unit:

The [maximum allowable difference](#) in height [between the outdoor unit and indoor units](#) when installed (when multiple indoor units are connected to a single outdoor unit, this distance limitation refers to the maximum height difference between the outdoor unit and an indoor unit).

Indoor unit - Indoor unit:

The [maximum allowable difference](#) [between the heights of indoor units](#) when multiple indoor units are connected to a single outdoor unit.

Maximum number of bends:

This is the [maximum allowable number of bends in the refrigerant piping](#). The total number of bends in the refrigerant piping used cannot exceed the number specified.

Total number:

The maximum allowable number of bends for all refrigerant piping between the outdoor unit and indoor units.

Outdoor unit - Indoor unit:

The [maximum allowable number](#) of bends [between the outdoor unit and each indoor unit](#) when multiple indoor units are connected to a single outdoor unit.

Conditions for specifications

Temperature conditions are based on JIS B8616.

Cooling	Indoor	27°C DB, 19°C WB
	Outdoor	35°C DB, 24°C WB
Heating	Indoor	20°C DB
	Outdoor	7°C DB, 6°C WB

Refrigerant piping length ; 5m

The figures for total input are based on the following voltages.

Series	Indoor unit	Outdoor unit
M Series S Series P Series (except for PEA) MXZ Series POWERFUL HEATING Series	-	VG,VE,VA,VHA,VKA:230V/Single phase/50Hz YA,YHA,YKA:400V/Three phase/50Hz
PEA Series	400V/Three phase/50Hz	400V/Three phase/50Hz

Sound pressure level

- The sound pressure measurement is conducted in an anechoic chamber.
- The actual sound level depends on the distance from the unit and the acoustic environment.

How to read a model name

1) M & S Series

M	M : M Series S : S Series
S	"S"= Wall-mounted , "F"= Compact floor-standing , "E"= Compact ceiling-concealed , "L"= 4- or 1-way cassette , "U"= Outdoor unit
Z	"Z"= Inverter heat pump , "H"= Fixed-speed heat pump , "blank"= Cooling only of Non-inverter , "Y"= Cooling only of inverter
-	
F	Series
H	Generation
25	Rated cooling capacity (kW base)
V	230V / Single phase / 50Hz
E	"A"= R410A with new A control , "B"= R410A with conventional control , "E"= R410A with new A control & ErP correspondance , "G"=R32 with new A control & ErP correspondance , "F"= R32 with new A control
HZ	"HZ"= Hyper Heating model , "H"= Anti-freeze heater equipped model , "S"= Silver indoor unit , "W"= White/Natural White indoor unit , "B"= Black/Onyx Black indoor unit , "V"= Pearl White indoor unit , "R"= Ruby Red indoor unit

2) P Series

P	P Series
U	"K"= Wall-mounted , "S"= Floor-standing , "L"= 4-way cassette , "E"= Ceiling-concealed , "C"= Ceiling-suspended , "U"= Outdoor unit
H	"H"= For heating and cooling
Z	"Z"= Inverter
-	

ZM/M/ZRP/RP/P "ZM"= R32 Eco-conscious Power Inverter , "M"= R32 &R410A

"ZRP"/"RP"= R410A & cleaning-free pipe reuse , "P"=R410A

SHW "SH"= Powerful heating ZUBADAN , "W"= can be used as air to water application

71	Rated cooling capacity (kW base)
V	"V"= 230V / Single phase / 50Hz , "Y"= 400V / Three phase / 50Hz
H	Generation
A	"A"= A control

3) MXZ Series

M	M Series
X	Multi-system outdoor unit (heat pump)
Z	Inverter heat pump
-	
4	Maximum number of connectable indoor units
D/E/F/HJ/DM	Generation / Type
72	Rated cooling capacity (kW base)
V	"V"= 230V / Single phase / 50Hz
A	"A"= R410A with new A control
HZ	"HZ"= Hyper Heating model , "H"= Anti-freeze heater equipped model

Refrigerant Amount

M/S/P/Multi/Zubadan/ATW

	Model Name	Refrigerant	Pre-charged quantity		Max. added quantity		
			GWP	Weight (kg)	CO ₂ equivalent (t)	Weight (kg)	CO ₂ equivalent (t)
M-Series	MUZ-LN25VG	R32	675	1.00	0.68	0.26	0.18
	MUZ-LN35VG	R32	675	1.00	0.68	0.26	0.18
	MUZ-LN50VG	R32	675	1.25	0.85	0.26	0.18
	MUZ-LN60VG	R32	675	1.45	0.98	0.46	0.32
	MUZ-LN25VGHZ	R32	675	1.00	0.68	0.26	0.18
	MUZ-LN35VGHZ	R32	675	1.00	0.68	0.26	0.18
	MUZ-LN50VGHZ	R32	675	1.45	0.98	0.46	0.32
	MUZ-AP25VG	R32	675	0.55	0.37	0.26	0.18
	MUZ-AP35VG	R32	675	0.55	0.37	0.26	0.18
	MUZ-AP42VG	R32	675	0.70	0.47	0.26	0.18
	MUZ-AP50VG	R32	675	1.00	0.68	0.26	0.18
	MUZ-AP25VGH	R32	675	0.55	0.37	0.26	0.18
	MUZ-AP35VGH	R32	675	0.55	0.37	0.26	0.18
	MUZ-AP42VGH	R32	675	0.70	0.47	0.26	0.18
	MUZ-AP50VGH	R32	675	1.00	0.68	0.26	0.18
	MUZ-FH25VE	R410A	2088	1.15	2.41	0.39	0.82
	MUZ-FH35VE	R410A	2088	1.15	2.41	0.39	0.82
	MUZ-FH50VE	R410A	2088	1.55	3.24	0.46	0.97
	MUZ-FH25VEHZ	R410A	2088	1.15	2.41	0.39	0.82
	MUZ-FH35VEHZ	R410A	2088	1.15	2.41	0.39	0.82
	MUZ-FH50VEHZ	R410A	2088	1.55	3.24	0.46	0.97
	MUZ-EF25VG(H)	R32	675	0.62	0.42	0.26	0.18
	MUZ-EF35VG(H)	R32	675	0.74	0.50	0.26	0.18
	MUZ-EF42VG	R32	675	0.74	0.50	0.26	0.18
	MUZ-EF50VG	R32	675	1.05	0.71	0.46	0.32
	MUZ-SF25VE(H)	R410A	2088	0.7	1.47	0.39	0.82
	MUZ-SF35VE(H)	R410A	2088	0.8	1.68	0.39	0.82
	MUZ-SF42VE(H)	R410A	2088	1.15	2.41	0.39	0.82
	MUZ-SF50VE(H)	R410A	2088	1.55	3.24	0.46	0.97
	MUZ-GF60VE	R410A	2088	1.55	3.24	0.4	0.84
	MUZ-GF71VE	R410A	2088	1.9	3.97	1.1	2.30
	MUZ-WN25VA	R410A	2088	0.7	1.47	0.26	0.55
	MUZ-WN35VA	R410A	2088	0.7	1.47	0.26	0.55
	MUY-TP35VF	R32	675	0.85	0.57	0.13	0.09
	MUY-TP50VF	R32	675	0.85	0.57	0.13	0.09
	MUZ-DM25VA	R410A	2088	0.7	1.47	0.26	0.55
	MUZ-DM35VA	R410A	2088	0.72	1.51	0.26	0.55
	MUZ-HJ25VA	R410A	2088	0.7	1.47	0.26	0.55
	MUZ-HJ35VA	R410A	2088	0.72	1.51	0.26	0.55
	MUZ-HJ50VA	R410A	2088	1.15	2.41	0.26	0.55
	MUZ-HJ60VA	R410A	2088	1.8	3.76	0.46	0.97
	MUZ-HJ71VA	R410A	2088	1.8	3.76	0.46	0.97
	MUZ-HR25VF	R32	675	0.40	0.27	0.26	0.18
	MUZ-HR35VF	R32	675	0.45	0.30	0.26	0.18
MUZ-HR42VF	R32	675	0.70	0.47	0.26	0.18	
MUZ-HR50VF	R32	675	0.80	0.54	0.26	0.18	
MUFZ-KJ25VE	R410A	2088	1.1	2.30	0.39	0.82	
MUFZ-KJ35VE	R410A	2088	1.1	2.30	0.39	0.82	
MUFZ-KJ50VE	R410A	2088	1.5	3.14	0.46	0.97	
MUFZ-KJ25VEHZ	R410A	2088	1.1	2.30	0.39	0.82	
MUFZ-KJ35VEHZ	R410A	2088	1.1	2.30	0.39	0.82	
MUFZ-KJ50VEHZ	R410A	2088	1.5	3.14	0.46	0.97	
MXZ-2D33VA	R410A	2088	1.15	2.72	0.0	0.00	
MXZ-2D42VA2	R410A	2088	1.3	2.72	0.2	0.42	
MXZ-2D53VA(H)2	R410A	2088	1.3	2.72	0.2	0.42	
MXZ-3E54VA	R410A	2088	2.7	5.64	0.2	0.42	
MXZ-3E68VA	R410A	2088	2.7	5.64	0.4	0.84	
MXZ-4E72VA	R410A	2088	2.7	5.64	0.4	0.84	
MXZ-4E83VA	R410A	2088	2.99	6.25	0.9	1.88	
MXZ-5E102VA	R410A	2088	2.99	6.25	1.6	3.35	
MXZ-6D122VA	R410A	2088	4.0	8.36	1.0	2.09	
MXZ-2F33VF	R32	675	1.0	0.68	0.00	0.00	
MXZ-2F42VF	R32	675	1.2	0.81	0.00	0.00	
MXZ-2F53VF(H)	R32	675	1.2	0.81	0.00	0.00	
MXZ-3F54VF	R32	675	1.4	0.95	1.0	0.68	
MXZ-3F68VF	R32	675	1.4	0.95	1.0	0.68	
MXZ-4F72VF	R32	675	1.4	0.95	1.0	0.68	
MXZ-2E53VAHZ	R410A	2088	2.0	4.18	0.2	0.42	
MXZ-4E83VAHZ	R410A	2088	3.9	8.15	0.9	1.88	
MXZ-2DM40VA	R410A	2088	0.95	1.99	0.2	0.42	
MXZ-3DM50VA	R410A	2088	2.7	5.64	0.2	0.42	
MXZ-2HA40VF	R32	675	0.9	0.61	0.9	0.61	
MXZ-2HA50VF	R32	675	0.9	0.61	0.9	0.61	
MXZ-3HA50VF	R32	675	1.4	0.95	1.6	1.08	
S-Series	SUZ-M25VA	R32	675	0.65	0.44	0.91	0.61
	SUZ-M35VA	R32	675	0.9	0.61	1.16	0.78
	SUZ-M50VA	R32	675	1.2	0.81	1.66	1.12
	SUZ-M60VA	R32	675	1.25	0.84	1.71	1.15
	SUZ-M71VA	R32	675	1.45	0.98	2.37	1.60
	SUZ-KA25VA6	R410A	2088	0.8	1.68	0.39	0.82
	SUZ-KA35VA6	R410A	2088	1.15	2.41	0.39	0.82
	SUZ-KA50VA6	R410A	2088	1.6	3.35	0.46	0.97
	SUZ-KA60VA6	R410A	2088	1.6	3.35	0.46	0.97
	SUZ-KA71VA6	R410A	2088	1.8	3.76	1.265	2.65

	Model Name	Refrigerant	Pre-charged quantity		Max. added quantity			
			GWP	Weight (kg)	CO ₂ equivalent (t)	Weight (kg)	CO ₂ equivalent (t)	
P-Series	PUZ-ZM35VKA	R32	675	2.0	1.35	0.3	0.20	
	PUZ-ZM50VKA	R32	675	2.0	1.35	0.3	0.20	
	PUZ-ZM60VHA	R32	675	2.8	1.89	0.8	0.54	
	PUZ-ZM71VHA	R32	675	2.8	1.89	0.8	0.54	
	PUZ-ZM100VKA	R32	675	4.0	2.70	2.8	1.89	
	PUZ-ZM100YKA	R32	675	4.0	2.70	2.8	1.89	
	PUZ-ZM125VKA	R32	675	4.0	2.70	2.8	1.89	
	PUZ-ZM125YKA	R32	675	4.0	2.70	2.8	1.89	
	PUZ-ZM140VKA	R32	675	4.0	2.70	2.8	1.89	
	PUZ-ZM140YKA	R32	675	4.0	2.70	2.8	1.89	
	PUHZ-ZRP35VKA2	R410A	2088	2.2	4.60	0.4	0.84	
	PUHZ-ZRP50VKA2	R410A	2088	2.4	5.02	0.4	0.84	
	PUHZ-ZRP60VHA2	R410A	2088	3.5	7.31	1.2	2.51	
	PUHZ-ZRP71VHA2	R410A	2088	3.5	7.31	1.2	2.51	
	PUHZ-ZRP100VKA3	R410A	2088	5.0	10.44	2.4	5.02	
	PUHZ-ZRP100YKA3	R410A	2088	5.0	10.44	2.4	5.02	
	PUHZ-ZRP125VKA3	R410A	2088	5.0	10.44	2.4	5.02	
	PUHZ-ZRP140VKA3	R410A	2088	5.0	10.44	2.4	5.02	
	PUHZ-ZRP140YKA3	R410A	2088	5.0	10.44	2.4	5.02	
	PUHZ-ZRP200YKA3	R410A	2088	7.1	14.83	3.6	7.52	
	PUHZ-ZRP250YKA3	R410A	2088	7.7	16.08	4.8	10.03	
	PUZ-M100VKA	R32	675	3.1	2.09	4.1	2.77	
	PUZ-M100YKA	R32	675	3.1	2.09	4.1	2.77	
	PUZ-M125VKA	R32	675	3.6	2.43	5.0	3.38	
	PUZ-M125YKA	R32	675	3.6	2.43	5.0	3.38	
	PUZ-M140VKA	R32	675	3.6	2.43	5.0	3.38	
	PUZ-M140YKA	R32	675	3.6	2.43	5.0	3.38	
	PUHZ-P100VKA	R410A	2088	3.3	6.89	1.2	2.51	
	PUHZ-P100YKA	R410A	2088	3.3	6.89	1.2	2.51	
	PUHZ-P125VKA	R410A	2088	3.8	7.93	1.2	2.51	
	PUHZ-P125YKA	R410A	2088	3.8	7.93	1.2	2.51	
	PUHZ-P140VKA	R410A	2088	3.8	7.93	1.2	2.51	
	PUHZ-P140YKA	R410A	2088	3.8	7.93	1.2	2.51	
	PUHZ-P200YKA3	R410A	2088	6.5	13.58	3.6	7.52	
	PUHZ-P250YKA3	R410A	2088	7.7	16.08	4.8	10.03	
	PUHZ-SHW112VHA	R410A	2088	5.5	11.49	2.4	5.02	
	PUHZ-SHW112YHA	R410A	2088	5.5	11.49	2.4	5.02	
	PUHZ-SHW140VHA	R410A	2088	5.5	11.49	2.4	5.02	
	PUHZ-SHW140YHA	R410A	2088	5.5	11.49	2.4	5.02	
	PUHZ-FRP71VHA	R410A	2088	3.8	7.94	1.8	3.76	
	PUMY	PUMY-SP112VKM(-BS)	R410A	2088	3.5	7.31	9.0	18.79
		PUMY-SP112YKM(-BS)	R410A	2088	3.5	7.31	9.0	18.79
		PUMY-SP125VKM(-BS)	R410A	2088	3.5	7.31	9.0	18.79
		PUMY-SP125YKM(-BS)	R410A	2088	3.5	7.31	9.0	18.79
PUMY-SP140VKM(-BS)		R410A	2088	3.5	7.31	9.0	18.79	
PUMY-SP140YKM(-BS)		R410A	2088	3.5	7.31	9.0	18.79	
PUMY-SP112VKM4(-BS)		R410A	2088	4.8	10.02	13.8	28.81	
PUMY-SP125VKM4(-BS)		R410A	2088	4.8	10.02	13.8	28.81	
PUMY-SP140VKM4(-BS)		R410A	2088	4.8	10.02	13.8	28.81	
PUMY-P112YKM(E4(-BS)		R410A	2088	4.8	10.02	13.8	28.81	
PUMY-P125YKM(E4(-BS)		R410A	2088	4.8	10.02	13.8	28.81	
PUMY-P140YKM(E4(-BS)		R410A	2088	4.8	10.02	13.8	28.81	
PUMY-P200YKM2(-BS)		R410A	2088	7.3	15.24	13.1	27.35	
ATW Packaged		PUHZ-W50VHA2(-BS)	R410A	2088	1.7	3.55	-	-
		PUHZ-W85VHA2(-BS)	R410A	2088	2.4	5.02	-	-
	PUHZ-W112VHA(-BS)	R410A	2088	4.0	8.36	-	-	
	PUHZ-W60VAA(-BS)	R410A	2088	2.4	5.01	-	-	
	PUHZ-W85VAA(-BS)	R410A	2088	2.4	5.01	-	-	
	PUHZ-W85YAA(-BS)	R410A	2088	2.4	5.01	-	-	
	PUHZ-W112VAA(-BS)	R410A	2088	3.3	6.89	-	-	
	PUHZ-W112YAA(-BS)	R410A	2088	3.3	6.89	-	-	
	PUHZ-HW112YHA2(-BS)	R410A	2088	4.0	8.36	-	-	
	PUHZ-HW1140VHA2(-BS)	R410A	2088	4.3	8.98	-	-	
	PUHZ-HW1140YHA2(-BS)	R410A	2088	4.3	8.98	-	-	
	SUHZ-SW45VA(H)	R410A	2088	1.3	2.72	0.35	0.72	
	PUHZ-SW50VKA(-BS)	R410A	2088	1.4	2.93	0.6	1.26	
	PUHZ-SW75VAA(-BS)	R410A	2088	3.0	6.27	1.8	3.76	
	PUHZ-SW75YAA(-BS)	R410A	2088	3.0	6.27	1.8	3.76	
PUHZ-SW100VAA(-BS)	R410A	2088	4.2	8.77	1.8	3.76		
PUHZ-SW100YAA(-BS)	R410A	2088	4.2	8.77	1.8	3.76		
PUHZ-SW75VHA(-BS)	R410A	2088	3.2	6.69	1.4	2.93		
PUHZ-SW100VHA(-BS)	R410A	2088	4.6	9.61	2.9	6.06		
PUHZ-SW100YHA(-BS)	R410A	2088	4.6	9.61	2.9	6.06		
PUHZ-SW120VHA(-BS)	R410A	2088	4.6	9.61	2.9	6.06		
PUHZ-SW160YKA(-BS)	R410A	2088	7.1	14.83	4.0	8.36		
PUHZ-SW200YKA(-BS)	R410A	2088	7.7	16.08	5.2	10.86		
PUHZ-SHW80VAA	R410A	2088	4.6	9.61	1.4	2.93		
PUHZ-SHW80YAA	R410A	2088	4.6	9.61	1.4	2.93		
PUHZ-SHW112VAA	R410A	2088	4.6	9.61	1.4	2.93		
PUHZ-SHW112YAA	R410A	2088	4.6	9.61	1.4	2.93		
PUHZ-SHW80VHA	R410A	2088	5.5	11.49	2.4	5.02		
PUHZ-SHW112VHA	R410A	2088	5.5	11.49	2.4	5.02		
PUHZ-SHW112YHA	R410A	2088	5.5	11.49	2.4	5.02		
PUHZ-SHW140YHA	R410A	2088	5.5	11.49	2.4	5.02		
PUHZ-SHW230YKA2	R410A	2088	7.1	14.83	8.4	17.54		
Mr. Slim+	PUHZ-FRP71VHA2	R410A	2088	3.8	7.94	1.8	3.76	

R32 REFRIGERANT

R32 REFRIGERANT PROPERTIES

Under the conditions shown below, there is a possibility that R32 could ignite.

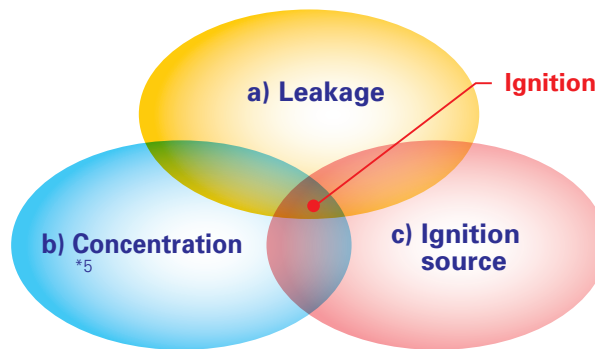

	R32	R410A	R22
Chemical formula	CH ₂ F ₂	CH ₂ F ₂ /CHF ₂ CF ₃	CHClF ₂
Composition (blend ratio wt. %)	Single composition	R32/R125 (50/50 wt %)	Single composition
Ozone depletion potential (ODP)	0	0	0.055
Global warming potential (GWP) *1	675	2088	1810
LFL(vol.%) *2	13.3	-	-
UFL(vol.%) *3	29.3	-	-
Flammability *4	Lower flammability (2L)	No flame propagation (1)	No flame propagation (1)

*1 IPCC 4th assessment report.

*2 LFL : Lower flammable limit

*3 UFL : Upper flammable limit

*4 ISO 817:2014

*5 R32 consistency is higher than LFL*¹ and lower than UFL*².

Although R32 is classified as low flammability, the possibility of igniting can be eliminated by ensuring the following three points.

a) Do not leak refrigerant.

- <Installation> ·Vacuum drying should be done. Air purging is prohibited.
- Follow "4. Installation Points of Refrigerant Piping Work".
- <Repair/Relocation/Removal> ·Pump down or recovering refrigerant should be done.

b) Prevent concentration.

- Ventilate during installation and servicing, such as open the door or window and use a fan.
- Follow "2. Installation Restrictions".

c) Keep ignition source away from the unit.

- Do not braze pipe and unit which contain refrigerant. Before brazing, refrigerant should be recovered.
- Do not install unit while the electricity is turned on. Turn off electricity at the fuse box and check the wiring using a tester.
- Do not smoke when working or during transportation of the product.

Note Both R32 / R410A emit a toxic gas when coming into contact with an open flame.

INSTALLATION RESTRICTIONS

In order to prevent the refrigerant from igniting, use the following instructions during installation.

1) Indoor Units

Install in a room with a floor area of A_{min}^* or more, corresponding to refrigerant quantity M.

(M = factory-charged refrigerant + locally added refrigerant)

Install the indoor unit so that the height from the floor to the bottom of the indoor unit is h_0^* .

* Refer to table and drawings below.

<M & P Series>

M[kg]	$A_{min}[m^2]$
1.0	4
1.5	6
2.0	8
2.5	10
3.0	12
3.5	14
4.0	16
4.5	20
5.0	24
5.5	29
6.0	35
6.5	41
7.0	47
7.5	54

<MXZ Series>

M[kg]	$A_{min}[m^2]$
1.0	3
1.5	4.5
2.0	6
2.5	7.5
3.0	9
3.5	12
4.0	15.5
4.5	20
5.0	24
5.5	29
6.0	35
6.5	41
7.0	47
7.5	54

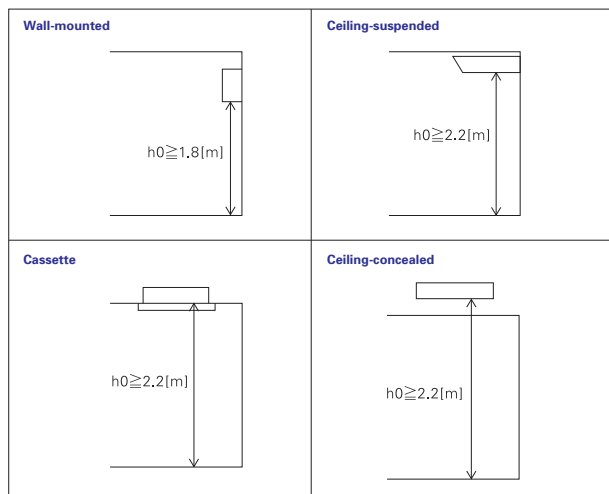

2) Outdoor Units

Install outdoor units in a place where at least one of the four sides is open or in a sufficiently large space without depressions.

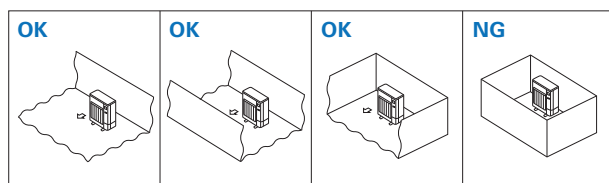

If you unavoidably install a unit in a space where all four sides are blocked or there are depressions, confirm that one of these situations (A, B or C) is satisfied.

A Secure sufficient installation space (minimum installation area A_{min}).

Install in a space with an installation area of A_{min}^* or more, corresponding to refrigerant quantity M. (M = factory-charged refrigerant + locally added refrigerant)

* Refer to table and drawings below.

M[kg]	$A_{min}[m^2]$
1.0	12
1.5	17
2.0	23
2.5	28
3.0	34
3.5	39
4.0	45
4.5	50
5.0	56
5.5	62
6.0	67
6.5	73
7.0	78
7.5	84

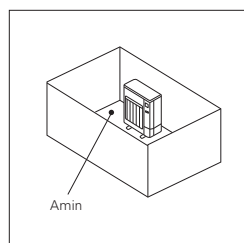

B Install in a space with a depression height of $\leq 0.125[m]$.

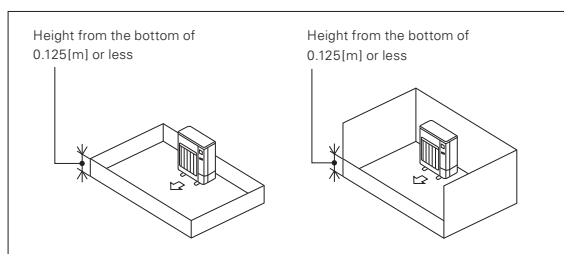

C Create an appropriate open ventilation area.

Make sure that the width of the open area is 0.9[m] or more and the height of the open area is 0.15[m] or more. However, the height from the bottom of the installation space to the bottom edge of the open area should be 0.125[m] or less. More than 75% of the ventilation area should be open to allow air circulation.

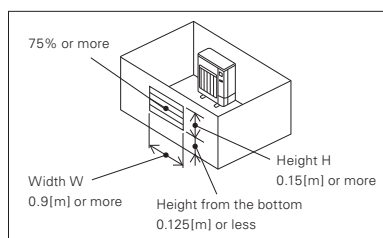





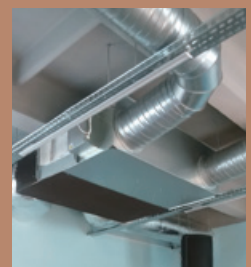

Note These countermeasures (A, B or C) are for keeping safety not for specification guarantee.

● Models with R32 Refrigerant: MSZ-L Series (single connection)

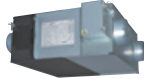
L OSSNAY SYSTEM

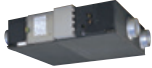

LOSSNAY LINE-UP

Application	Air volume		50	100	150	250	350	500	650	800	1000	1500	2000	2500
	Model		CMH	CMH	CMH	CMH	CMH	CMH	CMH	CMH	CMH	CMH	CMH	CMH
Commerical Use	LGH-RVX Series				●	●	●	●	●	●	●	●	●	
	LGH-RVXT Series											●	●	●
	GUF Series							●			●			
Optional Unit	Dx-Coil unit for Lossnay LGH-RVX/RVXT Series GUG Series							●	●	●	●	●	●	●
Residential Use	VL-220CZGV-E					●								
	VL-100(E)U5-E			●										
	VL-50(E)S2-E VL-50SR2-E		●											

LGH-RVX Series

This commercially oriented system can be utilized virtually anywhere with high performance and functions.

LGH-RVXT Series

Thin large air volume models in LGH series with high performance and functions.

Dx-Coil Unit (GUG Series)

Temperature control equipment working with Lossnay unit and Mr. Slim outdoor unit.

GUF Series

Heat recovery with heating and cooling system using the heat resource of City Multi outdoor unit.

VL-220CZGV-E

Centralized ventilation for residential use with sensible heat exchange.

VL-100(E)U5-E, VL-50(E)S2-E

Wall mount models. Particularly suitable for houses and small offices.

REMOTE CONTROLLER

PZ-61DR-E

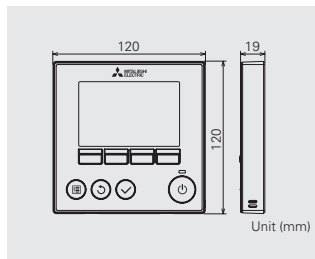

PZ-43SMF-E

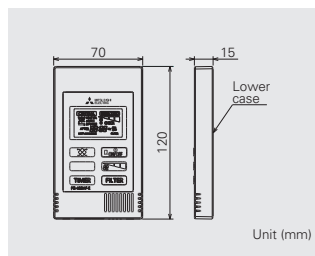

Function (Communicating Mode)	PZ-61DR-E		PZ-43SMF-E	
	LGH-RVX/RVXT	VL-220CZGV-E	LGH-RVX/RVXT	VL-220CZGV-E
Fan speed selection	4 fan speeds	4 fan speeds	2 of 4 fan speeds	2 of 4 fan speeds
Ventilation mode selection	Energy recovery / Bypass / Auto	Heat recovery / Bypass / Auto (available with optional parts P-133DUE-E)	Energy recovery / Bypass / Auto	Heat recovery / Bypass / Auto (available with optional parts P-133DUE-E)
Night-purge (time)	Anytime schedule	No	No	No
Night-purge (fan speed)	Selectable from 4 fan speeds	No	No	No
Function setting from RC	Yes	Yes	No	No
Bypass temp. free setting	Yes	Yes (available with optional parts P-133DUE-E)	No	No
Heater-On temp. free setting	Yes	No	No	No
Fan power change after installation	Yes	Yes	No	No
On/Off timer	Yes	Yes	Yes	Yes
Auto-Off timer	Yes	Yes	No	No
Weekly timer	Yes	Yes	No	No
Operation restrictions (On/Off, ventilation mode, fan speed)	Yes	Yes (ventilation mode is available with optional parts P-133DUE-E)	No	No
Operation restrictions (fan speed skip setting)	Yes	Yes	No	No
Screen contrast adjustment	Yes	Yes	No	No
Language selection	Yes (8 languages)	Yes (8 languages)	No (English Only)	No (English Only)
Initializing remote controller	Yes	Yes	No	No
Filter cleaning sign	Yes	Yes	Yes	Yes
Lossnay core cleaning sign	Yes	No	No	No
Error indication	Yes	Yes	Yes	Yes
Error history	Yes	Yes	No	No

LOSSNAY SYSTEM



Lossnay ventilation systems are renowned industry-wide for their efficiency. They offer environment-friendly energy recovery and humidity control, and enable air conditioning systems to simultaneously provide optimum room comfort and energy savings.

Indoor Air Quality Inside a Building is Optimised Through Temperature and Humidity Exchange by Lossnay

Lossnay is a total heat exchange ventilation system that uses paper characteristics to perform temperature (sensible heat) and humidity (latent heat) exchange.

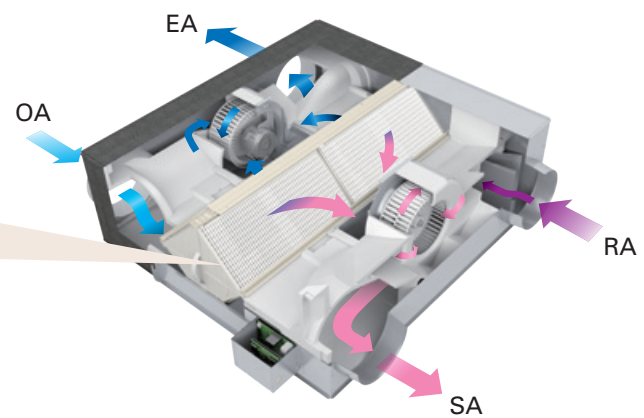
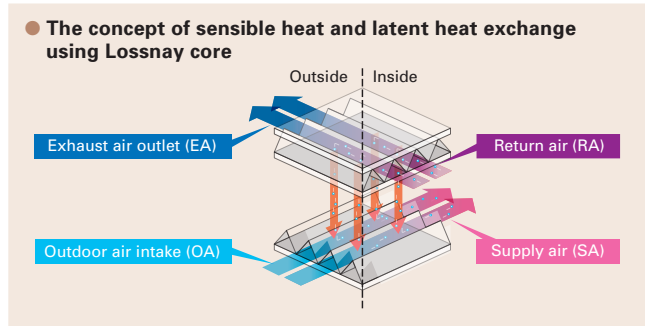

What can be Improved by Introducing Lossnay?

● Ventilation with maximised comfort

In summer

Air similar to the conditions of the cooled (dehumidified) indoor air is supplied.

	LOSSNAY	Conventional ventilator
Dry bulb temperature (°C)	28	33
Absolute humidity (g/kg(DA))	13.3	20.1
Relative humidity (%)	56	63
Enthalpy (kJ/kg(DA))	62.1	84.6
Total energy recovery (kW)	7.5	0
Outdoor air load (kW)	3.1	10.6
Outdoor air load ratio (%)	29	100

Return air	
Dry bulb temperature	26°C
Absolute humidity	10.5g/kg(DA)
Relative humidity	50%
Enthalpy	52.9kJ/kg(DA)

Outdoor air	
Dry bulb temperature	33°C
Absolute humidity	20.1g/kg(DA)
Relative humidity	63%
Enthalpy	84.6kJ/kg(DA)

Heat recovery calculation
 Indoor supply-air temperature (°C) = Outdoor temperature (°C) - { Outdoor temperature (°C) - Indoor temperature (°C) } × Temp recovery efficiency (%)
 Calculation example: 28°C = 33°C - (33°C - 26°C) × 72%

*The above applies to the case of LGH-100RVX (fan speed 4).

In winter

Air similar to the conditions of the heated (humidified) indoor air is supplied.

	LOSSNAY	Conventional ventilator
Dry bulb temperature (°C)	16	0
Absolute humidity (g/kg(DA))	5.2	1.9
Relative humidity (%)	46	50
Enthalpy (kJ/kg(DA))	29.2	4.7
Total energy recovery (kW)	8.2	0
Outdoor air load (kW)	3.1	11.3
Outdoor air load ratio (%)	28	100

Return air	
Dry bulb temperature	20°C
Absolute humidity	7.3g/kg(DA)
Relative humidity	50%
Enthalpy	38.5kJ/kg(DA)

Outdoor air	
Dry bulb temperature	0°C
Absolute humidity	1.9g/kg(DA)
Relative humidity	50%
Enthalpy	4.7kJ/kg(DA)

Heat recovery calculation
 Indoor supply-air temperature (°C) = { Indoor temperature (°C) - Outdoor temperature (°C) } × Temp recovery efficiency (%) + Outdoor temperature (°C)
 Calculation example: 16°C = (20°C - 0°C) × 80% + 0°C

*The above applies to the case of LGH-100RVX (fan speed 4).

Commercial Use Lossnay

LGH-RVX (Standard model)

Power consumption reduced further with introduction of a DC motor

Realized low power consumption with introduction of a high efficiency brushless DC motor. Compared to models with an AC motor, power consumption is reduced.

Comparison between new and previous power consumption
(New model: Fan speed 4 at 230V 50Hz, Previous model: Extra-High at 220V 50Hz)

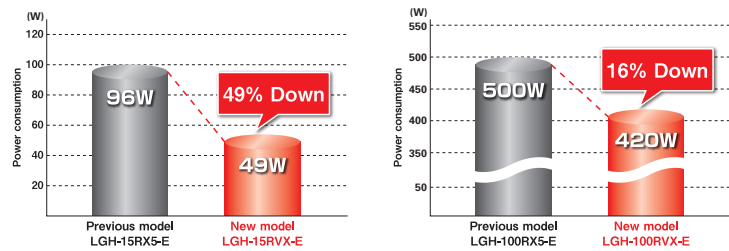

Improved Air Volume Range

Wide range air volume

Each fan speed has a range setting of 25, 50, 75 and 100%, allowing much finer air volume control. When used in combination with the CO₂ sensor or timer function, the air volume can be controlled according to conditions that realize better performance and reduce power consumption.

Fan speed adjustment function

The default fan speed value can be adjusted slightly. Use the PZ-61DR-E remote controller to reset the speed.

- 1) Considering the total hours of Lossnay operation (filter clogging), the fan power can be adjusted automatically after a given period of time.
- 2) After the unit is installed, when if the air volume is slightly lower than the desired airflow, it is possible to make fine adjustments.

■ LGH-RVX/RVXT series model characteristic curves

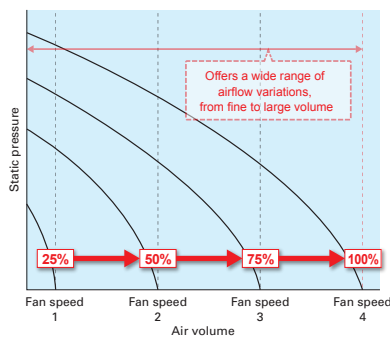

■ P-Q curve image

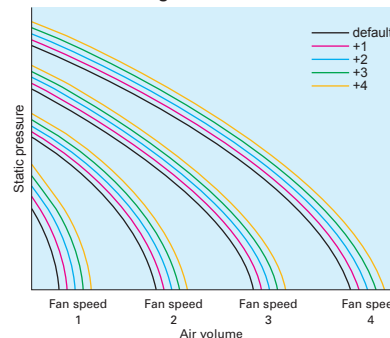

LGH-RVXT (Thinner body type)

The LGH-RVXT series have a large air volume of 1500 - 2500 CMH, but has a thin body @500mm. Installing the unit behind the ceiling is easy.

■ LGH-150/200RVX-E



Height: 808mm

■ LGH-150/200/250RVXT-E



Height: 500mm

38% Thinner body

■ LGH-RVXT Installation image

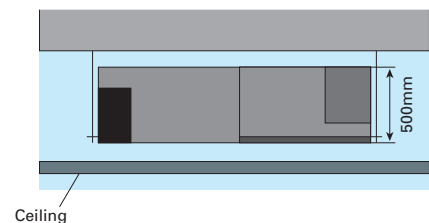

GUF Series (Lossnay with Dx-coil unit)

Along with Lossnay ventilation, the OA Processing Unit is really two units in one, functioning as the main air conditioner when the load is light and adding supplemental air conditioning when the load is heavy.

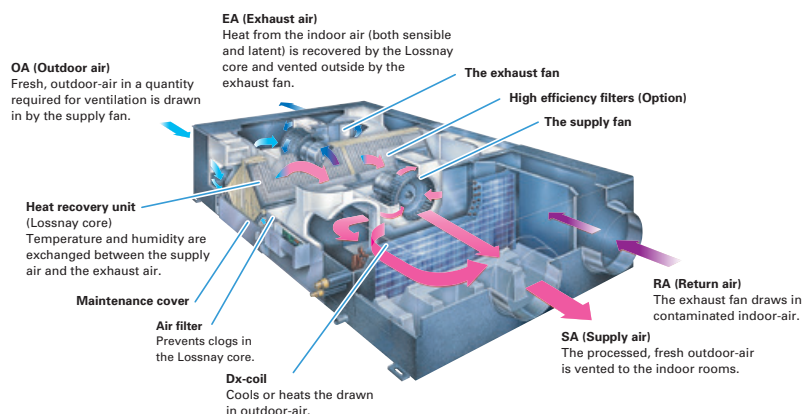

Commercial Use Lossnay Specifications

LGH-RVX Series

Model		LGH-15RVX-E								LGH-25RVX-E								LGH-35RVX-E							
Electrical power supply		220-240V/50Hz, 220V/60Hz								220-240V/50Hz, 220V/60Hz								220-240V/50Hz, 220V/60Hz							
Ventilation mode		Heat recovery mode				Bypass mode				Heat recovery mode				Bypass mode				Heat recovery mode				Bypass mode			
Fan speed		SP4	SP3	SP2	SP1	SP4	SP3	SP2	SP1	SP4	SP3	SP2	SP1	SP4	SP3	SP2	SP1	SP4	SP3	SP2	SP1	SP4	SP3	SP2	SP1
Running current (A)		0.40	0.24	0.15	0.10	0.41	0.25	0.15	0.10	0.48	0.28	0.16	0.10	0.48	0.29	0.16	0.11	0.98	0.54	0.26	0.12	0.98	0.56	0.28	0.13
Input power (W)		49	28	14	7	52	28	14	8	62	33	16	7.5	63	35	17	9	140	70	31	11	145	72	35	13
Air volume	(m ³ /h)	150	113	75	38	150	113	75	38	250	188	125	63	250	188	125	63	350	263	175	88	350	263	175	88
	(L/s)	42	31	21	10	42	31	21	10	69	52	35	17	69	52	35	17	97	73	49	24	97	73	49	24
External static pressure (Pa)		95	54	24	6	95	54	24	6	85	48	21	5	85	48	21	5	160	90	40	10	160	90	40	10
Temperature exchange efficiency (%)		80	81	83	84	-	-	-	-	79	80	82	86	-	-	-	-	80	82.5	86	88.5	-	-	-	-
Enthalpy exchange efficiency (%)	Heating	73	75.5	78	79	-	-	-	-	69.5	72	76	83	-	-	-	-	71.5	74	78.5	83.5	-	-	-	-
	Cooling	71	74.5	78	79	-	-	-	-	68	70	74.5	83	-	-	-	-	71	73	78	82	-	-	-	-
Noise (dB) <small>(Measured at 1.5m under the center of unit in an anechoic chamber)</small>		28	24	19	17	29	24	19	18	27	22	20	17	27.5	23	20	17	32	28	20	17	32.5	28	20	18
Weight (kg)		20								23								30							
Specific energy consumption class		A								A								-							

Model		LGH-50RVX-E								LGH-65RVX-E								LGH-80RVX-E							
Electrical power supply		220-240V/50Hz, 220V/60Hz								220-240V/50Hz, 220V/60Hz								220-240V/50Hz, 220V/60Hz							
Ventilation mode		Heat recovery mode				Bypass mode				Heat recovery mode				Bypass mode				Heat recovery mode				Bypass mode			
Fan speed		SP4	SP3	SP2	SP1	SP4	SP3	SP2	SP1	SP4	SP3	SP2	SP1	SP4	SP3	SP2	SP1	SP4	SP3	SP2	SP1	SP4	SP3	SP2	SP1
Running current (A)		1.15	0.59	0.26	0.13	1.15	0.59	0.27	0.13	1.65	0.90	0.39	0.15	1.72	0.86	0.38	0.16	1.82	0.83	0.36	0.15	1.97	0.86	0.40	0.15
Input power (W)		165	78	32	12	173	81	35	14	252	131	49	15	262	131	47	17	335	151	60	18	340	151	64	20
Air volume	(m ³ /h)	500	375	250	125	500	375	250	125	650	488	325	163	650	488	325	163	800	600	400	200	800	600	400	200
	(L/s)	139	104	69	35	139	104	69	35	181	135	90	45	181	135	90	45	222	167	111	56	222	167	111	56
External static pressure (Pa)		120	68	30	8	120	68	30	8	120	68	30	8	120	68	30	8	150	85	38	10	150	85	38	10
Temperature exchange efficiency (%)		78	81	83.5	87	-	-	-	-	77	81	84	86	-	-	-	-	79	82.5	84	85	-	-	-	-
Enthalpy exchange efficiency (%)	Heating	69	71	75	82.5	-	-	-	-	68.5	71	76	82	-	-	-	-	71	73.5	78	81	-	-	-	-
	Cooling	66.5	68	72.5	82	-	-	-	-	66	69.5	74	81	-	-	-	-	70	72.5	78	81	-	-	-	-
Noise (dB) <small>(Measured at 1.5m under the center of unit in an anechoic chamber)</small>		34	28	19	18	35	29	20	18	34.5	29	22	18	35.5	29	22	18	34.5	30	23	18	36	30	23	18
Weight (kg)		33								38								48							

Model		LGH-100RVX-E								LGH-150RVX-E								LGH-200RVX-E							
Electrical power supply		220-240V/50Hz, 220V/60Hz								220-240V/50Hz, 220V/60Hz								220-240V/50Hz, 220V/60Hz							
Ventilation mode		Heat recovery mode				Bypass mode				Heat recovery mode				Bypass mode				Heat recovery mode				Bypass mode			
Fan speed		SP4	SP3	SP2	SP1	SP4	SP3	SP2	SP1	SP4	SP3	SP2	SP1	SP4	SP3	SP2	SP1	SP4	SP3	SP2	SP1	SP4	SP3	SP2	SP1
Running current (A)		2.50	1.20	0.50	0.17	2.50	1.20	0.51	0.19	3.71	1.75	0.70	0.29	3.85	1.78	0.78	0.30	4.88	2.20	0.88	0.33	4.54	2.06	0.87	0.35
Input power (W)		420	200	75	21	420	200	75	23	670	311	123	38	698	311	124	44	850	400	153	42	853	372	150	49
Air volume	(m ³ /h)	1000	750	500	250	1000	750	500	250	1500	1125	750	375	1500	1125	750	375	2000	1500	1000	500	2000	1500	1000	500
	(L/s)	278	208	139	69	278	208	139	69	417	313	208	104	417	313	208	104	556	417	278	139	556	417	278	139
External static pressure (Pa)		170	96	43	11	170	96	43	11	175	98	44	11	175	98	44	11	150	84	38	10	150	84	38	10
Temperature exchange efficiency (%)		80	83	86.5	89.5	-	-	-	-	80	82.5	84	85	-	-	-	-	80	83	86.5	89.5	-	-	-	-
Enthalpy exchange efficiency (%)	Heating	72.5	74	78	87	-	-	-	-	72	73.5	78	81	-	-	-	-	72.5	74	78	87	-	-	-	-
	Cooling	71	73	77	85.5	-	-	-	-	70.5	72.5	78	81	-	-	-	-	71	73	77	85.5	-	-	-	-
Noise (dB) <small>(Measured at 1.5m under the center of unit in an anechoic chamber)</small>		37	31	23	18	38	32	24	18	39	32	24	18	40.5	33	26	18	40	36	28	18	41	36	27	19
Weight (kg)		54								98								110							

LGH-RVXT Series

Model		LGH-150RVXT-E								LGH-200RVXT-E								LGH-250RVXT-E							
Electrical power supply		220-240V/50Hz, 220V/60Hz								220-240V/50Hz, 220V/60Hz								220-240V/50Hz, 220V/60Hz							
Ventilation mode		Heat recovery mode				Bypass mode				Heat recovery mode				Bypass mode				Heat recovery mode				Bypass mode			
Fan speed		SP4	SP3	SP2	SP1	SP4	SP3	SP2	SP1	SP4	SP3	SP2	SP1	SP4	SP3	SP2	SP1	SP4	SP3	SP2	SP1	SP4	SP3	SP2	SP1
Running current (A)		4.30	2.40	1.10	0.36	3.40	1.80	0.77	0.31	5.40	2.70	1.10	0.39	5.00	2.20	0.85	0.34	7.60	3.60	1.40	0.57	6.90	3.10	1.30	0.49
Input power (W)		792	421	176	48	625	334	134	37	1000	494	197	56	916	407	150	45	1446	687	244	82	1298	587	212	69
Air volume	(m ³ /h)	1500	1125	750	375	1500	1125	750	375	2000	1500	1000	500	2000	1500	1000	500	2500	1875	1250	625	2500	1875	1250	625
	(L/s)	417	313	208	104	417	313	208	104	556	417	278	139	556	417	278	139	694	521	347	174	694	521	347	174
External static pressure (Pa)		175	98	44	11	175	98	44	11	175	98	44	11	175	98	44	11	175	98	44	11	175	98	44	11
Temperature exchange efficiency (%)		80	80.5	81	81.5	-	-	-	-	80	81	82.5	84	-	-	-	-	77	79	80.5	82.5	-	-	-	-
Enthalpy exchange efficiency (%)	Heating	70	71	73	75	-	-	-	-	72.5	73.5	77	83	-	-	-	-	68	71.5	74	79	-	-	-	-
	Cooling	69	70	72	74	-	-	-	-	70	71	74.5	80.5	-	-	-	-	65.5	69	71.5	76.5	-	-	-	-
Noise (dB) <small>(Measured at 1.5m under the center of unit in an anechoic chamber)</small>		39.5	35.5	29.5	22	39	33	26.5	20.5	39.5	35.5	28	22	40.5	34.5	27	20.5	43	39	32	24	44	38.5	31	22.5
Weight (kg)		156								159								198							

GUF Series

Model		GUF-50RD4				GUF-100RD4				GUF-50RDH4				GUF-100RDH4			
Electrical power supply		220-240V/50Hz				220-240V/50Hz				220-240V/50Hz				220-240V/50Hz			
Ventilation mode		Heat recovery mode		Bypass mode		Heat recovery mode		Bypass mode		Heat recovery mode		Bypass mode		Heat recovery mode		Bypass mode	
Fan speed		High	Low	High	Low	High	Low	High	Low	High	Low	High	Low	High	Low	High	Low
Running current (A)		1.15	0.70	1.15	0.70	2.20	1.73	2.25	1.77	1.15	0.70	1.15	0.70	2.20	1.76	2.25	1.77
Input power (W)		235-265	150-165	235-265	150-165	480-505	370-395	490-515	385-410	235-265	150-165	235-265	150-165	480-505	385-400	490-515	385-410
Air volume	(m ³ /h)	500	400	500	400	1000	800	1000	800	500	400	500	400	1000	800	1000	800
	(L/s)	139	111	139	111	278	222	278	222	139	111	139	111	278	222	278	222
External static pressure (Pa)		140	90	140	90	140	90	140	90	125	80	125	80	135	86	135	86
Temperature exchange efficiency (%)		77.5	80	-	-	79.5	81.5	-	-	77.5	80	-	-	79.5	81.5	-	-
Enthalpy exchange efficiency (%)	Heating	68	71	-	-	71	74	-	-	68	71	-	-	71	74	-	-
	Cooling	65	67	-	-	69	71	-	-	65	67	-	-	69	71	-	-
Cooling capacity (kW)		5.57 (1.94)				11.44 (4.12)				5.57 (1.94)				11.44 (4.12)			
Heating capacity (kW)		6.21 (2.04)				12.56 (4.26)				6.21 (2.04)				12.56 (4.26)			
Capacity equivalent to the indoor unit		P32				P63				P32				P63			
Humidifier	Humidifying	-				-				2.7 (heating)				5.4 (heating)			
	Humidifying capacity(kg/h)	-				-				-				-			
	Water supply pressure	-				-				Minimum pressure : 2.0 × 10 ⁴ Pa				Maximum pressure : 49.0 × 10 ⁴ Pa			
Noise (dB) <small>(Measured at 1.5m under the center of the unit)</small>		33.5-34.5	29.5-30.5	35-36	29.5-30.5	38-39	34-35	38-39	35-36	33.5-34.5	29.5-30.5	35-36	29.5-30.5	38-39	34-35	38-39	35-36
Weight (kg)		48				82				51 (filled with water 55)				88 (filled with water 96)			

Characteristic Curves

LGH-15RVX-E

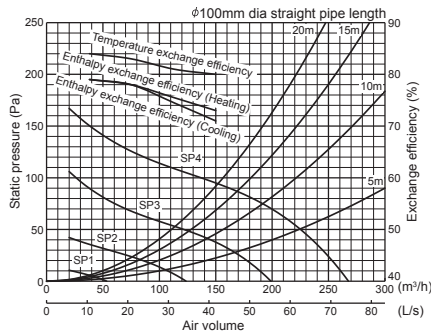

LGH-25RVX-E

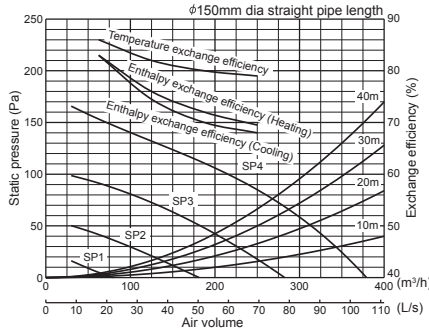

LGH-35RVX-E

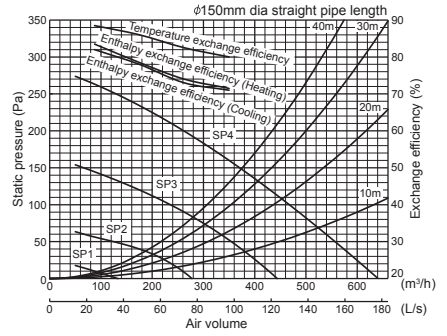

LGH-50RVX-E

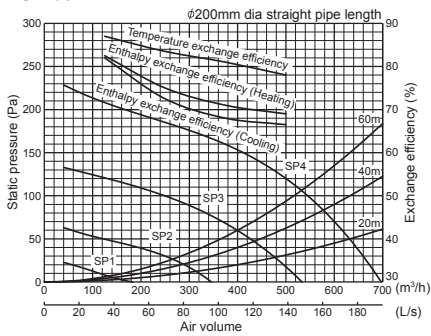

LGH-65RVX-E

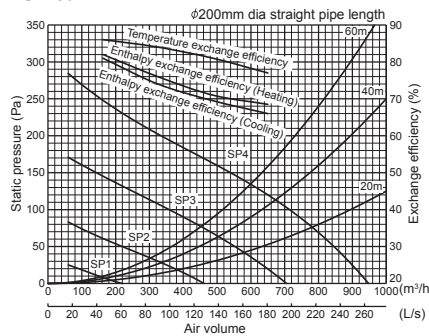

LGH-80RVX-E

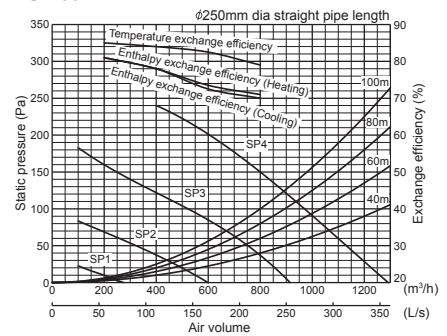

LGH-100RVX-E

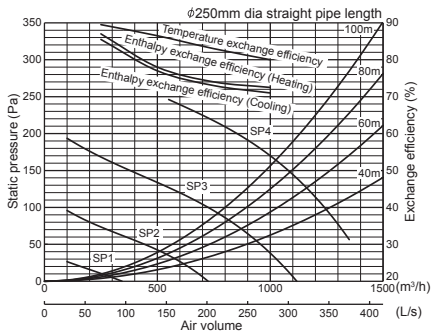

LGH-150RVX-E

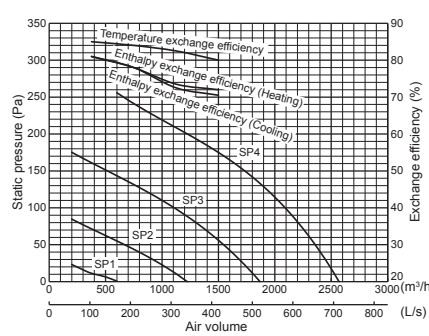

LGH-200RVX-E

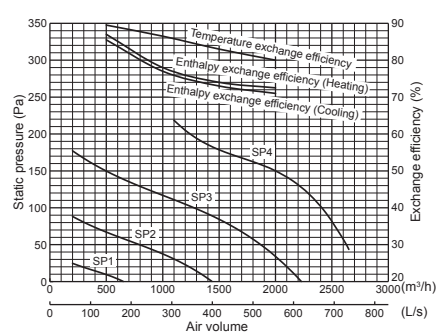

LGH-150RVXT-E

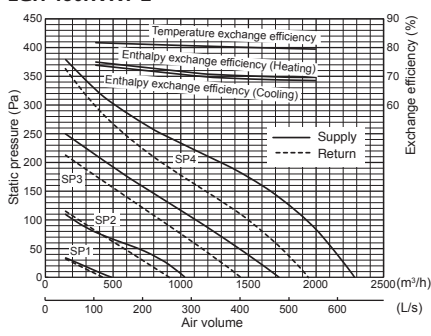

LGH-200RVXT-E

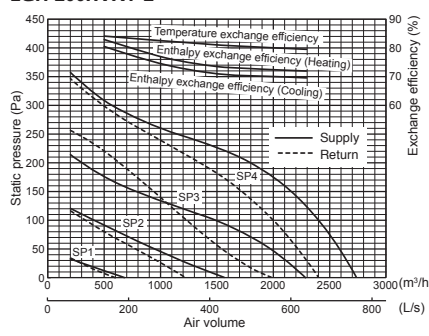

LGH-250RVXT-E

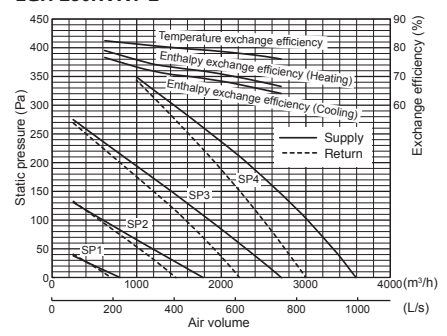

GUF-50RD4

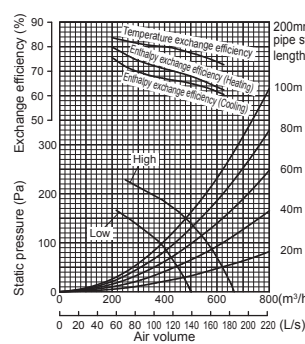

GUF-100RD4

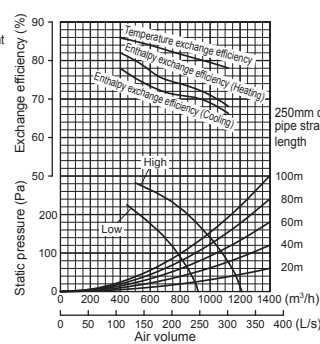

GUF-50RDH4

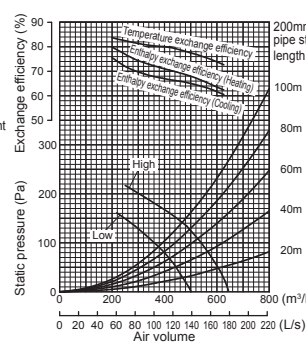

GUF-100RDH4

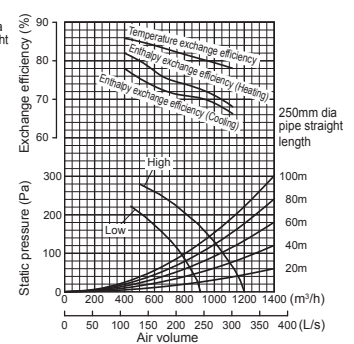

Optional Dx-coil Unit for Lossnay

Supply Comfortable Control

Product Features

- Lossnay return air and supply air temperature control are possible with Dx-coil unit which is connectable with Mr. Slim (Power inverter series)
- Expand the product line-up of Lossnay with temperature control (500-2,500CMH) by the connection of Dx-coil unit. Suitable for various applications such as offices, shops and schools etc.

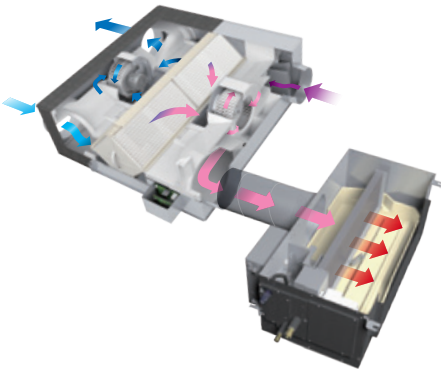

Target Application

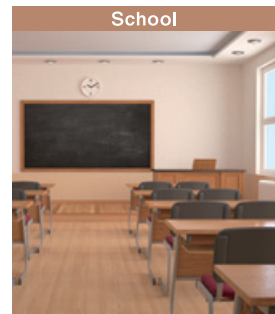
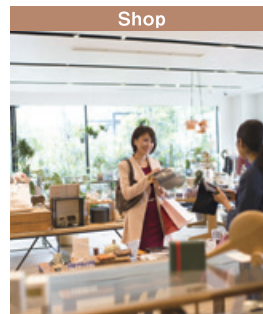
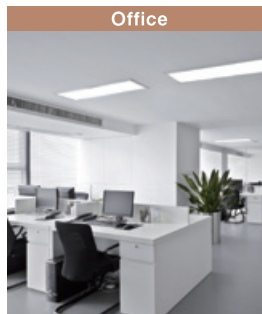

Application Examples

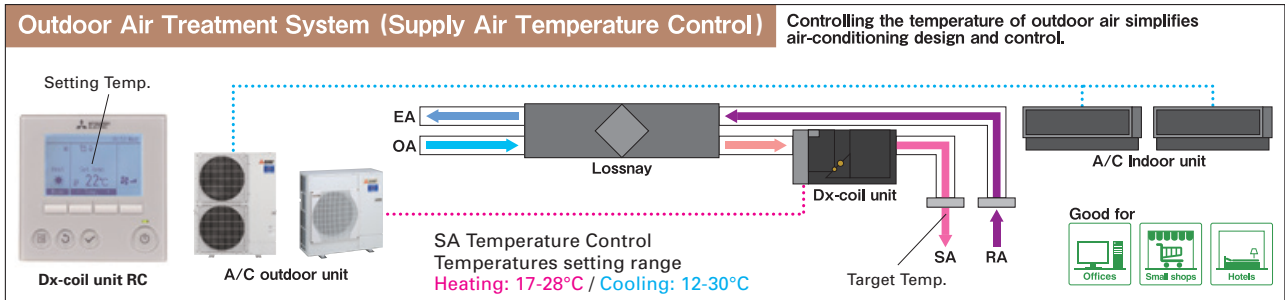
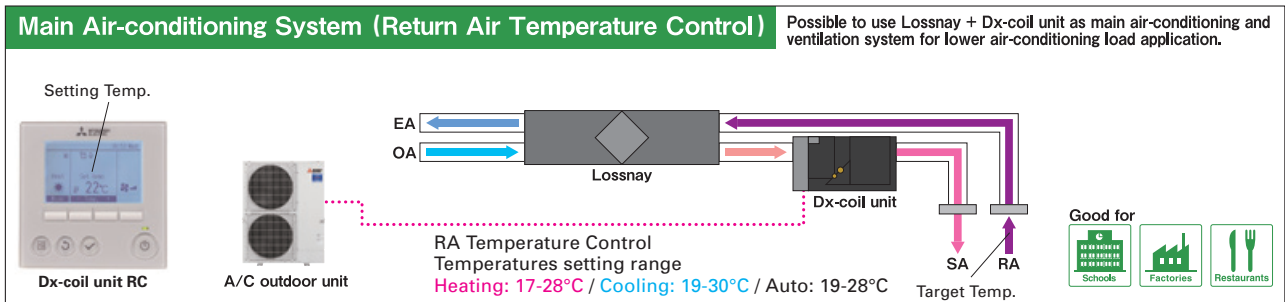
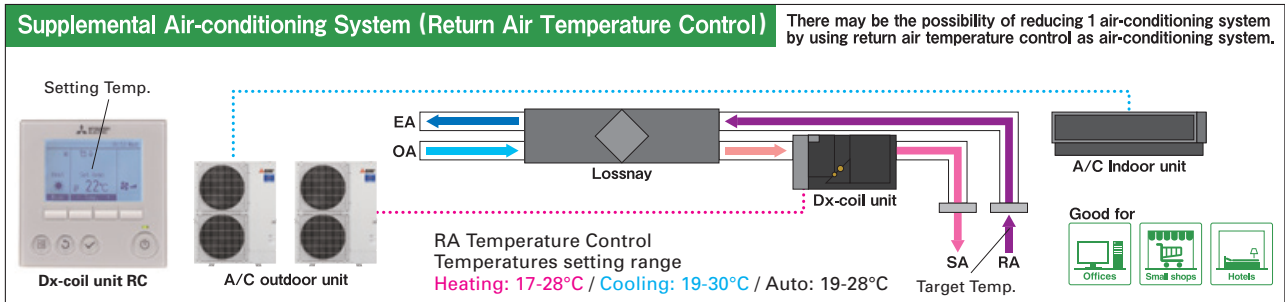

*Example images of using LGH-RVXT series for reference only.

Flexible Installation

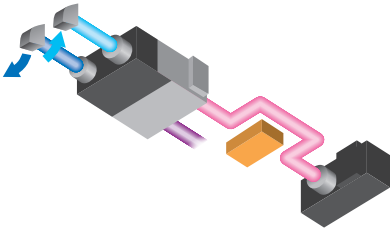

Flexible Connection to Lossnay

The length of the connection cable (accessory) between the Lossnay and Dx-coil unit is about 6m, so flexible installation is possible (two units can be installed close together or far apart with straight or bent ducting).

To Keep High Static Pressure

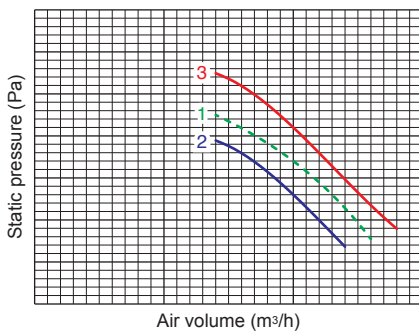

P-Q curve image

1. Lossnay unit
2. Lossnay unit + Dx-coil unit
3. Lossnay unit (fan power up +4) + Dx-coil unit

Dx-coil unit static pressure loss is kept to minimum, making it possible to maintain high static pressure using the fan power up function of the Lossnay. The fan power up function is only available when used with the PZ-61DR-E Lossnay remote controller.

Drain Pump Equipment

A built-in drain pump makes, attaching the drain hose in the ceiling cavity easy, resulting in simple and fast installation.

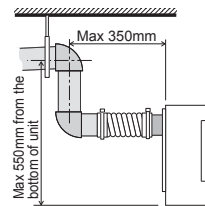

User-friendly System Control

Flexible Remote Controller Selection

(A) One remote controller

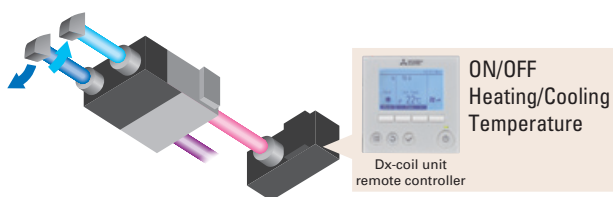

(B) Two remote controllers

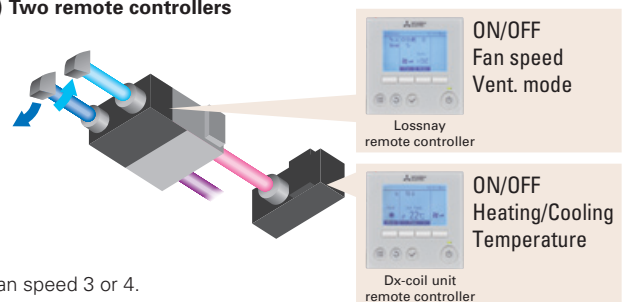

When using only one remote controller, the Lossnay fan speed is fixed at fan speed 3 or 4.

When using two remote controllers, all of Lossnay function is available.

*1: Both of Lossnay unit and Dx-coil unit will synchronously switch to ON and OFF.

*2: When one of the two remote controllers is turned ON, the other remote controller turns ON synchronously.

Priority Mode Selection

Temperature priority mode (factory setting) or Fan speed priority mode are selectable when Lossnay unit fan speed is controlled by a CO₂-sensor or a BMS (analogue input (0-10VDC) or a volt-free input).

*During fan speed 1 or 2, the Dx-coil unit is always thermo-OFF

Operation mode	Fan speed order from external input	Actual fan speed	
		Temp. priority	Fan speed priority
Heating or Cooling	FS4	FS4	FS4
	FS3	FS3	FS3
	FS2	FS3	FS2
	FS1	FS3	FS1
Fan	FS4	FS4	FS4
	FS3	FS3	FS3
	FS2	FS2	FS2
	FS1	FS1	FS1

Specifications

GUG Series

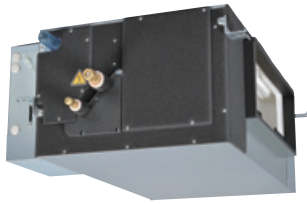

GUG-01SL-E



GUG-02SL-E



GUG-03SL-E

Model	GUG-01SL-E (Connection to LGH-50RVX-E or LGH-65RVX-E)								GUG-02SL-E (Connection to LGH-80RVX-E or LGH-100RVX-E)							
Refrigerant	R410A								R410A							
Electrical power supply	220-240V / 50Hz, 220V / 60Hz (Supplied from outdoor unit)								220-240V / 50Hz, 220V / 60Hz (Supplied from outdoor unit)							
Input power	Heating / Fan: 2.5W, Cooling: 12.4W								Heating / Fan: 2.5W, Cooling: 12.4W							
Running current	Less than 0.1A								Less than 0.1A							
Weight	21kg *Accessories: Approx. 1kg								26kg *Accessories: Approx. 1kg							
Function	Heating / Cooling / Auto / Fan *Auto is only available for RA temperature control								Heating / Cooling / Auto / Fan *Auto is only available for RA temperature control							
RA (Return Air) temperature control																
RA (Return Air) temperature control [Must be set at initial setting and not possible to change from remote controller]																
RA (Return Air) temperature control																
Connectable Lossnay unit																
Capacity [kW]																
SHF																
Performance index																
Air flow range at SP3 and SP4																
Connectable outdoor unit																
Ext. piping																
Required optional parts																
SA (Supply Air) temperature control																
Connectable Lossnay unit																
Capacity [kW]																
SHF																
Performance index																
Air flow range at SP3 and SP4																
Connectable outdoor unit																
Ext. piping																
Required optional parts																
Ventilation specifications																
Connectable Lossnay unit																
Fan speed																
Air Volume																
External static pressure [Pa]																

Model	GUG-03SL-E (Connection to LGH-150RVX-E or LGH-200RVX-E)								GUG-03SL-E (Connection to LGH-150RVXT-E, LGH-200RVXT-E or LGH-250RVXT-E)							
Refrigerant	R410A								R410A							
Electrical power supply	220-240V / 50Hz, 220V / 60Hz (Supplied from outdoor unit)								220-240V / 50Hz, 220V / 60Hz (Supplied from outdoor unit)							
Input power	Heating / Fan: 2.5W, Cooling: 12.4W								Heating / Fan: 2.5W, Cooling: 12.4W							
Running current	Less than 0.1A								Less than 0.1A							
Weight	28kg *Accessories: Approx. 1kg								28kg *Accessories: Approx. 1kg							
Function	Heating / Cooling / Auto / Fan *Auto is only available for RA temperature control								Heating / Cooling / Auto / Fan *Auto is only available for RA temperature control							
RA (Return Air) temperature control / SA (Supply Air) temperature control [Must be set at initial setting and not possible to change from remote controller]																
RA (Return Air) temperature control																
Connectable Lossnay unit																
Capacity [kW]																
SHF																
Performance index																
Air flow range at SP3 and SP4																
Connectable outdoor unit																
Ext. piping																
Required optional parts																
SA (Supply Air) temperature control																
Connectable Lossnay unit																
Capacity [kW]																
SHF																
Performance index																
Air flow range at SP3 and SP4																
Connectable outdoor unit																
Ext. piping																
Required optional parts																
Ventilation specifications																
Connectable Lossnay unit																
Fan speed																
Air Volume																
External static pressure [Pa]																

Characteristic Curves

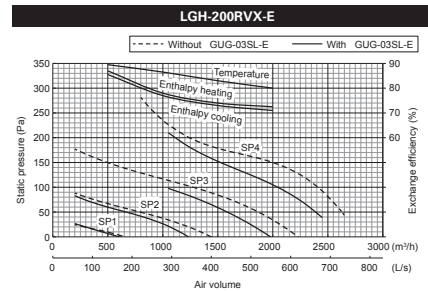
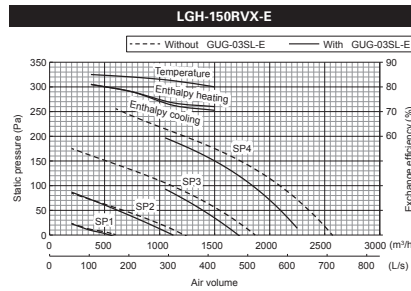
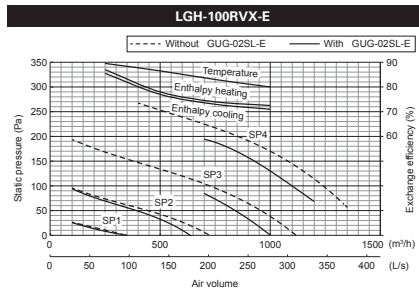
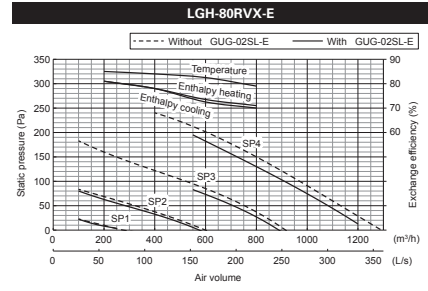
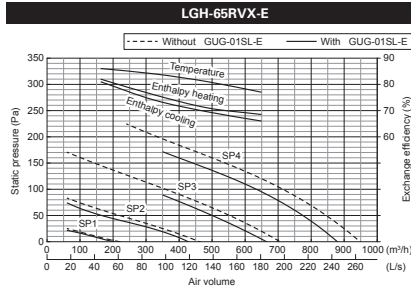
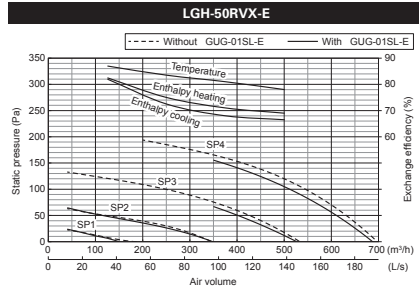

*Note The graphs below show the supply air only.

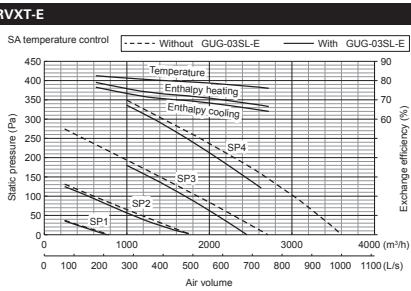
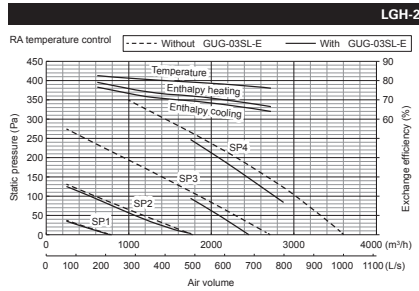
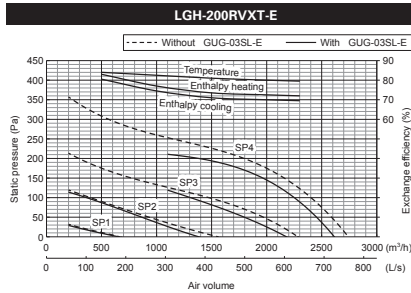
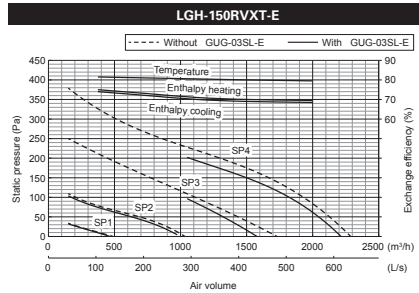

Attention

- The running current and input power are based on 230V/50Hz.
- The cooling and heating capacities are based on the air conditions listed below and the rated airflow of fan speed 4.
Cooling Indoor: 27°CDB/19°CWB Outdoor: 35°CDB/24°CWB
Heating Indoor: 20°CDB/15°CWB Outdoor: 7°CDB/6°CWB
- The first figure in () of the capacity specification is the heat recovery energy of the Lossnay unit. The second figure is the capacity specification for the Dx-coil connected to the outdoor unit.
- “Performance index” is the calculated value at the temperature conditions above and is reference purpose only.
Performance index = Total capacity ÷ total power consumption of outdoor unit and Lossnay unit
- The external static pressure listed in the tables includes the static pressure loss of the Dx-coil unit when using a 50cm straight duct between the Lossnay and Dx-coil units. When the duct work between the Lossnay and Dx-coil units is longer and/or bent, the pressure loss of the duct work should be included in the pressure loss calculation.
- The designed airflow of the system (Lossnay, Dx-coil and duct work) at fan speed 3 and 4 should be kept within “Airflow range at SP3 and SP4” listed in the tables. This range is shown as the solid line in graphs of the characteristics curve. If the Lossnay airflow is out of this range, the compressor of the outdoor unit may stop for self-protection purposes.
- By installing the Dx-coil unit with a Lossnay unit, the air blow noise level is quieter at fan speed 4.
Please refer to the “Direct Expansion coil unit for Lossnay” catalogue.
- Refrigerant leakage contributes to climate change. Refrigerant with lower global warming potential (GWP) would contribute less to global warming than a refrigerant with higher GWP, if leaked to the atmosphere.
This appliance contains a refrigerant fluid with a GWP equal to 1975. This means that if 1kg of this refrigerant fluid would be leaked to the atmosphere, the impact on global warming would be 1975 times higher than 1kg of CO₂, over a period of 100 years. Never try to interfere with the refrigerant circuit yourself or disassemble the product yourself and always ask a professional.

Residential Use Lossnay

Mitsubishi Electric offers you decentralized ventilation and centralized ventilation solutions for optimising your indoor air quality by Lossnay.

Decentralized Ventilation Solution

Install the wall mounted Lossnay in each room. The heat recovery system provides fresh air at a comfortable air temperature. Total heat exchangers effectively reduce heat loss.

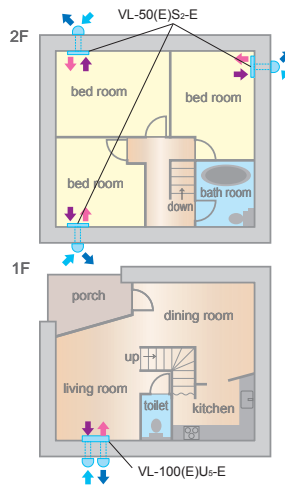
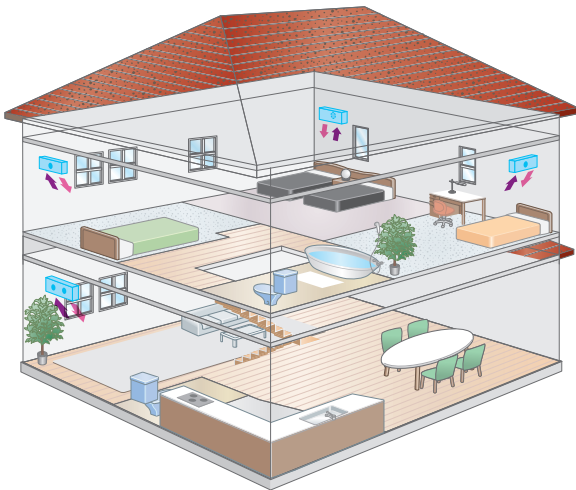

2F
Model:
VL-50(E)S₂-E
VL-50SR₂-E

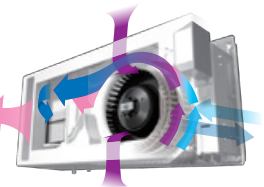

1F
Model:
VL-100(E)U₅-E

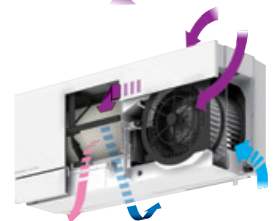

Centralized Ventilation Solution

One Lossnay unit provides 24-hour ventilation for the entire house, from living room and bedrooms to the bathroom. The heat recovery system provides fresh air at a comfortable air temperature. Sensible heat exchanger effectively reduces excess humidity in the winter.

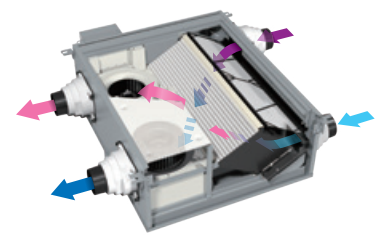
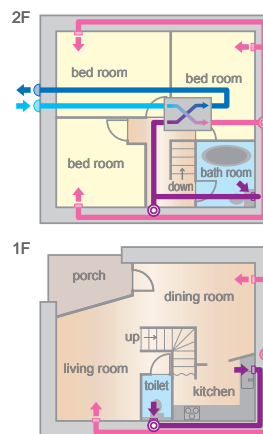
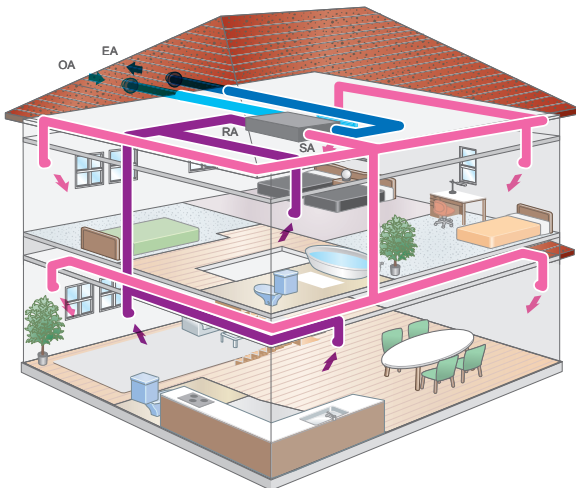

Model:
VL-220CZGV-E

Decentralized ventilation: VL-50(E)S₂-E, VL-50SR₂-E and VL-100(E)U₅-E

Product Merit

Air supplied and Exhausted Simultaneously

Supply and exhaust air simultaneously while transferring the heat.

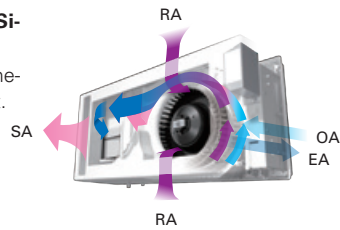

The low noise level is good for bedrooms and children's rooms.

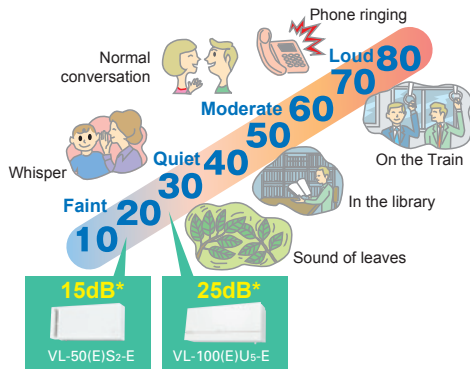

*Condition: 50Hz, 230V, low fan speed

Energy Efficient

- Total heat exchanger minimizes heat loss.
- Achieve over 80%* temperature efficiency.

*VL-10D(E)U₅-E at low fan speed in 230V 50Hz

*VL-50(E)S₂-E at low fan speed in 230V 50Hz

Sound Insulation

A sound insulation effect reduces noise generated outside.

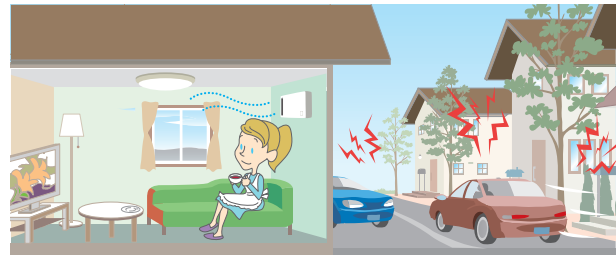

Sound Insulation Effect	Sound Source Side	Sound Receiving Side	Difference
	Average sound pressure dB	Average sound pressure dB	
	103.4	63.2	40.2

*Tested based on VL-08S₂-AE

*Measured by average sound pressure level of more than 30dB in 500Hz according to JIS A1416.

VL-08S₂-AE is Japanese dedicated model with equivalent of VL-50(E)S₂-E

Product Features

Stylish Design

Match any interior décor to create a comfortable room.



VL-50(E)S₂-E
VL-50SR₂-E



VL-100(E)U₅-E

Easy Maintenance

The only maintenance required is cleaning the outside-air filter and exhaust-air filter. Filters are easily accessible, making quick and thorough cleaning possible.

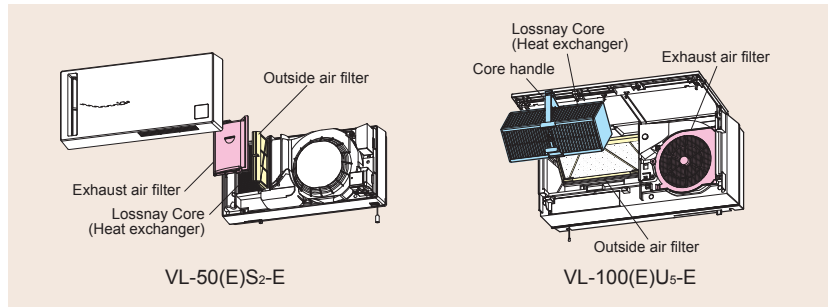

VL-50(E)S₂-E

VL-100(E)U₅-E

Flexible Installation for Only VL-50(E)S₂-E and VL-50SR₂-E

Not only horizontal installation but also vertical installation are available. It can fit various types of rooms with flexible installation.

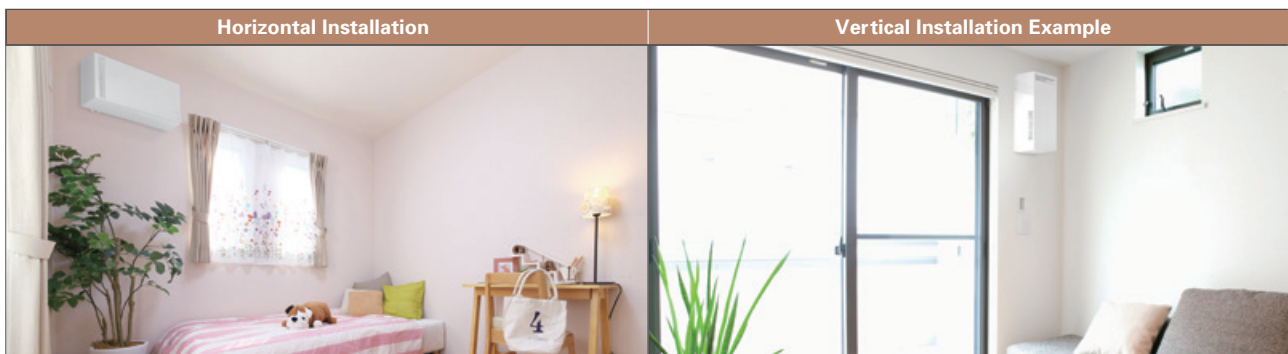

Horizontal Installation

Vertical Installation Example

Centralised ventilation: VL-220CZGV-E

Product Merit

Newly Developed Heat Exchanger

- During ventilation, Lossnay recovers warmth in the winter and keeps air cool in the summer.
- Reducing heating and cooling loads with a maximum exchange efficiency of 86%*.

Normal Square Heat Exchanger

Simple structure contributes to minimize pressure loss and reduce power consumption.

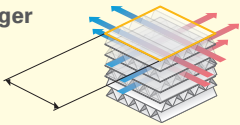

New Diamond Heat Exchanger

Due to the diamond design, air passages are longer and help realize higher exchange efficiency.

Wider Length

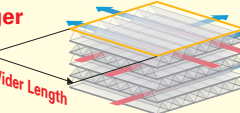

Energy Efficient

- The highest energy-saving performance in its class. (8.5W* minimum input power)
- Saves heating and cooling costs by minimizing energy loss that occurs during ventilation.



Quiet

- At an ultra quiet 14dB*, it is the quietest product in its class.
- Blocks outside noise for a more comfortable environment.



*Fan speed 1

Product Features

Fan Speed Precise Adjustment Function

Each main fan speed value can be further adjusted slightly. Use the PZ-61DR-E remote controller to adjust the speed.



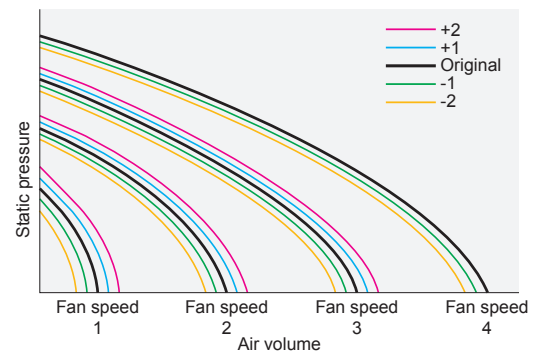

- 1) Considering the total hours of Lossnay operation (filter clogging), the fan power can be adjusted automatically after a given period of time.
- 2) After the unit is installed, when if the air volume is slightly lower or higher than the desired air flow, it is possible to make a fine adjustments. (Fan speed 4 is available only 1 down and 2 down)

P-Q curve image



Multi Ventilation (Power Supply and Exhausted) Mode

This mode allows the air supply/ exhaust balance to be varied dynamically. The supply/ exhaust balance can be selected to suit the usage environment.

Normal Mode	Power Supply Mode		Power Exhaust Mode	
Relax time 	Adjust the indoor pressure balance in case a separate exhaust is installed 	Increase indoor pressure to prevent unfiltered drafts from coming in 	Keep steam inside of the shower room 	Prevent odors from spreading 

Weekly Timer

Operation patterns for each day of the week. ON/OFF and airflow can be set using the weekly timer function (up to eight zones per day). This function contributes to enhanced energy-saving operation.

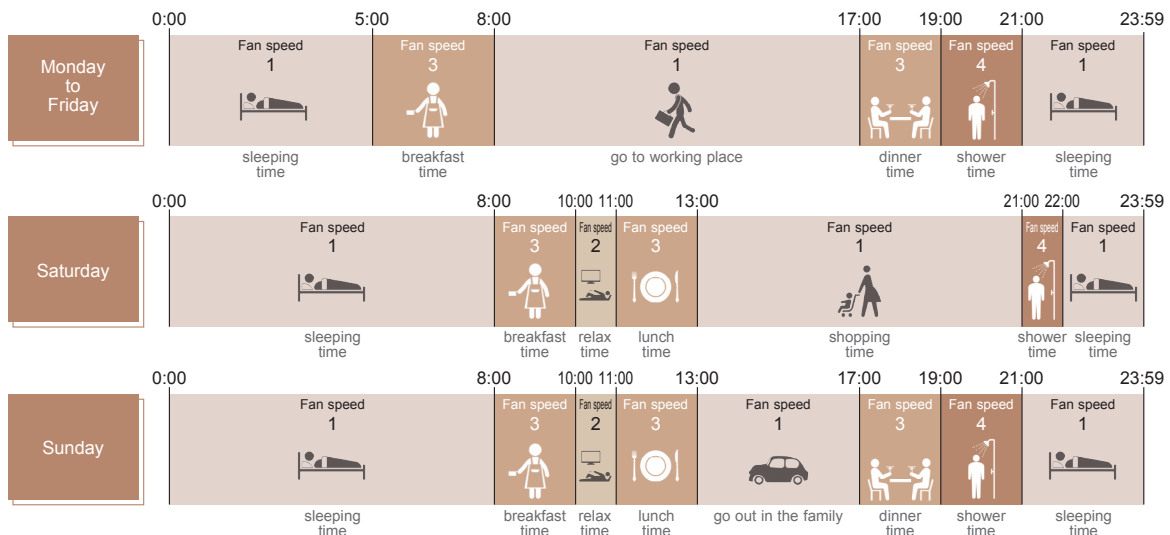

*Example for reference only.

Residential Lossnay Specifications

Model: VL-50S2-E (Pull-Switch Model), VL-50ES2-E (Wall-Switch Model)

Model	VL-50(E)S2-E							
	220V/50Hz		230V/50Hz		240V/50Hz		220V/60Hz	
Electrical power supply	220V/50Hz		230V/50Hz		240V/50Hz		220V/60Hz	
Fan speed	High	Low	High	Low	High	Low	High	Low
Air volume (m ³ /h)	51	15	52.5	16	54	17	54	17
Power consumption (W)	19	4	20	4.5	21	5	21	5.5
Temperature exchange efficiency (%)	70	86	69	85	68	84	68	84
Noise level (dB)	36.5	14	37	15	37.5	15.5	37.5	15.5
Weight (kg)	6.2							
Specific energy consumption class	C							

*Figures in the chart is measured according to Japan Industrial Standard (JIS B 8628) on shutter knob open position.

Dimensions

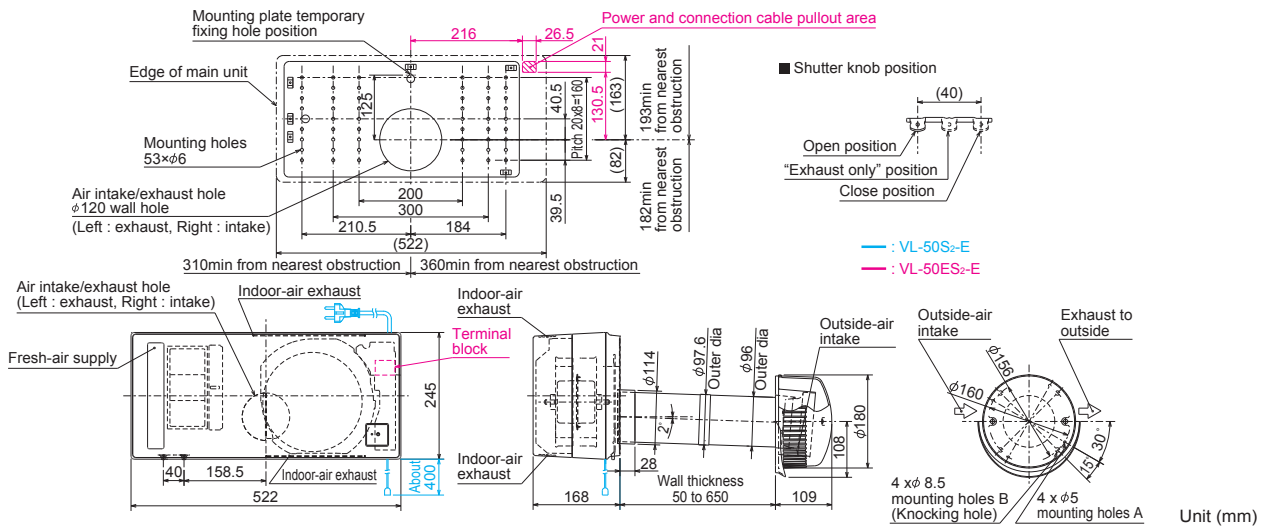

Model: VL-50SR2-E (Remote Controller Model)

Model	VL-50SR2-E							
	220V/50Hz		230V/50Hz		240V/50Hz		220V/60Hz	
Electrical power supply	220V/50Hz		230V/50Hz		240V/50Hz		220V/60Hz	
Fan speed	High	Low	High	Low	High	Low	High	Low
Air volume (m ³ /h)	51	15	52.5	16	54	17	54	17
Power consumption (W)	19	4.5	20	5	21	5.5	21	6
Temperature exchange efficiency (%)	70	86	69	85	68	84	68	84
Noise level (dB)	36.5	14	37	15	37.5	15.5	37.5	15.5
Weight (kg)	6.2							
Specific energy consumption class	C							

*Figures in the chart is measured according to Japan Industrial Standard (JIS B 8628) on shutter knob open position.

Dimensions

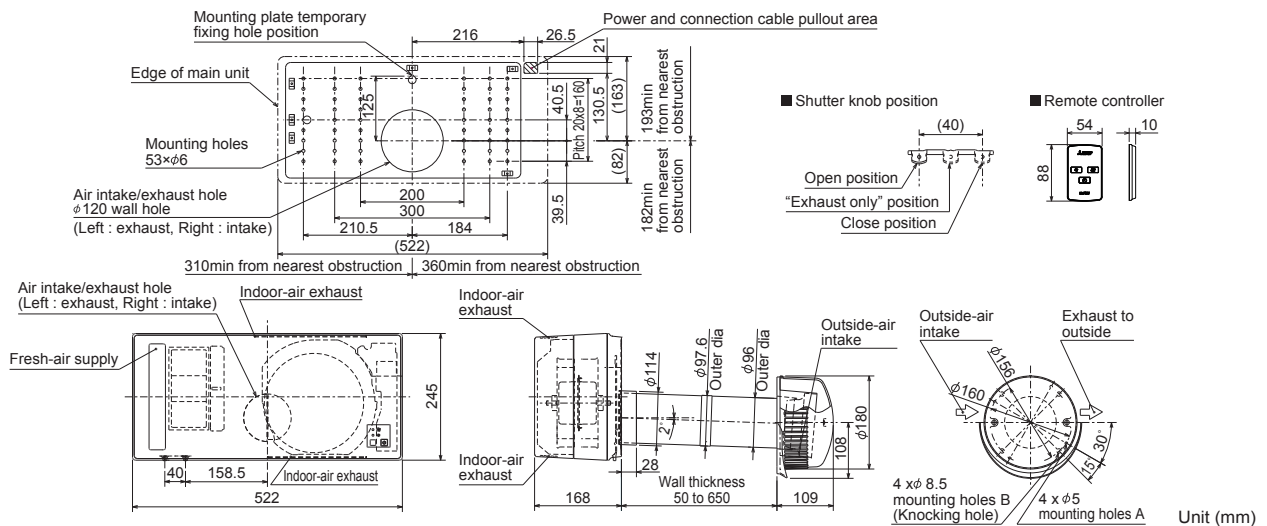

Model: VL-100U₅-E (Pull-Switch Model), VL-100EU₅-E (Wall-Switch Model)

Model	VL-100(E)U ₅ -E							
	220V/50Hz		230V/50Hz		240V/50Hz		220V/60Hz	
Electrical power supply	220V/50Hz		230V/50Hz		240V/50Hz		220V/60Hz	
Fan speed	High	Low	High	Low	High	Low	High	Low
Air volume (m ³ /h)	100	55	105	60	106	61	103	57
Power consumption (W)	30	13	31	15	34	17	34	17
Temperature exchange efficiency (%)	73	80	73	80	72	79	73	80
Noise level (dB)	36.5	24	37	25	38	27	38	25
Weight (kg)	7.5							
Specific energy consumption class	B							

*Figures in the chart is measured according to Japan Industrial Standard (JIS B 8628) on shutter knob open position.

Dimensions

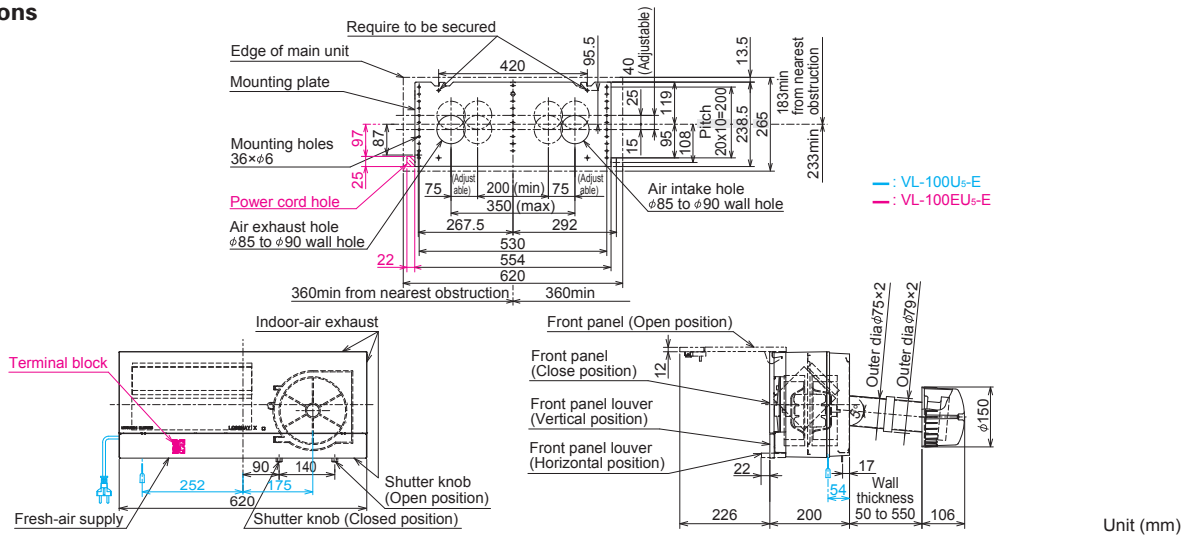

Model: VL-220CZGV-E

Model	VL-220CZGV-E			
	220-240V/50Hz 220V/60Hz			
Electrical power supply	220-240V/50Hz 220V/60Hz			
Ventilation mode	Heat recovery mode			
Fan speed	Fan speed 4	Fan speed 3	Fan speed 2	Fan speed 1
Running current	0.60	0.29	0.18	0.11
Input power (W)	80	35	18.5	8.5
Air volume	(m ³ /h)	230	165	120
	(L/s)	64	46	33
External static pressure (Pa)	164	84	44	13
Temperature exchange efficiency (%)	82	84	85	86
Noise level (dB)	31	25	19	14
Weight (kg)	31			
Specific energy consumption class	A			

*Figures in the chart is measured according to Japan Industrial Standard (JIS B 8628). Characteristic Curves are measured by chamber method.

Characteristic Curve

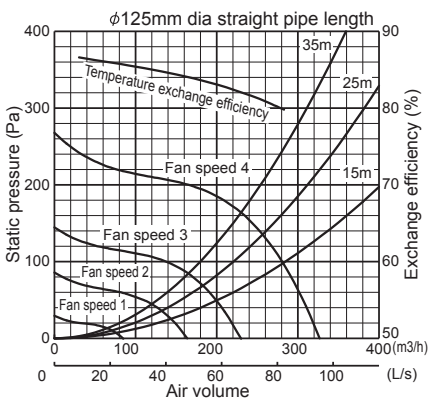



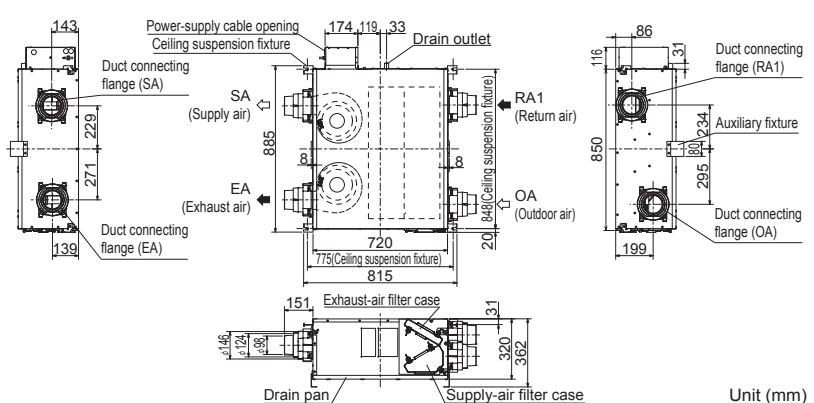

Dimensions



Accessories





Optional Parts for VL-50(E)S₂-E and VL-50SR₂-E

Filter, Extension Pipe and Stainless Hood

Type	High Efficiency Filter	Replacement Filter	Extension Pipe	Joint	Stainless Hood
Design					
Model	P-50HF ₂ -E	P-50F ₂ -E	P-50P-E	P-50PJ-E	P-50VSO ₅ -E
Feature	Upgraded high-performance filter.	Standard grade replacement filter.	Total length when connected to the joint is 350mm.	Joint for extension pipe	Stylish stainless hood

Optional Parts for VL-100(E)U₅-E

Filter and Extension Pipe

Type	High Efficiency Filter	Replacement Filter	Extension Pipe	Joint
Design				
Model	P-100HF ₅ -E	P-100F ₅ -E	P-100P-E	P-100PJ-E
Feature	Upgraded high-performance filter.	Standard grade replacement filter.	Total length when connected to the joint is 300mm.	<ul style="list-style-type: none"> Joint for extension pipe Screw-in method

Optional Parts for VL-220CZGV-E

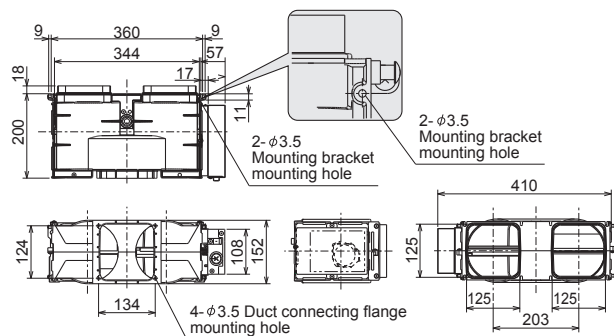

Bypass damper

Model: P-133DUE-E



Unit (mm)

Filter

Type	High Efficiency Supply Air Filter	Medium Efficiency Exhaust Air Filter	Standard Replacement Filter
Design			
Model	P-220SHF-E	P-220EMF-E	P-220F-E
Classification (EN779:2012)	M6	G4	G3

 NOTICE

- Do not install indoor units in areas (e.g. mobile phone base stations) where the emission of VOCs such as phthalate compounds and formaldehyde is known to be high as this may result in a chemical reaction.
- Our air-conditioning equipments and heat pumps contain a fluorinated greenhouse gas, R410A (GWP: 2088) or R32 (GWP: 675). *These GWP values are based on Regulation (EU) No.517/2014 from IPCC 4th edition. In case of Regulation (EU) No.626/2011 from IPCC 3rd edition, these are as follows. R410A (GWP: 1975), R32 (GWP: 550)
- When installing or relocating or servicing our air-conditioning equipment, use only the specified refrigerant (R410A or R32) to charge the refrigerant lines.
Do not mix it with any other refrigerant and do not allow air to remain in the lines.
If air is mixed with the refrigerant, then it can be the cause of abnormal high pressure in the refrigerant lines, and may result in an explosion and other hazards.
The use of any refrigerant other than that specified for the system will cause mechanical failure, system malfunction or unit breakdown. In the worst case, this could lead to a serious impediment to securing product safety.



for a greener tomorrow

Eco Changes is the Mitsubishi Electric Group's environmental statement, and expresses the Group's stance on environmental management. Through a wide range of businesses, we are helping contribute to the realization of a sustainable society.

MITSUBISHI ELECTRIC CORPORATION

HEAD OFFICE: TOKYO BUILDING, 2-7-3 MARUNOUCHI, CHIYODA-KU, TOKYO 100-8310, JAPAN
<http://Global.MitsubishiElectric.com/>

