

Comfort & IT Cooling Systems

Full product catalogue 2024

VRF & HVRF Systems, Heating, Ventilation,
Control Systems, Hydronic and IT Cooling Systems



LIVING ENVIRONMENTAL SYSTEMS

Comfort e It Cooling Systems

 **VRF System** 38-155

 **HVRF System** 156-215

 **Heating** 216-241

 **Ventilation** 242-273

 **Control Systems** 274-311

 **Applied Hydronic systems** 312-365

 **IT Cooling** 366-387

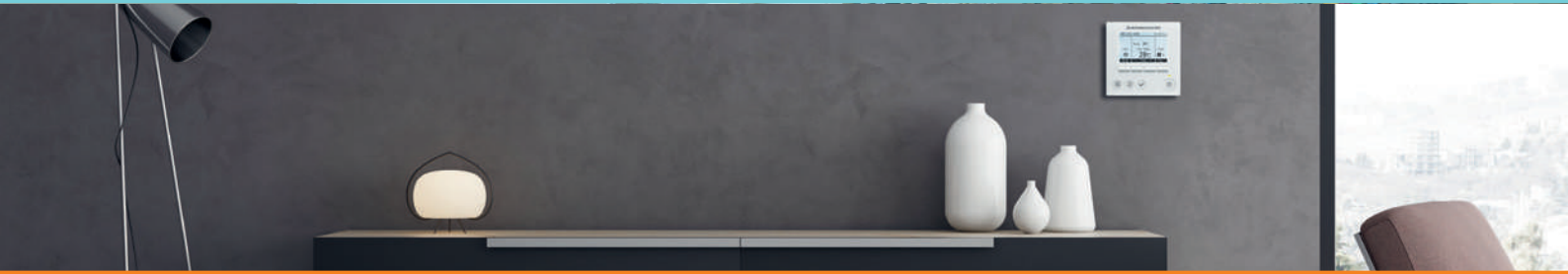



VRF-HVRF System CITY MULTI: innovation

New HOT WATER HEAT PUMP CAHV-R450YA-HPB

- Refrigerant system R454C Low-GWP refrigerant. The GWP of R454C refrigerant is 148. It is approximately 91% lower than the R407C refrigerant which is used in the conventional model (CAHV-P500YB-HPB)
- Multiple unit cascade control from 7.8kW to 640kW
- Achieves 70°C outlet temperature down to -2°C ambient temperature for continuous heating provision
- Multiple unit cascade control from 7.8kW to 640kW* capacity provides design flexibility for a wide range of commercial applications

New Indoor unit “Floorstanding type” PFFY-P VEM-E

New sophisticated design in clear white and pearl grey blends in with any interior.

Three installation options are available to suit a wide range of applications:

- Wall-mounted
- Freestanding
- Floorstanding

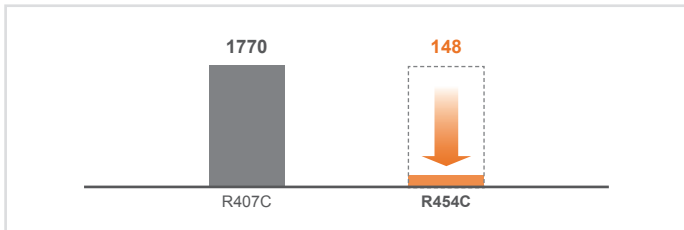

CITY MULTI	
CAHV-R450YA-HPB	NEW VRF INDOOR UNITS







VRF System

System types



SMALL Y AND SMALL Y COMPACT LINES
(SMALL SYSTEM)

Y LINE
(HEAT PUMP)

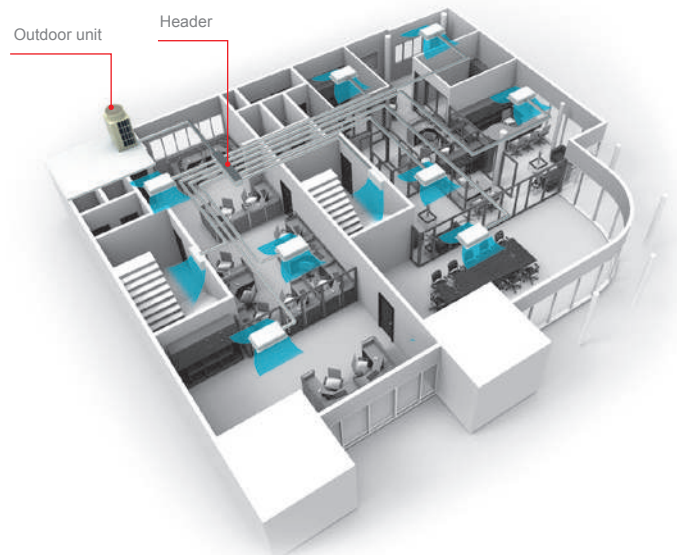
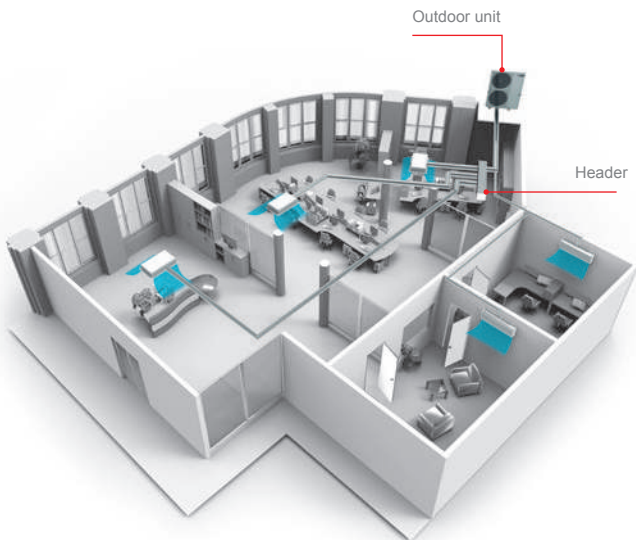

Y Line

The two-pipe zoned system designed for Heat Pump Operation

The CITY MULTI Small lines (for small applications) and Y lines (for large applications) make use of a two-pipe refrigerant system, which allows for system changeover from cooling to heating, ensuring that a constant indoor climate is maintained in all zones. The compact outdoor unit utilizes R410A refrigerant and an INVERTER-driven compressor to use energy effectively. With a wide line-up of indoor units in connection with a flexible piping system, the CITY MULTI series can be configured for all applications. Up to 11 (Small line) or 50 (Y line) indoor units can be connected with up to 130% connected capacity to maximize engineer's design options. This feature allows easy air conditioning in each area with convenient individual controllers.

Y ZUBADAN Line

Bringing a year round comfort solutions to extreme climates



CITY MULTI ZUBADAN-Series combines the ultimate in application flexibility and powerful cooling and heating capabilities to deliver precise comfort even in the coldest days of the year down to -30°C. The new ZUBADAN-Series that has new, larger-capacity compressors with an injection function in the suction chamber is capable of running at the rated heating capacity down to -20°C. In addition, the guaranteed outside temperature range of heating operation is expanded down to -30°C.

R2 Line

The world's first two-pipe system that Simultaneously Cools and Heats

CITY MULTI R2 line offers the ultimate in freedom and flexibility. Cool one zone while heating another. Our exclusive BC controller makes two-pipe simultaneous cooling and heating possible. The BC controller is the technological heart of the CITY MULTI R2 series. It houses a liquid and gas separator, allowing the outdoor unit to deliver a mixture of hot gas for heating and liquid for cooling, all through the same pipe. This innovation results in virtually no energy wasted by being expelled outdoors. Depending on capacity, up to 50 indoor units can be connected with up to 150% connected capacity.

Y LINE AIR CONDENSED HEAT PUMP

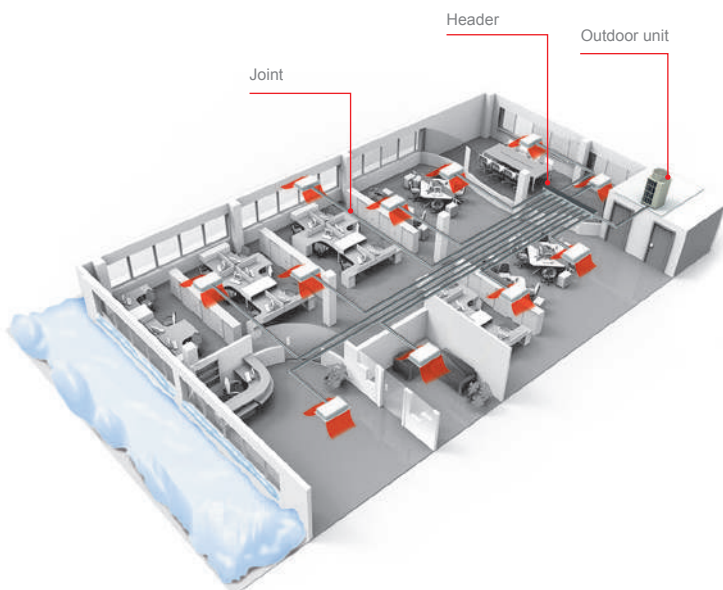

R2 LINE AIR CONDENSED RECOVERY HEAT PUMP SIMULTANEOUSLY HEATING AND COOLING

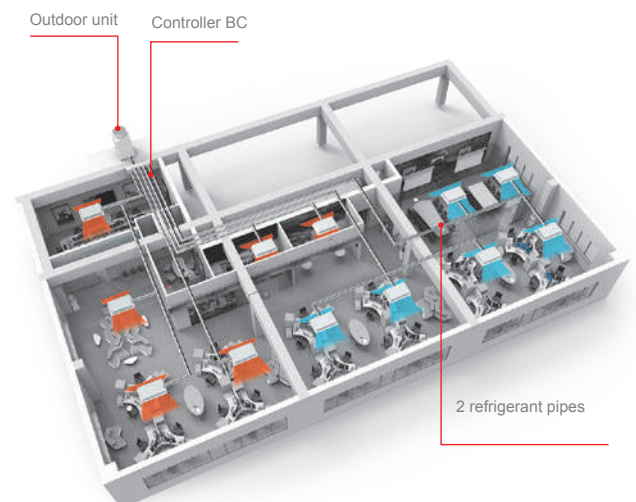

WY Line

Water energy source system allows switching between cooling and heating

The WY-Line has all the benefits of the Y-Series using water source condensing units. Condensing units can be situated indoors allowing greater design flexibility and no limitation on building size. Depending on capacity, up to 17 to 50 indoor units can be connected to a single condensing unit with individualized and/or centralized control. The two-pipe system allows all CITY MULTI solutions to switch between cooling and heating while maintaining a constant indoor temperature.

WR2 Line

Advanced water heat source unit enjoying the benefits of R2 series

The CITY MULTI WR2 line provides all of the advantages of the R2 series with the added advantages of a water heat source system, making it suitable for wider range of applications in high rises, frigid climates, coastal areas, etc. Not only does it produce heat recovery from the indoor units on the same 2-pipe refrigerant circuit, it also produces heat recovery via the water circuit between heat source units, making it a very economical system.

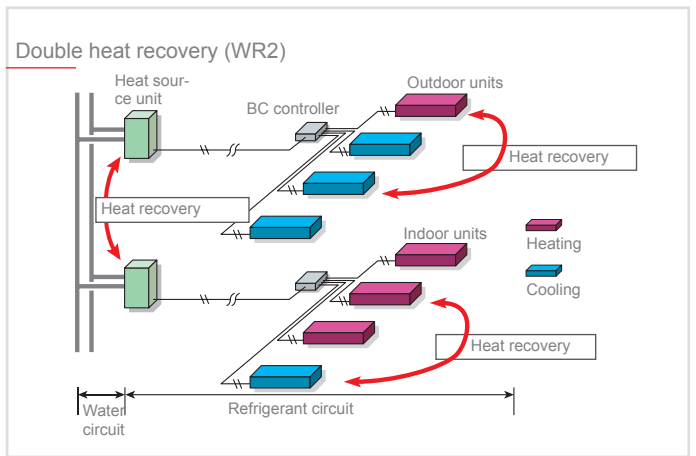



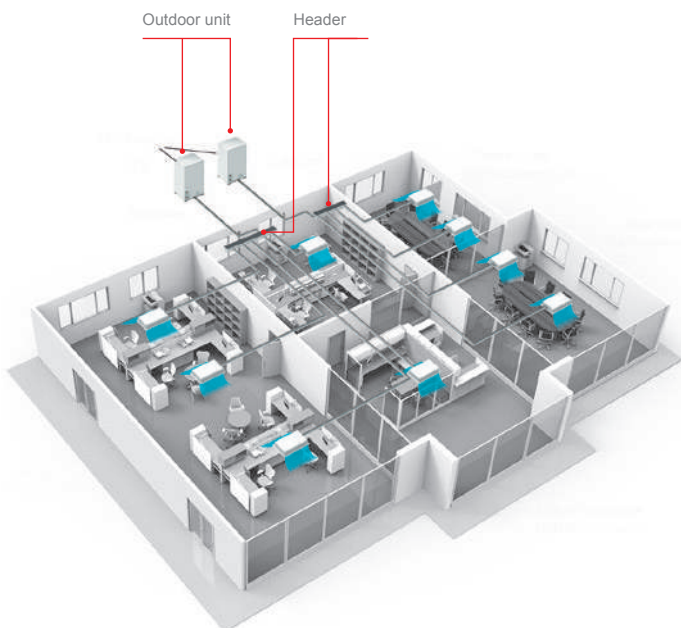

WY LINE
WATER CONDENSED HEAT PUMP

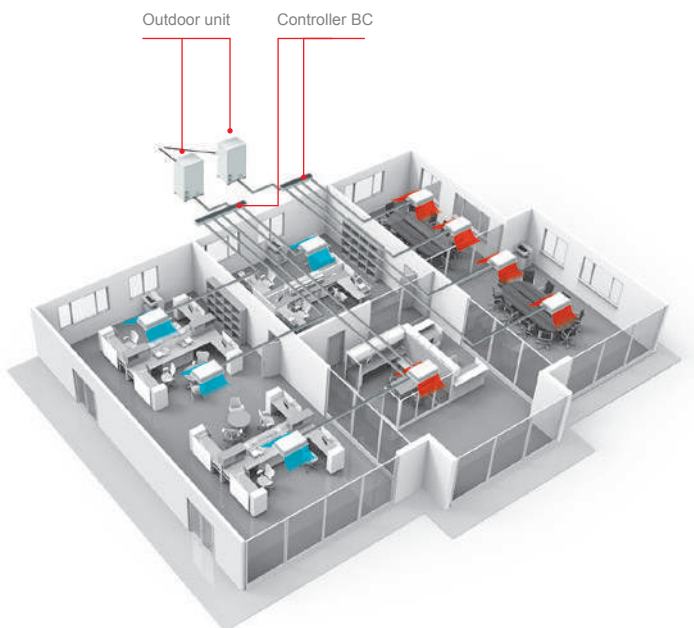



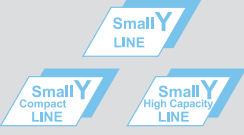













WR2 LINE SIMULTANEOUSLY HEATING AND COOLING WATER CONDENSED





	<p>CITY MULTI SMALL Y COMPACT R32 SYSTEM</p>	<p>Compact heat pump systems</p>
	<p>CITY MULTI SMALL Y SMALL Y COMPACT SYSTEM SMALL Y -HIGH CAPACITY- LINE</p>	<p>Compact heat pump systems</p>
	<p>CITY MULTI Y NEXT STAGE SYSTEM</p>	<p>Heat pump systems with continuous heating</p>
	<p>CITY MULTI Y NEXT STAGE HIGH EFFICIENCY SYSTEM</p>	<p>High efficiency heat pump systems with continuous heating</p>
	<p>CITY MULTI Y ZUBADAN SYSTEM</p>	<p>Heat pump systems optimized for cold climates</p>
	<p>CITY MULTI WY SYSTEM</p>	<p>Water condensed Heat Pump systems</p>
	<p>CITY MULTI R2 NEXT STAGE SYSTEM</p>	<p>Two-pipes Cooling / Heating simultaneous systems with heat recovery and continuous heating</p>
	<p>CITY MULTI R2 NEXT STAGE HIGH EFFICIENCY SYSTEM</p>	<p>High Efficiency two-pipes Cooling / Heating simultaneous systems with heat recovery and continuous heating</p>
	<p>CITY MULTI WR2 SYSTEM</p>	<p>Water condensed Heat Recovery systems</p>

		<p>SMALL Y COMPACT PUMY SM VMK(-BS) 4-5-6 HP SMALL Y COMPACT PUMY SM YMK(-BS) 4-5-6 HP</p>
		<p>SMALL Y COMPACT PUMY-SP YKM (-BS) - HP 4,5~6 PUMY-SP VKM (-BS) - HP 4,5~6 SMALL Y PUMY-P YKM (-BS) - HP 4,5~8 PUMY-P VKM (-BS) - HP 4,5~8 SMALL Y HIGH CAPACITY LINE PUMY-P YKM/YBM (-BS) - HP 10,12</p>
		<p>SINGLE Y PUHY-P YNW (-BS) - HP 8~20 DOUBLE Y PUHY-P YSNW (-BS) - HP 16~36 TRIPLE Y PUHY-P YSNW (-BS) - HP 38~54</p>
		<p>SINGLE Y PUHY-EP YNW (-BS) - HP 8~20 DOUBLE Y PUHY-EP YSNW (-BS) - HP 16~36 TRIPLE Y PUHY-EP YSNW (-BS) - HP 38~54</p>
		<p>SINGLE Y PUHY-HP YNW- HP 08~10 DOUBLE Y PUHY-HP YSNW - HP 16~20</p>
		<p>SINGLE WY PQHY-P YLM - HP 8~24 DOUBLE WY PQHY-P YSLM - HP 16~36</p>
		<p>SINGLE R2 PURY-P YNW (-BS) - HP 8~22 DOUBLE R2 PURY-P YNW (-BS) - HP 16~44</p>
		<p>SINGLE R2 PURY-EP YNW (-BS) - HP 8~22 DOUBLE R2 PURY-EP YNW (-BS) - HP 16~44</p>
		<p>SINGLE WR2 PQRy-P YLM - HP 8~24 DOUBLE WR2 PQRy-P YSLM - HP 16~36</p>

System		HP	4,5	5	6	8	10	12	14	16		
		Model	P112	P125	P140	P200	P250	P300	P350	P400		
Air condensed	Heat pump Small Y Compact Line R32	PUMY-SM Y(V)KM (-BS)		NEW	Single phase	4,5	5	6				
					Three phase	4,5	5	6				
	Heat pump Small Y Line Small Y Compact Line Small Y -High Capacity- Line	PUMY-P Y(V)KM (-BS) PUMY-SP Y(V)KM (-BS) PUMY-P YBM (-BS)		Single phase	4,5	5	6					
				Three phase	4,5	5	6	8	10	12		
	Heat pump Y Next Stage Line	PUHY-P YNW-A2(-BS) PUHY-P YSNW-A2(-BS)		SINGLE				8	10	12	14	16
				DOUBLE								8+8
				TRIPLE								
	Heat pump High Efficiency Y Next Stage Line	PUHY-EP YNW-A2(-BS) PUHY-EP YSNW-A2(-BS)		SINGLE				8	10	12	14	16
				DOUBLE								8+8
				TRIPLE								
Heat recovery R2 Next Stage Line	PURY-P YNW-A2(-BS) PURY-P YSNW-A2(-BS)		SINGLE				8	10	12	14	16	
			DOUBLE								8+8	
High Efficiency Heat recovery R2 Next Stage Line	PURY-EP YNW-A2(-BS) PURY-EP YSNW-A2(-BS)		SINGLE				8	10	12	14	16	
			DOUBLE								8+8	
Heat pump Y Zubadan Line	PUHY-HP YNW-A- HP PUHY-HP YSNW-A - HP		SINGLE				8	10				
			DOUBLE								8+8	
Water condensed	Heat pump WY Line	PQHY-P YLM-A1 PQHY-P YSLM-A1		SINGLE				8	10	12	14	16
				DOUBLE								8+8
	Heat recovery WR2 Line	PQRY-P YLM-A1 PQRY-P YSLM-A1		SINGLE				8	10	12	14	16
				DOUBLE								8+8

Technology

NEW

NEXT STAGE generation

New compressor NEXT STAGE GENERATION

The compressor, known as the heart of the air conditioner, has been newly developed. A new centrifugal force canceling mechanism and a new multi-port mechanism have been developed. In addition, we have mounted a high-efficiency motor. The synergetic effect of these new technologies increases the compressor performance and efficiency, and also helps to improve the performance of the outdoor unit.



Centrifugal force canceling mechanism (8 to 14HP)

The structure of the scroll compressor causes a centrifugal force during operation. Conventionally, that centrifugal force is applied onto the scroll section.

This causes refrigerant to leak, and restricts the increase in rotational speed to a maximum of 120rps.

With the new compressor, a new structure (centrifugal force canceling mechanism) has been mounted to suppress the centrifugal force. This mechanism successfully suppresses the centrifugal force generated at the scroll section, reduces refrigerant leakage losses, and increases the compressor efficiency. The maximum rotational speed has been increased from the conventional 120rps to 140rps.

This new mechanism also speeds up the start of operation, and enables operations such as preheat defrost operation and the smooth auto-shift startup mode.

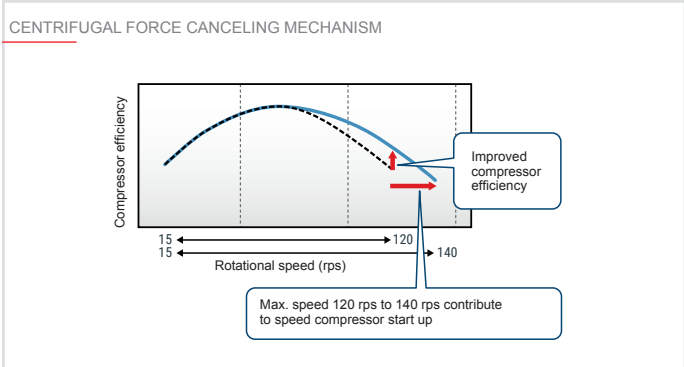
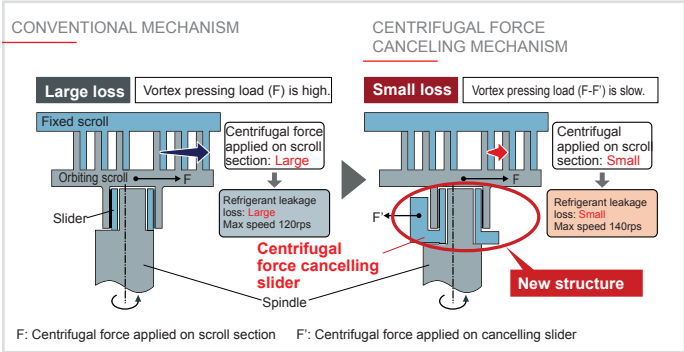

Multi-port mechanism

Efficient partial load operation is realised by avoiding over-compression. With the scroll compressor, the distance of the compression process in the scroll is usually fixed, so over-compression occurs during low loads and low rotation. The new compressor is equipped two sub-ports in addition to the conventional discharge port to reduce this over-compression loss during low loads. In operation conditions having a low compression rate, the distance in the compression process is kept short by that successfully avoiding unnecessary compression, and contributing to efficient partial load operation.

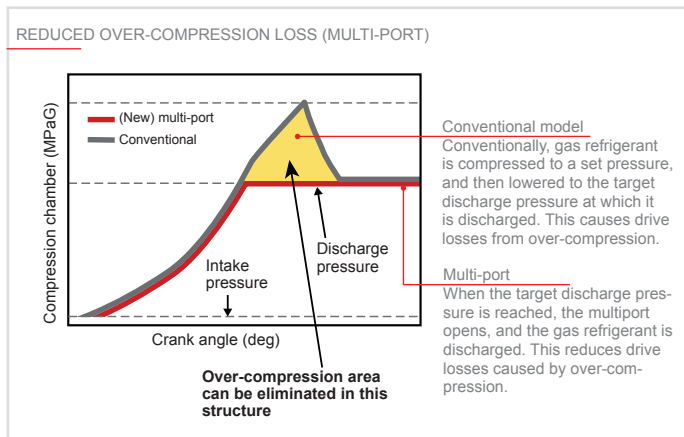
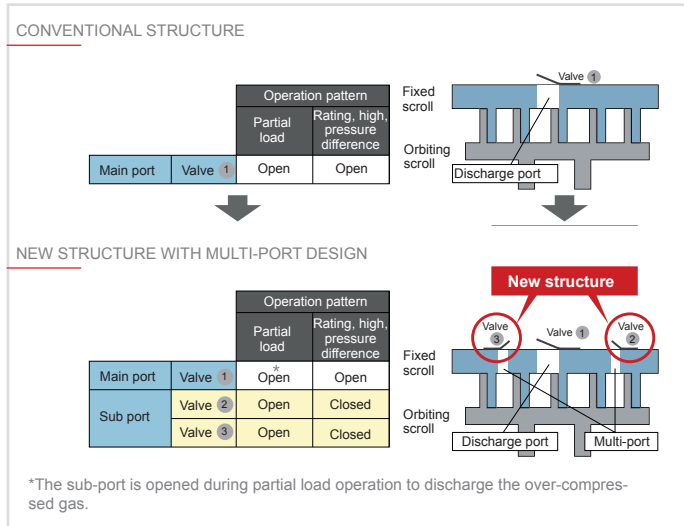

Improved high-efficiency motor

The insulator section that traditionally created a dead space is eliminated by insulating the motor's stator film. Since winding can be set in that section, the winding area can be increased by approx. 9%. The wire diameter has also been increased by two ranks, so the resistance between terminals is reduced, and the insulation distance is shorter. This improves the motor's operation performance and contributes to high-efficiency operation of the compressor.

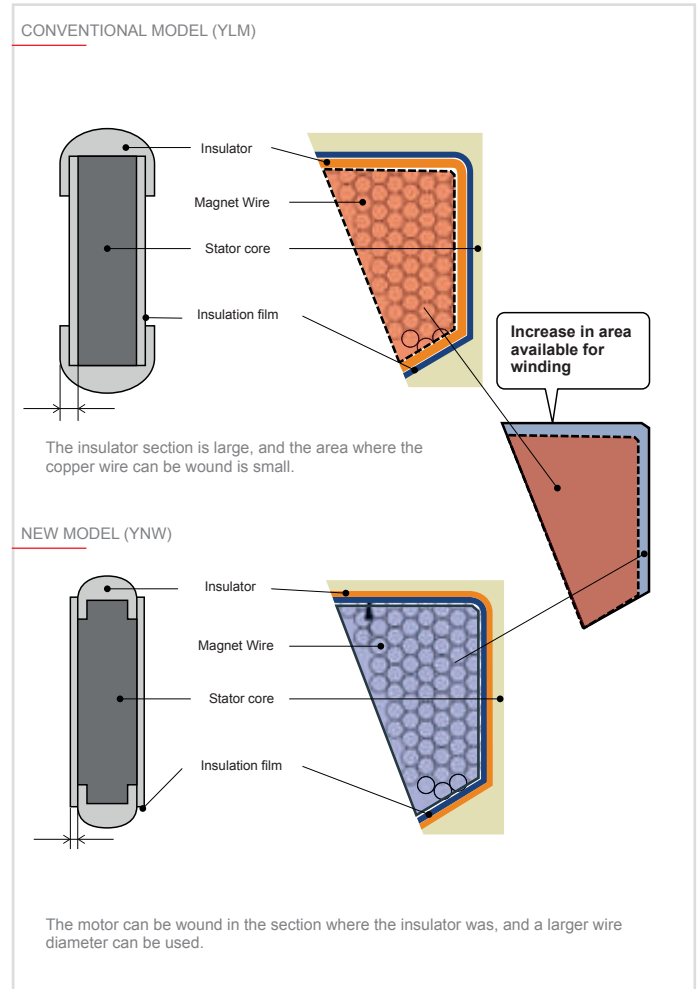

Flat tube

FLAT TUBE thermal exchange coil

With the new **Y High Efficiency and R2 High Efficiency lines** of outdoor units, Mitsubishi Electric has also introduced the new FLAT TUBE all-aluminium thermal exchange coil. The new solution, which is covered by global patents, sets new standards for heating and cooling performance while also reducing the overall size of the machine.

The FLAT TUBE technology coil – also known as a “micro-channel heat exchanger” – consists of three components: the flat tubing, the internal fins forming the micro-channels, and two refrigerant fluid collector boxes.

This type of heat exchanger was used for the first time in around 2008 in the automotive industry. With its globally patented FLAT TUBE system, Mitsubishi Electric has further developed this technology to offer even more advantages.

Unparalleled quality, efficiency and product integrity are the tangible results of a production process based on a single brazing stage instead of the 200-300 manually brazed individual connections necessary with a conventional copper/aluminium coil. Moreover, the FLAT TUBE heat exchanger requires a smaller

charge volume than a conventional bi-metal coil, as the microchannels limit the available volume for the refrigerant fluid while also creating a larger thermal exchange surface area.

Weather resistance is a key factor for the heat exchanger coil, as it is perhaps the component that is most exposed to the harmful effects of the atmosphere.

Here too, the **FLAT TUBE** coil outperforms other solutions: the single component in aluminium only is far less susceptible to corrosion than a conventional bi-metal coil in copper and aluminium. As if that were not already enough, the direct expansion coil of the new **Y High Efficiency and R2 High Efficiency lines** outdoor units receive a special galvanic treatment with **sacrificial zinc anodes** to further prevent any possibility of corrosion, while a **waterproofing treatment** protects the copper pipes connecting the heat exchanger coil to the refrigeration circuit against electrolytic corrosion. A special version (denominated -BS) may be ordered for installations in highly saline conditions or coastal zones, which is specifically designed for these applications.

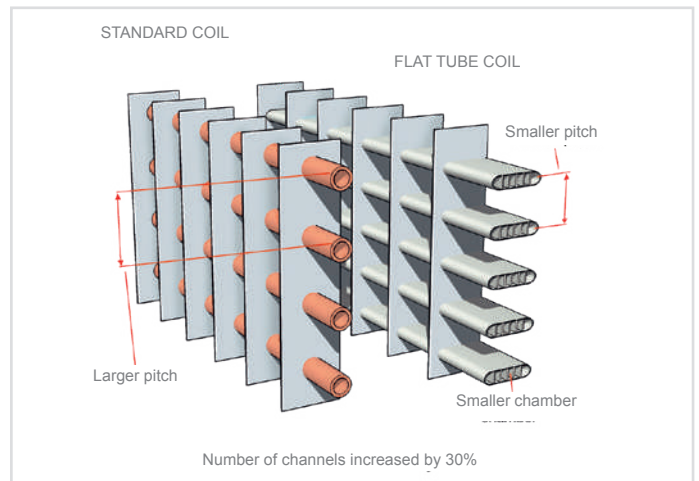

- ➔ +30% more piping
 - ➔ +17% more Contact with Piping
 - ➔ +26% more Contact with Refrigerant
 - ➔ Smaller Pitch and Pipe Chamber
 - ➔ Reduced Refrigerant Volume
- A world first for VRF systems**

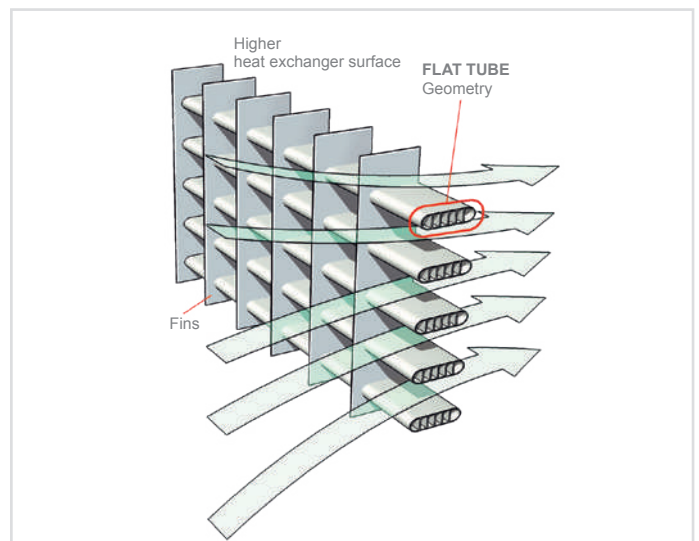



Inverter-driven compressor technology

All CITY MULTI compressors are of the inverter-driven type, capable of precisely matching a building's cooling and heating demands.

The compressor varies its speed to match the indoor cooling or heating demand and therefore only consumes the energy that is required. When an inverter driven system is operating at partial load, the energy efficiency of the system is significantly higher than that of a standard fixed speed, non-inverter system.

The fixed speed system can only operate at 100%, however, partial load conditions prevail for the majority of the time. Therefore, fixed speed systems cannot match the annual efficiencies of inverter driven systems. Using proven single inverter driven compressor technology, the CITY MULTI range is favored by the industry for low starting currents (just 8 amps for a 20HP outdoor unit) and smooth transition across the range of compressor frequencies.

HEATING / COOLING CAPACITY

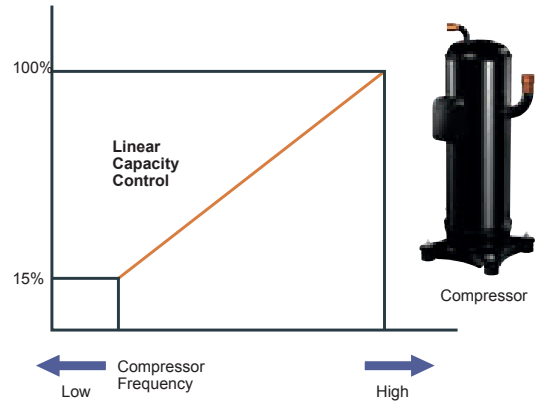

STABLE AND SMOOTH OPERATION

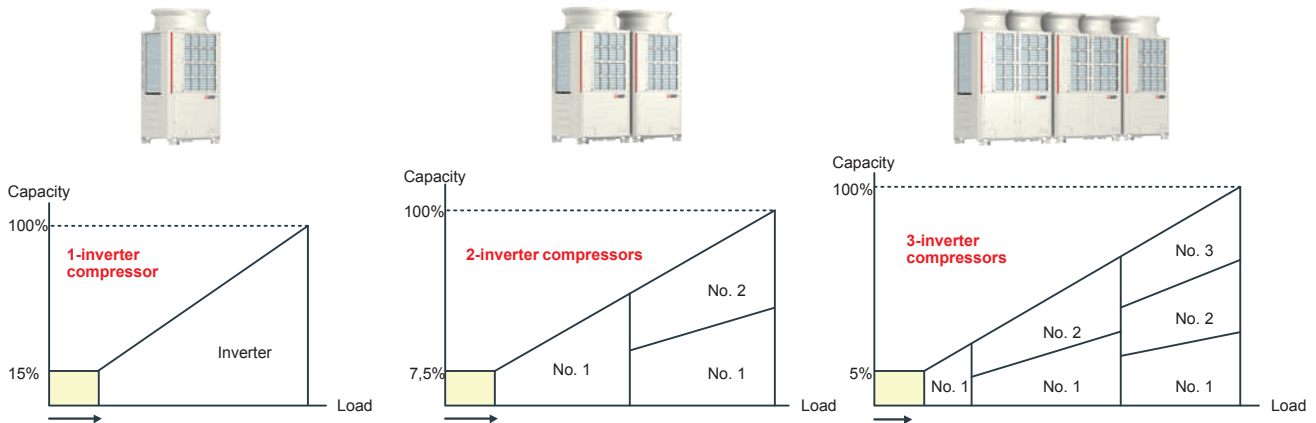

Heat recovery system

Comparison between different systems with different pipe connection points

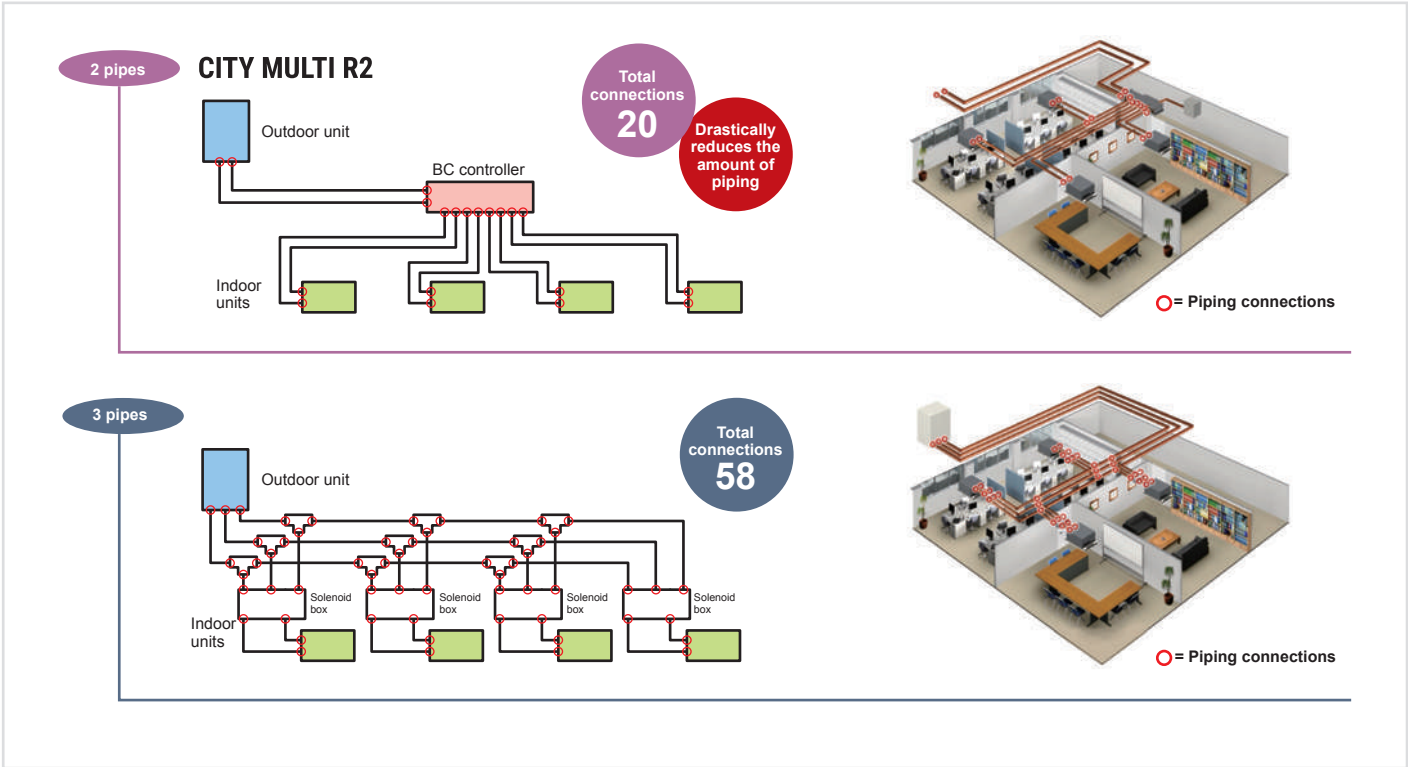

How does the R2 / WR2 heat recovery system work with two pipes?

The secret of the VRF CITY MULTI heat recovery system lies in the BC controller. The BC controller contains a liquid/gas separator which allows the outdoor unit to produce a two-phase mixture of hot gas for heating and liquid for cooling delivered through the same pipe. Three pipe systems use one pipe for

each of these two phases. The mixture is separated when it reaches the BC controller, and the correct phase (gas or liquid) is sent to each indoor unit in relation to individual demand for heating or cooling.

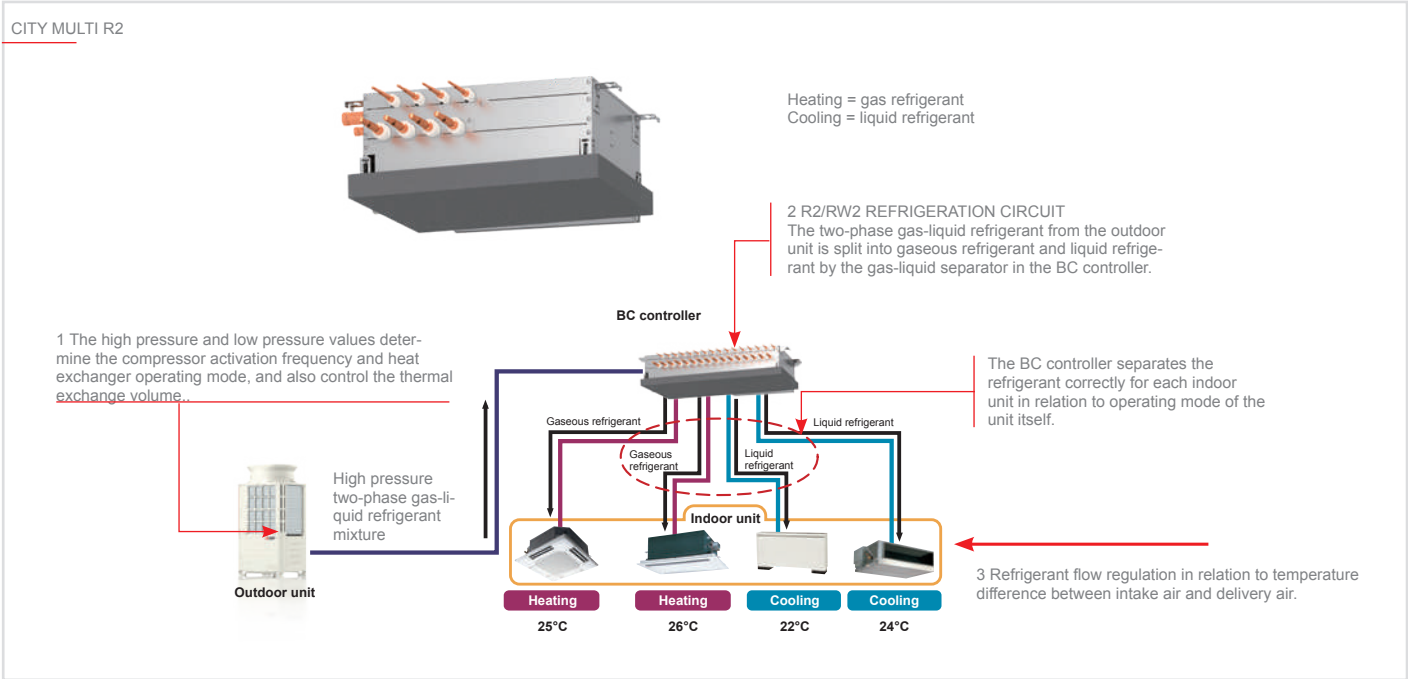

Heat recovery system

With the heat recovery system, the more often the simultaneous cooling and heating function is used, the greater the energy savings.

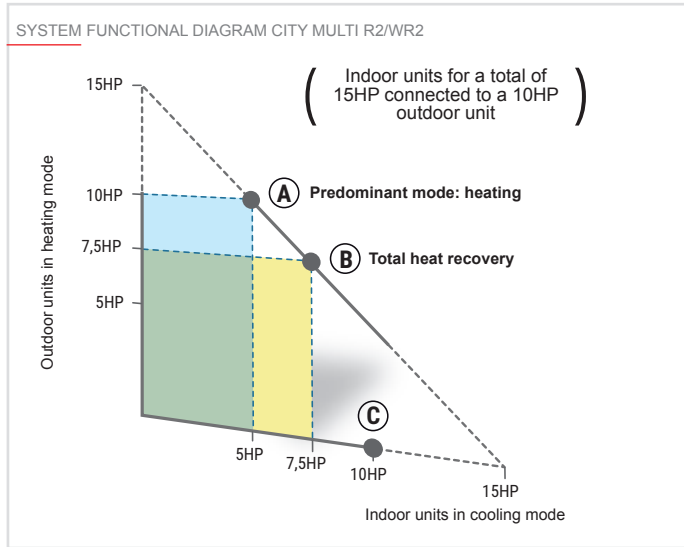

Why use heat recovery?

Flexibility and efficacy are decisive factors when choosing a system with heat recovery capability. For instance, while a heat pump system is suitable for an office with a large open space plan, in an office space subdivided into more units, a system is needed that can simultaneously heat and cool different zones in accordance with the preferences of each individual user. The efficacy of these systems stems from their ability to use by-products of cooling and heating to transfer energy where it is needed, therefore functioning as a balanced heat exchanger offering savings of up to 20% in operating costs compared with a conventional heat pump system. Moreover, the number of connection points needed for an R2 / WR2 system is significantly lower than the number required by a three pipe system. This reduces installation costs, further adding to the savings offered by using the VRF CITY MULTI system.

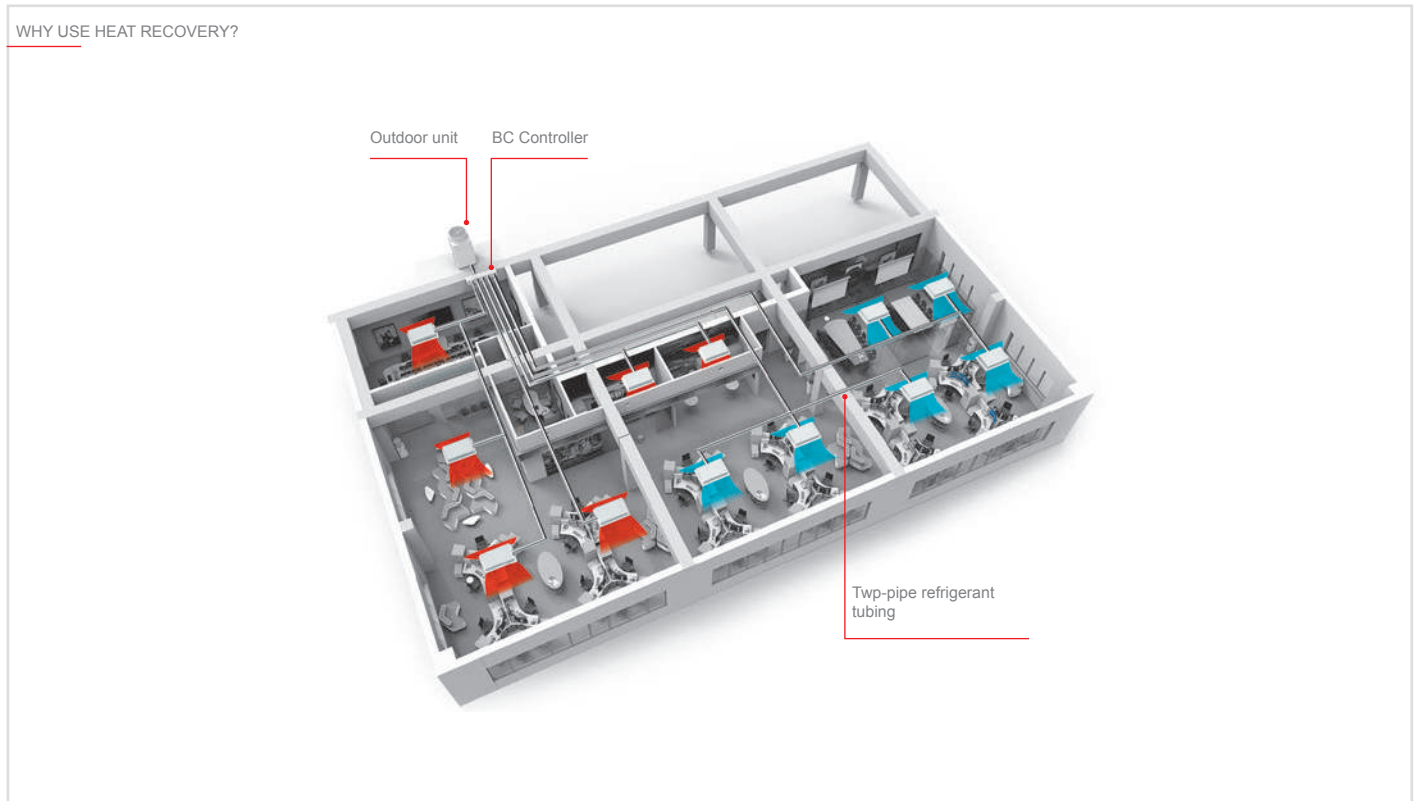

The LEV Kit system

The LEV Kit makes it possible to use the indoor units of Residential Line – which represent the state of the art in Mitsubishi Electric air conditioning system design – together with



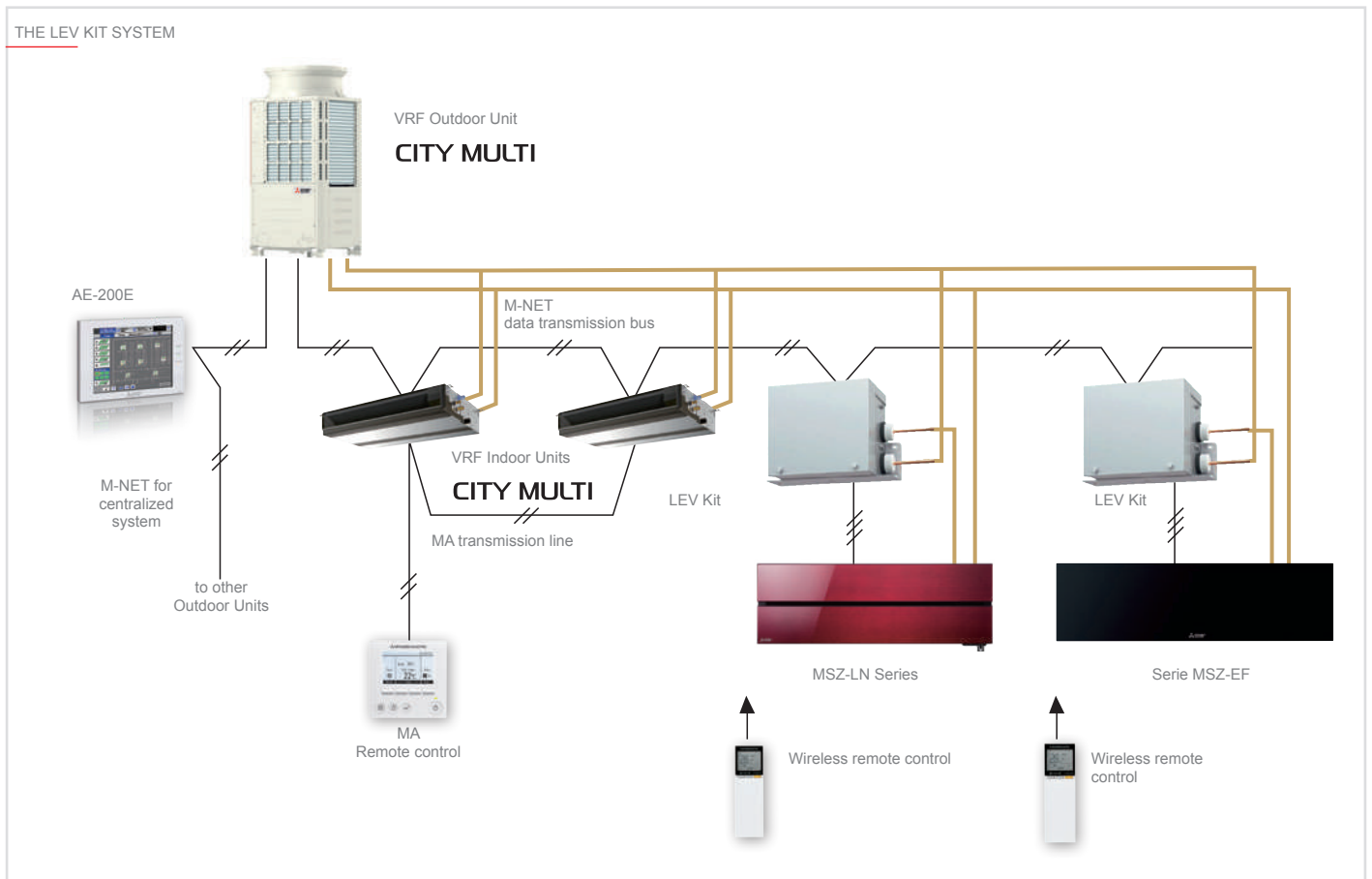



VRF CITY MULTI systems. Mixed installations can therefore be created with complete freedom.



The Mitsubishi Electric external units compatible with the LEV Kit are:

- Small Y Line
- Small Y Compact Line
- Small Y High Capacity Line
- Y Next Stage Line
- Y Zubadan Line
- Y Next Stage High Efficiency Line
- R2 Next Stage Line
- R2 Next Stage High Efficiency Line
- WY Line
- WR2 Line



Types and Sizes available Residential indoor units	15	18	20	22	25	35	42	50
MSZ-LN_VG(2) 		•			•	•		•
MSZ-AP_VG(K) 	•		•		•	•	•	•
MSZ-EF_VE/VG 		•		•	•	•	•	•
MSZ-SF_VAVE3 	•		•	•	•	•	•	•
MFZ-KJ_VE 					•	•		•
MFZ-KT_VG 					•	•		•

ATTENTION!!
FOR DETAILS ON COMPATIBILITY BETWEEN EACH MODEL OF INDOOR UNITS AND OUTDOOR UNITS PLEASE CONTACT YOUR LOCAL DISTRIBUTOR

Functions

M-NET Power

With the M-Net transmission line and the use of separate power and control circuits for indoor units, the following states can be identified automatically:

- indoor unit malfunction
- power loss to indoor unit

In the event of one of these conditions, the outdoor unit isolates the malfunctioning indoor unit or indoor unit receiving no power to ensure the continued electrical and refrigeration functionality of the system with no action required from a technician and/or a system administrator. This allows total flexibility in planning and laying out 220V AC power circuits, without the need for shared main lines and without requiring any additional devices to attain compliance with legislation for electrical systems. This circuit configuration is essential for situations where the system itself is shared by multiple owners or tenants, and where each must be able to electrically isolate their respective indoor terminal sections when required.

Continuous operation

In the event of power loss or partial malfunction of one or more indoor units, the system continues to function uninterruptedly and without requiring any action from a technician and/or system administrator.

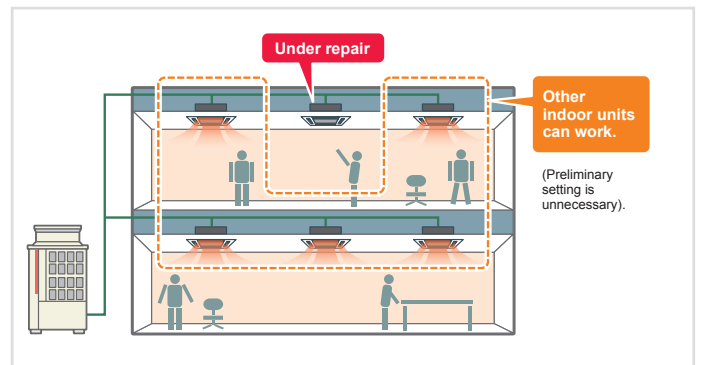
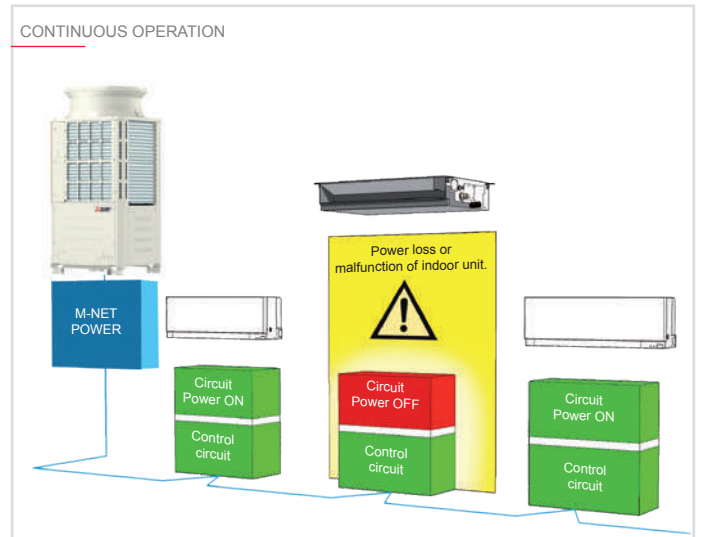

Continuous heating operation

Normally, it is necessary to stop the heating operation during defrosting. However, the continuous heating operation method makes it possible to perform defrosting while the heating operation continues.

Reduction in the stoppage time of the heating operation prevents drops in room temperature.

Use a dip switch on the outdoor unit to switch between the continuous heating operation method and the conventional defrosting method.

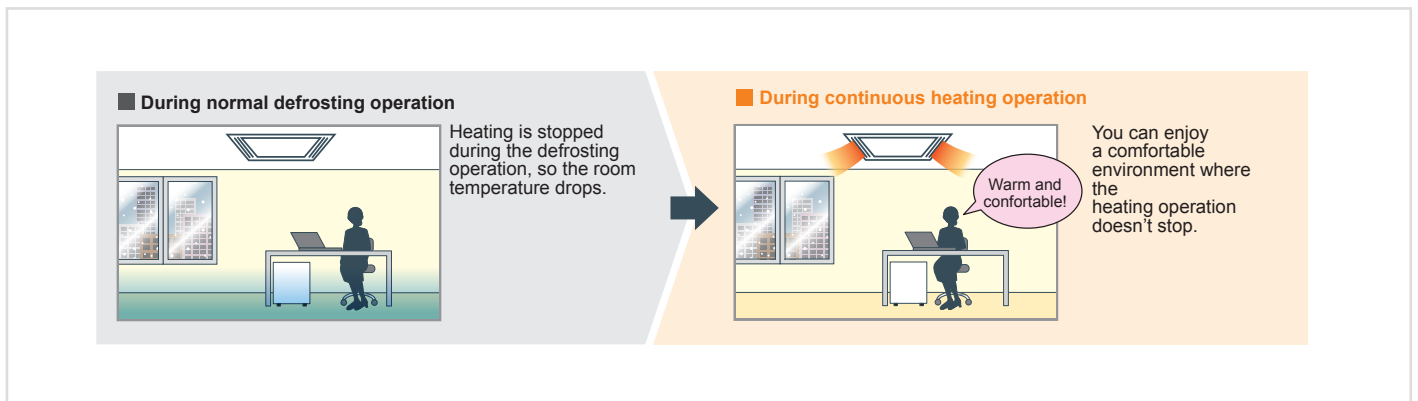

Continuous heating operation image (single unit)

The heat exchanger of the outdoor unit is split into parts. Even when defrosting is necessary, the heating operation is continued with a part of the heat exchangers.

Continuous heating operation image (combination)

With the combination model, units perform defrosting alternately. While one unit is performing defrosting, the other continues heating.

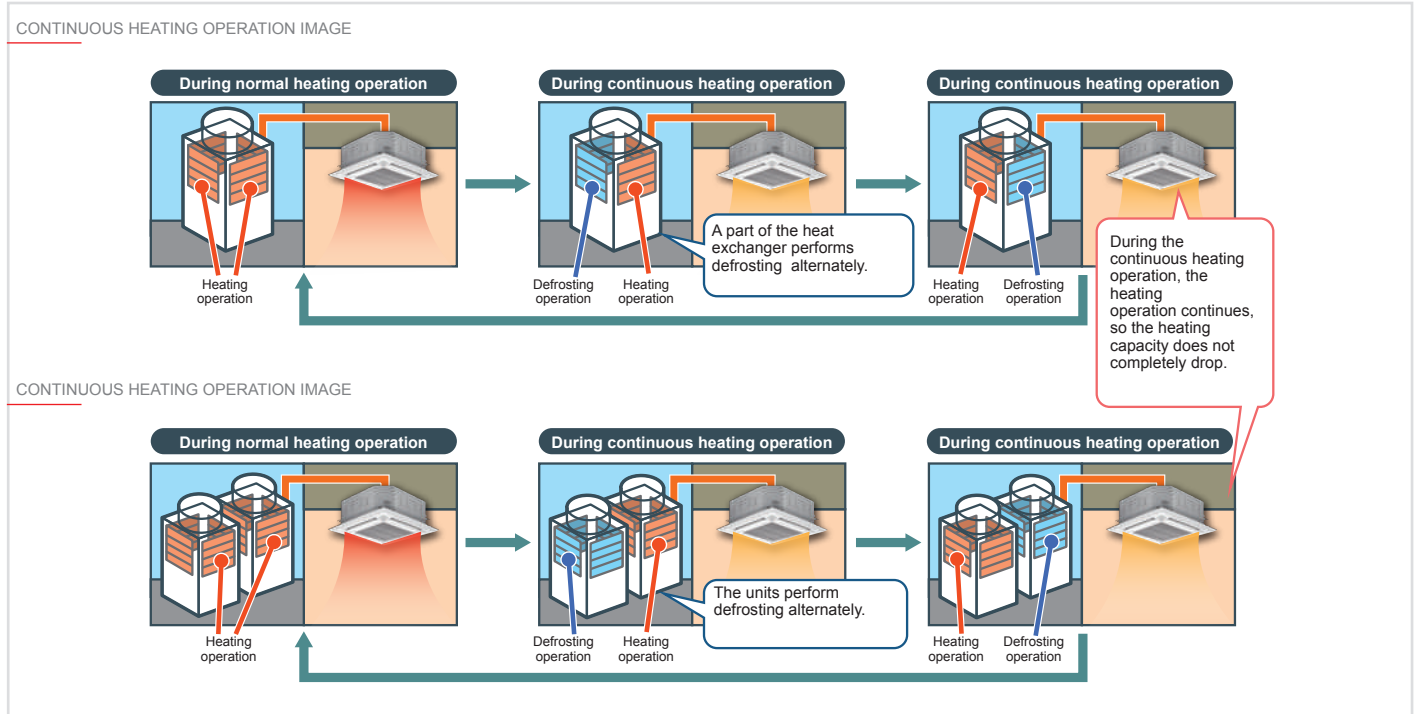

Preheat defrost operation

The new outdoor unit is equipped with a preheat defrost operation that raises the discharge temperature of the air before beginning defrost operation. This contributes to raising the room temperature before the start of defrost operation and prevents room occupants experiencing a chilling sensation.

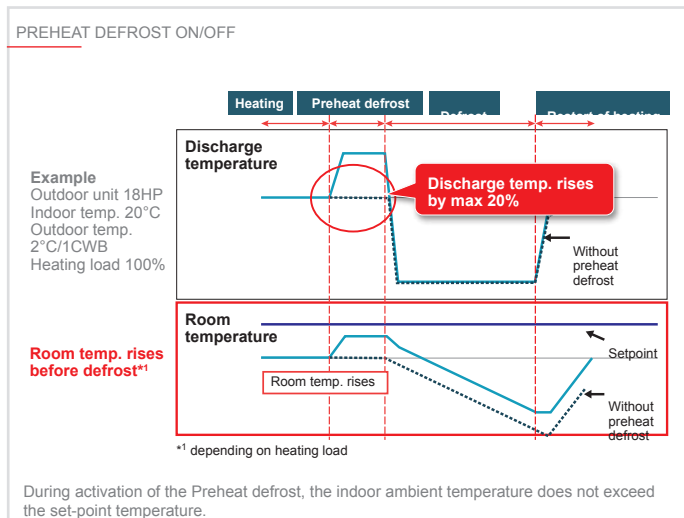

Flexible Noise Setting

The "Low Noise" mode, which conventionally only had one pattern, has been increased to four patterns so that a mode can be selected from a total of five patterns, including the rated pattern. The low-noise mode has four patterns 85%, 70%, 60% and 50% in respect to the fan speed. This can be set with the outdoor unit's DIP switch. The pattern can be selected according to the customer's requests when low-noise operation is required.

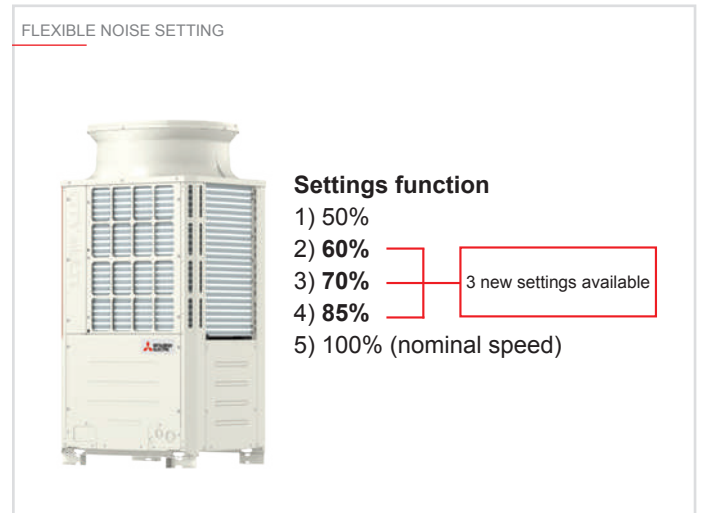

200% extended connectivity system

The innovative Ecodan® HWS unified VRF system by Mitsubishi Electric for domestic hot water production brings VRF technology to the heating market.

To ensure correct power usage in applications such as centralized residential systems and hotels, where permitted by the coincidence factor, Mitsubishi Electric offers a system allowing up to 200% extended connectivity.

The 200% extended connectivity system offers the advantage of simplified, intuitive and, most importantly, automated operation comparable to a conventional centralized heating system (e.g. gas boiler), meaning that the professional installer is no longer required to include complicated, redundant management and adjustment systems.

System architecture

For example, in a hypothetical installation with a P200 outdoor unit, this system permits the connection of units with a total power index equal to 200% that of the outdoor unit (P400), subdivided according to the following rules:

- Maximum power index for hydronic modules = P200 (100% of outdoor unit power index)

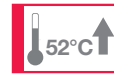

Extension of operating limit in Cooling to 52°C

In certain types of installation and in areas with high building density the passage of air can be obstructed. In very high outdoor temperature conditions and if the air expelled by the unit's fan is not correctly removed, it can stagnate and increase the air temperature around the machine. Thanks to an extended operating range of up to 52°C, the system can operate uninterruptedly even in these conditions.

- Maximum power index for indoor modules = P200 (100% of outdoor unit power index)

A VRF Ecodan® installation with this configuration will ensure simultaneous operation up to a power index of 150% in the case of an R2 heat recovery simultaneous heating and cooling system.

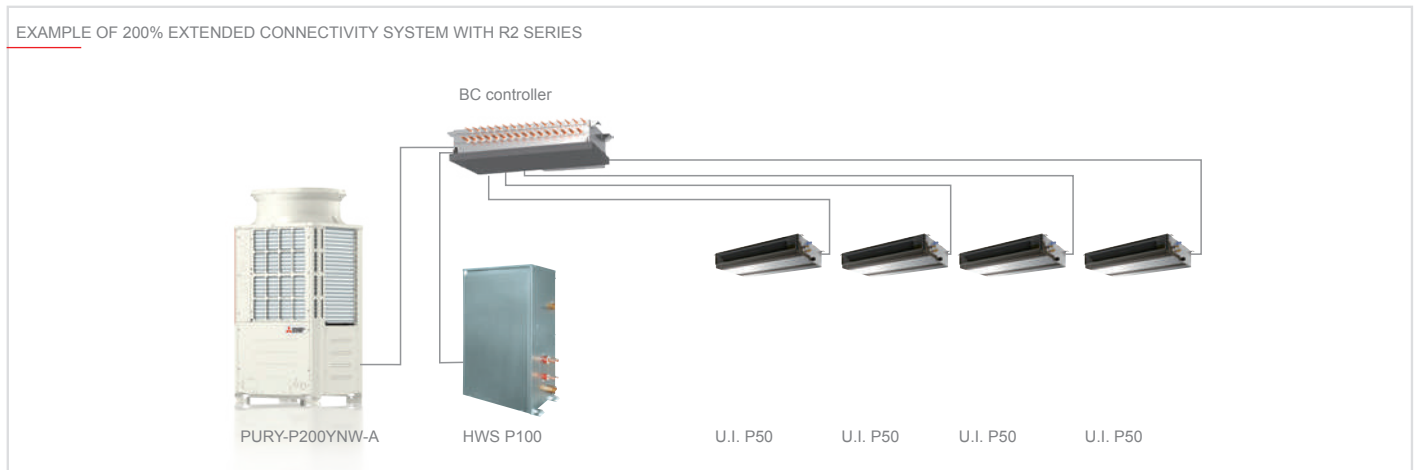

The right power for the right application

The 200% extended connectivity system conceived by Mitsubishi Electric is applicable only for mixed configurations with simultaneous production functions: domestic hot water production with HWS modules (in this case, only with R2 heat recovery simultaneous cooling and heating systems). This system requires that a precise operating limit is defined that will ensure that the outdoor unit power drawn is appropriate for the ambient loads effectively to be satisfied in all operating conditions and at all times. As a consequence, it is always important to evaluate maximum simultaneous power demand in the different operating modes possible.

Operation with simultaneous cooling and heating heat recovery systems (R2 (PURY))

Application	ATW Hydronic Module	ATW Hydronic Module	Indoor unit
	DWH Production	Primary Heating	Air Cooling and Heating
Winter	On (365days/year)	On	Off
Autumn/Spring	On (365days/year)	Off	On
Summer	On (365days/year)	Off	On



Extended settable temperature range in cooling mode, with minimum temperature of 14°C*

Where the ability to cool to temperatures lower than the standard lowest comfort value of 19°C (typically for sports centres, laboratories etc.) is necessary, the settable temperature range in cooling mode may be extended to offer a lowest temperature of 14°C.

The indoor unit fan is run at a higher speed in this configuration (except with the SMALL Y model outdoor unit of the PUMY series).

*Contact your local distributor for compatible indoor units with this function.



Rotation function

Y Series (Ecostandard Line, Y Line and Y High Efficiency Line) and R2 Series (Y Line and Y High Efficiency Line) combined modules use an automatic “Rotation Function” routine which optimises the usage of indoor and outdoor units to extend the lifespan of all system components.



Emergency backup function

Y Series (Ecostandard Line, Y Line and Y High Efficiency Line) and R2 Series (R2 Line and R2 High Efficiency Line) combined modules offer unparalleled reliability with the new emergency backup function, which is easily activated from the remote control of any indoor unit in the event of a system malfunction.

The backup function allows the system to continue operating in heating and cooling mode for an average period of 4 hours.



Energy efficiency control

Evaporating temperature control (during cooling)

In a traditional system, the evaporation temperature is kept constant regardless of the system load conditions. In low load conditions (when thermal loads to be dealt with are limited) increasing the evaporation temperature of the system decreases the compressor's workload and consequently limits the electrical absorption of the outdoor unit without affecting the environmental comfort level.

EVAPORATING TEMPERATURE CONTROL (DURING COOLING) NORMAL MODE

The evaporating temperature is kept constant regardless of the load. Even at low loads, the normal evaporating temperature does not change, which leads to energy losses during partial load operation.

SMART EVAPORATING TEMPERATURE CONTROL MODE

The evaporating temperature is increased and the compressor input is decreased according to the load, resulting in increased operating efficiency. There are two patterns to control the evaporating temperature as follows.

- 1) The evaporating temperature is controlled to be constant, regardless of the ΔT . The evaporating temperature is set to a value that is higher than the normal evaporating temperature.
- 2) The evaporating temperature is controlled by shifting it according to the ΔT . The user can select from 4 control patterns.

* The availability of 1 and 2 varies depending on the model. Refer to the function table.
* Changing the evaporating temperature reduces latent heat capacity. Select an appropriate pattern according to the installation conditions.

SUITABLE SITUATIONS

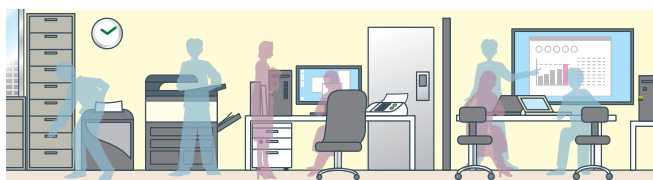

- Spaces with constant high temperatures from heat sources such as OA equipment
- When the load is low during periods when air conditioners are used for cooling (such as during the morning).

The new outdoor units are equipped with an evaporation temperature selection function, which automatically takes the system load conditions into account.

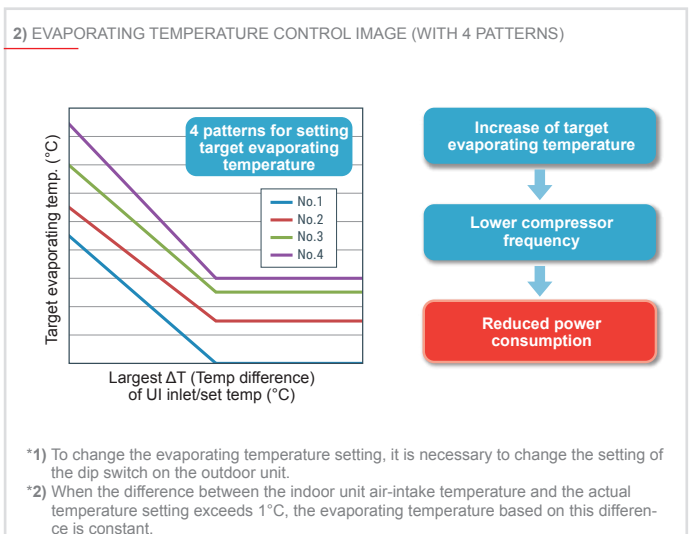
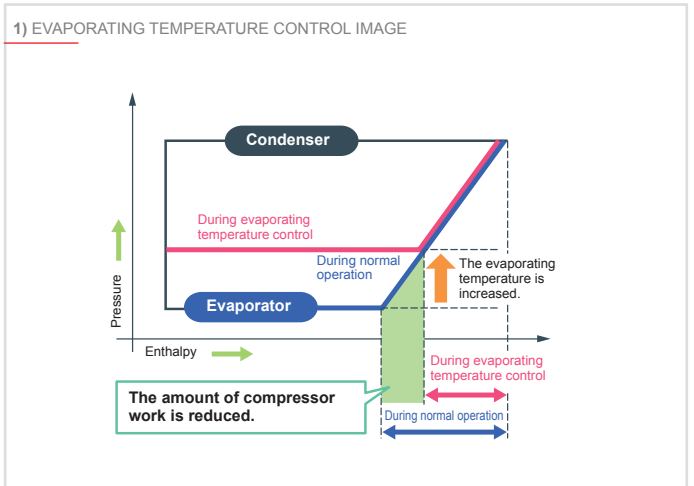

High sensible heat operation

The evaporating temperature is controlled according to room temperature and humidity, and refrigerant pressure.

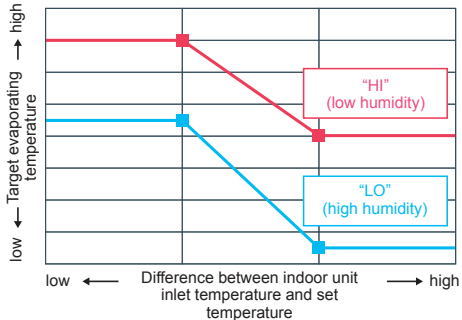

With high sensible heat operation mode activated, air conditioners consume less energy, thereby realizing cost savings. If a locally-procured humidity sensor is installed, the evaporating temperature of the outdoor unit can be controlled optimally as shown below according to the difference between the indoor unit inlet temperature and set temperature. A wide range of temperature settings are available, from a low evaporating temperature close to the temperature for normal operation to a high evaporating temperature to realize energy savings.

LOCALLY-PROCURED HUMIDITY SENSOR INSTALLATION IMAGE

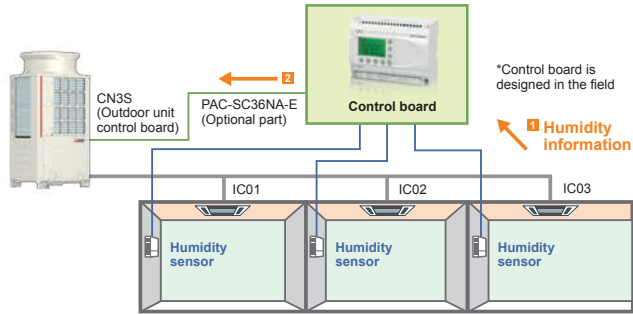

- 1 Humidity information is sent to the control board.
- 2 The control board judges the humidity information, and sends a HIGH/LOW signal to the outdoor unit through CN3S. The outdoor unit shifts the evaporating temperature depending on the information from the control board.

TEMPERATURE AND HUMIDITY CONDITIONS

	Room state	Condition of outdoor unit	Zone	Evaporating temperature control
<p>Comfortable temperature and humidity</p> <p>High sensible heat operation</p>	<p>Comfortable</p>	<p>Comfortable and energy-saving operation even at low compressor rotating speed</p>	<p>Humidity</p> <p>Temperature</p>	<p>Temperature of refrigerant in indoor unit kept high</p>
<p>High humidity</p>	<p>A little humid</p>	<p>Compressor rotating at medium speed to reduce humidity</p>	<p>Humidity</p> <p>Temperature</p>	<p>Temperature of refrigerant in indoor unit slightly reduced</p>
<p>High temperature and humidity</p>	<p>Uncomfortable</p>	<p>Compressor rotating at high speed to reduce temperature and humidity</p>	<p>Humidity</p> <p>Temperature</p>	<p>Temperature of refrigerant in indoor unit greatly reduced</p>



Dual Set Point

Normally, the desired room temperature is set to the same value for cooling and heating. However, the dual set point function makes it possible to set different temperatures for cooling and heating. When operation switches from cooling to heating or vice versa, the preset temperature changes accordingly.

Setting dual set points for the Auto mode on R2 and WR2 helps improve energy efficiency, compared to setting a single set point.

When the operation mode is set to the Auto (dual set point) mode, two preset temperatures (one each for cooling and heating) can be set. Depending on the room temperature, the indoor unit will automatically operate in either the Cool or Heat mode and keep the room temperature within the preset range. The outdoor unit does not operate in the dead band defined by two temperature points where the thermostat is off. This cuts down on unnecessary operation of the air conditioning system.

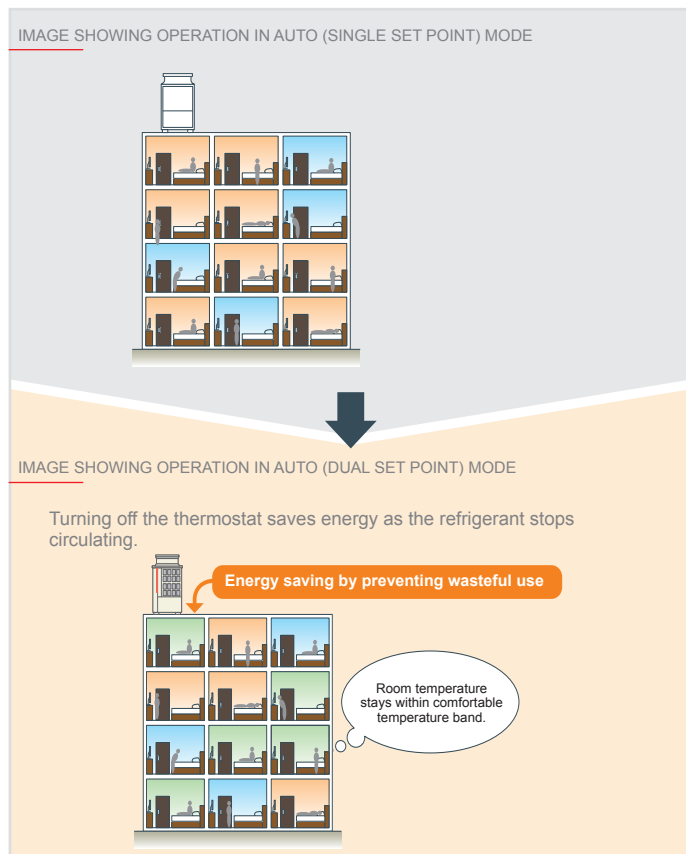
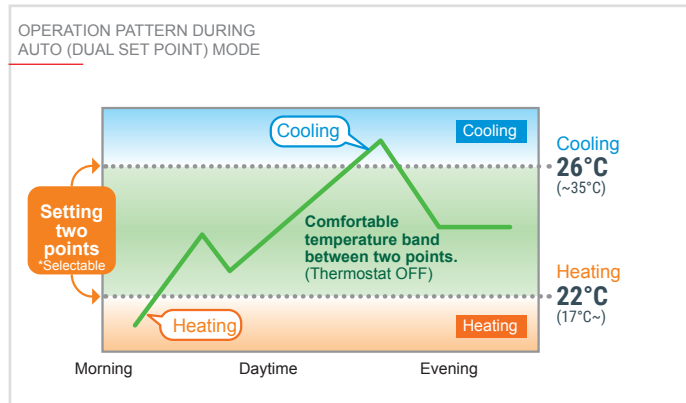

Heating operation Cooling operation Thermo OFF



Smooth auto-shift startup mode

Smooth auto-shift startup mode, a new operation mode on the outdoor unit, can now be selected in addition to the conventional COP Priority and Capacity Priority modes. In order to heat the room faster, Capacity Priority mode runs for 30 minutes when heating operation starts. The unit then switches to COP Priority mode to increase energy-saving efficiency. This enables both improved comfort and energy savings.

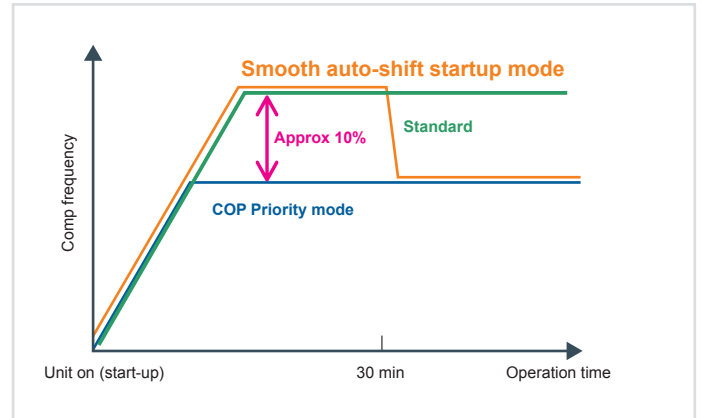

Compressor: new induction heating technology

The Y Line and R2 Line outdoor units employ a pre-heating system for the scroll compressor based on induction technology. This solution is used to warm the compressor housing to minimise energy absorption in stand-by state. Yet another solution contributing to reducing energy consumption.



Installation and maintenance

R410A R407C R22

Multi-refrigerant

The indoor units of VRF CITY MULTI systems are the first and only products on the market with multi-refrigerant capability. These units can operate with R22, R407C and R410A systems with no loss in performance, irrespective of the different pipe sizes. This allows unparalleled freedom for installation, as well as offering total reverse compatibility in the event of replacing indoor units with an R22 or R407C VRF CITY MULTI system.

80Pa ↑ Selectable external static pressure of the outdoor unit

The static pressure specification of the outdoor unit can be selected (0, 30, 60, or 80 Pa). This facilitates installation of the unit on each floor of a high-rise building or on balconies. The static pressure that can be set varies depending on the model.

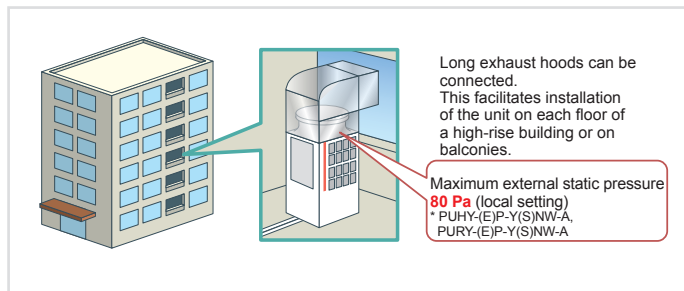

Intelligent Terminal Boards

Intelligent indoor unit terminal boards are a unique feature of Mitsubishi Electric VRF systems. These intelligent terminal boards make it possible to use the air conditioning system and the M-NET communication network, via the indoor units, as a vehicle for collecting, transferring and monitoring field signals from generic appliances such as lighting, power, access management, intelligent alarm systems etc. Using the intelligent terminal boards of the indoor units together with the existing infrastructure drastically reduces the number of cables needed to collect these field signals and the amount of labour required to route the cables to the centralized units. Typically, each indoor unit supports the following signals and functions:

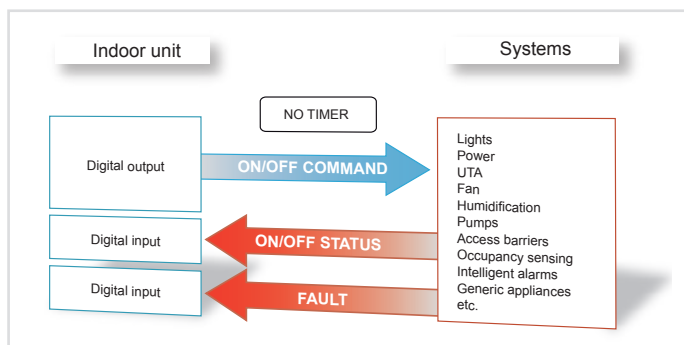

90m ↑ Usable in an application with a large vertical separation of up to 90 meters

A height difference of up to 90 m from the outdoor unit to the indoor unit can be supported with no extra-cost options. This increases design flexibility and facilitates installation of these units even in high-rise buildings.

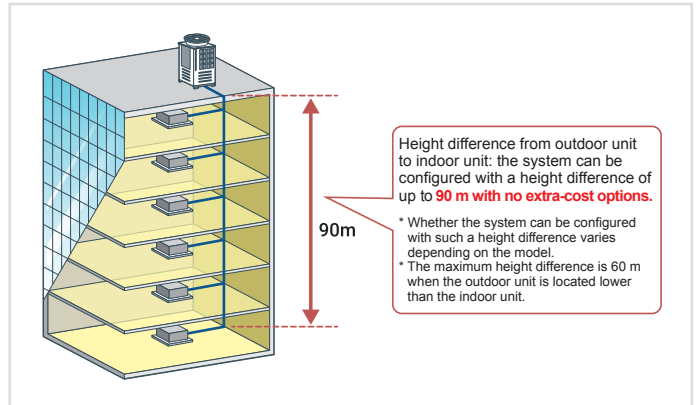

Self-diagnosis of VRF CITY MULTI system

For even simpler maintenance, CITY MULTI systems have a self-diagnostic function which is capable of communicating malfunctions on different levels using fault codes. With the special Maintenance Tool software developed by Mitsubishi Electric, the user can connect to any point in the transmission line to acquire all technical operating information interactively.

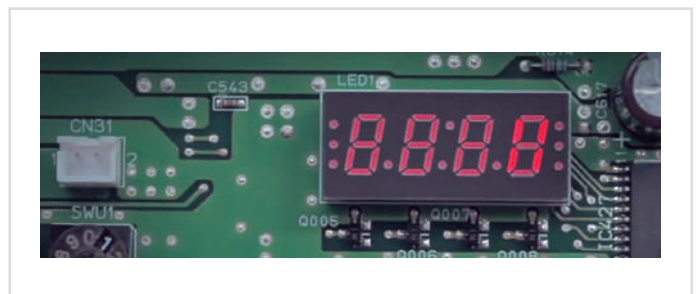



USB ↓ Downloading operating data via USB

Operation data was retrieved from conventional models using the maintenance tool. On the new model, the data can be retrieved quickly via USB*1. It is unnecessary to carry the personal computer in which the maintenance tool has been installed, reducing field operation time and improving convenience. Software can be rewritten via USB, while data for up to 4 days and the 5 minutes after an error has occurred can be stored in the the USB memory device*2.

*1 In the case of OC-IC maximum configuration
*2 USB memory devices conforming to USB2.0 can be used.

Remote monitoring and control systems

			
Group/Individual simplified management*	•	•	•
Available for Smartphone and Tablet	•	•	•
Dedicated App		•	•
User restrictions	•	•	•
Outside the building (Cloud)		•	•
Internet connection needed		•	•
WEB Server centralized control needed	•		•
Advanced energy monitoring			•
Monthly/Custom charts and reports			•
Multi-site management		•	•
Energy consumption apportioning			•

* For compatible product lines please refer to catalogues or contact headoffice



3D Tablet Controller

3D Tablet Controller is the new solution by Mitsubishi Electric allowing portable system management from Smartphone and Tablet **inside the building**. User configuration, with restrictions and privileges, makes it the ideal solution in those application serving different environments, such as offices or apartments. Thanks to its simple and intuitive interface the user is able to control and monitor **air conditioning** and **hot water production** units on **mobile device**, just as easily as he would on a traditional remote control. This is possible thanks to WEB Server 3D centralized control installed on site, connected to the building Wi-Fi router.

MELCloud



- Cloud remote **monitoring and control** system.
- Born for residential applications, it's now being expanded to VRF CITY MULTI.
- **Complete and intuitive** solution with all main control and monitoring functions.
- Does not require WEB Server 3D centralized control (AE-200, EW-50).

RMI



- Cloud remote monitoring and control system **for professional use**.
- Allows all main remote control and monitoring functions.
- **Advanced energy monitoring** features are available, such as hourly consumption view, custom charts and data collection and display.
- Geo-localized **multi-site** management.
- **Multi-user** management for centralized systems.
- Energy **consumption apportioning**.







Mitsubishi Electric for sustainability

Thanks to our network of qualified professionals, we can contribute to obtain BREEAM and LEED certifications during the design stage.



Our sustainable solutions will help you improve your BREEAM and LEED rating. We at Mitsubishi Electric have carried out BREEAM - and LEED - certified projects across Europe.

Environmental sustainability

CITY MULTI

BREEAM® Launched in the 1990s, BREEAM is one of the best-known tools to assess and certify the sustainability performance of a building.

BREEAM is based on a rating that is clear and transparent for both the client and the professionals operating in the construction industry. All this has a positive impact on the activities carried out from the design stage to when the building is used.

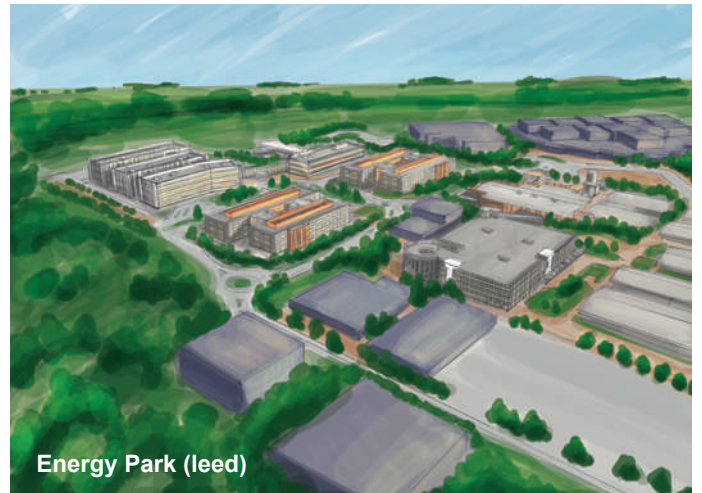

The LEED certification plays a primary role in energy and environmental design. It ensures the use of efficient and sustainable resources, as well as environmentally friendly management of the building.

The assessment criteria include sustainability of the site, energy, materials and resources used, quality of the air, internal environment, design and innovation.

There are four levels of certification: Basic, Silver, Gold, and Platinum.



All registered trademarks, brand names, and logos used or mentioned herein are the exclusive property of their respective owners and are used only for identification and description purposes.



Ecodesign - The ErP Directive

CITY MULTI

The European ecodesign directive on energy-related products (ErP) has become even more stringent to reduce greenhouse gas emissions resulting from the construction and real estate industries, overall energy consumption, and accelerate the transformation of this market with energy-efficient products.

An air conditioning system will change the performance with the changing of the seasons. That's why it's important to calculate its seasonal energy efficiency ratio (SEER) and the seasonal coefficient of performance (SCOP).

The ecodesign directive establishes the minimum efficiency requirements and a new method for measuring performance. The directive was implemented in the EU through the EN14825 standard, which establishes the seasonal performance factors of a climate control system.



Visit the website

erp.mitsubishielectric.eu/erp

Scan the QR code
to visit the website



BIM - Building information modelling

CITY MULTI

BIM is a collaborative way of working that allows the design team to share a virtual information model of a building and analyse its life cycle from design to demolition, highlighting any criticality of the technologies used.

This approach helps increase productivity and sustainability while improving risk management and reducing waste and costs.

BIM is not a tool. It's a method for working and sharing information that requires teamwork and collaboration, from when a building is first designed and commissioned to when it's used.

BIM can include any information about the building or parts of it. Usually, the information collected is about the geographic location, geometry, properties of the materials and technical elements, execution phases, and maintenance operations.

We at Mitsubishi Electric share our BIM files through the MEP content platform.

Click this link to access our BIM library
www.mepcontent.com/en/bim-files/



**Are you a designer of HVAC systems?
 Then MMESD (Mitsubishi Electric System Designer) for Revit and AutoCAD is the add-on you need.**

Download it now.
 You can use CAD files and Mitsubishi Electric Revit families to design in BIM successfully. If you have any doubts, our video tutorials can help solve them.

Click the link
<https://www.mepcontent.com/en/apps/detail/11/>
 to download the app and watch the demo



Click the link
<https://youtu.be/Pr5GiYmKfD8>
 to watch the video tutorials

MEPcontent







VRF Systems

Outdoor units

Air condensed

SMALL Y COMPACT LINE

PUMY-SM Y(V)KM (-BS)		42
PUMY-SP Y(V)KM (-BS)		48

SMALL Y LINE

PUMY-P Y(V)KM (-BS)		54
---------------------	---	----

SMALL Y (HIGH CAPACITY) LINE

PUMY P200 YKM (-BS) / PUMY P250/300 YBM (BS)		58
--	---	----

Y ZUBADAN LINE

PUHY-HP Y(S)NW-A		64
------------------	---	----

Y NEXT STAGE LINE

PUHY-(E)P Y(S)NW-A2(-BS)		70
--------------------------	---	----

R2 NEXT STAGE LINE

PURY-(E)P Y(S)NW-A2(-BS)		80
--------------------------	---	----



Water condensed

WY WR2 LINE





PQH(R)Y-P Y(S)LM-A1 88

BC controllers for R2/WR2 lines







CMB-M V-J1/V-JA1/V-KB1, CMB-P V-KA1 98

Refrigerant piping length

102

		Line					
		Model	PUMY-SM-Y(V)KM	PUMY-SP-Y(V)KM	PUMY-P-Y(V)KM	PUMY P-YKM/YBM	PUHY-P-Y(S)NW-A2
Technology	Inverter-driven compressor technology	•	•	•	•	•	•
	IH warmer						•
	Flat tube Heat exchanger						
Function	Operation mode	COP priority mode					•
		Low noise mode	• Super silent mode	• Super silent mode	•	•	50, 60, 70, 85, 100%
		Auto-shift mode					•
		Dual set point	•	•	•	•	•
	Energy efficiency control	Evaporating temperature control (Fixed temperature control irrespective of the ΔT)					+6°C, +9°C, +14°C
		Evaporating temperature control (Automatic control shifting according to the ΔT)					4 patterns
		High sensible heat operation (during cooling)					•
		Demand control	4 steps	4 steps	4 steps	4 steps	12 steps
	Defrosting	Continuous heating operation					•
		Pre-heat defrost					•
	External static pressure	Selectable external static pressure of outdoor unit	30 Pa	30 Pa	30 Pa	30 Pa YBM only	0, 30, 60, 80 Pa
	High ambient temperature	Operation at high outside temperatures	52°C	52°C	52°C	52°C	52°C
	Piping length flexibility	Usable in an application with a large vertical separation of up to 90 meters					•
	Maintenance	Rotation control					•
		Emergency operation mode					•
		Pump down function					• Automatic
		M-Net Power	•	•	•	•	•
		USB Data download					•

* Power supplied to the heater only for 22HP and 24HP (P550 and P600) single modules

						
	PUHY-EP-Y(S)NW-A2	PUHY-HP Y(S)NW-A	PQHY-P-Y(S)LM-A1	PURY-P-Y(S)NW-A2	PURY-EP-Y(S)NW-A2	PQRY-P-Y(S)LM-A1
	•	•	•	•	•	•
	•	•	• *	•	•	• *
	•	•			•	
	•	•		•	•	
	50, 60, 70, 85, 100%	50, 60, 70, 85, 100%	50, 100%	50, 60, 70, 85, 100%	50, 60, 70, 85, 100%	50, 100%
	•			•	•	
	•	•	•	•	•	•
	+6°C, +9°, +14°C	+6°C, +9°, +14°C	+6°C, +9°, +14°C	+6°C, +9°, +14°C	+6°C, +9°, +14°C	+6°C, +9°, +14°C
	4 patterns	4 patterns	4 patterns	4 patterns	4 patterns	4 patterns
	•	•	•	•	•	•
	12 steps	12 steps	8 steps	8 steps	8 steps	8 steps
	•			•	•	
	•			•	•	
	0, 30, 60, 80 Pa	0, 30, 60, 80 Pa		0, 30, 60, 80 Pa	0, 30, 60, 80 Pa	
	52°C	52°C	-	52°C	52°C	-
	•	•		•	•	
	•	•	•	•	•	•
	•	•	•	•	•	•
	•	•	•	•	•	•
	Automatic	•	•	Automatic	Automatic	•
	•	•	•	•	•	•
	•			•	•	

SMALL Y COMPACT LINE

NEW

OUTDOOR UNITS - PUMY-SM Y(V)KM (-BS)



COMPACT SIZE AND
LOW WEIGHT

HIGH ENERGY
EFFICIENCY
(EER/COP UNDER
STANDARD RATING
CONDITIONS)

SUPER SILENT
MODE



AN EXTERNAL STATIC
PRESSURE OF 30PA

REAR PIPING
IS AVAILABLE

A WIDE VARIETY
OF INDOOR UNITS
FOR BRANCH BOX
CONNECTION

SMALL Y COMPACT Line with safety measure included R32

- Available in three sizes from 12,5 up to 17,5 kW
- Single-phase and three-phase versions
- Solution plug & play with intergrated safety measures
- High seasonal performance SEER/SCOP

Compact and lightweight

- Compact design fits into restricted outdoor unit space of condominiums and offices.
- Lightweight design facilitates easy installation and transportation.

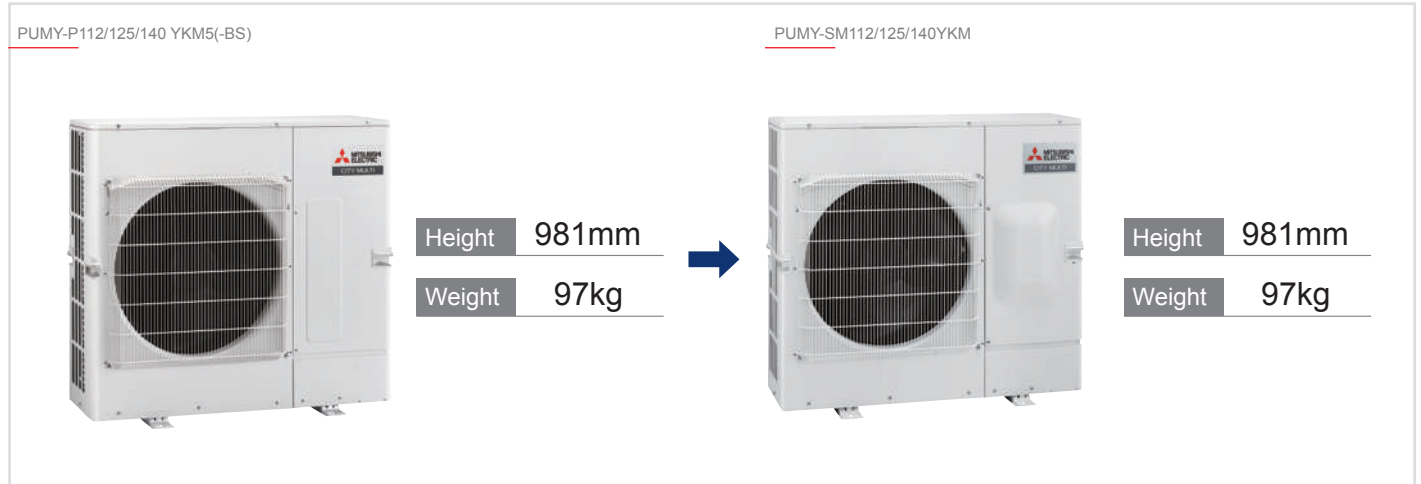

Energy efficiency

Even with its compact size and lightweight, it has a high EER and COP. Costs are reduced with the energy saving abilities.

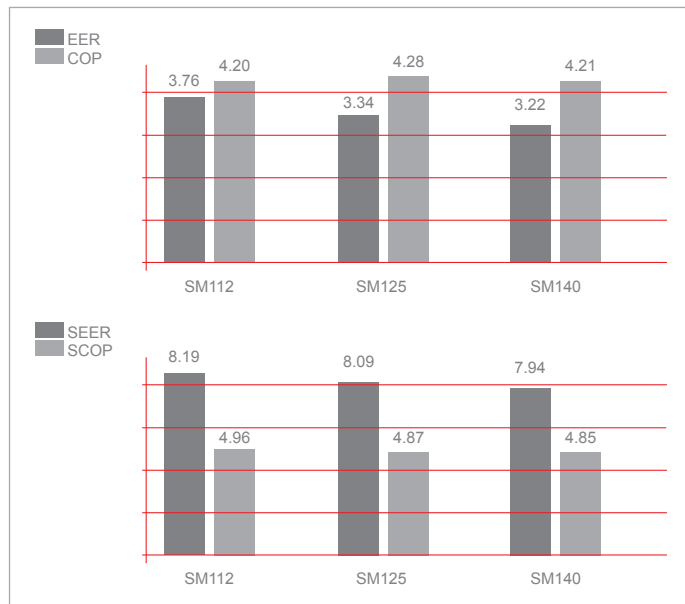

*Temperature conditions
 EER : Indoor 27°C DB / Outdoor 35°C DB
 COP : Indoor 20°C DB / Outdoor 7°C DB
 SCOP/SEER: Based on ErP Lot 21/6 calculation method to EN14825.

Rear piping is available

Freedom with layout due to its piping pullout locations in four directions.

The outdoor unit allows piping from any four directions; front, rear, bottom, or right. This enables easier horizontal connection for collective layout. The outdoor unit with an expanded piping layout flexibility greatly improves piping workability.

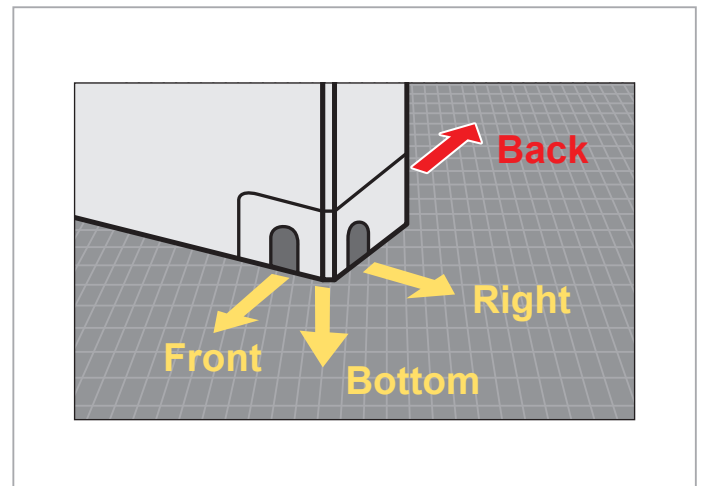

Compact, and easy to hide from view

Conventional 2-fan type outdoor units may spoil the view. Thanks to its compact size, the new 1-fan type outdoor units can be installed in locations that would have been inappropriate.

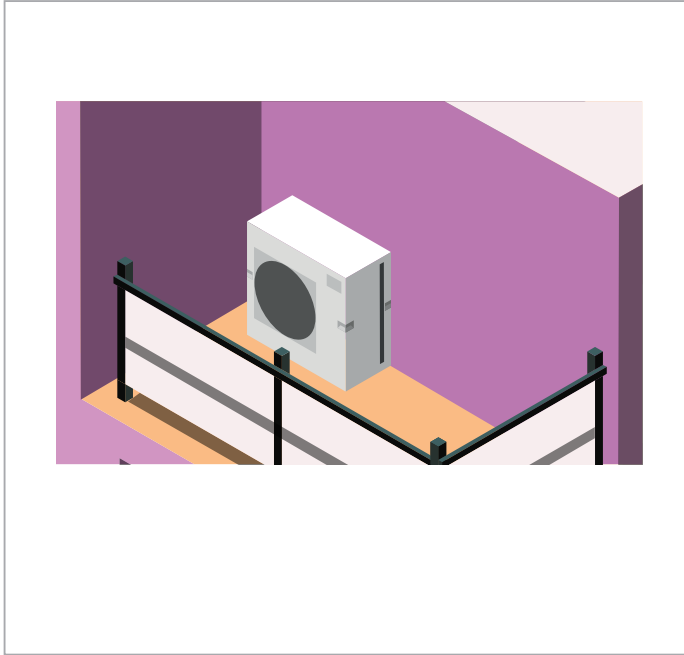

Easy installation and transport

The reduced weight and height allow for better transportation performance. Carrying and installing become easier



External static pressure mode (30 Pa)

The installation location is flexible, thanks to its 30Pa external static pressure mode. You can install it in locations that you could not before. The external pressure mode allows outdoor unit to be installed on balconies in high-rise building or spaces near louvers.

*Noise level will increase when using this function.

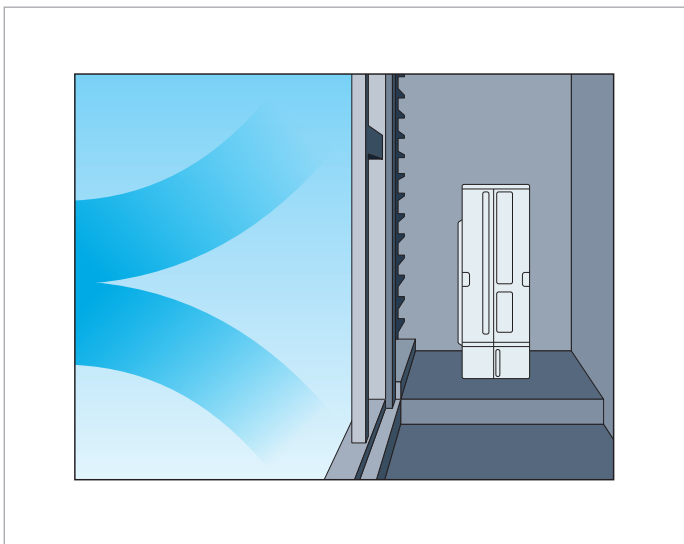

Super silent mode*

- Noise level can be reduced up to 10dB(A).
- This allows you to operate the unit even in the night in a residential zone.

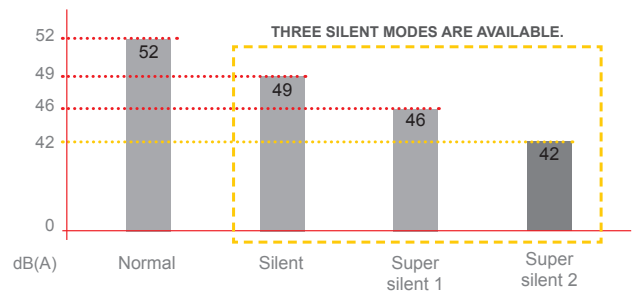

PUMY-SM112V(Y)KM

Noise levels can be reduced up to 10 dB(A).





Summary of System component

S&A kit • Remote controller

	Appearance	System	Features
S&A kit	<p>PAC-SK60SA-E</p> 	Branch box	<ul style="list-style-type: none"> • Connected from branch box • Sensor and alarm in the device • Have 3 types of LED (operation, detection, error) • Detection of refrigerant leakage, a kit alerts and LED flashes in red • Alarm can be stopped only by a kit in a room that refrigerant leakage occurred
Remote controller	<p>PAR-41MAAB</p> 	VRF	<ul style="list-style-type: none"> • Connected from indoor unit • Alarm in the device • Have a display • In case of refrigerant leakage, R/C alerts and error code and address of indoor unit is shown • Alarm can be stopped by a R/C in a room that refrigerant leakage occurred and a supervisor room

*Can be used as a Wired remote control in a Branch box system. However, in this case, a separate S/A kit connection is required.

Branch box

			
Model name		PAC-MMK40BC(B)	PAC-MMK60BC
Number of ports		4 ports	6 ports
Refrigerant		R32	R32
Input(kW)		0.003	0.006
Running current(A)		0.15	0.30
Size(mm)	H W D	170 450 372	170 665 420
Installation	Ceiling-suspended Floor-standing Vertical No need drainpan	✓ ✓ ✓ ✓	✓ ✓ ✓ ✓
Connection	Flare connection Blazing	✓ ✓	✓ -

Branch Piping(Ø) liquid/gas [mm]	1st	6.35/9.52
	2nd	6.35/9.52
	3rd	6.35/12.7
	4th	6.35/9.52
	5th	6.35/9.52
	6th	9.52/15.88
Piping/Wiring	<ul style="list-style-type: none"> • Piping connection from both side and wiring connection from one side. • If necessary, you need to flip over only electrical box to connect from the other side. 	
Instability	<ul style="list-style-type: none"> • Possible to make piping connection from both side. • Flipping over only electrical box is not difficult for installer. • Ø9.52/Ø15.88 can be connected to a large indoor unit placed in a living room or other large room. 	

Comply with IEC60335 2-40(Ed.6)









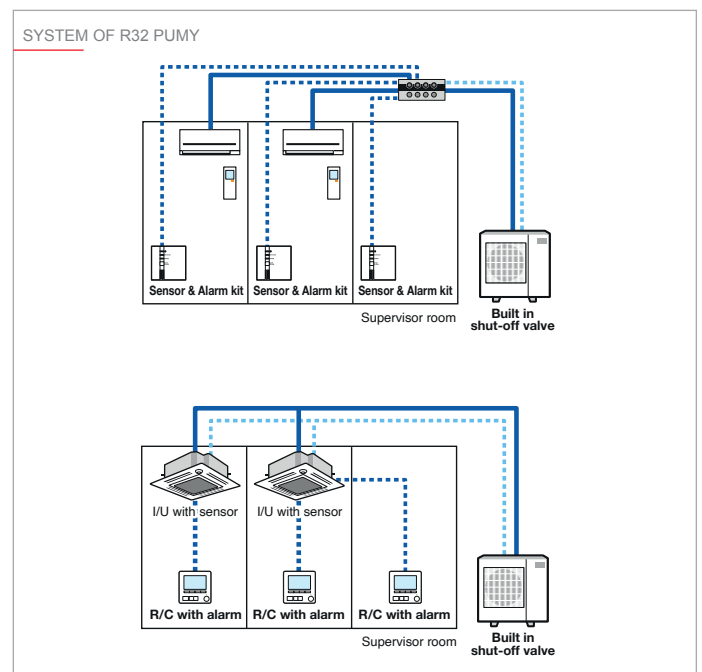

The product standard IEC60335-2-40 (Ed.6) specifies the following:

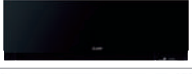



- The minimum room surface that needs to be respected, in function of the total refrigerant quantity of the system.
- The measures that can be implemented to relax limitations on minimum room surface in relation to the system's total refrigerant charge.

Possible measures towards flammability

- **Manufacturers have the choice to implement zero, one or two measures.**
- 3 types of measures are allowed :
 - Ventilation(natural or mechanical)
 - Shut-off valves
 - Alarm(local and supervisor)



INDOOR UNIT FOR BRANCH BOX CONNECTION			
Type	Series	Model name	Model
Wall Mounted	L-series	MSZ-LN	
	RW-series	MSZ-RW	
	E-series	MSZ-EF	
	BT-series	MSZ-BT	
	A-series	MSZ-AP MSZ-AY	
4-way Cassette		PLA-M	
		SLZ-M	
1-way Cassette		MLZ-KP MLZ-KY	
Ceiling Suspended		PCA-M	
Ceiling Concealed		SEZ-M	
		PEAD-M	

INDOOR UNIT FOR FREE PLAN CONNECTION (CITY MULTI SERIES)*1		
Type	Model name	Model
4-way Cassette	PLFY-M-VEM6*2 PLFY-MS-VEM-E	
	PLFY-MS-VFM-E*3	
Ceiling Concealed	PEFY-M-VMA(L)-A1*2 PEFY-MS-VMA(L)-A	
Ceiling Suspended	PCFY-MS-VKM-E*3	
Wall Mounted	PKFY-MS-VKM-E*3 PKFY-MS-VLM-E*3	

*1 Connectable indoor unit varies depending on capacity.
 *2 M models (R410A/R32 common) can be used only for applications that do not require on-site fire prevention safety measures.
 *3 Please contact the installer for PKFY/PCFY/PLFY-VFM date of sale.

PUMY-SM Series Free plan connection for PUMY-SM112/125/140

Series	Model Name	Capacity													
		Sensor	10	15	20	25	32	40	50	63	71	80	100	125	140
City Multi Series	PLFY-M-VEM6-E				●	●	●	●	●	●	●	●	●	●	●
	PEFY-M-VMA-A1				●	●	●	●	●	●	●	●	●	●	●
	PLFY-MS-VEM-E	✓			●	●	●	●	●	●	●	●	●	●	●
	PLFY-MS-VFM-E*	✓		●	●	●	●	●	●	●	●	●	●	●	●
	PCFY-MS-VKM-E*	✓						●	●	●	●	●	●	●	●
	PKFY-MS-VLM-E*	✓	●	●	●	●	●	●	●	●	●	●	●	●	●
	PKFY-MS-VKM-E*	✓						●	●	●	●	●	●	●	●
	PEFY-MS-VMA-A	✓				●	●	●	●	●	●	●	●	●	●

* Please contact the installer for PKFY/PCFY/PLFY-VFM date of sale.

PUMY-SM Series Branch Box Connection Compatibility Table for PUMY-SM112/125/140

Series	Type	Model Name	Capacity											
			15	18	20	22	25	35	42	50	60	71	100	
M Series	Wall-mounted	MSZ-RW-VG									●			
		MSZ-LN-VG2					●	●		●				
		MSZ-AP-VG(K)	●		●		●	●	●	●				
		MSZ-AY-VG(K)(P)					●	●	●	●				
		MSZ-EF-VG(K)		●		●	●	●	●	●				
		MSZ-BT-VG(K)					●	●						
S Series	1-way Cassette	MLZ-KY-VG			●						●			
		MLZ-KP-VF					●	●		●				
S Series	Ceiling-Concealed	SEZ-M-DA(L)2						●	●		●	●	●	
	4-way Cassette	SLZ-M-FA2	●					●	●		●			
P Series	Ceiling-Suspended	PCA-M-KA2							●		●	●	●	
	4-way Cassette	PLA-M-EA2							●		●	●	●	
P Series	Ceiling-Concealed	PEAD-M-JA(L)2								●	●	●	●	

Technical specifications

MODEL			PUMY-SM112VKM	PUMY-SM125VKM	PUMY-SM140VKM	PUMY-SM112YKM	PUMY-SM125YKM	PUMY-SM140YKM	
HP			4.5	5.0	6.0	4.5	5.0	6.0	
Power			1-phase 220-230-240V 50Hz, 220V 60Hz			3-phase 380-400-415V 50Hz, 380V 60Hz			
Cooling Capacity		kW	12.5	14.0	15.5	12.5	14.0	15.5	
(Nominal)	Power input	kW	3.32	4.19	4.81	3.32	4.19	4.81	
	Current input	A	15.40 - 14.73 - 14.12 / 15.40	19.43 - 18.59 - 17.81 / 19.43	22.45 - 21.47 - 20.58 / 22.45	5.31 - 5.04 - 4.86 / 5.31	6.70 - 6.37 - 6.14 / 6.70	7.74 - 7.35 - 7.09 / 7.74	
	SEER	kW/kW	8.19	8.09	7.94	8.19	8.09	7.94	
Temp. range of cooling	Indoor temp.	W.B.*1	15.0 to 24.0 °C						
	Outdoor temp.	D.B.*2*3	-5.0 to 52.0 °C						
Heating Capacity		kW	14.0	16.0	17.5	14.0	16.0	17.5	
(Nominal)	Power input	kW	3.33	3.73	4.15	3.33	3.73	4.15	
	Current input	A	15.45 - 14.77 - 14.16 / 15.45	17.30 - 16.55 - 15.86 / 17.30	19.25 - 18.41 - 17.64 / 19.25	5.33 - 5.06 - 4.88 / 5.33	5.97 - 5.67 - 5.46 / 5.97	6.64 - 6.31 - 6.08 / 6.64	
	SCOP	kW/kW	4.96	4.87	4.85	4.96	4.87	4.85	
Temp. range of heating	Indoor temp.	W.B.	15.0 to 27.0 °C						
	Outdoor temp.	D.B.	-20.0 to 15.0 °C						
Indoor unit connectable	Total capacity		50 to 130% of outdoor unit capacity						
	Model / Quantity	City Multi	10 - 140 / 12						
		Branch Box	15 - 100 / 8						
		Mixed System	Branch box 1unit	10 - 140 / 3 or 5 *4					
			Branch box 2unit	15 - 100 / 4 or 6 *5					
Branch Box		10 - 140 / 2 or 3 *6							
Sound Pressure Level(Cooling/Heating)	dB <A>		52 / 54	53 / 56	54 / 56	52 / 54	53 / 56	54 / 56	
Sound Power Level	Cooling/Heating	dB <A>	74	76	76	74	76	76	
Refrigerant piping diameter	Liquid piping	mm	9.52 Flare						
	Gas piping	mm	15.88 Flare						
Fan	Type × Quantity		Propeller Fan × 1						
	Air flow rate	m3/min	77	83	83	77	83	83	
		L/s	1,283	1,383	1,383	1,283	1,383	1,383	
		cfm	2,719	2,931	2,931	2,719	2,931	2,931	
	Motor output	kW	0.20 × 1						
External static press.	Pa	0 Pa / 30 Pa *7							
Compressor	Type × Quantity		Twin rotary hermetic compressor × 1						
	Starting method		Inverter						
	Motor output	kW	2.3	2.6	3.0	2.3	2.6	3.0	
External Dimensions (HxWxD)	mm	981×1,050×330(+40)							
Net weight	kg (lbs)	95(209) *8			97(214) *9				
Pre-Charged quantity	Weight	kg	3.0						
	CO ₂ equivalent	t	2.03						
Max system quantity	Weight	kg	7.5						
	CO ₂ equivalent	t	5.06						

*1 15 to 23°C when using branch box(M/S/P series)

*2 10 to 52°C; in case of connecting PKFY-MS*VKM, PKFY-MS*VLM indoor unit and M series, S series and P series type indoor unit with branch box.

*3 -15 to 52°; when using an optional air protect guide [PAC-SH95AG-E]. However, this condition does not apply to the indoor unit listed in*1.

*4 When connected branch box is PAC-MMK60BC, connectable City Multi indoor units are 3; connected branch box is PAC-MMK40BC(B), connectable City Multi indoor units are 5.

*5 When connected branch box is PAC-MMK40BC(B), connectable indoor units via branch box are 4; connected branch box is PAC-MMK60BC, connectable indoor units via branch box are 6.

*6 When connected branch boxes are PAC-MMK40BC(B) and PAC-MMK60 BC, connectable City Multi indoor units are 2; connected branch boxes are PAC-MMK40BC(B) and PAC-MMK40BC(B), connectable City Multi indoor units are 3; connected branch boxes are PAC-MMK60BC and PAC-MMK60BC are not allowed.

*7 0 Pa as initial setting

*8 96 (212), for PUMY-SM112/125/140VKM-BS

*9 98 (216), for PUMY-SM112/125/140YKM-BS

Indoor unit connectable table

Model Name		PUMY-SM112Y(K)KM	PUMY-SM125Y(K)KM	PUMY-SM140Y(K)KM
CM Indoor Only		12	12	12
Branch box Only		8	8	8
Mix system	CM Indoor	3	3	3
Branch box 1unit	Branch box	6	6	6
PAC-MMK60BC		9	9	9
Mix system	CM Indoor	5	5	5
Branch box 1unit	Branch box	4	4	4
PAC-MMK40BC(B)		9	9	9
Mix system	CM Indoor	2	2	2
Branch box 1unit	Branch box	8	8	8
PAC-MMK60BC + PAC-MMK40BC(B)		10	10	10
Mix system	CM Indoor	3	3	3
Branch box 1unit	Branch box	8	8	8
PAC-MMK40BC(B) 2unit		11	11	11

SMALL Y COMPACT LINE

OUTDOOR UNITS - PUMY-SP Y(V)KM2 (-BS)



COMPACT SIZE AND LOW WEIGHT

MAXIMUM FLEXIBILITY OF CONNECTION THROUGH BRANCH BOX

TOP OF THE RANGE EFFICIENCY



SUPER SILENT MODE

UP TO 30 PA STATIC PRESSURE OUTDOOR FAN UNIT

FLEXIBLE PIPE CONNECTION

Compact dimensions





The SMALL Y COMPACT (PUMY-SP) delivers the power and performance of a VRF system in residential applications with a significantly smaller footprint than ever before, thanks to its new single-fan design.

<u>PUMY-P YKM3(-BS)</u>		<u>PUMY-SP Y(V)KM(-BS)</u>											
	<table border="1"><tr><td>Height</td><td>1,338mm</td></tr><tr><td>Weight</td><td>125kg</td></tr></table>	Height	1,338mm	Weight	125kg		<table border="1"><tr><td>27% down</td></tr><tr><td>Height</td><td>981mm</td></tr><tr><td>25% down</td></tr><tr><td>Weight</td><td>94kg</td></tr></table>	27% down	Height	981mm	25% down	Weight	94kg
Height	1,338mm												
Weight	125kg												
27% down													
Height	981mm												
25% down													
Weight	94kg												

Easy installation and transport

The compact chassis of the SMALL Y COMPACT (PUMY-SP) and above all its low height (under one metre) make the machine suitable for installation on balconies. The low weight makes the unit easy to transport.

THE OUTDOOR UNIT CAN BE INSTALLED ON BALCONIES

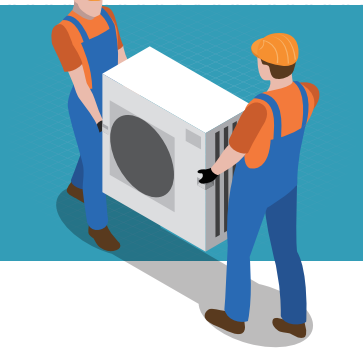
Top of the range efficiency

Despite its compact size and low weight, the new SMALL Y COMPACT (PUMY-SP) provides top of the range efficiency. This reduces operating costs.

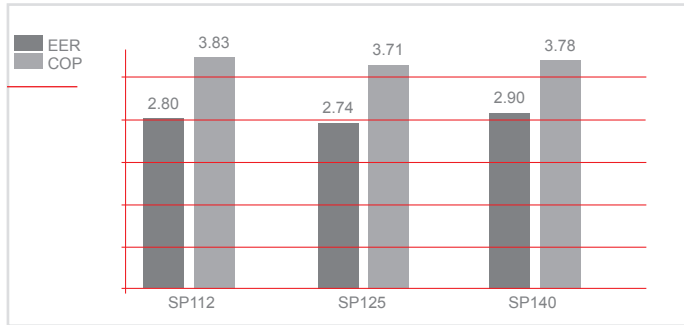

Super Silent Mode

The SMALL Y COMPACT (PUMY-SP) is the first model in the range that can operate in the new "Super Silent" mode, which reduces sound emission by -10dB(A). It is therefore possible to install the unit even in particularly sensitive acoustic environments.

*The optional PAC-SC36NA-E connector is required in order to activate "Super Silent" mode.
*System capacity is reduced if "Silent" or "Super Silent" mode is activated.

Geometric limits

The compactness of the new model SMALL Y COMPACT (PUMY-SP) does not affect the system's flexibility, so it is still possible to have extended and capillary pipe development.

GEOMETRIC LIMITS	
	PUMY-SP112/125/140 VKM(-BS)/YKM(-BS)
Total length of pipes	120 m
Total pipe length after branch box/boxes	70 (90) m
Maximum level difference between UI and UE (UE above)	50 m
Maximum height difference between UI and UE (UE below)	30 m

Flexible connection

The new SMALL Y COMPACT line is equipped with front, side, rear and lower refrigeration connections, making it easier to install.

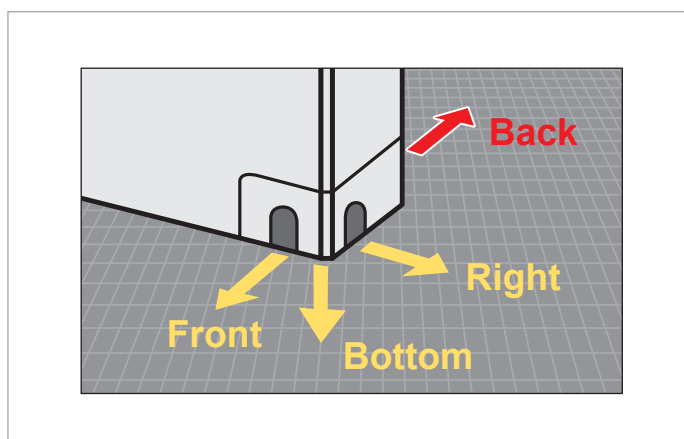

Static pressure outdoor fan unit

The 30 Pa static pressure option increases flexibility in the choice of the unit's installation point.

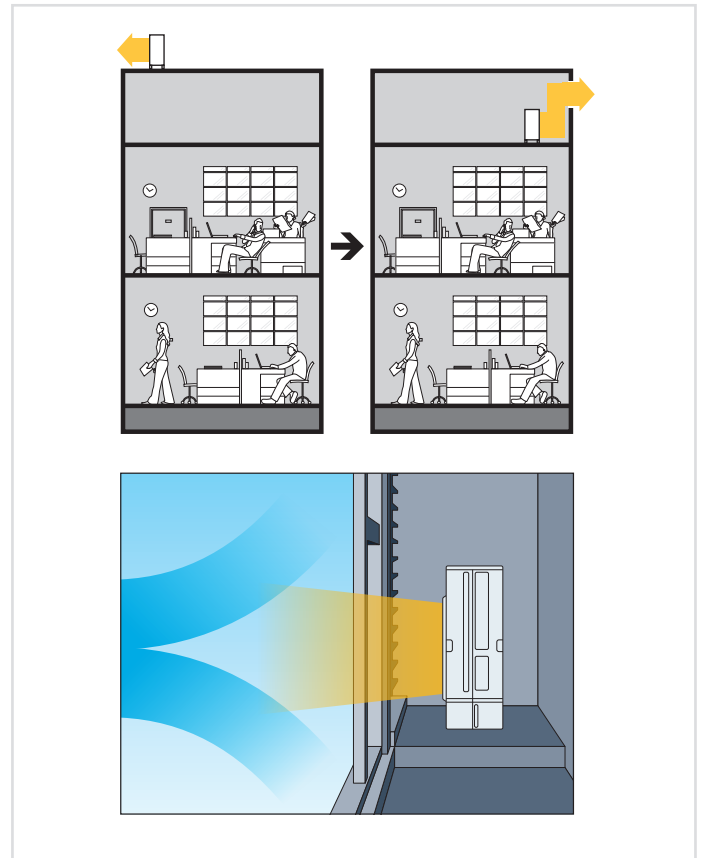

Connectivity

SMALL Y COMPACT (PUMY-SP) single-fan units can be connected to Residential and Commercial line indoor units by branch-box PAC-MK34/54. It is also possible to create mixed systems with VRF indoor units and residential and commercial units. Thanks to these features, the system has essentially unlimited flexibility, serving every need.

New Branch Box (3 and 5 connections) - Total flexibility

The new Branch Boxes are designed to give the system the highest possible flexibility of configuration. It is therefore possible to create systems with CITY MULTI VRF units, consisting exclusively of Residential/Commercial Series indoor units or mixed systems in which the two types of units coexist.



M-NET Branch Box

The new PAC-MK34/54 branch boxes are designed for direct connection to MELANS control and supervision systems. To connect a system composed of internal units of the Residential or Commercial Line to an M-Net centraliser, it is therefore not necessary to provide a dedicated interface. Instead it is sufficient to use Branch Boxes and connect them to the communication bus consisting of a simple two-wire, non-polarised cable. In addition, the new Branch Boxes do not need to be prepared for condensate drainage.

Model	1 Branch Box		2 Branch Box	
	Via Branch Box	CITY MULTI Indoor units	Via Branch box	CITY MULTI Indoor units
PUMY-SP112	Max. 5	Max. 5	Max. 7	Max. 3
			Max. 8	Max. 2
PUMY-SP125	Max. 5	Max. 5	Max. 8	Max. 3
PUMY-SP140				

Technical specifications

MODEL			PUMY-SP112VKM2 (-BS)	PUMY-SP112YKM2 (-BS)	PUMY-SP125VKM2 (-BS)	PUMY-SP125YKM2 (-BS)	PUMY-SP140VKM2 (-BS)	PUMY-SP140YKM2(-BS)
HP			4.5	4.5	5.0	5.0	6.0	6.0
Power	Phases/Voltage/Freq.	V/Hz/n ^o	1-phase 220-230-240V 50Hz, 220V 60Hz	3-phase 380-400-415V 50Hz, 380V 60Hz	1-phase 220-230-240V 50Hz, 220V 60Hz	3-phase 380-400-415V 50Hz, 380V 60Hz	1-phase 220-230-240V 50Hz, 220V 60Hz	3-phase 380-400-415V 50Hz, 380V 60Hz
Cooling	Nominal capacity*1	kW	12.5	12.5	14.0	14.0	15.5	15.5
	Power absorption	kW	4.46	4.46	5.11	5.11	5.34	5.34
	SEER		7,13	7,13	7,20	7,20	7,37	7,37
	Operating temperature range	Indoor WB	°C	15.0~24.0°C	15.0~24.0°C	15.0~24.0°C	15.0~24.0°C	15.0~24.0°C
Outdoor DB*3*4		°C	-5.0~52.0°C	-5.0~52.0°C	-5.0~52.0°C	-5.0~52.0°C	-5.0~52.0°C	-5.0~52.0°C
Heating	Nominal capacity*2	kW	14.0	14.0	16.0	16.0	16.5	16.5
	Power absorption	kW	3.66	3.66	4.31	4.31	4.36	4.36
	SCOP		5.07	5.07	4.22	4.22	4.48	4.48
	Operating temperature range	Indoor DB	°C	15.0~27.0°C	15.0~27.0°C	15.0~27.0°C	15.0~27.0°C	15.0~27.0°C
Outdoor WB		°C	-20.0~15.0°C	-20.0~15.0°C	-20.0~15.0°C	-20.0~15.0°C	-20.0~15.0°C	-20.0~15.0°C
Sound pressure*5	Heating/Cooling	dB(A)	52/54	52/54	53/56	53/56	54/56	54/56
Connectable indoor units	Model/ Quantity	CITY MULTI	50~130 % of outdoor unit capacity	50~130 % of outdoor unit capacity	50~130 % of outdoor unit capacity	50~130 % of outdoor unit capacity	50~130 % of outdoor unit capacity	50~130 % of outdoor unit capacity
		Branch Box	P10-P140, M20-M140/9	P10-P140, M20-M140/9	P10-P140, M20-M140/10	P10-P140, M20-M140/10	P10-P140, M20-M140/12	P10-P140, M20-M140/12
		Mixed System	P15~P100/8	P15~P100/8	P15~P100/8	P15~P100/8	P15~P100/8	P15~P100/8
External diameter of refrigerant connectors	Liquid/Gas	mm	9.52/15.88	9.52/15.88	9.52/15.88	9.52/15.88	9.52/15.88	9.52/15.88
	External dimensions	mm	981 x 1,050 x 330 (+40)	981 x 1,050 x 330 (+40)	981 x 1,050 x 330 (+40)	981 x 1,050 x 330 (+40)	981 x 1,050 x 330 (+40)	981 x 1,050 x 330 (+40)
	Net weight	kg	93	94	93	94	93	94
	Ref Charge R410A/CO ₂ Eq	kg	3.5 / 7.31	3.5 / 7.31	3.5 / 7.31	3.5 / 7.31	3.5 / 7.31	3.5 / 7.31

*1,*2 Nominal conditions

	Indoor	Outdoor	Pipe length	Level difference
Cooling	27°C DB/19°C WB	35°C DB	7.5m	0m
Heating	20°C DB	7°C DB/6°C WB	7.5m	0m

*3 10 to 52.; when connecting following models: PKFY-P10/15/20/25/32VLM, PFFY-P20/25/32VLE(R)M, PFFY-P20/25/32VKM, PFFY-P20/25/32VCM, and M-Series, S-Series, and P-Series type indoor unit with branch box, M-Series type indoor unit with connection kit.

*4 -15 to 52.; when using an optional air protect guide [PAC-SH95AG-E]. However, this condition does not apply to the indoor unit listed in*3.

*5 Cooling mode/Heating mode

*6 External static pressure option is available (30 Pa/3.1 mmH2O).

*7 94 (207), for PUMY-SP112/125/140VKM2-BS,

*8 95 (209), for PUMY-SP112/125/140YKM2-BS.

*Nominal condition *1,*2 are subject to ISO 15042.

*Due to continuing improvement, above specification may be subject to change without notice.

PUMY-SP Series Branch Box Connection Compatibility Table for PUMY-SP112/125/140

Series	Type	Model Name	Capacity										
			15	18	20	22	25	35	42	50	60	71	100
M Series	Wall-mounted	MSZ-LN-VG2					●	●		●			
		MSZ-RW-VF-E					●	●		●			
		MSZ-AP-VG(K)	●		●		●	●	●	●			
		MSZ-FH-VE2					●	●		●			
		MSZ-EF-VG(K)		●		●	●	●	●	●			
		MSZ-SF-VA	●		●								
		MSZ-AP-VF-E	●		●								
	Floor-Standing	MSZ-SF-VE3					●	●	●	●			
		MSZ-GF-VE2									●	●	
		MFZ-KT-VG					●	●		●			
1-way Cassette	MFZ-KJ-VE-E					●	●		●				
	MLZ-KP-VF					●	●		●				
S Series	Ceiling-Concealed	MLZ-KA-VA-E					●	●		●			
		SEZ-M-DA(L)(2)					●	●		●	●	●	
	2x2 Cassette	SEZ-KD-VA-E					●	●		●	●	●	
		SLZ-M-FA(2)	●				●	●		●			
P Series	Ceiling-Suspended	SLZ-KF-VA-E					●	●		●			
		PCA-M-KA(2)						●		●	●	●	
	4-way Cassette	PCA-RP-KAQ-E						●		●	●	●	
		PLA-M-EA(2)						●		●	●	●	
	Ceiling-Concealed	PLA-RP-EA-E						●		●	●	●	
		PEAD-M-JA(L)(2)								●	●	●	
		PEAD-RP-JAQ(L)-E							●	●	●		

PUMY-SP Series LEV Kit Connection Compatibility Table for PUMY-SP112/125/140

Series	I/U Type	Model Name	Capacity									
			15	18	20	22	25	35	42	50	60	71
M Series	Wall-mounted	MSZ-LN-VG2					●	●		●		
		MSZ-AP-VG(K)	●		●		●	●	●	●		
		MSZ-FH-VE2					●	●		●		
		MSZ-EF-VG(K)		●		●	●	●	●	●		
		MSZ-SF-VA	●		●							
		MSZ-AP-VF-E	●		●							
	1-way Cassette	MSZ-SF-VE3					●	●	●	●		
		MFZ-KT-VG					●	●		●		

PUMY-SP Series CITY MULTI Indoor Unit Compatibility Table for PUMY-SP112/125/140

Series	Type	Model Name	Capacity												
			P10	P15	P20	P25	P32	P40	P50	P63	P71	P80	P100	P125	P140
CITY MULTI series	1-way cassette	PMFY-P-VBM-E			●	●	●	●							
	2-way cassette	PLFY-P-VLMD-E			●	●	●	●					●	●	
		PLFY-M-VEM-E			●	●	●	●					●	●	●
	4-way cassette	PLFY-M-VEM6-E			●	●	●	●			●		●	●	●
		PLFY-P-VBM-E					●	●	●	●			●	●	●
		PLFY-P-VEM-E					●	●	●	●			●	●	●
		PLFY-P-VCM-E		●	●	●	●	●					●	●	●
	Ceiling-concealed	PLFY-P-VFM-E		●	●	●	●	●							
		PEFY-P-VMR-E-L/R			●	●	●	●							
		PEFY-P-VMS1-E		●	●	●	●	●		●					
		PLFY-P-VMA-E			●	●	●	●		●	●	●	●	●	●
		PEFY-M-VMA-A(1)			●	●	●	●		●	●	●	●	●	●
		PEFY-P-VMH(S)-E					●	●	●	●	●	●	●	●	●
		PEFY-P-VMH-E-F											●	●	●
	Ceiling-suspended	PEFY-P-VMHS-E-F											●	●	●
		PCFY-P-VKM-E	●						●		●		●	●	
	Wall-mounted	PKFY-P-VLM-E		●	●	●	●	●		●					
		PKFY-P-VBM-E		●	●	●									
		PKFY-P-VHM-E					●	●	●						
		PKFY-P-VKM-E									●		●		
	Built in	PDFY-P-VM-E			●	●	●	●		●	●	●	●	●	
		PFFY-P-VKM-E2			●	●	●	●		●	●	●	●	●	
	Floor-standing	PFFY-P-VLEM-E			●	●	●	●		●	●	●	●	●	
		PFFY-P-VLRM-E			●	●	●	●		●	●	●	●	●	
PFFY-P-VLRMM-E				●	●	●	●		●	●	●	●	●		
PFFY-P-VCM-E				●	●	●	●		●	●	●	●	●		
		Lossnay *	GUF-50/100RD(H)4												

*Do not connect Lossnay remote controller(s). (PZ-61DR-E, PZ-60DR-E, PZ-52SF-E, PZ-43SMF-E)



SMALL Y LINE

OUTDOOR UNITS - PUMY-P Y(V)KM 6(5)(-BS)



MORE QUIETNESS
THANKS TO THE NEW
FAN

CONNECTABLE
TO **ecodan** ATW
Renewable Heating Technology
MODULES FOR HOT
WATER PRODUCTION
UP TO 55°C

GEOMETRIC PIPING
LIMITATIONS
INCREASED

H.I.C. CIRCUIT (HEAT
INTER CHARGER)
FOR THE SUBCOOLING
CONTROL

HEATING OPERATION
RANGE EXTENDED UP
TO -20°C OUTDOOR
TEMPERATURE

TOP PERFORMANCE
AND COP > 4 ON THE
ENTIRE RANGE

POWER RANGE
4-5-6 HP
THREE-PHASE
AND SINGLE SIZE

NEW CHASSIS WITH
INCREASED HEAT
EXCHANGE SURFACE

INCREASED
RELIABILITY

CONNECTABLE TO
RESIDENTIAL AND
COMMERCIAL INDOOR
UNITS BY LEV-KIT AND
BRANCH BOX

NATIVE REPLACE
TECHNOLOGY
FUNCTION FOR THE
REPLACEMENT OF R22
SYSTEMS



New PUMY Y(V)KM 4(5) - The smallest, but with all the technology and efficiency of our bigger units

The SMALL Y (PUMY) series of outdoor units by Mitsubishi Electric, which now offers 7 different variants (with single and three-phase 4.5, 5 and 6 HP versions and a three-phase 8 HP version), is the ideal solution for large homes and medium-sized offices. These outdoor units may be connected to up to 12 indoor units of different type and power rating. This system offers exceptional savings in operating costs and is suitable for both residential and commercial applications.

Class-beating energy efficiency

The new SMALL Y (PUMY) series has been designed to offer extraordinary levels of energy efficiency in both summer (EER) and winter (COP) operation. The entire range scores **COP values above 4**, making these units usable even in regions where legislation sets more restrictive performance limitations.

Total comfort. Even at -20°C

The new SMALL Y (PUMY) series is now capable of operating in heating mode over an even broader temperature range (from -20 to +15 °C).

New chassis with larger heat exchange surface area

The new design of the SMALL Y (PUMY) series has made it possible to use a direct expansion coil with greater heat exchange surface area and density. Together with the introduction of the **Heat Inter Charger** overcooling circuit – a technological solution now appearing for the first time in units of this series – these improvements ensure superlative performance and extraordinary energy efficiency in cooling mode. The flat fin configuration of the coil and special Blue Fin treatment protect the

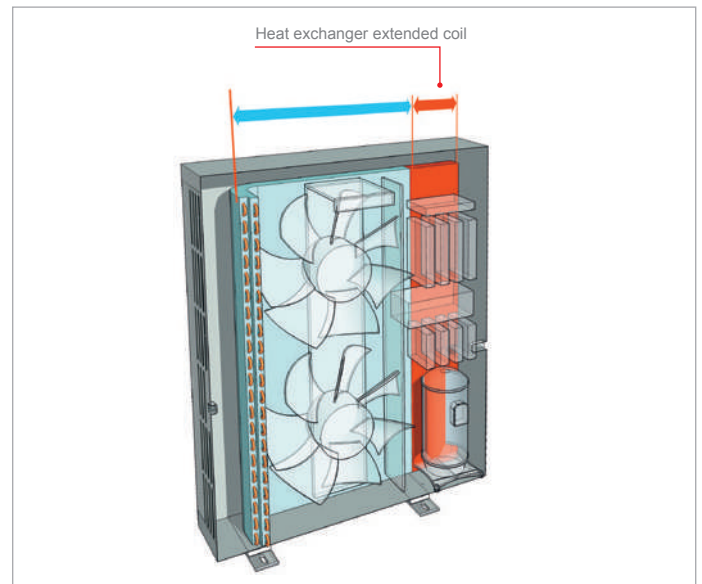

coil itself against corrosion, ensuring that the unit continues to function with the same outstanding thermal exchange efficiency and performance over time.

The power of a VRF, the elegance of a residential Multi-Split

With the **LEV KIT** and the new dedicated **Branch Box** (available as 3 and 5 connection versions), the outdoor units of the Small Y series can now be connected to the entire range of **residential and commercial** indoor units, with looks that are perfectly suited to applications (such as residential buildings and hotels) where design and elegance are decisive factors in the choice of indoor units.

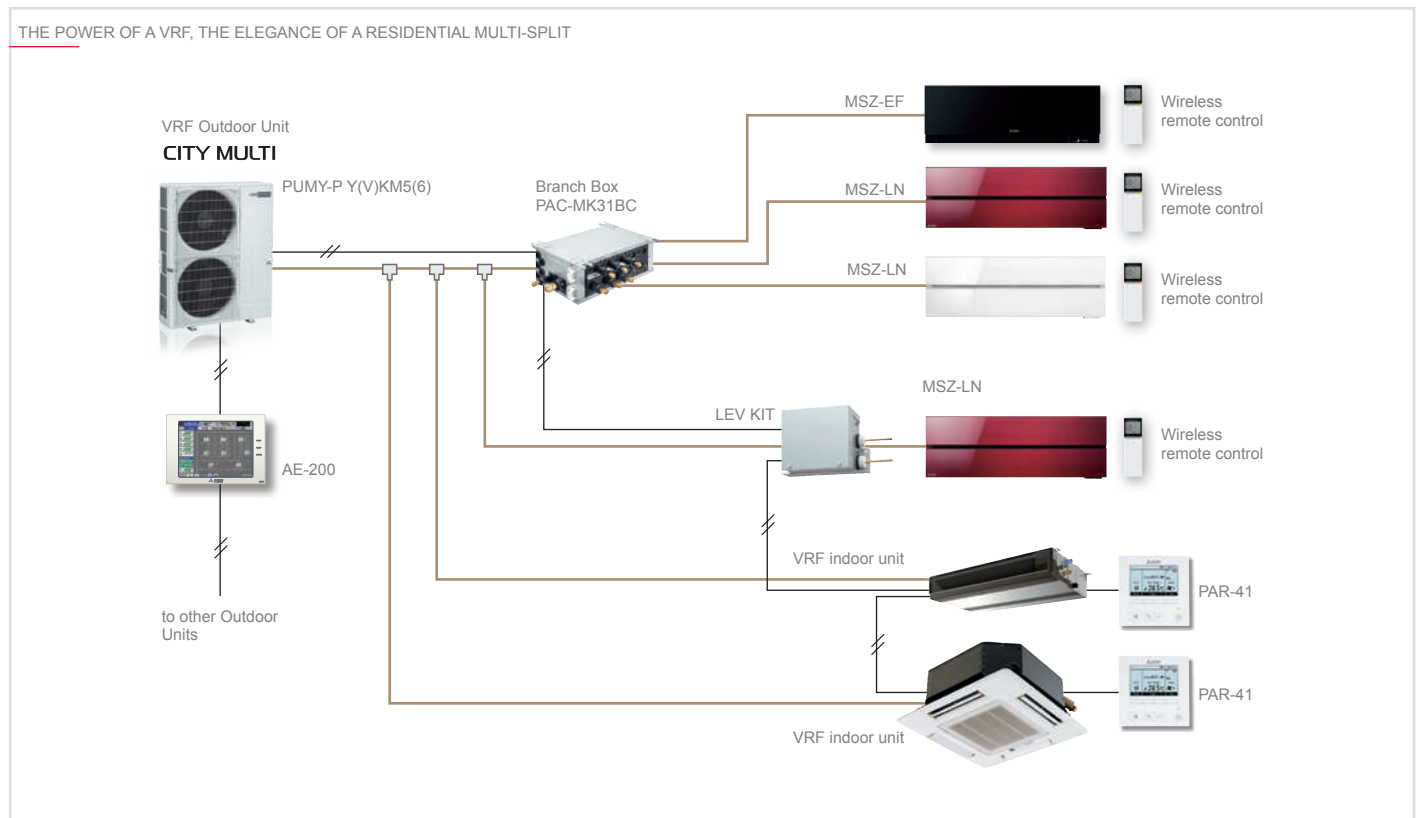

New Branch Boxes (3 or 5 connections) – Total flexibility

The new Branch Boxes are designed to offer the greatest configuration flexibility possible for the system. This makes it possible to create systems consisting entirely of CITY MULTI VRF units, systems with Residential/Commercial series indoor units only, or mixed systems with both types of unit.

Model	1 Branch Box		2 Branch Box	
	Branch Box ways	CITY MULTI Indoor units	Branch Box ways	CITY MULTI Indoor units
PUMY-P112	Max. 5	Max. 5	Max. 7	Max. 3
			Max. 8	Max. 2
PUMY-P125	Max. 5	Max. 5	Max. 8	Max. 3
PUMY-P140				

Mixed systems

SMALL Y series (PUMY) sizes 4.5-5-6 HP can be connected to **Ecodan HYDROBOX and HYDROTANK**, allowing mixed systems (domestic hot water, radiant panels or air heating and air cooling). Thanks to this feature the system can produce **hot water up to 55°C**.

Unparalleled silence

The new fans cut through the air more effectively and minimise turbulence, for superlative static overpressure with **minimum noise impact**. These fans generate a **10% higher outdoor air flow than the previous version** while operating at the same noise levels. Small Y (PUMY) is also capable of operating in “low noise” mode, reducing sound pressure levels by 2 dB. By connecting an external timer or switch to the fan, this mode can be set for specific time brackets during the day.

New fan

Diameter increased from 490 mm to 550 mm.

The new fan has longer, differently shaped blades to direct air more effectively, reduce turbulence and increase efficiency.

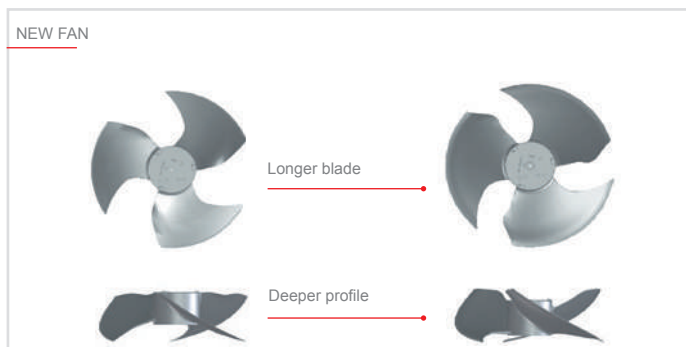

Total flexibility for installation and maintenance

With increased geometric limits for piping, the SMALL Y (PUMY) series offers unparalleled flexibility for installation.

INCREASED GEOMETRICAL LIMITS FOR PIPING	
PUMY P112-P125-P140 Y(V)KM4	
Total effective length	300 m
Effective length of a single circuit	150 m
Maximum vertical difference between indoor units	15 m
“Maximum vertical difference between indoor and outdoor units (with outdoor unit in lower position)”	40 m

New PUMY Y(V)KM with Replace Technology

The EU regulation 2037/2000/EC has banned the use of virgin HCFC refrigerants (R22) since 1/1/2010. As a result, in the event of a fault or even just a refrigerant leak in an air conditioning system using R22, it is no longer possible to recharge the system. With small to medium-sized installations in particular, the most cost effective solution is to replace the entire air conditioning system. This is because of the following reasons:

- New generation outdoor units with R410A are much more efficient, with lower electric power consumption;
- They are quieter and offer more effective air filtration;
- Taking advantage of tax rebates offered for replacing winter air conditioning systems will minimise the time necessary to recoup the initial outlay.

The main problem in replacing an existing air conditioner using R22 fluid with a system using new R410A refrigerant is posed by the residue of chlorine and mineral oils remaining in the existing piping onto which the air conditioner system containing R22 was connected. This residue is extremely harmful for the new air conditioner, and unless the circuit is flushed out extremely thoroughly, may degrade the new oil and/or cause obstructions in the refrigerant circuit and, as a result, lead to system malfunctions. Moreover, the diameters and thickness of the existing piping may not be compatible with the new units.

The **SMALL Y (PUMY) Lines** of outdoor units features **Mitsubishi Electric Replace Technology**, which allows the **existing piping to be used** without modification, even with piping with different diameters and wall thicknesses. By using exclusive HAB oil and special low friction technology for the compressor, the majority of our air conditioners may operate with the original piping, cutting installation times and costs and material costs while minimising environmental impact.

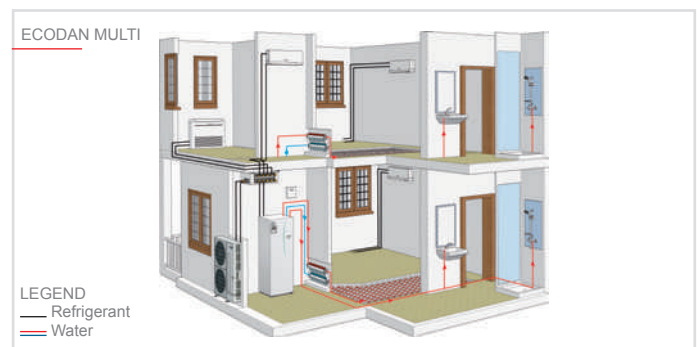

AC PRE-HEATING compressor pre-heating system

AC pre-heating system is used for the compressor. The pre-heat routine is based on the temperature of the refrigerant and of the compressor. AC control reduces power absorption in stand-by state, increasing seasonal efficiency.

Technical specifications				PUMY-P112VKM6(-BS)	PUMY-P125VKM6(-BS)	PUMY-P140VKM6(-BS)
MODEL				4.5	5.0	6.0
HP				4.5	5.0	6.0
Power	Phases/Voltage/Freq.	1-phase 220-230-240V 50Hz, 220-230V 60Hz				
Cooling	Nominal capacity*1	kW	12.5	14.0	15.5	
	Power absorption	kW	4.34	5.00	5.17	
	SEER		6.40	6.33	7.29	
	Operating temperature range	Indoor WB	°C	15.0~24.0°C	15.0~24.0°C	15.0~24.0°C
Outdoor DB*3*4		°C	-5.0~52.0°C	-5.0~52.0°C	-5.0~52.0°C	
Heating	Nominal capacity*2	kW	14.0	16.0	18.0	
	Power absorption	kW	3.04	3.74	4.47	
	SCOP		4.25	4.37	4.38	
	Operating temperature range	Indoor DB	°C	15.0~27.0°C	15.0~27.0°C	15.0~27.0°C
Outdoor WB		°C	-20.0~15.0°C	-20.0~15.0°C	-20.0~15.0°C	
Sound pressure*5		dB(A)	49/51	50/52	51/53	
Connectable indoor units	Total capacity	50~130 % of outdoor unit capacity				
	Model/Quantity	CITY MULTI	P10-P140, M20-M140/9	P10-P140, M20-M140/10	P10-P140, M20-M140/12	
		Branch Box	P15~P100/8	P15~P100/8	P15~P100/8	
		Mixed System	please refer to databook			
External diameter of refrigerant connectors	Liquid	mm	9.52	9.52	9.52	
	Gas	mm	15.88	15.88	15.88	
Fan air flow rate*6		m³/min	110	110	110	
External dimensions (HxLxW)		mm	1338 x 1050 x 330 (+40)	1338 x 1050 x 330 (+40)	1338 x 1050 x 330 (+40)	
Net weight		kg	123	123	123	
Ref. Charge R410A/CO ₂ Eq		kg/Tons	4.8/10.02	4.8/10.02	4.8/10.02	

Technical specifications				PUMY-P112YKM5(-BS)	PUMY-P125YKM5(-BS)	PUMY-P140YKM5(-BS)
MODEL				4.5	5.0	6.0
HP				4.5	5.0	6.0
Power	Phases/Voltage/Freq.	3-phase 380-400-415V 50Hz, 380V 60Hz				
Cooling	Nominal capacity*1	kW	12.5	14.0	15.5	
	Power absorption	kW	4.34	5.00	5.17	
	SEER		6.42	6.36	7.28	
	Operating temperature range	Indoor WB	°C	15.0~24.0°C	15.0~24.0°C	15.0~24.0°C
Outdoor DB*3*4		°C	-5.0~52.0°C	-5.0~52.0°C	-5.0~52.0°C	
Heating	Nominal capacity*2	kW	14.0	16.0	18.0	
	Power absorption	kW	3.49	4.06	4.63	
	SCOP		4.30	4.40	4.38	
	Operating temperature range	Indoor DB	°C	15.0~27.0°C	15.0~27.0°C	15.0~27.0°C
Outdoor WB		°C	-20.0~15.0°C	-20.0~15.0°C	-20.0~15.0°C	
Sound pressure*5		dB(A)	49/51	50/52	51/53	
Connectable indoor units	Total capacity	50~130 % of outdoor unit capacity				
	Model/Quantity	CITY MULTI	P10-P140, M20-M140/9	P10-P140, M20-M140/10	P10-P140, M20-M140/12	
		Branch Box	P15~P100/8	P15~P100/8	P15~P100/8	
		Mixed System	please refer to databook			
External diameter of refrigerant connectors	Liquid	mm	9.52	9.52	9.52	
	Gas	mm	15.88	15.88	15.88	
Fan air flow rate*6		m³/min	110	110	110	
External dimensions (HxLxW)		mm	1338 x 1050 x 330 (+40)	1338 x 1050 x 330 (+40)	1338 x 1050 x 330 (+40)	
Net weight		kg	125	125	125	
Ref. Charge R410A/CO ₂ Eq		kg/Tons	4.8/10.02	4.8/10.02	4.8/10.02	

*1,2 Nominal conditions

	Indoor	Outdoor	Pipe length	Level difference
Cooling	27°C DB/19°C WB	35°C DB	7.5m	0m
Heating	20°C DB	7°C DB/6°C WB	7.5m	0m

*3 10 to 52°C D.B. [50 to 126°F D.B.], when connecting following models: PKFY-P10/15/20/25/32VLM, PFFY-P20/25/32VLEM, PFFY-P20/25/32VLRM(M), PFFY-P20/25/32VKM, PFFY-P20/25/32VCM, PEFY-P25/32/40VMA3; and M-Series, S-Series, and P-Series type indoor unit.

*4 -15 to 52°C D.B. [50 to 126°F D.B.], when using an optional air protect guide [PAC-SH95AG-E]. However, this condition does not apply to the indoor unit listed in*3.

*5 Cooling mode/Heating mode

*6 External static pressure option is available (30 Pa/3.1 mmH₂O). To use this option, PAC-SJ71FM-E is needed.

*Nominal condition *1,2 are subject to ISO 15042.

*Due to continuing improvement, above specification may be subject to change without notice.

SMALL Y (HIGH CAPACITY) LINE

OUTDOOR UNITS - PUMY P200 YKM3(-BS) / PUMY P250-300 YBM2(-BS)



* P200 Model only

MORE QUIETNESS
THANKS TO THE NEW
FAN

GEOMETRIC PIPING
LIMITATIONS
INCREASED

H.I.C. CIRCUIT (HEAT
INTER CHARGER)
FOR THE SUBCOOLING
CONTROL

HEATING OPERATION
RANGE EXTENDED UP
TO -20°C OUTDOOR
TEMPERATURE

TOP PERFORMANCE
AND COP > 4



POWER RANGE
EXTENDED WITH THE
INTRODUCTION
OF THE NEW 8, 10, 12 HP
THREE-PHASE SIZE

NEW CHASSIS WITH
INCREASED HEAT
EXCHANGE SURFACE

INCREASED
RELIABILITY

CONNECTABLE TO
RESIDENTIAL AND
COMMERCIAL INDOOR
UNITS BY LEV-KIT AND
BRANCH BOX

NATIVE REPLACE
TECHNOLOGY
FUNCTION FOR THE
REPLACEMENT OF R22
SYSTEMS

The power and performance of a VRF with the compact dimensions of a multisplit

The new PUMY-P200YKM 8HP is the ideal solution for all applications where there can be no compromise in efficiency, power and installation flexibility – even where installation space is limited.

The power of a VRF, the elegance of a residential Multi-Split

With the use of the **LEV KIT** and **Branch Box** (available as 3 and 5 connection versions) the outdoor units of the Small Y series in **8 HP** size can now be connected to the entire range of indoor units of the **residential and commercial series**, with looks that are perfectly suited to applications (residential and hotel buildings) where design and elegance are decisive factors in the choice of indoor units.

Branch Box (3-5 ports) - Total flexibility

New Branch Box grants high flexibility in system design and indoor unit choice. It is possible to connect Residential/Commercial units and/or CITY MULTI VRF units, realizing mixed systems with both types.

Note: PUMY-P200YKM(2)3 to Branch Box connection is **only available in AtA configuration**.

Model	1 Branch Box		2 Branch Box	
	Branch Box ways	CITY MULTI Indoor Units	Branch Box ways	CITY MULTI Indoor Units
PUMY-P200	Max. 5	Max. 5	Max. 8	Max. 3

*The maximum total capacity of the units that can be connected to each branch box is 20.2kW

Technical specifications

MODEL		PUMY-P200YKM3(-BS)		
HP	8			
Power	Phases/Voltage/Freq.	3-phase 380-400-415V 50Hz		
Cooling	Capacity ¹	kW	22.4	
	Power input	kW	7.18	
	SEER		6.67	
	Temperature operating field	Indoor WB	°C	15.0~24.0°C
Outdoor DB ^{3,4}		°C	-5.0~52.0°C	
Heating	Capacity ²	kW	25.0	
	Power input	kW	5.85	
	SCOP		3.66	
	Temperature operating field	Indoor DB	°C	15.0~27.0°C
Outdoor WB		°C	-20.0~15.0°C	
Sound power level ⁵		dB(A)	57/61	
Connectable indoor units	Model/Quantity	CITY MULTI		50~130 % of outdoor unit capacity
		P10-P200, M20-M140/12		
		Branch Box		P15~P100/8
		Mixed System		please refer to databook
Ø Ref. piping	Liquid/Gas	mm	9.52 ⁶ /19.05	
External dimensions (HxLxW)		mm	1338 x 1050 x 330 (+40)	
Net weight		kg	141	
Ref. Charge R410A/CO ₂ Eq		kg/Tons	7.3/15.24	

^{1,2} Nominal conditions

	Indoor	Outdoor	Pipe length	Level difference
Cooling	27°C DB/19°C WB	35°C DB	7.5m	0m
Heating	20°C DB	7°C DB/6°C WB	7.5m	0m

³ 10 to 52°C, when connecting following models: PKFY-P10/15/20/25/32VLM, PFFY-P20/25/32VLEM, PFFY-P20/25/32VLRM(M), PFFY-P20/25/32VKM, PFFY-P20/25/32VCM, PEFY-P40/63/VMA3-E; and M-Series, S-Series, and P-Series type indoor unit.

⁴ -15 to 52°C, when using an optional air protect guide [PAC-SH95AG-E]. However, this condition does not apply to the indoor unit listed in³.

⁵ Cooling mode/Heating mode

⁶ Liquid pipe diameter: 12.7 mm, in case of further piping length is longer than 60 m.

*Nominal condition ^{1,2} are subject to ISO 15042.

*Due to continuing improvement, above specification may be subject to change without notice.

The power and performance of a VRF with the compact dimensions of a multisplit

The new PUMY-P250/300 YKB 10-12 HP is the ideal solution for all applications where there can be no compromise in efficiency, power and installation flexibility – even where installation space is limited.

Model	1 Branch Box		2 Branch Box		3 Branch Box	
	Branch Box ways	CITY MULTI Indoor Units	Branch Box ways	CITY MULTI Indoor Units	Branch Box ways	CITY MULTI Indoor Units
PUMY-P250	Max. 5	Max. 25	Max. 10	Max. 23	Max. 12	Max. 22
PUMY-P300	Max. 5	Max. 25	Max. 10	Max. 23	Max. 12	Max. 22

*The maximum total capacity of the units that can be connected to each branch box is 20.2kW

The power of a VRF, the elegance of a residential Multi-Split

With the use of the **LEV KIT** and **Branch Box** (available as 3 and 5 connection versions) the outdoor units of the Small Y series in **10/12 HP** size can now be connected to the entire range of indoor units of the **residential and commercial series**, with looks that are perfectly suited to applications (residential and hotel buildings) where design and elegance are decisive factors in the choice of indoor units.

Installation flexibility

The 10 and 12HP models introduce further installation flexibility by ensuring connection of the refrigerant also from the rear of the unit, making these models adaptable to all application requirements.

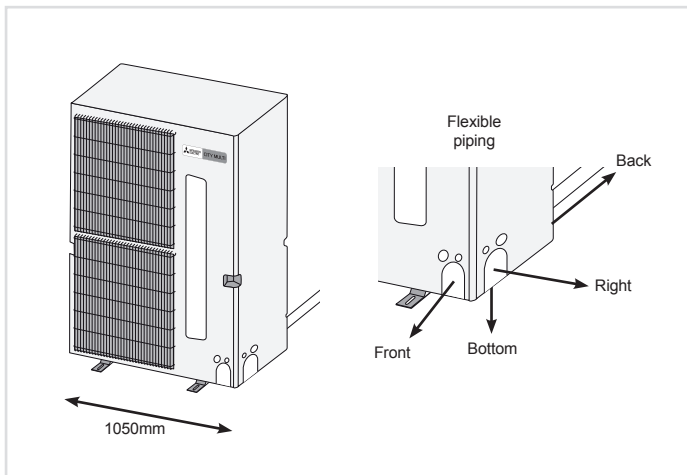

Branch Box (3-5 ports) - Total flexibility

New Branch Box grants high flexibility in system design and indoor unit choice. It is possible to connect Residential/Commercial units and/or CITY MULTI VRF units, realizing mixed systems with both types.

Note: PUMY-P250/300 YBM to Branch Box connection is **only available in AtA configuration**.

The new 10 and 12HP models

The SMALL Y Line gets enriched by the addition of new models (10 and 12HP) in response to the increasing market need for a compact machine that covers bigger capacity.

The PUMY P250/300 YBM outdoor units are available in a single version with three-phase power supply, double fan structure, side-flow and with different sizes depending on the model. Also available in -BS version, with anti-saline treatment.

Side Flow vs Top Flow

Side-flow outdoor units have a smaller footprint and volume than Top-flow units.

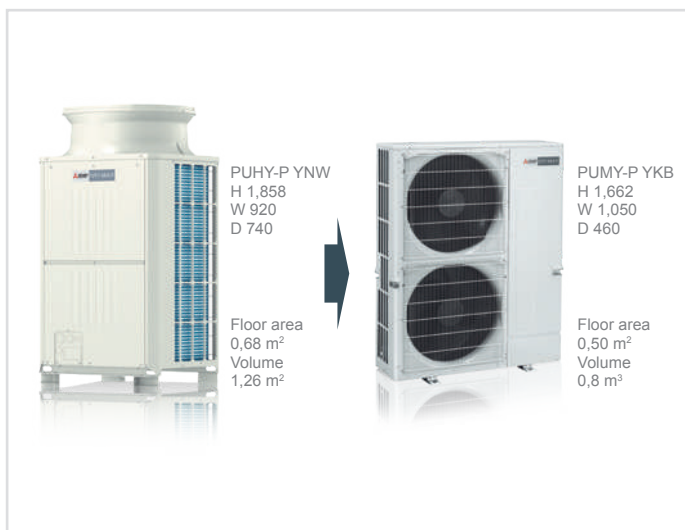

Technical specifications

MODEL			PUMY-P250YBM2(-BS)	PUMY-P300YBM2(-BS)
HP			10	12
Power	Phases/Voltage/Freq.		3-phase, 380-400-415V, 50Hz	
Cooling	Capacity*1		kW	28.0
	Power input		kW	8.21
	SEER			6,28
	Temperature operating field	Indoor WB	°C	15.0 to 24.0°C
Outdoor DB*3*4		°C	-5.0 to 52.0°C	
Heating	Capacity*2		kW	31.5
	Power input		kW	7.91
	SCOP			4,22
	Temperature operating field	Indoor WB	°C	15.0 to 27.0°C
Outdoor DB		°C	-20.0 to 15.0°C	
Sound power level*5			dB(A)	55/61
Connectable indoor units			50~130% of kW outdoor unit capacity	
	Model/Quantity	CITY MULTI		P10-P250/30
		Branch Box		P15~P100/12
		Mixed System		please refer to databook
Ø Ref. piping	Liquid/Gas	mm	9.52/22.4*5	12.7/22.4*5
External dimensions (HxLxW)			mm	1662 × 1050 × 460 (+45)
Net weight			kg	192
Ref. Charge R410A/CO ₂ Eq			kg/Tons	9.3/19.41

*1,2 Nominal conditions

	Indoor	Outdoor	Pipe length	Level difference
Cooling	27°C DB/19°C WB	35°C DB	7.5m	0m
Heating	20°C DB	7°C DB/6°C WB	7.5m	0m

*3 10 to 52°C, when connecting following models: PKFY-P10/15/20/25/32VLM, PFFY-P20/25/32VKM, PFFY-P20/25/32VCM, PFFY-P20/25/32VLEM, PEFY-P63/71/80VMA3-E; and M series type indoor unit.

*4 -15 to 52°C, when using an optional air protect guide [PAC-SK21AG-E]. However, this condition does not apply to the indoor unit listed in *3.

*5 Liquid pipe diameter: 12.7mm, when further piping length is longer than 90m, and when PEFY-P200 or P250 is connected.

*6 It is possible to set the External static pressure to 30 Pa by Dip Switch.

*Nominal conditions *1, *2 are subject to ISO15042.

*Due to continuing improvement, above specification may be subject to change without notice.

PUMY-P Series Branch Box Connection Compatibility Table for PUMY-P112/125/140/200

Series	Type	Model Name	Capacity										
			15	18	20	22	25	35	42	50	60	71	100
M Series	Wall-Mounted	MSZ-LN+VG2					●	●		●			
		MSZ-AP+VG(K)	●		●		●	●	●	●			
		MSZ-FH+VE2					●	●		●			
		MSZ-EF+VE		●		●	●	●	●	●			
		MSZ-EF+VG(K)		●		●	●	●	●	●			
		MSZ-SF+VA	●		●								
		MSZ-AP+VF	●		●								
	Floor-Standing	MFZ-KT+VG					●	●		●			
		MFZ-KJ+VE-E					●	●		●			
		MLZ-KP+VF					●	●		●			
1-way Cassette	MLZ-KA+VA-E					●	●		●				
	SEZ-M+DA(L)2					●	●		●	●	●		
	SEZ-KD+VA-E					●	●		●	●	●		
S Series	Ceiling-Concealed	SEZ-M+DA(L)2-E *1					●	●		●	●	●	
		SLZ-M+FA(2)	●				●	●		●	●	●	
	2x2 Cassette	SLZ-KF+VA-E					●	●		●			
		PCA-M+KA(2)						●		●	●	●	
P Series	Ceiling-Suspended	PCA-RP+KAQ-E						●		●	●	●	
		PLA-M+EA(2)						●		●	●	●	
	4-way Cassette	PLA-RP+EA-E						●		●	●	●	
		PEAD-M+JA(L)								●	●	●	
	Ceiling-Concealed	PEAD-RP+JA(L)Q-E								●	●	●	
		PEAD-M+DA(L)2 *1								●	●	●	

(1) Connectable outdoor units are PUMY-P112/125/140VKM6(YKM5) only.

PUMY-P Series LEV Kit Connection Compatibility Table for PUMY-P112/125/140/200

Series	I/U Type	Model Name	Capacity									
			15	18	20	22	25	35	42	50	60	71
M Series	Wall-mounted	MSZ-LN+VG2					●	●		●		
		MSZ-AP+VG(K)	●		●		●	●	●	●		
		MSZ-FH+VE2					●	●		●		
		MSZ-EF+VG(K)		●		●	●	●	●	●		
		MSZ-SF+VA	●		●							
	Floor-Standing	MFZ-KT+VG					●	●		●		

PUMY-P Series CITY MULTI Indoor Unit Compatibility Table for PUMY-P112/125/140

Series	Type	Model Name	Capacity													
			P10	P15	P20	P25	P32	P40	P50	P63	P71	P80	P100	P125	P140	P200
CITY MULTI series	1-way cassette	PMFY-P+VBM-E			●	●	●	●								
	2-way cassette	PLFY-P+VLM-E			●	●	●	●	●	●		●	●	●		
		PLFY-M+VEM-E			●	●	●	●	●	●		●	●	●		
	4-way cassette	PLFY-M+VEM6-E			●	●	●	●	●	●	●	●	●	●		
		PLFY-P+VFM-E		●	●	●	●	●	●							
	Ceiling-concealed	PEFY-P+VMR-E-L/R			●	●	●	●								
		PEFY-P+VMS1-E		●	●	●	●	●	●	●						
		PEFY-M+VMA-A(1)			●	●	●	●	●	●	●	●	●	●	●	
		PEFY-P+VMHS-E							●	●	●	●	●	●	●	
	Ceiling-suspended	PEFY-P+VMHS-E-F												●	●	
		PCFY-P+VKM-E							●	●	●			●	●	
	Wall-mounted	PKFY-P+VLM-E	●	●	●	●	●	●	●							
		PKFY-P+VKM-E								●	●			●		
	Floor-standing	PFFY-P+VKM-E2			●	●	●	●								
		PFFY-P+VLEM-E			●	●	●	●	●	●						
		PFFY-P+VLRM-E			●	●	●	●	●	●						
		PFFY-P+VLRMM-E			●	●	●	●	●	●						
		PFFY-P+VCM-E			●	●	●	●	●	●						
ATW	PWFY-P+VM-E1 *1														●	
Lossnay *2		GUF-50/100RD(H)4														

*1 Note that connection is not allowed inside EU countries and UK.

PWFY can not connect to PUMY-P200YKM2.

*2 Do not connect Lossnay remote controller(s). (PZ-61DR-E, PZ-60DR-E, PZ-52SF-E, PZ-43SMF-E)

PUMY-P Series CITY MULTI Indoor Unit Compatibility Table for PUMY-P200

Series	Type	Model Name	Capacity													
			P10	P15	P20	P25	P32	P40	P50	P63	P71	P80	P100	P125	P140	P200
CITY MULTI series	1-way cassette	PMFY-P-VBM-E			•	•	•	•								
	2-way cassette	PLFY-P-VLMD-E			•	•	•	•	•	•			•	•	•	
		PLFY-M-VEIM-E			•	•	•	•	•	•			•	•	•	
	4-way cassette	PLFY-M-VEIM6-E			•	•	•	•	•	•	•		•	•	•	
		PLFY-P-VFM-E		•	•	•	•	•	•	•						
	Ceiling-concealed	PEFY-P-VMR-E-L/R			•	•	•									
		PEFY-P-VMS1-E		•	•	•	•	•	•	•						
		PEFY-M-VMA-A(1)			•	•	•	•	•	•	•	•	•	•	•	
		PEFY-P-VMHS-E							•	•	•	•	•	•	•	•
	Ceiling-suspended	PEFY-P-VMHS-E-F														•
		PCFY-P-VKM-E							•		•			•	•	
	Wall-mounted	PKFY-P-VLM-E	•	•	•	•	•	•	•							
		PKFY-P-VKM-E									•			•		
	Floor-standing	PFFY-P-VKM-E2			•	•	•	•								
		PFFY-P-VLEM-E			•	•	•	•		•	•					
		PFFY-P-VLRM-E			•	•	•	•		•	•					
		PFFY-P-VLRMM-E			•	•	•	•		•	•					
PFFY-P-VCM-E				•	•	•	•		•	•						
Lossnay *2		GUF-50/100RD(H)4														

*1 Note that connection is not allowed inside EU countries and UK.
 PWFY can not connect to PUMY-P200YKM2.
 *2 Do not connect Lossnay remote controller(s). (PZ-61DR-E, PZ-60DR-E, PZ-52SF-E, PZ-43SMF-E)

PUMY-P Series Branch Box/LEV Kit Connection Compatibility Table for PUMY-P250/300

Series	I/U Type	Model Name	Capacity							
			15	18	20	22	25	35	42	50
M Series	Wall-mounted	MSZ-LN-VG2					•	•		•
		MSZ-AP-VG(K)	•		•		•	•	•	
		MSZ-FH-VE2					•	•		•
		MSZ-EF-VG(K)		•		•	•	•	•	
	Floor-Standing	MFZ-KT-VG					•	•		•

PUMY-P Series CITY MULTI Indoor Unit Compatibility Table for PUMY-P250/300

Series	Type	Model Name	Capacity													
			P10	P15	P20	P25	P32	P40	P50	P63	P71	P80	P100	P125	P140	P200
CITY MULTI series	1-way cassette	PMFY-P-VBM-E			•	•	•	•								
	2-way cassette	PLFY-P-VLMD-E			•	•	•	•	•	•			•	•	•	
		PLFY-M-VEIM-E			•	•	•	•	•	•	•		•	•	•	
	4-way cassette	PLFY-M-VEIM6-E			•	•	•	•	•	•	•		•	•	•	
		PLFY-P-VFM-E		•	•	•	•	•	•							
	Ceiling-concealed	PEFY-P-VMR-E-L/R			•	•	•									
		PEFY-P-VMS1-E		•	•	•	•	•	•	•						
		PEFY-M-VMA-A			•	•	•	•	•	•	•	•	•	•	•	
		PEFY-P-VMA-A1			•	•	•	•	•	•	•	•	•	•	•	
	Ceiling-suspended	PEFY-P-VMHS-E							•	•	•	•	•	•	•	
		PEFY-P-VMHS-E-F														•
	Wall-mounted	PCFY-P-VKM-E							•		•			•	•	
		PKFY-P-VLM-E	•	•	•	•	•	•	•							
	Floor-standing	PKFY-P-VKM-E									•			•		
		PFFY-P-VKM-E2			•	•	•	•								
		PFFY-P-VLEM-E			•	•	•	•		•	•					
	PFFY-P-VCM-E			•	•	•	•		•	•						
Lossnay *2		GUF-50/100RD(H)4														

*1 Do not connect Lossnay remote controller(s). (PZ-61DR-E, PZ-60DR-E, PZ-52SF-E, PZ-43SMF-E)

Y ZUBADAN LINE

OUTDOOR UNITS - Heat Pump - PUHY HP Y(S)NW-A



NEW FOUR-SIDED BATTERY

STATIC PRESSURE OF FAN INCREASED UP TO 80 PA.

CITY MULTI

NEW FAN WITH LOW FRICTION PROFILE



COMPRESSOR OPTIMISED WITH "MULTI-POR" TECHNOLOGY

NEW AUTO-SHIFT MODE

NEW AUTO-SHIFT MODE PREHEAT DEFROST FUNCTION

ADVANCED ETC CONTROL OF EVAPORATION TEMPERATURE.

FLEXIBLE NOISE SETTING

Bringing a year round comfort solutions to extreme climates

CITY MULTI ZUBADAN-Series combines the ultimate in application flexibility and powerful cooling and heating capabilities to deliver precise comfort even in the coldest days of the year down to -30°C. The new ZUBADAN-Series that has new, larger-capacity compressors with an injection function in the suction chamber is capable of running at the rated heating capacity down to -20°C. In addition, the guaranteed outside temperature range of heating operation is expanded down to -30°C.

Reliable heating performance

The improved operating performance in low outside temperatures contributes to comfortable heating in cold weather.

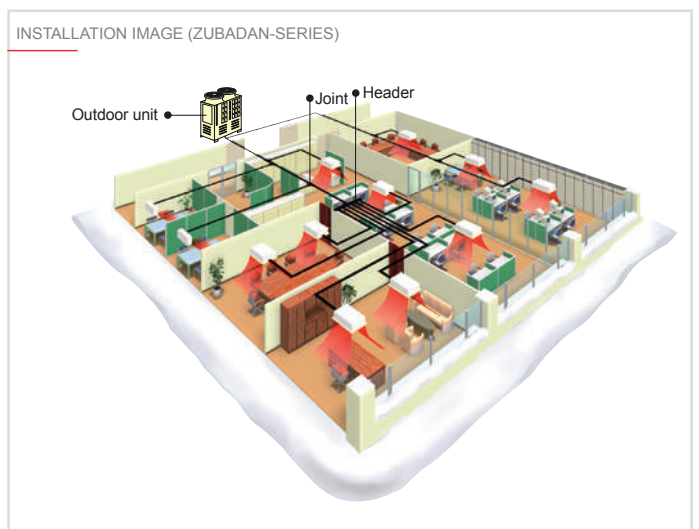
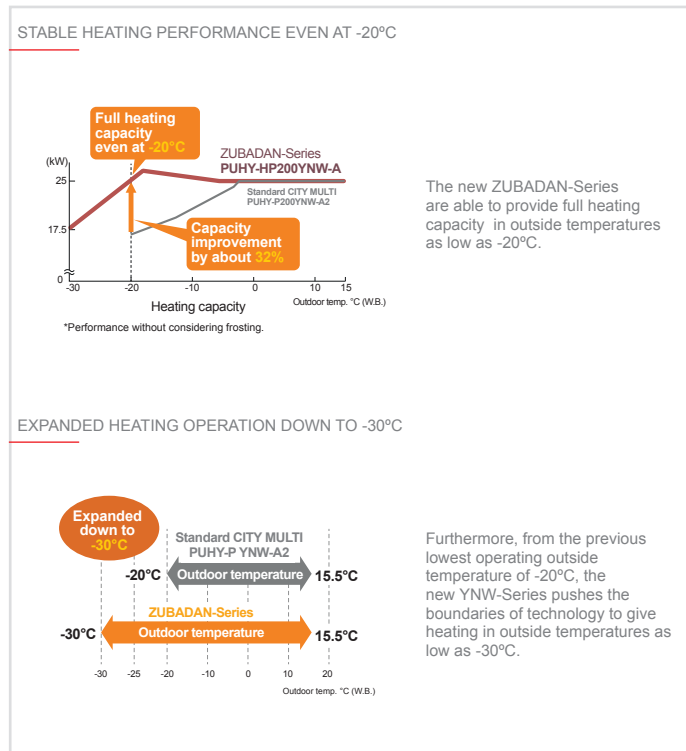

Energy saving

The ZUBADAN-Series delivers high energy-saving performance throughout the year. The improved compressor with the latest technologies realizes both reliable performance and highly efficient operation. The highest SCOP 3.74 is achieved by the HP250 model.

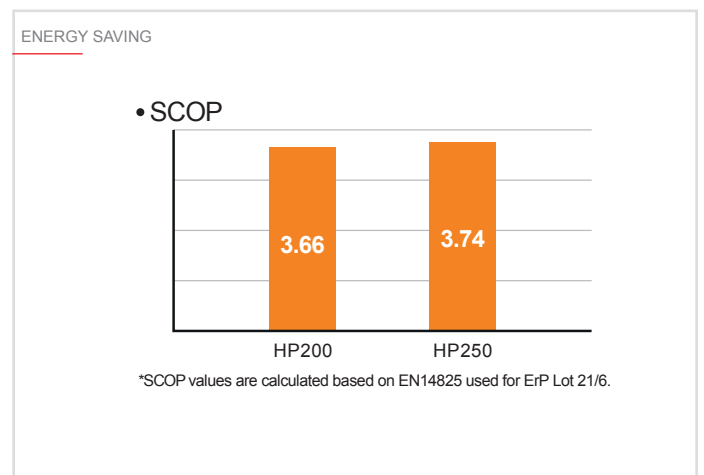

New design

The structure and design have been revised. The appearance is more sophisticated which can enhance the design of building.

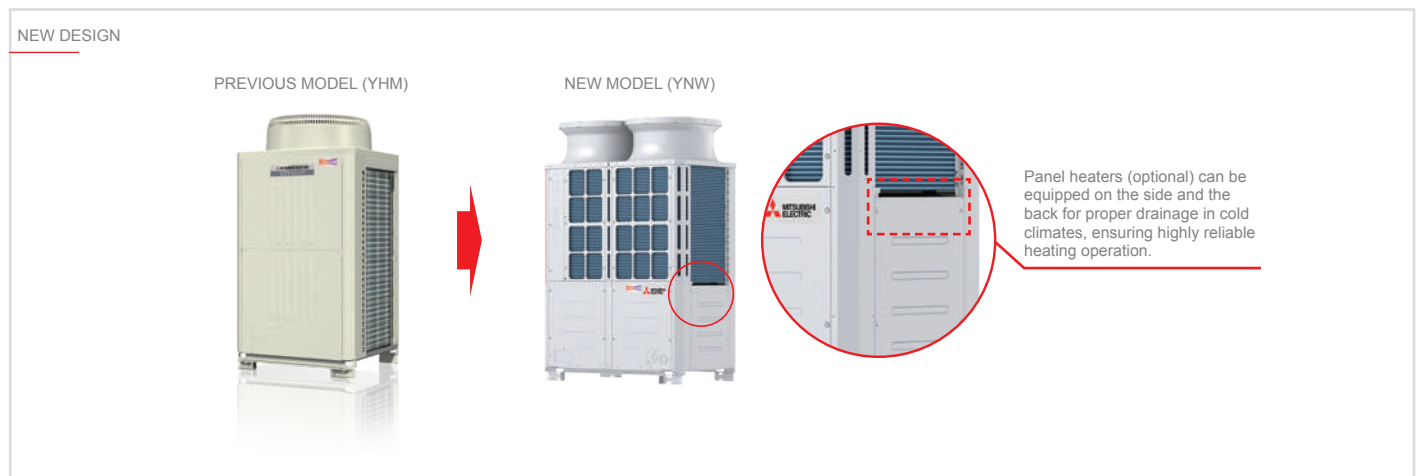

Expanded options for external static pressure settings

The new models (YNW) offer the static pressure options of 0, 30, 60, and 80 Pa, while previous models (YHM) had maximum external static pressure of 60 Pa. This facilitates installation of the unit on each floor of a high-rise building or on balconies.

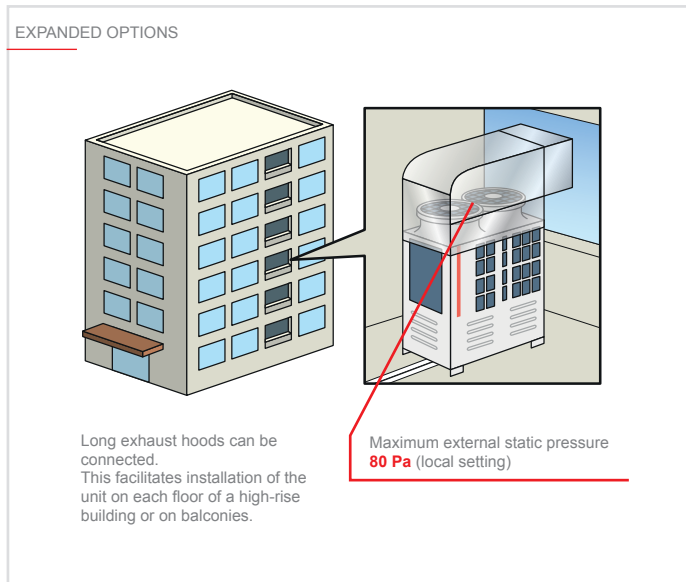

Usable in an application with a large vertical separation of up to 90 meters

A height difference of up to 90 m from the outdoor unit to the indoor unit can be supported with no extra-cost options. This increases design flexibility and facilitates installation of these units even in high-rise buildings.

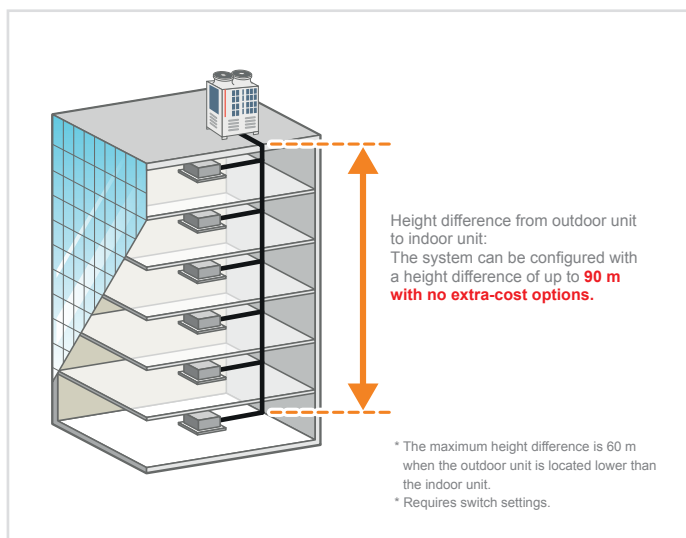

Change refrigerant oil of compressor

The new ZUBADAN-Series uses MEL46EH refrigerant oil instead of the conventional MEL32, for greater resistance to low temperatures and steady circulation even in cold environments.



Suction chamber injection mechanism

The reliable heating operation of ZUBADAN-Series is supported by a suction chamber injection mechanism. This mechanism injects liquid refrigerant into the suction chamber and suppresses the temperature rise of the discharge gas. Owing to this technology, the ZUBADAN-Series can perform heating operation even at an outside temperature as low as -30°C. Furthermore, heating performance at low outside temperatures is improved, because the rated capacity is maintained even at outside temperatures down to -20°C.

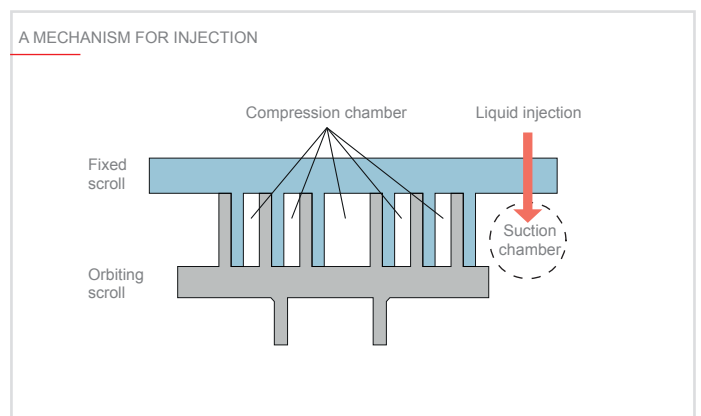

Multi-port mechanism

Efficient partial load operation is realized by avoiding overcompression. With the scroll compressor, the distance of the compression process in the scroll is usually fixed, so over-compression occurs during low loads and low rotation. The new compressor is equipped two sub-ports in addition to the conventional discharge port to reduce this over-compression loss

during low loads. In operation conditions having a low compression rate, the distance in the compression process is kept short by that successfully avoiding unnecessary compression, and contributing to efficient partial load operation.

MULTI-PORT MECHANISM

Conventional structure
There was only one discharge port in the center and regardless of the air conditioning loads, the refrigerant was compressed up to the center part of scroll, then discharged with constant pressure. This means that the refrigerant tends to be compressed to higher than necessary pressure during low loads.

There is only one discharge port and refrigerant is discharged with constant pressure regardless of loads.

Image of refrigerant pressure (medium loads)

New structure
The new compressor is equipped two sub-ports in addition to the discharge port at the center, and it realizes discharge according to air conditioning loads. The suppression of over-compression contributes to improve the operation efficiency of partial load.

Some discharge ports are equipped and refrigerant is discharged by the pressure according to loads without useless.

Image of refrigerant pressure

The new structure, multi-port compressor which newly equipped two sub-ports which open and close according to loads, discharges refrigerant from sub-port during the partial load operation.

Conventional structure

		Operation pattern	
		Partial load	Rating, high pressure difference
Main port	Valve ①	open	open

New structure • Multi-port

		Operation pattern	
		Partial load	Rating, high pressure difference
Main port	Valve ①	open	open
Sub port	Valve ②	open	close
Sub port	Valve ③	open	close

Centrifugal force canceling mechanism (8HP)

The latest structure has been mounted to suppress the centrifugal force. This mechanism successfully suppresses the centrifugal force generated at the scroll section, reduces refrigerant leakage losses, and increases the compressor efficiency. The maximum rotational speed has been increased from the conventional 120rps to 140rps. This mechanism also speeds up the start of operation, and enables operations such as preheat defrost and the smooth auto-shift startup mode.

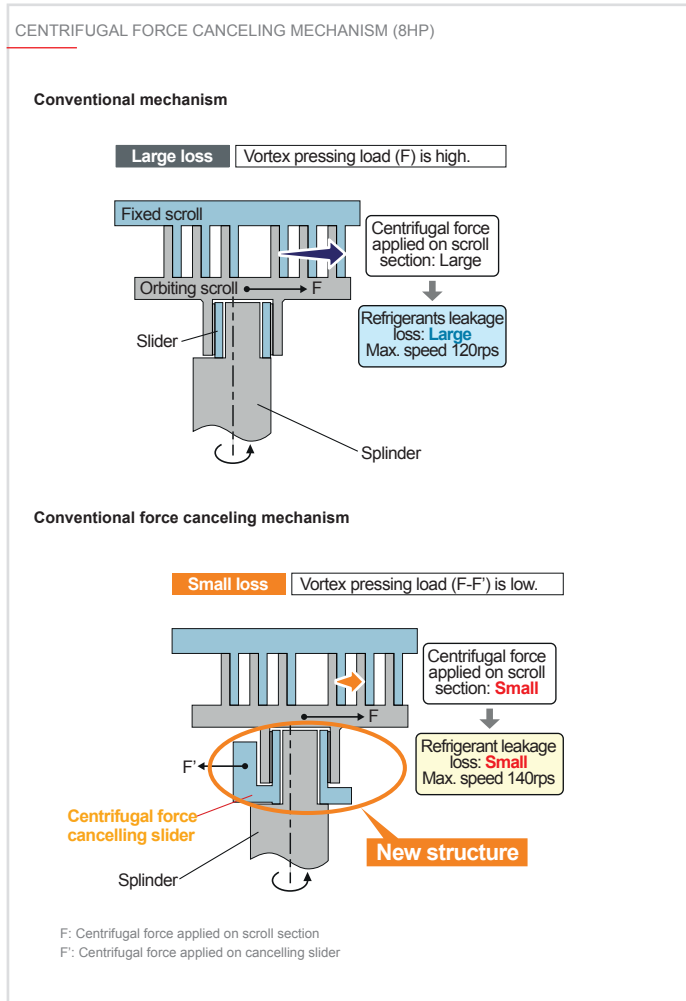

Improved high-efficiency motor

The insulator section that traditionally created a dead space is eliminated by insulating the motor's stator film. Since winding can be set in that section, the winding area can be increased by approx. 9%. The wire diameter has also been increased by two ranks, so the resistance between terminals is reduced, and the insulation distance is shorter. This improves the motor's operation performance and contributes to high-efficiency operation of the compressor.

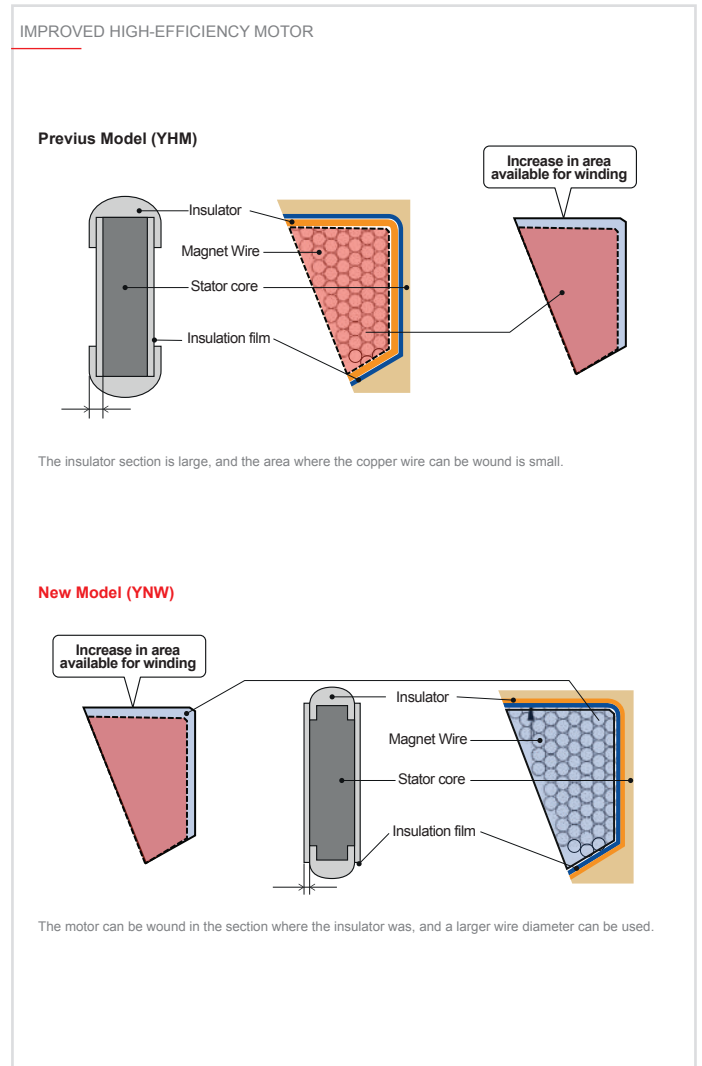

Key Technologies

--	--	--	--	--	--	--	--	--	--	--	--	--	--

Technical specifications

MODEL			PUHY-HP200YNW-A	PUHY-HP250YNW-A	PUHY-HP400YSNW-A	PUHY-HP500YSNW-A
HP			8	10	12	14
Modules			PUHY-HP200YNW-A	PUHY-HP250YNW-A	PUHY-HP(200+200)YNW-A	PUHY-HP(250+250)YNW-A
Power supply	V/Hz/n ^o		3-phase 4-wire 380-400-415 V 50/60 Hz			
Cooling	Capacity (nominal) ^{*1}	kW	22,4	28,0	44,8	56,0
	Power input (nominal)	kW	6,45	7,69	13,33	15,86
	SEER		6,52	6,49	6,33	6,7
	Temperature operating field	Indoor WB	°C	15.0~24.0 °C	15.0~24.0 °C (59~75 °F)	15.0~24.0 °C (59~75 °F)
Outdoor DB		°C	-5.0~52.0 °C	-5.0~52.0 °C (23~126 °F)	-5.0~52.0 °C (23~126 °F)	-5~+52
Heating	Capacity (nominal) ^{*2} / Capacity (max) ^{*2}	kW	22,4/25,0	28,0/31,5	44,8/ 50,0	56,0/63,0
	Power input (nominal)/ Power input (max)	kW	5,12/6,11	6,73/8,09	10,59/12,62	13,89/16,71
	SCOP		3,66	3,74	3,55	3,62
	Temperature operating field	Indoor DB	°C	15.0~27.0 °C	15.0~27.0 °C	15.0~27.0 °C
Outdoor WB		°C	-30.0~15.5 °C	-30.0~15.5 °C	-30.0~15.5 °C	-30.0~15.5 °C
Sound level ^{*4,5}	Sound pressure (Sound power) level	dB(A)	53.5 / 54.0 (73 / 73)	56.0 / 57.5 (75/77)	57.0 / 57.5 (77/77)	59,5/61,0 (79/81)
Connectable indoor units	Total Capacity		50~130% of outdoor unit capacity	50~130% of outdoor unit capacity	50~130% of outdoor unit capacity	50~130% of outdoor unit capacity
	Model/Quantity	CITY MULTI	P10~P250, M20~M140/1~20	P10~P250, M20~M140/1~25	P10~P250, M20~M140/1~40	P10~P250, M20~M140/1~50
Ø Ref. piping diameter	Liquid	mm	9,52	9,52	12,7	15,88
	Gas	mm	22,2	22,2	28,58	28,58
Fan ^{*6}	Type x quantity		Propeller fan x 2	Propeller fan x 2	Propeller fan x 4	Propeller fan x 4
	Air flow	m ³ /min	190	210	190+190	210+210
Compressor	Type		Inverter scroll hermetic			
	Motor output	kW	3,8	4,5	3,8	4,5
External dimensions	H(H ⁺)xWxD	mm	1858(1798)x1240x740	1858(1798)x1240x740	1858(1798)x1240x740 1858(1798)x1240x740	1858(1798)x1240x740 1858(1798)x1240x740
	Net weight	kg	274	294	274+274	294+294
Refrigerant	Ref. Charge R410	kg	9,8	10,8	19,6	21,6
	CO ₂ eq. ^{*8}	Tons	20,46	22,55	40,92	45,10

^{*1,2} Nominal conditions

	Indoor	Outdoor	Pipe length	Level difference
Cooling	27°C DB/19°C WB	35°C DB	7.5m	0m
Heating	20°C DB	7°C DB/6°C WB	7.5m	0m

^{*3} Eurovent registered

^{*4} Cooling mode / Heating mode

^{*5} The sound pressure level measured by the conventional method in JIS for reference purpose.

^{*6} External static pressure option is available (30 Pa, 60 Pa, 80 Pa/3.1 mmH₂O, 6.1 mmH₂O, 8.2 mmH₂O).

Consult your dealer about the specification when setting External static pressure option.

^{*}Due to continuing improvement, above specifications may be subject to change without notice.

Y NEXT STAGE LINE

OUTDOOR UNITS - PUHY-(E)P Y(S)NW-A2(-BS)



NEW FOUR-SIDED BATTERY

STATIC PRESSURE OF FAN INCREASED UP TO 80 PA.

CITY MULTI

NEW FAN WITH LOW FRICTION PROFILE

COMPRESSOR OPTIMISED WITH "MULTI-POR" TECHNOLOGY

NEW AUTO-SHIFT MODE

NEW AUTO-SHIFT MODE PREHEAT DEFROST FUNCTION

ADVANCED ETC CONTROL OF EVAPORATION TEMPERATURE.

FLEXIBLE NOISE SETTING

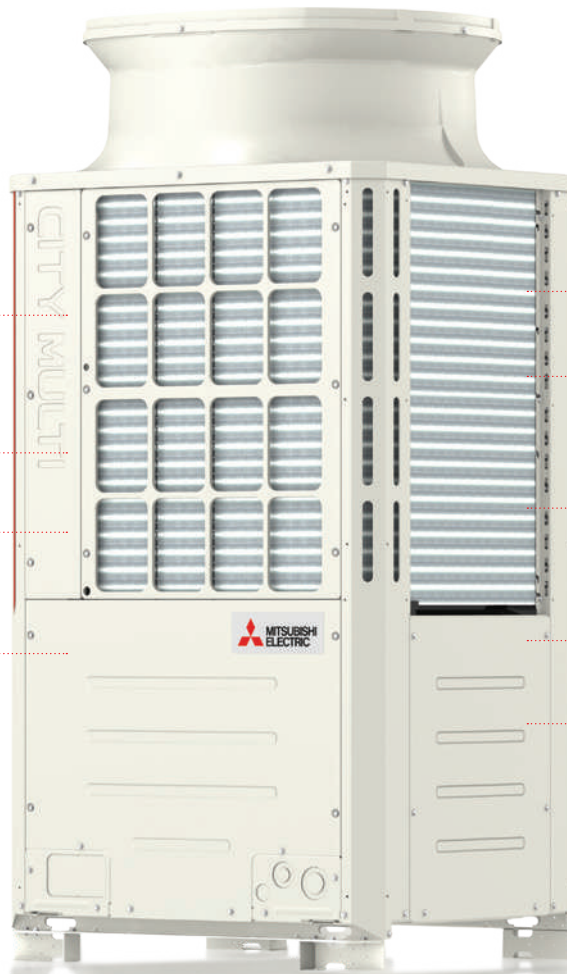

New design

The new outdoor units of the YNW series use a four-sided heat exchanger close to the top of the case near the fan. This technological and construction choice makes it possible to increase heat exchange efficiency.

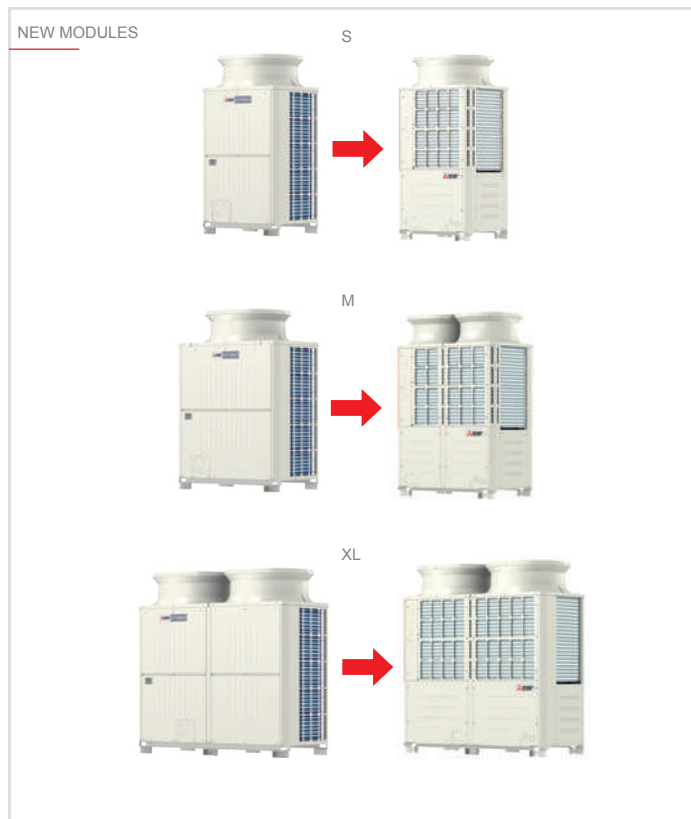
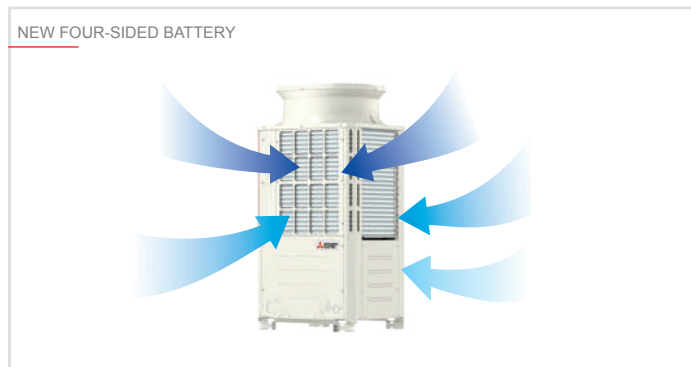

Single module

		Previous model	YNW
8HP	P200	S	S
10HP	P250	S	S
12HP	P300	L	S
14HP	P350	L	L
16HP	P400	L	L
18HP	P450	XL	L
20HP	P500	XL	XL

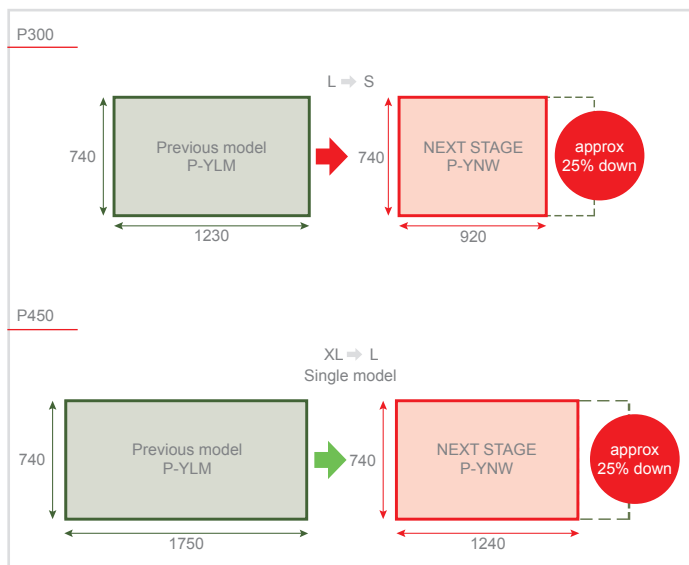

Energy saving

Energy efficiency has been further improved compared to YLM units and now hits top of the range performance values. SEER values have been raised by 139% (P500) compared to the previous model and SCOP values by 49% (P300 and P500). This allows the new YNW units to consume less energy in both cooling and heating. All year-round saving.



Advanced “Low Noise” function

“Low noise” mode can now be selected from five different settings: 85%, 70%, 60% and 50% (values referring to fan speed). Noise reduction is directly configurable from the control board of the outdoor unit. Different settings can be selected based on the installation requirements (in applications with special noise constraints).

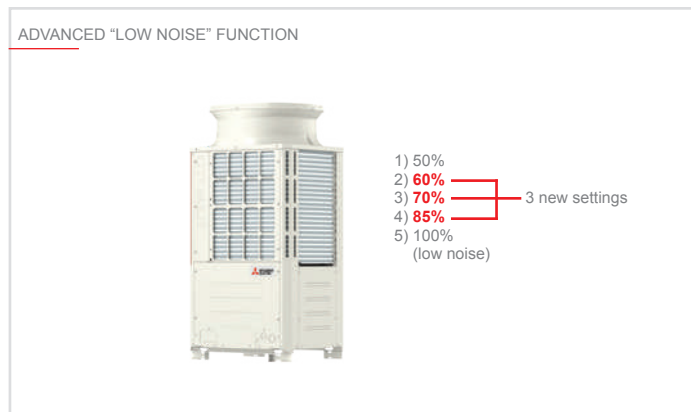

Fan blade profile

The YNW series fan has been completely redesigned to match the new four-sided battery. The profile of the fins has been optimised to minimise fluid flow losses.

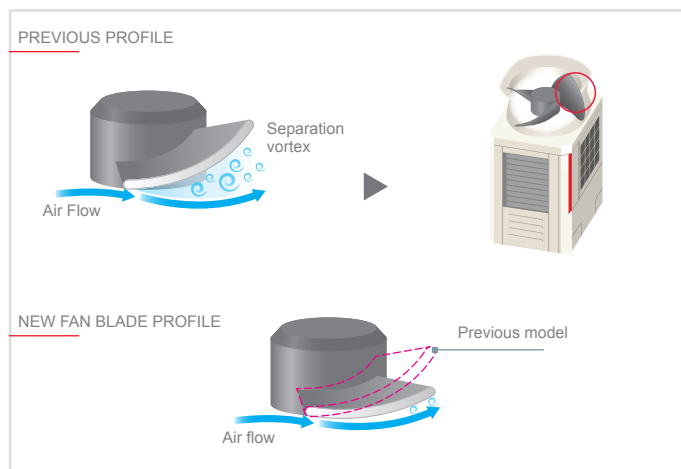

Key Technologies

Technical specifications

MODEL			PUHY-P200YNW-A2(-BS)	PUHY-P250YNW-A2(-BS)	PUHY-P300YNW-A2(-BS)	PUHY-P350YNW-A2(-BS)	PUHY-P400YNW-A2(-BS)
HP			8	10	12	14	16
Modules			PUHY-P200YNW-A2	PUHY-P250YNW-A2	PUHY-P300YNW-A2	PUHY-P350YNW-A2	PUHY-P400YNW-A2
Power supply	V/Hz/n°		3-phase 4-wire 380-400-415 V 50/60 Hz				
Cooling	Capacity (nominal) *1	kW	22.4	28.0	33.5	40.0	45.0
	Power input (nominal)	kW	6.03	9.62	11.31	13.98	17.57
	SEER		7.65	6.90	6.70	6.35	5.85
	Temperature operating field	Indoor WB °C	15.0~24.0°C	15.0~24.0°C	15.0~24.0°C	15.0~24.0°C	15.0~24.0°C
	Outdoor DB °C	-5.0~52.0°C	-5.0~52.0°C	-5.0~52.0°C	-5.0~52.0°C	-5.0~52.0°C	
Heating	Capacity (nominal) *2/ Capacity (max) *2	kW	22.4/25.0	28.0/31.5	33.5/37.5	40.0/45.0	45.0/50.0
	Power input (nominal)/ Power input (max)	kW	5.18/6.08	7.01/8.49	8.74/10.30	10.20/12.32	12.00/14.20
	SCOP		4.35	4.39	4.12	4.33	4.00
	Temperature operating field	Indoor DB °C	15.0~27.0°C	15.0~27.0°C	15.0~27.0°C	15.0~27.0°C	15.0~27.0°C
	Outdoor WB °C	-20.0~15.5°C	-20.0~15.5°C	-20.0~15.5°C	-20.0~15.5°C	-20.0~15.5°C	
Sound level*4,5	Sound pressure (Sound power) level	dB(A)	58/59 (75/77)	60/61 (78/80)	61/64.5 (80/84)	62/64.5 (80/84)	65/67 (82/86)
Connectable indoor units	Total Capacity		50~130% of outdoor unit capacity				
	Model/Quantity	CITY MULTI	P10~P250, M20~M140/1~20	P10~P250, M20~M140/1~25	P10~P250, M20~M140/1~30	P10~P250, M20~M140/1~35	P10~P250, M20~M140/1~40
Ø Ref. piping diameter	Liquid	mm	9.52	9.52	9.52	12.7	12.7
	Gas	mm	22.2	22.2	22.2	28.58	28.58
Fan*6	Type x quantity		Propeller fan x 1	Propeller fan x 1	Propeller fan x 1	Propeller fan x 2	Propeller fan x 2
	Air flow	m³/min	170	185	240	270	300
Compressor	Type		Inverter scroll hermetic				
	Motor output	kW	3.5	5.3	6.7	8.6	11.4
External dimensions	H(H*)xWxD	mm	1858(1798)x920x740	1858(1798)x920x740	1858(1798)x920x740	1858(1798)x1240x740	1858(1798)x1240x740
Net weight		kg	213	213	226	277	277
Refrigerant	Ref. Charge R410	kg	6.5	6.5	6.5	9.8	9.8
	CO ₂ eq.	Tons	13.57	13.57	13.57	20.46	20.46

*1,*2,*3 Nominal conditions (subject to JIS B8615-2)

	Indoor	Outdoor	Pipe length	Level difference
Cooling	27°C DB/19°C WB	35°C DB	7.5m	0m
Heating	20°C DB	7°C DB/6°C WB	7.5m	0m

*3 Eurovent registered

*4 Cooling mode / Heating mode

*5 The sound pressure level measured by the conventional method in JIS for reference purpose.

*6 External static pressure option is available (30 Pa, 60 Pa, 80 Pa/3.1 mmH₂O, 6.1 mmH₂O, 8.2 mmH₂O).

Consult your dealer about the specification when setting External static pressure option.

*Due to continuing improvement, above specifications may be subject to change without notice.

Technical specifications

MODEL			PUHY-P450YNW-A2(-BS)	PUHY-P500YNW-A2(-BS)	PUHY-P400YSNW-A2(-BS)	PUHY-P450YSNW-A2(-BS)	PUHY-P500YSNW-A2(-BS)
HP			16	20	16	16	20
Modules			PUHY-P450YNW-A2	PUHY-P500YNW-A2	PUHY-P(200+200)YNW-A2	PUHY-P(200+250)YNW-A2	PUHY-P(250+250)YNW-A2
Power supply	V/Hz/n°	3-phase 4-wire 380-400-415 V 50/60 Hz					
Cooling	Capacity (nominal) *1	kW	50,0	56,0	44,8	50,4	56,0
	Power input (nominal)	kW	18,86	21,05	12,47	15,94	19,85
	SEER		6,48	6,32	7,42	7,03	6,69
	Temperature operating field	Indoor WB	°C	15.0~24.0°C	15.0~24.0°C	15.0~24.0°C	15.0~24.0°C
Outdoor DB		°C	-5.0~52.0°C	-5.0~52.0°C	-5.0~52.0°C	-5.0~52.0°C	-5.0~52.0°C
Heating	Capacity (nominal) *3/ Capacity (max) *2	kW	50,0/56,0	56,0/63,0	44,8/50,0	50,4/56,5	56,0/63,0
	Power input (nominal)/ Power input (max)	kW	13,77/16,51	14,85/17,89	10,37/12,16	12,20/14,56	14,03/16,98
	SCOP		4,31	4,04	4,35	4,37	4,39
	Temperature operating field	Indoor DB	°C	15.0~27.0°C	15.0~27.0°C	15.0~27.0°C	15.0~27.0°C
Outdoor WB		°C	-20.0~15.5°C	-20.0~15.5°C	-20.0~15.5°C	-20.0~15.5°C	-20.0~15.5°C
Sound level**4,5	Sound pression (Sound power) level	dB(A)	65,5/71,0 (84/90)	63,5/66,5 (82/85)	61/62 (78/80)	62/63 (80/82)	63/64 (81/83)
Connectable indoor units	Total Capacity	50~130% of outdoor unit capacity					
	Model/Quantity	CITY MULTI	P10~P250, M20~M140/1~45	P10~P250, M20~M140/1~50	P10~P250, M20~M140/1~40	P10~P250, M20~M140/1~45	P10~P250, M20~M140/1~50
Ø Ref. piping diameter	Liquid	mm	15,88	15,88	12,7	15,88	15,88
	Gas	mm	28,58	28,58	28,58	28,58	28,58
Fan*6	Type x quantity		Propeller fan x 2	Propeller fan x 2	Propeller fan x 2	Propeller fan x 2	Propeller fan x 2
	Air flow	m³/min	305	365	170+170	170+185	185+185
Compressor	Type	Inverter scroll hermetic					
	Motor output	kW	11,7	13,3	3,5+3,5	3,5+5,3	5,3+5,3
External dimentions	H(H*)xWxD	mm	1858(1798)x1240x740	1858(1798)x1750x740	1858(1798)x920x740 1858(1798)x920x740	1858(1798)x920x740 1858(1798)x920x740	1858(1798)x920x740 1858(1798)x920x740
Net weight		kg	293	334	213+213	213+213	213+213
Refrigerant	Ref. Charge R410	kg	10,8	10,8	13	13	13
	CO ₂ eq.	Tons	22,55	22,55	27,14	27,14	27,14

Technical specifications

MODEL			PUHY-P550YSNW-A2(-BS)	PUHY-P600YSNW-A2(-BS)	PUHY-P650YSNW-A2(-BS)	PUHY-P700YSNW-A2(-BS)	PUHY-P750YSNW-A2(-BS)
HP			22	24	26	28	30
Modules			PUHY-P(250+300)YNW-A2	PUHY-P(300+300)YNW-A2	PUHY-P(250+400)YNW-A2	PUHY-P(350+350)YNW-A2	PUHY-P(350+400)YNW-A2
Power supply	V/Hz/n°	3-phase 4-wire 380-400-415 V 50/60 Hz					
Cooling	Capacity (nominal) *1	kW	61,5	67,0	73,0	80,0	85,0
	Power input (nominal)	kW	21,65	23,34	27,96	28,88	32,56
	SEER		6,59	6,50	6,08	6,15	5,90
	Temperature operating field	Indoor WB	°C	15.0~24.0°C	15.0~24.0°C	15.0~24.0°C	15.0~24.0°C
Outdoor DB		°C	-5.0~52.0°C	-5.0~52.0°C	-5.0~52.0°C	-5.0~52.0°C	-5.0~52.0°C
Heating	Capacity (nominal) *3/ Capacity (max) *2	kW	61,5/69,0	67,0/75,0	73,0/81,5	80,0/90,0	85,0/95,0
	Power input (nominal)/ Power input (max)	kW	15,76/18,80	17,49/20,60	19,01/22,70	20,40/24,65	22,25/26,53
	SCOP		4,24	4,12	4,14	4,33	4,14
	Temperature operating field	Indoor DB	°C	15.0~27.0°C	15.0~27.0°C	15.0~27.0°C	15.0~27.0°C
Outdoor WB		°C	-20.0~15.5°C	-20.0~15.5°C	-20.0~15.5°C	-20.0~15.5°C	-20.0~15.5°C
Sound level**4,5	Sound pression (Sound power) level	dB(A)	63,5/66 (82/85)	64/67,5 (83/87)	66,5/68 (83/87)	65/67,5 (83/87)	67/69 (84/88)
Connectable indoor units	Total Capacity	50~130% of outdoor unit capacity					
	Model/Quantity	CITY MULTI	P10~P250, M20~M140/2~50	P10~P250, M20~M140/2~50	P10~P250, M20~M140/2~50	P10~P250, M20~M140/2~50	P10~P250, M20~M140/2~50
Ø Ref. piping diameter	Liquid	mm	15,88	15,88	15,88	19,05	19,05
	Gas	mm	28,58	28,58	28,58	34,93	34,93
Fan*6	Type x quantity		Propeller fan x 2	Propeller fan x 2	Propeller fan x 3	Propeller fan x 4	Propeller fan x 4
	Air flow	m³/min	185+240	240+240	185+300	270+270	270+300
Compressor	Type	Inverter scroll hermetic					
	Motor output	kW	5,3+6,7	6,7 + 6,7	5,3 + 11,4	8,6+8,6	8,6+11,4
External dimentions	H(H*)xWxD	mm	1858(1798)x920x740 1858(1798)x920x740	1858(1798)x920x740 1858(1798)x920x740	1858(1798)x920x740 1858(1798)x1240x740	1858(1798)x1240x740 1858(1798)x1240x740	1858(1798)x1240x740 1858(1798)x1240x740
Net weight		kg	213+226	226+226	213+277	277+277	277+277
Refrigerant	Ref. Charge R410	kg	13	13	16,3	19,6	19,6
	CO ₂ eq.	Tons	27,14	27,14	34,03	40,92	40,92

*1,*2,*3 Nominal conditions (subject to JIS B8615-2)

	Indoor	Outdoor	Pipe length	Level difference
Cooling	27°C DB/19°C WB	35°C DB	7.5m	0m
Heating	20°C DB	7°C DB/6°C WB	7.5m	0m

*3 Eurovent registered

*4 Cooling mode / Heating mode

*5 The sound pressure level measured by the conventional method in JIS for reference purpose.

*6 External static pressure option is available (30 Pa, 60 Pa, 80 Pa/3.1 mmH₂O, 6.1 mmH₂O, 8.2 mmH₂O).

Consult your dealer about the specification when setting External static pressure option.

*Due to continuing improvement, above specifications may be subject to change without notice.

Technical specifications

MODEL			PUHY-P800YSNW-A2(-BS)	PUHY-P850YSNW-A2(-BS)	PUHY-P900YSNW-A2(-BS)	PUHY-P950YSNW-A2(-BS)	PUHY-P1000YSNW-A2(-BS)
HP			32	34	36	38	40
Modules			PUHY-P(350+450)YNW-A2	PUHY-P(400+450)YNW-A2	PUHY-P(450+450)YNW-A2	PUHY-P(250+350+350)YNW-A2	PUHY-P(250+350+400)YNW-A2
Power supply	V/Hz/n ³	3-phase 4-wire 380-400-415 V 50/60 Hz					
Cooling	Capacity (nominal) ^{*1}	kW	90	95,0	100,0	108,0	113,0
	Power input (nominal)	kW	33,96	37,69	38,91	38,84	42,48
	SEER		6,22	5,99	6,28	6,30	6,10
	Temperature operating field	Indoor WB	°C	15.0~24.0°C	15.0~24.0°C	15.0~24.0°C	15.0~24.0°C
Outdoor DB		°C	-5.0~52.0°C	-5.0~52.0°C	-5.0~52.0°C	-5.0~52.0°C	-5.0~52.0°C
Heating	Capacity (nominal) ^{*2} / Capacity (max) ^{*2}	kW	90,0/101,0	95,0/106,0	100,0/112,0	108,0/121,5	113,0/126,5
	Power input (nominal)/ Power input (max)	kW	24,00/28,85	25,81/30,72	27,54/33,03	27,48/33,19	29,27/35,04
	SCOP		4,32	4,16	4,32	4,34	4,21
	Temperature operating field	Indoor DB	°C	15.0~27.0°C	15.0~27.0°C	15.0~27.0°C	15.0~27.0°C
Outdoor WB		°C	-20.0~15.5°C	-20.0~15.5°C	-20.0~15.5°C	-20.0~15.5°C	-20.0~15.5°C
Sound level ^{*4,5}	Sound pression (Sound power) level	dB(A)	67,5/71 (85/91)	68,5/73 (86/91)	68,5/74 (87/93)	66,5/68,5 (84/88)	68/70 (85/89)
Connectable indoor units	Total Capacity	50~130% of outdoor unit capacity					
	Model/Quantity	CITY MULTI	P10~P250, M20~M140/2~50	P10~P250, M20~M140/2~50	P10~P250, M20~M140/2~50	P10~P250, M20~M140/2~50	P10~P250, M20~M140/2~50
Ø Ref. piping diameter	Liquid	mm	19,05	19,05	19,05	19,05	19,05
	Gas	mm	34,93	41,28	41,28	41,28	41,28
Fan ⁶	Type x quantity		Propeller fan x 4	Propeller fan x 4	Propeller fan x 4	Propeller fan x 5	Propeller fan x 5
	Air flow	m ³ /min	270+305	300+305	305+305	185+270+270	185+270+300
Compressor	Type	Inverter scroll hermetic					
	Motor output	kW	8,6+11,7	11,4+11,7	11,7+11,7	5,3+8,6+8,6	5,3+8,6+11,4
External dimention	H(H ⁵)xWxD	mm	1858(1798)x1240x740 1858(1798)x1240x740	1858(1798)x1240x740 1858(1798)x1240x740	1858(1798)x1240x740 1858(1798)x1240x740	1858(1798)x920x740 1858(1798)x1240x740 1858(1798)x1240x740	1858(1798)x920x740 1858(1798)x1240x740 1858(1798)x1240x740
Net weight		kg	277+293	277+293	293+293	213+277+277	213+277+277
Refrigerant	Ref. Charge R410	kg	20,6	20,6	21,6	26,1	26,1
	CO ₂ eq.	Tons	43,01	43,01	45,10	54,49	54,49

Technical specifications

MODEL			PUHY-P1050YSNW-A2(-BS)	PUHY-P1100YSNW-A2(-BS)	PUHY-P1150YSNW-A2(-BS)	PUHY-P1200YSNW-A2(-BS)	PUHY-P1250YSNW-A2(-BS)
HP			42	44	46	48	50
Modules			PUHY-P(250+400+400)YNW-A2	PUHY-P(350+350+400)YNW-A2	PUHY-P(350+400+400)YNW-A2	PUHY-P(400+400+400)YNW-A2	PUHY-P(400+400+450)YNW-A2
Power supply	V/Hz/n ³	3-phase 4-wire 380-400-415 V 50/60 Hz					
Cooling	Capacity (nominal) ^{*1}	kW	118,0	125,0	130,0	135,0	140,0
	Power input (nominal)	kW	46,09	46,99	50,58	54,43	55,77
	SEER		5,93	5,98	5,82	5,66	5,89
	Temperature operating field	Indoor WB	°C	15.0~24.0°C	15.0~24.0°C	15.0~24.0°C	15.0~24.0°C
Outdoor DB		°C	-5.0~52.0°C	-5.0~52.0°C	-5.0~52.0°C	-5.0~52.0°C	-5.0~52.0°C
Heating	Capacity (nominal) ^{*1} / Capacity (max) ^{*2}	kW	118,0/131,5	125,0/140,0	130,0/145,0	135,0/150,0	140,0/156,0
	Power input (nominal)/ Power input (max)	kW	31,05/36,93	32,46/38,88	34,21/40,84	36,00/42,61	37,83/44,95
	SCOP		4,09	4,20	4,09	4,00	4,11
	Temperature operating field	Indoor DB	°C	15.0~27.0°C	15.0~27.0°C	15.0~27.0°C	15.0~27.0°C
Outdoor WB		°C	-20.0~15.5°C	-20.0~15.5°C	-20.0~15.5°C	-20.0~15.5°C	-20.0~15.5°C
Sound level ^{*4,5}	Sound pression (Sound power) level	dB(A)	69,0/70,5 (86/90)	68,5/70,5 (86/90)	69,5/71,5 (86/90)	70/72 (87/91)	70/74 (88/93)
Connectable indoor units	Total Capacity	50~130% of outdoor unit capacity					
	Model/Quantity	CITY MULTI	P10~P250, M20~M140/3~50	P10~P250, M20~M140/3~50	P10~P250, M20~M140/3~50	P10~P250, M20~M140/3~50	P10~P250, M20~M140/3~50
Ø Ref. piping diameter	Liquid	mm	19,05	19,05	19,05	19,05	19,05
	Gas	mm	41,28	41,28	41,28	41,28	41,28
Fan ⁶	Type x quantity		Propeller fan x 5	Propeller fan x 6	Propeller fan x 6	Propeller fan x 6	Propeller fan x 6
	Air flow	m ³ /min	185+300+300	270+270+300	270+300+300	300+300+300	300+300+305
Compressor	Type	Inverter scroll hermetic					
	Motor output	kW	5,3+11,4+11,4	8,6+8,6+11,4	8,6+11,4+11,4	11,4+11,4+11,4	11,4+11,4+11,7
External dimention	H(H ⁵)xWxD	mm	1858(1798)x920x740 1858(1798)x1240x740 1858(1798)x1240x740	1858(1798)x1240x740 1858(1798)x1240x740 1858(1798)x1240x740	1858(1798)x1240x740 1858(1798)x1240x740 1858(1798)x1240x740	1858(1798)x1240x740 1858(1798)x1240x740 1858(1798)x1240x740	1858(1798)x1240x740 1858(1798)x1240x740 1858(1798)x1240x740
Net weight		kg	213+277+277	277+277+277	277+277+277	277+277+277	277+277+293
Refrigerant	Ref. Charge R410	kg	26,1	29,4	29,4	29,4	30,4
	CO ₂ eq.	Tons	54,49	61,38	61,38	61,38	63,47

^{1,2,3} Nominal conditions (subject to JIS B8615-2)

	Indoor	Outdoor	Pipe length	Level difference
Cooling	27°C DB/19°C WB	35°C DB	7.5m	0m
Heating	20°C DB	7°C DB/6°C WB	7.5m	0m

³ Eurovent registered

⁴ Cooling mode / Heating mode

⁵ The sound pressure level measured by the conventional method in JIS for reference purpose.

⁶ External static pressure option is available (30 Pa, 60 Pa, 80 Pa/3.1 mmH₂O, 6.1 mmH₂O, 8.2 mmH₂O).

Consult your dealer about the specification when setting External static pressure option.

*Due to continuing improvement, above specifications may be subject to change without notice.

Technical specifications					
MODEL		PUHY-P1300YSNW-A2(-BS)		PUHY-P1300YSNW-A2(-BS)	
HP		52		54	
Modules		PUHY-P (400+450+450)YNW-A2		PUHY-P (450+450+450)YNW-A2	
Power supply	V/Hz/n°	3-phase 4-wire 380-400-415 V 50/60 Hz			
Cooling	Capacity (nominal) *1	kW		145,0	
	Power input (nominal)	kW		57,08	
	SEER			6,09	
	Temperature operating field	Indoor WB	°C	15.0~24.0°C	
		Outdoor DB	°C	-5.0~52.0°C	
Heating	Capacity (nominal) *3/ Capacity (max) *2	kW		145,0/162,0	
	Power input (nominal)/ Power input (max)	kW		39,61/47,23	
	SCOP			4,21	
	Temperature operating field	Indoor DB	°C	15.0~27.0°C	
			Outdoor WB	°C	-20.0~15.5°C
Sound level**4,5	Sound pression (Sound power) level	dB(A)		70,75 (88/94)	
Connectable indoor units	Total Capacity	50~130% of outdoor unit capacity			
	Model/Quantity	CITY MULTI	P10~P250, M20~M140/3~50		P10~P250, M20~M140/3~50
Ø Ref. piping diameter	Liquid	mm		19,05	
	Gas	mm		41,28	
Fan*6	Type x quantity			Propeller fan x 6	
	Air flow	m³/min		300+305+305	
Compressor	Type	Inverter scroll hermetic			
	Motor output	kW		11,4+11,7+11,7	
External dimentions	H(H*5)xWxD	mm		1858(1798)x1240x740	
				1858(1798)x1240x740	
Net weight		kg		277+293+293	
Refrigerant	Ref. Charge R410	kg		31,4	
	CO ₂ eq.	Tons		65,56	

Technical specifications											
MODEL		PUHY-EP200YNW-A2 (-BS)		PUHY-EP250YNW-A2 (-BS)		PUHY-EP300YNW-A2 (-BS)		PUHY-EP350YNW-A2 (-BS)		PUHY-EP400YNW-A2 (-BS)	
HP		8		10		12		14		16	
Modules		PUHY-EP200YNW-A2		PUHY-EP250YNW-A2		PUHY-EP300YNW-A2		PUHY-EP350YNW-A2		PUHY-EP400YNW-A2	
Power supply	V/Hz/n°	3-phase 4-wire 380-400-415 V 50/60 Hz									
Cooling	Capacity (nominal) *1	kW		22,4		28,0		33,5		40,0	
	Power input (nominal)	kW		5,51		8,21		9,68		12,42	
	SEER			7,76		7,51		7,26		7,03	
	Temperature operating field	Indoor WB	°C	15.0~24.0°C		15.0~24.0°C		15.0~24.0°C		15.0~24.0°C	
		Outdoor DB	°C	-5.0~52.0°C		-5.0~52.0°C		-5.0~52.0°C		-5.0~52.0°C	
Heating	Capacity (nominal) *3/ Capacity (max) *2	kW		22,4 / 25,0		28,0 / 31,5		33,5 / 37,5		40,0 / 45,0	
	Power input (nominal)/ Power input (max)	kW		5,01 / 5,93		6,84 / 8,13		8,27 / 9,84		9,77 / 11,81	
	SCOP			4,36		4,40		4,12		4,35	
	Temperature operating field	Indoor DB	°C	15.0~27.0°C		15.0~27.0°C		15.0~27.0°C		15.0~27.0°C	
			Outdoor WB	°C	-20.0~15.5°C		-20.0~15.5°C		-20.0~15.5°C		-20.0~15.5°C
Sound level**4,5	Sound pression (Sound power) level	dB(A)		58,0/59,0 (75/78)		60,0/61,0 (78/80)		61,0/64,5 (80/84)		62,0/64,0 (80/83)	
Connectable indoor units	Total Capacity	50~130% of outdoor unit capacity									
	Model/Quantity	CITY MULTI	P10~P250, M20~M140/1~20		P10~P250, M20~M140/1~25		P10~P250, M20~M140/1~30		P10~P250, M20~M140/1~35		P10~P250, M20~M140/1~40
Ø Ref. piping diameter	Liquid	mm		9,52		9,52		9,52		12,7	
	Gas	mm		22,2		22,2		28,58		28,58	
Fan*6	Type x quantity			Propeller fan x 1		Propeller fan x 1		Propeller fan x 1		Propeller fan x 2	
	Air flow	m³/min		170		185		240		270	
Compressor	Type	Inverter scroll hermetic compressor									
	Motor output	kW		3,4		5,1		6,1		7,7	
External dimentions	H(H*5)xWxD	mm		1858(1798)x920x740		1858(1798)x920x740		1858(1798)x920x740		1858(1798)x1240x740	
Net weight		kg		228		228		231		282	
Refrigerant	Ref. Charge R410	kg		6,5		6,5		6,5		9,8	
	CO ₂ eq.	Tons		13,57		13,57		13,57		20,46	

*1,*2,*3 Nominal conditions (subject to JIS B8615-2)

	Indoor	Outdoor	Pipe length	Level difference
Cooling	27°C DB/19°C WB	35°C DB	7.5m	0m
Heating	20°C DB	7°C DB/6°C WB	7.5m	0m

*3 Eurovent registered

*4 Cooling mode / Heating mode

*5 The sound pressure level measured by the conventional method in JIS for reference purpose.

*6 External static pressure option is available (30 Pa, 60 Pa, 80 Pa/3.1 mmH₂O, 6.1 mmH₂O, 8.2 mmH₂O).

Consult your dealer about the specification when setting External static pressure option.

*Due to continuing improvement, above specifications may be subject to change without notice.

Technical specifications

MODEL			PUHY-EP450YNW-A2 (-BS)	PUHY-EP500YNW-A2 (-BS)	PUHY-EP400YSNW-A2 (-BS)	PUHY-EP450YSNW-A2 (-BS)	PUHY-EP500YSNW-A2 (-BS)
HP			18	20	16	18	20
Modules			PUHY-EP450YNW-A2	PUHY-EP500YNW-A2	PUHY-EP(200+200)YNW-A2	PUHY-EP(200+250)YNW-A2	PUHY-EP(250+250)YNW-A2
Power supply	V/Hz/n [°]	3-phase 4-wire 380-400-415 V 50/60 Hz					
Cooling	Capacity (nominal) ^{*1}	kW	50.0	56.0	44.8	50.4	56.0
	Power input (nominal)	kW	17.73	20.51	11.39	14.07	16.96
	SEER		6.94	6.55	7.53	7.40	7.29
	Temperature operating field	Indoor WB	°C	15.0~24.0°C	15.0~24.0°C	15.0~24.0°C	15.0~24.0°C
Outdoor DB		°C	-5.0~52.0°C	-5.0~52.0°C	-5.0~52.0°C	-5.0~52.0°C	-5.0~52.0°C
Heating	Capacity (nominal) ^{*2} / Capacity (max) ^{*2}	kW	50.0 / 56.0	56.0 / 63.0	44.8 / 50.0	50.4 / 56.5	56.0 / 63.0
	Power input (nominal)/ Power input (max)	kW	12.85 / 16.18	14.73 / 17.74	10.02 / 11.87	11.85 / 14.05	13.69 / 16.27
	SCOP		4.32	4.10	4.36	4.37	4.40
	Temperature operating field	Indoor DB	°C	15.0~27.0°C	15.0~27.0°C	15.0~27.0°C	15.0~27.0°C
Outdoor WB		°C	-20.0~15.5°C	-20.0~15.5°C	-20.0~15.5°C	-20.0~15.5°C	-20.0~15.5°C
Sound level ^{*4,5}	Sound pression (Sound power) level	dB(A)	65.5/70.5 (84/90)	63.5/66.5 (82/85)	61.0/62.0 (78/81)	62.5/63.5 (80/82)	63.5/64.0 (81/83)
Connectable indoor units	Total Capacity	50~130% of outdoor unit capacity					
	Model/Quantity	CITY MULTI	P10~P250, M20~M140/1~45	P10~P250, M20~M140/1~50	P10~P250, M20~M140/1~40	P10~P250, M20~M140/1~45	P10~P250, M20~M140/1~50
Ø Ref. piping diameter	Liquid	mm	15.88	15.88	12.7	15.88	15.88
	Gas	mm	28.58	28.58	28.58	28.58	28.58
Fan ⁶	Type x quantity		Propeller fan x 2	Propeller fan x 2	Propeller fan x 2	Propeller fan x 2	Propeller fan x 2
	Air flow	m ³ /min	305	365	170 + 170	170 + 185	185 + 185
Compressor	Type	Inverter scroll hermetic compressor					
	Motor output	kW	11.1	12.5	3.4 + 3.4	3.4 + 5.1	5.1 + 5.1
External dimentions	H(H ⁵)xWxD	mm	1858(1798)x1240x740	1858(1798)x1750x740	1858(1798)x920x740 1858(1798)x920x740	1858(1798)x920x740 1858(1798)x920x740	1858(1798)x920x740 1858(1798)x920x740
Net weight		kg	303	342	228 + 228	228 + 228	228 + 228
Refrigerant	Ref. Charge R410	kg	10.8	10.8	13	13	13
	CO ₂ eq.	Tons	22.55	22.55	27.14	27.14	27.14

Technical specifications

MODEL			PUHY-EP550YSNW-A2 (-BS)	PUHY-EP600YSNW-A2 (-BS)	PUHY-EP650YSNW-A2 (-BS)	PUHY-EP700YSNW-A2 (-BS)	PUHY-EP750YSNW-A2 (-BS)
HP			22	24	26	28	30
Modules			PUHY-EP(250+300)YNW-A2	PUHY-EP(300+300)YNW-A2	PUHY-EP(250+400)YNW-A2	PUHY-EP(350+350)YNW-A2	PUHY-EP(350+400)YNW-A2
Power supply	V/Hz/n [°]	3-phase 4-wire 380-400-415 V 50/60 Hz					
Cooling	Capacity (nominal) ^{*1}	kW	61.5	67.0	73.0	80.0	85.0
	Power input (nominal)	kW	18.46	20.00	23.54	25.64	27.96
	SEER		7.16	7.04	6.89	6.82	6.72
	Temperature operating field	Indoor WB	°C	15.0~24.0°C	15.0~24.0°C	15.0~24.0°C	15.0~24.0°C
Outdoor DB		°C	-5.0~52.0°C	-5.0~52.0°C	-5.0~52.0°C	-5.0~52.0°C	-5.0~52.0°C
Heating	Capacity (nominal) ^{*2} / Capacity (max) ^{*2}	kW	61.5 / 69.0	67.0 / 75.0	73.0 / 81.5	80.0 / 90.0	85.0 / 95.0
	Power input (nominal)/ Power input (max)	kW	15.14 / 18.01	16.54 / 19.68	18.52 / 21.96	19.55 / 23.62	21.46 / 25.67
	SCOP		4.24	4.12	4.30	4.35	4.29
	Temperature operating field	Indoor DB	°C	15.0~27.0°C	15.0~27.0°C	15.0~27.0°C	15.0~27.0°C
Outdoor WB		°C	-20.0~15.5°C	-20.0~15.5°C	-20.0~15.5°C	-20.0~15.5°C	-20.0~15.5°C
Sound level ^{*4,5}	Sound pression (Sound power) level	dB(A)	64.0/66.5 (82/85)	64.0/67.5 (83/87)	66.5/67.0 (83/86)	65.0/67.0 (83/86)	67.0/68.0 (84/87)
Connectable indoor units	Total Capacity	50~130% of outdoor unit capacity					
	Model/Quantity	CITY MULTI	P10~P250, M20~M140/2~50	P10~P250, M20~M140/2~50	P10~P250, M20~M140/2~50	P10~P250, M20~M140/2~50	P10~P250, M20~M140/2~50
Ø Ref. piping diameter	Liquid	mm	15.88	15.88	15.88	19.05	19.05
	Gas	mm	28.58	28.58	28.58	34.93	34.93
Fan ⁶	Type x quantity		Propeller fan x 2	Propeller fan x 2	Propeller fan x 3	Propeller fan x 4	Propeller fan x 4
	Air flow	m ³ /min	185 + 240	240 + 240	185 + 270	270 + 270	270 + 270
Compressor	Type	Inverter scroll hermetic compressor					
	Motor output	kW	5.1 + 6.1	6.1 + 6.1	5.1 + 9.8	7.7 + 7.7	7.7 + 9.8
External dimentions	H(H ⁵)xWxD	mm	1858(1798)x920x740 1858(1798)x920x740	1858(1798)x920x740 1858(1798)x920x740	1858(1798)x920x740 1858(1798)x1240x740	1858(1798)x1240x740 1858(1798)x1240x740	1858(1798)x1240x740 1858(1798)x1240x740
Net weight		kg	228 + 231	231 + 231	228 + 303	282 + 282	282 + 303
Refrigerant	Ref. Charge R410	kg	13	13	17.3	19.6	20.6
	CO ₂ eq.	Tons	27.14	27.14	36.12	40.92	43.01

^{*1,2,3} Nominal conditions (subject to JIS B8615-2)

	Indoor	Outdoor	Pipe length	Level difference
Cooling	27°C DB/19°C WB	35°C DB	7.5m	0m (0ft.)
Heating	20°C DB	7°C DB/6°C WB	7.5m	0m (0ft.)

³ Eurovent registered

⁴ Cooling mode / Heating mode

⁵ The sound pressure level measured by the conventional method in JIS for reference purpose.

⁶ External static pressure option is available (30 Pa, 60 Pa, 80 Pa/3.1 mmH₂O, 6.1 mmH₂O, 8.2 mmH₂O). Consult your dealer about the specification when setting External static pressure option.

*Due to continuing improvement, above specifications may be subject to change without notice.

Technical specifications

MODEL			PUHY-EP800YSNW-A2 (BS)	PUHY-EP850YSNW-A2 (BS)	PUHY-EP900YSNW-A2 (BS)	PUHY-EP950YSNW-A2 (BS)	PUHY-EP1000YSNW-A2 (BS)
HP			32	34	36	38	40
Modules			PUHY-EP(350+450)YNW-A2	PUHY-EP(400+450)YNW-A2	PUHY-EP(450+450)YNW-A2	PUHY-EP(250+350+350)YNW-A2	PUHY-EP(250+350+400)YNW-A2
Power supply	V/Hz/n ³		3-phase 4-wire 380-400-415 V 50/60 Hz				
Cooling	Capacity (nominal) ^{*1}	kW	90.0	95.0	100.0	108.0	113.0
	Power input (nominal)	kW	31.03	33.45	36.63	34.06	36.33
	SEER		6.77	6.68	6.73	6.95	6.87
	Temperature operating field	Indoor WB	°C	15.0~24.0°C	15.0~24.0°C	15.0~24.0°C	15.0~24.0°C
Outdoor DB		°C	-5.0~52.0°C	-5.0~52.0°C	-5.0~52.0°C	-5.0~52.0°C	-5.0~52.0°C
Heating	Capacity (nominal) ^{*3} / Capacity (max) ^{*2}	kW	90.0 / 101.0	95.0 / 106.0	100.0 / 112.0	108.0 / 121.5	113.0 / 126.5
	Power input (nominal)/ Power input (max)	kW	22.67 / 27.97	24.54 / 30.02	25.70 / 32.36	26.40 / 31.80	28.32 / 33.82
	SCOP		4.33	4.28	4.32	4.36	4.32
	Temperature operating field	Indoor DB	°C	15.0~27.0°C	15.0~27.0°C	15.0~27.0°C	15.0~27.0°C
Outdoor WB		°C	-20.0~15.5°C	-20.0~15.5°C	-20.0~15.5°C	-20.0~15.5°C	-20.0~15.5°C
Sound level ^{**4,5}	Sound pressure (Sound power) level	dB(A)	67.5/70.5 (85/91)	68.5/72.0 (86/91)	69.0/73.5 (87/93)	66.5/68.0 (84/87)	68.0/68.5 (85/88)
Connectable indoor units	Total Capacity	50~130% of outdoor unit capacity					
	Model/Quantity	CITY MULTI	P10~P250, M20~M140/2~50	P10~P250, M20~M140/2~50	P10~P250, M20~M140/2~50	P10~P250, M20~M140/2~50	P10~P250, M20~M140/2~50
Ø Ref. piping diameter	Liquid	mm	19.05	19.05	19.05	19.05	19.05
	Gas	mm	34.93	41.28	41.28	41.28	41.28
Fan ⁶	Type x quantity		Propeller fan x 4	Propeller fan x 4	Propeller fan x 4	Propeller fan x 5	Propeller fan x 5
	Air flow	m ³ /min	270 + 305	270 + 305	305 + 305	185 + 270 + 270	185 + 270 + 270
Compressor	Type	Inverter scroll hermetic compressor					
	Motor output	kW	7.7 + 11.1	9.8 + 11.1	11.1 + 11.1	5.1 + 7.7 + 7.7	5.1 + 7.7 + 9.8
External dimensions	H(H ⁺)xWxD	mm	1858(1798)x1240x740 1858(1798)x1240x740	1858(1798)x1240x740 1858(1798)x1240x740	1858(1798)x1240x740 1858(1798)x1240x740	1858(1798)x920x740 1858(1798)x1240x740 1858(1798)x1240x740	1858(1798)x920x740 1858(1798)x1240x740 1858(1798)x1240x740
Net weight		kg	282 + 303	303 + 303	303 + 303	228 + 282 + 282	228 + 282 + 303
Refrigerant	Ref. Charge R410	kg	20.6	21.6	21.6	26.1	27.1
	CO ₂ eq.	Tons	43.01	45.1	45.1	54.49	56.58

Technical specifications

MODEL			PUHY-EP1050YSNW-A2 (BS)	PUHY-EP1100YSNW-A2 (BS)	PUHY-EP1150YSNW-A2 (BS)	PUHY-EP1200YSNW-A2 (BS)	PUHY-EP1250YSNW-A2 (BS)
HP			42	44	46	48	50
Modules			PUHY-EP(250+400+400)YNW-A2	PUHY-EP(350+350+400)YNW-A2	PUHY-EP(350+400+400)YNW-A2	PUHY-EP(400+400+400)YNW-A2	PUHY-EP(400+400+450)YNW-A2
Power supply	V/Hz/n ³		3-phase 4-wire 380-400-415 V 50/60 Hz				
Cooling	Capacity (nominal) ^{*1}	kW	118.0	125.0	130.0	135.0	140.0
	Power input (nominal)	kW	38.68	40.71	43.04	45.45	48.44
	SEER		6.79	6.75	6.69	6.62	6.66
	Temperature operating field	Indoor WB	°C	15.0~24.0°C	15.0~24.0°C	15.0~24.0°C	15.0~24.0°C
Outdoor DB		°C	-5.0~52.0°C	-5.0~52.0°C	-5.0~52.0°C	-5.0~52.0°C	-5.0~52.0°C
Heating	Capacity (nominal) ^{*3} / Capacity (max) ^{*2}	kW	118.0 / 131.5	125.0 / 140.0	130.0 / 145.0	135.0 / 150.0	140.0 / 156.0
	Power input (nominal)/ Power input (max)	kW	30.17 / 35.83	31.25 / 37.53	33.07 / 39.50	34.97 / 41.55	36.17 / 43.94
	SCOP		4.28	4.31	4.27	4.25	4.27
	Temperature operating field	Indoor DB	°C	15.0~27.0°C	15.0~27.0°C	15.0~27.0°C	15.0~27.0°C
Outdoor WB		°C	-20.0~15.5°C	-20.0~15.5°C	-20.0~15.5°C	-20.0~15.5°C	-20.0~15.5°C
Sound level ^{**4,5}	Sound pressure (Sound power) level	dB(A)	68.5/69.0 (86/89)	68.0/69.5 (86/89)	69.0/70.0 (86/89)	70.0/70.5 (87/90)	70.0/73.0 (88/92)
Connectable indoor units	Total Capacity	50~130% of outdoor unit capacity					
	Model/Quantity	CITY MULTI	P10~P250, M20~M140/3~50	P10~P250, M20~M140/3~50	P10~P250, M20~M140/3~50	P10~P250, M20~M140/3~50	P10~P250, M20~M140/3~50
Ø Ref. piping diameter	Liquid	mm	19.05	19.05	19.05	19.05	19.05
	Gas	mm	41.28	41.28	41.28	41.28	41.28
Fan ⁶	Type x quantity		Propeller fan x 5	Propeller fan x 6	Propeller fan x 6	Propeller fan x 6	Propeller fan x 6
	Air flow	m ³ /min	185 + 270 + 270	270 + 270 + 270	270 + 270 + 270	270 + 270 + 270	270 + 270 + 305
Compressor	Type	Inverter scroll hermetic compressor					
	Motor output	kW	5.1 + 9.8 + 9.8	7.7 + 7.7 + 9.8	7.7 + 9.8 + 9.8	9.8 + 9.8 + 9.8	9.8 + 9.8 + 11.1
External dimensions	H(H ⁺)xWxD	mm	1858(1798)x920x740 1858(1798)x1240x740 1858(1798)x1240x740	1858(1798)x1240x740 1858(1798)x1240x740 1858(1798)x1240x740	1858(1798)x1240x740 1858(1798)x1240x740 1858(1798)x1240x740	1858(1798)x1240x740 1858(1798)x1240x740 1858(1798)x1240x740	1858(1798)x1240x740 1858(1798)x1240x740 1858(1798)x1240x740
Net weight		kg	282 + 303 + 303	282 + 282 + 303	282 + 303 + 303	303 + 303 + 303	303 + 303 + 303
Refrigerant	Ref. Charge R410	kg	28.1	30.4	31.4	32.4	32.4
	CO ₂ eq.	Tons	58.67	63.47	63.47	67.65	67.65

^{*1,2,3} Nominal conditions (subject to JIS B8615-2)

	Indoor	Outdoor	Pipe length	Level difference
Cooling	27°C DB/19°C WB	35°C DB	7.5m	0m (0ft.)
Heating	20°C DB	7°C DB/6°C WB	7.5m	0m (0ft.)

³ Eurovent registered

⁴ Cooling mode / Heating mode

⁵ The sound pressure level measured by the conventional method in JIS for reference purpose.

⁶ External static pressure option is available (30 Pa, 60 Pa, 80 Pa/3.1 mmH₂O, 6.1 mmH₂O, 8.2 mmH₂O).

Consult your dealer about the specification when setting External static pressure option.

*Due to continuing improvement, above specifications may be subject to change without notice.

Technical specifications

MODEL			PUHY-EP1300YSNW-A2 (-BS)	PUHY-EP1350YSNW-A2 (-BS)
HP			52	54
Modules			PUHY-EP(400+450+450)YNW-A2	PUHY-EP(450+450+450)YNW-A2
Power supply	V/Hz/n ³		3-phase 4-wire 380-400-415 V 50/60 Hz	
Cooling	Capacity (nominal) ^{*1}	kW	145.0	150.0
	Power input (nominal)	kW	51,60	54,94
	SEER		6,70	6,73
	Temperature operating field	Indoor WB	°C	15.0~24.0°C
Outdoor DB		°C	-5.0~52.0°C	-5.0~52.0°C
Heating	Capacity (nominal) ^{*2} / Capacity (max) ^{*2}	kW	145.0 / 162.0	150.0 / 168.0
	Power input (nominal)/ Power input (max)	kW	37,37 / 46,28	38,56 / 48,55
	SCOP		4,29	4,32
	Temperature operating field	Indoor DB	°C	15.0~27.0°C
Outdoor WB		°C	-20.0~15.5°C	-20.0~15.5°C
Sound level ^{**4,5}	Sound pressure (Sound power) level	dB(A)	70.0/74.0 (88/94)	70.5/75.5 (89/95)
Connectable indoor units	Total Capacity		50~130% of outdoor unit capacity	
	Model/Quantity	CITY MULTI	P10~P250, M20~M140/3~50	P10~P250, M20~M140/3~50
Ø Ref. piping diameter	Liquid	mm	19.05	19.05
	Gas	mm	41.28	41.28
Fan ^{*5}	Type x quantity		Propeller fan x 6	Propeller fan x 6
	Air flow	m ³ /min	270 + 305 + 305	305 + 305 + 305
Compressor	Type		Inverter scroll hermetic compressor	
	Motor output	kW	9.8 + 11.1 + 11.1	11.1 + 11.1 + 11.1
External dimensions	H(H ^{*5})xWxD	mm	1858(1798)x1240x740	1858(1798)x1240x740
			1858(1798)x1240x740	1858(1798)x1240x740
			1858(1798)x1240x740	1858(1798)x1240x740
Net weight		kg	303 + 303 + 303	303 + 303 + 303
Refrigerant	Ref. Charge R410	kg	32,4	32,4
	CO ₂ eq.	Tons	67,65	67,65

^{*1,2,3} Nominal conditions (subject to JIS B8615-2)

	Indoor	Outdoor	Pipe length	Level difference
Cooling	27°C DB/19°C WB	35°C DB	7.5m	0m
Heating	20°C DB	7°C DB/6°C WB	7.5m	0m

^{*3} Eurovent registered

^{*4} Cooling mode / Heating mode

^{*5} The sound pressure level measured by the conventional method in JIS for reference purpose.

^{*6} External static pressure option is available (30 Pa, 60 Pa, 80 Pa/3.1 mmH₂O, 6.1 mmH₂O, 8.2 mmH₂O).

Consult your dealer about the specification when setting External static pressure option.

*Due to continuing improvement, above specifications may be subject to change without notice.

office



R2 NEXT STAGE LINE

OUTDOOR UNITS - PURY-(E)P Y(S)NW-A2(-BS)



NEW FOUR-SIDED BATTERY

STATIC PRESSURE OF FAN INCREASED UP TO 80 PA.

CITY MULTI

NEW FAN WITH LOW FRICTION PROFILE

COMPRESSOR OPTIMISED WITH "MULTI-PORT" TECHNOLOGY

NEW AUTO-SHIFT MODE

NEW AUTO-SHIFT MODE PREHEAT DEFROST FUNCTION

ADVANCED ETC CONTROL OF EVAPORATION TEMPERATURE.

FLEXIBLE NOISE SETTING

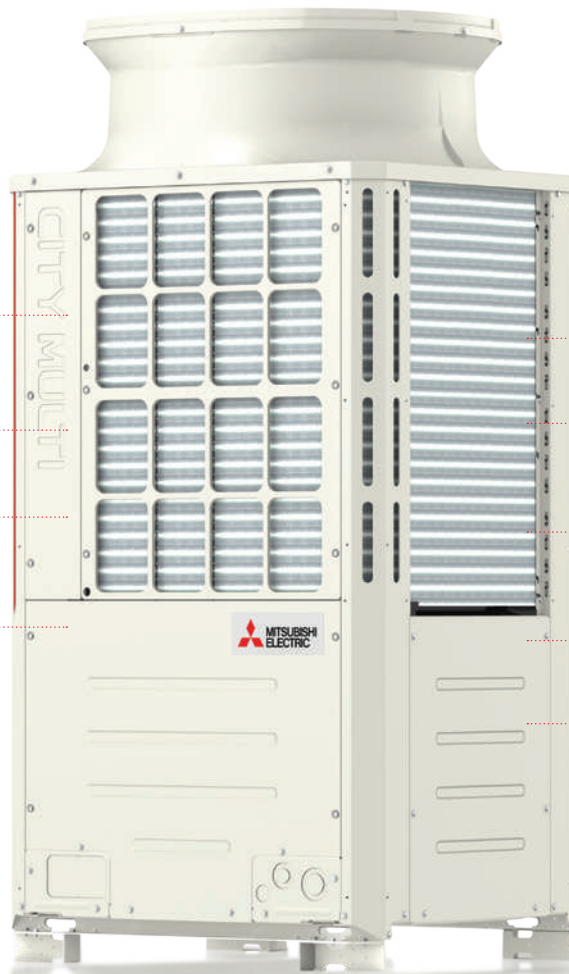

New design

The new outdoor units of the YNW series use a four-sided heat exchanger close to the top of the case near the fan. This technological and construction choice makes it possible to increase heat exchange efficiency.

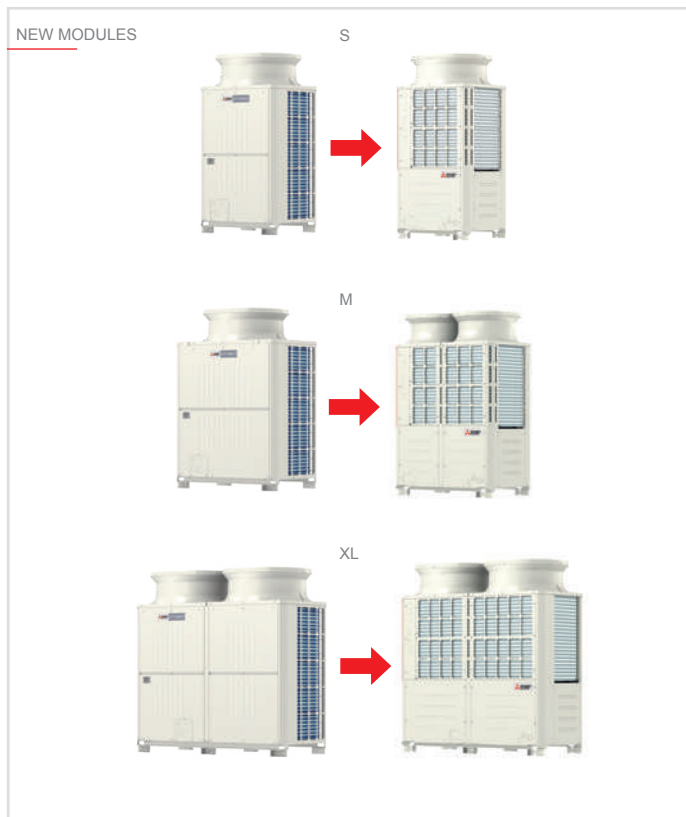
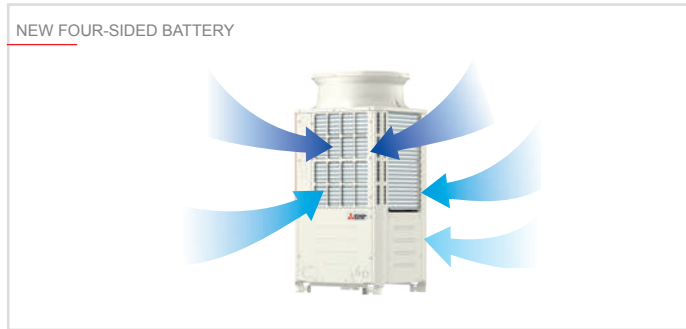

New fan with new blade profile

The fan of the new YNW series has been completely redesigned to fit with the new four-sided battery. The profile of the fins has been optimised to minimise fluid flow losses.

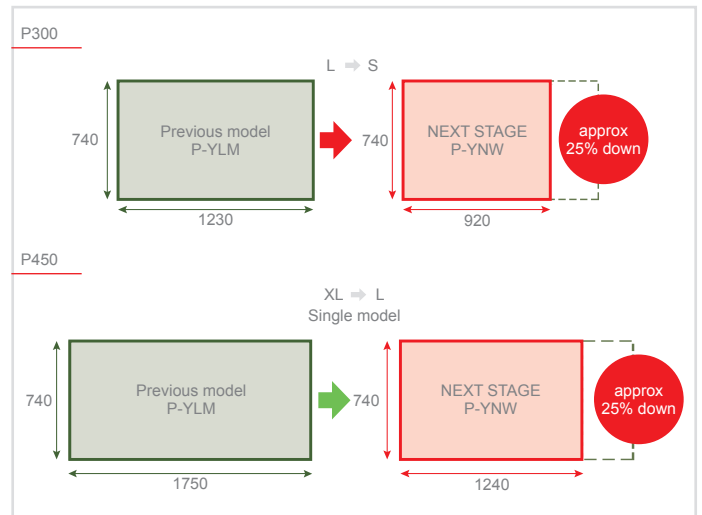
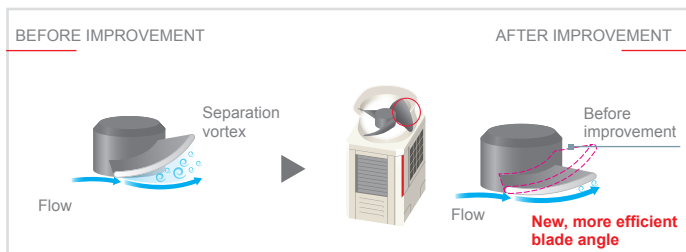

Energy saving

Energy efficiency has been further improved compared to YLM units and now hits top of the range performance values. SEER values have been raised by 139% (P500) compared to the previous model and SCOP values by 49% (P300 and P500). This allows the new YNW units to consume less energy in both cooling and heating. All year-round saving.



Single module

		Previous model	YNW
8HP	P200	S	S
10HP	P250	S	S
12HP	P300	L	S
14HP	P350	L	L
16HP	P400	L	L
18HP	P450	XL	L
20HP	P500	XL	XL

Advanced “Low Noise” function

Low noise” mode can now be selected using five different settings: 85%, 70%, 60% and 50% (values referring to ventilation speed). Noise reduction is directly configurable from the control board of the outdoor unit. Different settings can be selected depending on the installation requirements (in applications with special noise constraints).

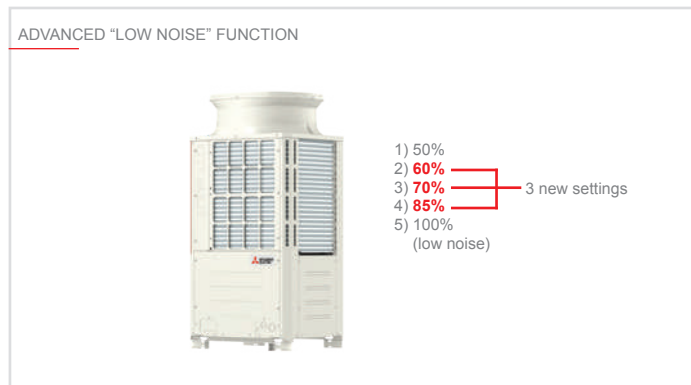

New BC distributor

Increased number of connections (for systems with BC SUB distributor) and increased geometric limits. In the R2 heat recovery systems of the new YNW line, up to 11 BC SUB distributors can be connected to the BC Main distributor, thus allowing greater flexibility of configuration. The adoption of the new architecture allows a reduction of the refrigerant charge in the system.

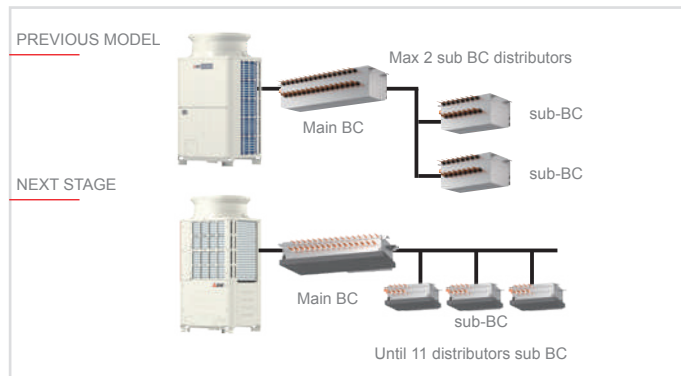

Key Technologies

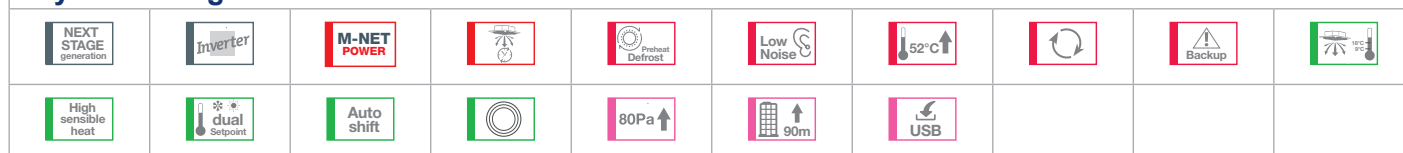

Technical specifications

MODEL		PURY-P200YNW-A2(-BS)	PURY-P250YNW-A2(-BS)	PURY-P300YNW-A2(-BS)	PURY-P350YNW-A2(-BS)	PURY-P400YNW-A2(-BS)	
HP		8	10	12	14	16	
Modules		PURY-P200YNW-A2	PURY-P250YNW-A2	PURY-P300YNW-A2	PURY-P350YNW-A2	PURY-P400YNW-A2	
Power supply	V/Hz/n°	3-phase 4-wire 380-400-415 V 50/60 Hz					
Cooling	Capacity (nominal) *1	kW	22.4	28.0	33.5	40.0	45.0
	Power input (nominal)	kW	6.68	10.25	11.75	14.92	19.65
	SEER		7.27	6.85	6.34	5.98	5.82
	Temperature operating field	Indoor WB °C	15.0~24.0°C	15.0~24.0°C	15.0~24.0°C	15.0~24.0°C	15.0~24.0°C
	Outdoor DB °C	-5.0~52.0°C	-5.0~52.0°C	-5.0~52.0°C	-5.0~52.0°C	-5.0~52.0°C	
Heating	Capacity (nominal) *2/ Capacity (max) *2	kW	22.4/25.0	28.0/31.5	33.5/33.5	40.0/45.0	45.0/50.0
	Power input (nominal)/ Power input (max)	kW	5.38/6.79	7.36/9.57	9.62/9.62	10.89/13.88	13.39/16.66
	SCOP		4.01	4.01	4.01	3.53	3.51
	Temperature operating field**	Indoor DB °C	15.0~27.0°C	15.0~27.0°C	15.0~27.0°C	15.0~27.0°C	15.0~27.0°C
	Outdoor WB °C	-20.0~15.5°C	-20.0~15.5°C	-20.0~15.5°C	-20.0~15.5°C	-20.0~15.5°C	
Sound level *5*6	Sound pressure (Sound power) level	dB(A)	59/59 (76/76)	60.5/64 (78/83)	61/67 (80/86)	62.5/64 (81/83)	65/69 (83/88)
Connectable indoor units	Total Capacity	50~150% of outdoor unit capacity					
	Model/Quantity	CITY MULTI	P10~P250, M20~M140/1~20	P10~P250, M20~M140/1~25	P10~P250, M20~M140/1~30	P10~P250, M20~M140/1~35	P10~P250, M20~M140/1~40
Ø Ref. piping diameter	Liquid	mm	15.88	19.05	19.05	19.05	22.2
	Gas	mm	19.05	22.2	22.2	28.58	28.58
Fan**	Type x quantity		Propeller fan x 1	Propeller fan x 1	Propeller fan x 1	Propeller fan x 2	Propeller fan x 2
	Air flow	m³/min	170	220	240	250	315
Compressor	Type	Inverter scroll hermetic					
	Motor output	kW	5.0	8.0	9.2	12.0	16.1
External dimensions	HxWxD	mm	1858(1798)x920x740	1858(1798)x920x740	1858(1798)x920x740	1858(1798)x1240x740	1858(1798)x1240x740
Net weight		kg	214	223	225	269	269
Refrigerant	Ref. Charge R410	kg	5.2	5.2	5.2	8.0	8.0
	CO ₂ eq.	Tons	10.85	10.85	10.85	16.70	16.70

*1,*2,*3 Nominal conditions (subject to JIS B8615-2)

	Indoor	Outdoor	Pipe length	Level difference
Cooling	27°C DB/19°C WB	35°C DB	7.5m	0m
Heating	20°C DB	7°C DB/6°C WB	7.5m	0m

*3 Eurovent registered

*4 -10°C D.B. (14°F D.B.), -11°C W.B. (12°F W.B.) to 21°C D.B. (70°F D.B.)/15.5°C W.B. (60°F W.B.) with cooling/heating mixed operation.

*5 Cooling mode / Heating mode

*6 The sound pressure level measured by the conventional method in JIS for reference purpose.

*7 External static pressure option is available (30 Pa, 60 Pa, 80 Pa/3.1 mmH₂O, 6.1 mmH₂O, 8.2 mmH₂O).

Consult your dealer about the specification when setting External static pressure option.

*Due to continuing improvement, above specifications may be subject to change without notice.

Technical specifications

MODEL			PURY-P450YNW-A2(-BS)	PURY-P500YNW-A2(-BS)	PURY-P550YNW-A2(-BS)	PURY-P400YSNW-A2(-BS)	PURY-P450YSNW-A2(-BS)	PURY-P500YSNW-A2(-BS)	
HP			18	20	22	16	18	20	
Modules			PURY-P450YNW-A2	PURY-P500YNW-A2	PURY-P550YNW-A2	PURY-P(200+200)YNW-A2	PURY-P(200+250)YNW-A2	PURY-P(250+250)YNW-A2	
Power supply	V/Hz/n°	3-phase 4-wire 380-400-415 V 50/60 Hz							
Cooling	Capacity (nominal) *1	kW	50.0	56.0	60.0	44.8	50.4	56.0	
	Power input (nominal)	kW	19.84	22.22	25.86	13.78	17.08	21.13	
	SEER		6.38	6.24	6.25	7.05	6.85	6.64	
	Temperature operating field	Indoor WB	°C	15.0~24.0°C	15.0~24.0°C	15.0~24.0°C	15.0~24.0°C	15.0~24.0°C	15.0~24.0°C
Outdoor DB		°C	-5.0~52.0°C	-5.0~52.0°C	-5.0~52.0°C	-5.0~52.0°C	-5.0~52.0°C	-5.0~52.0°C	
Heating	Capacity (nominal) *3/ Capacity (max) *2	kW	50.0/56.0	56.0/63.0	63.0/69.0	44.8/50.0	50.4/56.5	56.0/63.0	
	Power input (nominal)/ Power input (max)	kW	15.33/18.79	16.76/21.14	20.00/24.55	11.08/14.00	13.05/16.71	15.17/19.74	
	SCOP		3.51	3.51	3.51	4.01	4.01	4.01	
	Temperature operating field**	Indoor DB	°C	15.0~27.0°C	15.0~27.0°C	15.0~27.0°C	15.0~27.0°C	15.0~27.0°C	15.0~27.0°C
		Outdoor WB	°C	-20.0~15.5°C	-20.0~15.5°C	-20.0~15.5°C	-20.0~15.5°C	-20.0~15.5°C	-20.0~15.5°C
Sound level *5*6	Sound pressure (Sound power) level	dB(A)	65.5/70 (83/89)	63.5/64.5 (82/84)	70.0/70.0 (89/89)	62/62 (79/79)	63/65.5 (81/84)	63.5/67 (81/86)	
Connectable indoor units	Total Capacity	50~150% of outdoor unit capacity							
	Model/Quantity	CITY MULTI	P10~P250, M20~M140/1~45	P10~P250, M20~M140/1~50	P10~P250, M20~M140/2~50	P10~P250, M20~M140/1~40	P10~P250, M20~M140/1~45	P10~P250, M20~M140/1~50	
Ø Ref. piping diameter	Liquid	mm	22.2	22.2	22.2	22.2	22.2	22.2	
	Gas	mm	28.58	28.58	28.58	28.58	28.58	28.58	
Fan*7	Type x quantity		Propeller fan x 2	Propeller fan x 2	Propeller fan x 2	Propeller fan x 2	Propeller fan x 2	Propeller fan x 2	
	Air flow	m³/min	315	295	410	170+170	170+220	220+220	
Compressor	Type	Inverter scroll hermetic							
	Motor output	kW	16.2	17.4	20.5	5.0+5.0	5.0+8.0	8.0+8.0	
External dimensions	HxWxD	mm	1858(1798)x1240x740	1858(1798)x1750x740	1858(1798)x1750x740	1858(1798)x920x740 1858(1798)x920x740	1858(1798)x920x740 1858(1798)x920x740	1858(1798)x920x740 1858(1798)x920x740	
Net weight		kg	289	335	335	214+214	214+223	223+223	
Refrigerant	Ref. Charge R410	kg	10.8	10.8	10.8	10.4	10.4	10.4	
	CO ₂ eq.	Tons	22.55	22.55	22.55	21.71	21.71	21.71	

Technical specifications

MODEL			PURY-P550YSNW-A2(-BS)	PURY-P600YSNW-A2(-BS)	PURY-P650YSNW-A2(-BS)	PURY-P700YSNW-A2(-BS)	PURY-P750YSNW-A2(-BS)	
HP			22	24	26	28	30	
Modules			PURY-P(250+300)YNW-A2	PURY-P(300+300)YNW-A2	PURY-P(300+350)YNW-A2	PURY-P(350+350)YNW-A2	PURY-P(350+400)YNW-A2	
Power supply	V/Hz/n°	3-phase 4-wire 380-400-415 V 50/60 Hz						
Cooling	Capacity (nominal) *1	kW	61.5	67.0	73.5	80.0	85.0	
	Power input (nominal)	kW	22.69	24.27	27.42	30.76	35.26	
	SEER		6.40	6.15	5.98	5.80	5.72	
	Temperature operating field	Indoor WB	°C	15.0~24.0°C	15.0~24.0°C	15.0~24.0°C	15.0~24.0°C	15.0~24.0°C
Outdoor DB		°C	-5.0~52.0°C	-5.0~52.0°C	-5.0~52.0°C	-5.0~52.0°C	-5.0~52.0°C	
Heating	Capacity (nominal) *3/ Capacity (max) *2	kW	61.5/65.0	67.0/67.0	73.5/78.5	80.0/90.0	85.0/95.0	
	Power input (nominal)/ Power input (max)	kW	17.42/19.81	19.82/19.81	21.18/24.07	22.47/28.66	24.92/31.35	
	SCOP		4.01	4.01	3.53	3.53	3.51	
	Temperature operating field**	Indoor DB	°C	15.0~27.0°C	15.0~27.0°C	15.0~27.0°C	15.0~27.0°C	15.0~27.0°C
		Outdoor WB	°C	-20.0~15.5°C	-20.0~15.5°C	-20.0~15.5°C	-20.0~15.5°C	-20.0~15.5°C
Sound level *5*6	Sound pressure (Sound power) level	dB(A)	64/69 (83/88)	64/70 (83/89)	65/69 (84/88)	65.5/67 (84/86)	67/70.5 (86/90)	
Connectable indoor units	Total Capacity	50~150% of outdoor unit capacity						
	Model/Quantity	CITY MULTI	P10~P250, M20~M140/2~50	P10~P250, M20~M140/2~50	P10~P250, M20~M140/2~50	P10~P250, M20~M140/2~50	P10~P250, M20~M140/2~50	
Ø Ref. piping diameter	Liquid	mm	22.2	22.2	28.58	28.58	28.58	
	Gas	mm	28.58	28.58	28.58	34.93	34.93	
Fan*7	Type x quantity		Propeller fan x 2	Propeller fan x 2	Propeller fan x 3	Propeller fan x 4	Propeller fan x 4	
	Air flow	m³/min	220+240	240+240	240+250	250+250	250+315	
Compressor	Type	Inverter scroll hermetic						
	Motor output	kW	8.0+9.2	9.2+9.2	9.2+12.0	12.0+12.0	12.0+16.1	
External dimensions	HxWxD	mm	1858(1798)x920x740 1858(1798)x920x740	1858(1798)x920x740 1858(1798)x920x740	1858(1798)x920x740 1858(1798)x1240x740	1858(1798)x1240x740 1858(1798)x1240x740	1858(1798)x1240x740 1858(1798)x1240x740	
Net weight		kg	223+225	225+225	225+269	269+269	269+269	
Refrigerant	Ref. Charge R410	kg	10.4	10.4	13.2	16	16	
	CO ₂ eq.	Tons	21.71	21.71	27.56	33.40	33.40	

*1,2,3 Nominal conditions (subject to JIS B8615-2)

	Indoor	Outdoor	Pipe length	Level difference
Cooling	27°C DB/19°C WB	35°C DB	7.5m	0m
Heating	20°C DB	7°C DB/6°C WB	7.5m	0m

*3 Eurovent registered

*4 -10°C D.B. (14°F D.B.)/-11°C W.B. (12°F W.B.) to 21°C D.B. (70°F D.B.)/15.5°C W.B. (60°F W.B.) with cooling/heating mixed operation.

*5 Cooling mode / Heating mode

*6 The sound pressure level measured by the conventional method in JIS for reference purpose.

*7 External static pressure option is available (30 Pa, 60 Pa, 80 Pa/3.1 mmH₂O, 6.1 mmH₂O, 8.2 mmH₂O).

Consult your dealer about the specification when setting External static pressure option.

*Due to continuing improvement, above specifications may be subject to change without notice.

Technical specifications

MODEL			PURY-P800YSNW-A2(-BS)	PURY-P850YSNW-A2(-BS)	PURY-P900YSNW-A2(-BS)	PURY-P950YSNW-A2(-BS)	PURY-P1000YSNW-A2(-BS)	
HP			32	34	36	38	40	
Modules			PURY-P(400+400)YNW-A2	PURY-P(400+450)YNW-A2	PURY-P(450+450)YNW-A2	PURY-P(450+500)YNW-A2	PURY-P(500+500)YNW-A2	
Power supply	V/Hz/n*		3-phase 4-wire 380-400-415 V 50/60 Hz					
Cooling	Capacity (nominal) **1	kW	90.0	95.0	100.0	106.0	112.0	
	Power input (nominal)	kW	40.54	40.77	40.98	43.44	45.90	
	SEER		5.65	5.92	6.19	6.12	6.05	
	Temperature operating field	Indoor WB	°C	15.0~24.0°C	15.0~24.0°C	15.0~24.0°C	15.0~24.0°C	15.0~24.0°C
Outdoor DB		°C	-5.0~52.0°C	-5.0~52.0°C	-5.0~52.0°C	-5.0~52.0°C	-5.0~52.0°C	
Heating	Capacity (nominal) **2/ Capacity (max) **2	kW	90.0/100.0	95.0/106.0	100.0/112.0	106.0/119.0	112.0/126.0	
	Power input (nominal)/ Power input (max)	kW	27.60/34.36	29.59/36.55	31.64/38.75	33.12/41.17	34.56/43.59	
	SCOP		3.51	3.51	3.51	3.51	3.51	
	Temperature operating field**4	Indoor DB	°C	15.0~27.0°C	15.0~27.0°C	15.0~27.0°C	15.0~27.0°C	15.0~27.0°C
		Outdoor WB	°C	-20.0~15.5°C	-20.0~15.5°C	-20.0~15.5°C	-20.0~15.5°C	-20.0~15.5°C
Sound level **5#6	Sound pressure (Sound power) level	dB(A)	68/72 (86/91)	68.5/72.5 (86/92)	68.5/73.0 (86/92)	68/71.5 (86/91)	66.5/67.5 (85/87)	
Connectable indoor units	Total Capacity	50~150% of outdoor unit capacity						
	Model/Quantity	CITY MULTI	P10~P250, M20~M140/2~50	P10~P250, M20~M140/2~50	P10~P250, M20~M140/2~50	P10~P250, M20~M140/2~50	P10~P250, M20~M140/2~50	
Ø Ref. piping diameter	Liquid	mm	28.58	28.58	28.58	28.58	28.58	
	Gas	mm	34.93	41.28	41.28	41.28	41.28	
Fan**7	Type x quantity		Propeller fan x 4	Propeller fan x 4	Propeller fan x 4	Propeller fan x 4	Propeller fan x 4	
	Air flow	m ³ /min	315+315	315+315	315+315	315+295	295+295	
Compressor	Type	Inverter scroll hermetic						
	Motor output	kW	16.1+16.1	16.1+16.2	16.2+16.2	16.2+17.4	17.4+17.4	
External dimensions	HxWxD	mm	1858(1798)x1240x740 1858(1798)x1240x740	1858(1798)x1240x740 1858(1798)x1240x740	1858(1798)x1240x740 1858(1798)x1240x740	1858(1798)x1240x740 1858(1798)x1240x740	1858(1798)x1240x740 1858(1798)x1240x740	
	Net weight	kg	269+269	269+289	289+289	289+335	335+335	
Refrigerant	Ref. Charge R410	kg	16	18.8	21.6	21.6	21.6	
	CO ₂ eq.	Tons	33.40	39.25	45.1	45.1	45.1	

Technical specifications

MODEL			PURY-P1050YSNW-A2(-BS)	PURY-P1100YSNW-A2(-BS)	
HP			42	44	
Modules			PURY-P(500+550)YNW-A2	PURY-P(550+550)YNW-A2	
Power supply	V/Hz/n*		3-phase 4-wire 380-400-415 V 50/60 Hz		
Cooling	Capacity (nominal) **1	kW	116.0	120.0	
	Power input (nominal)	kW	49.36	53.32	
	SEER		6.06	6.06	
	Temperature operating field	Indoor WB	°C	15.0~24.0°C	15.0~24.0°C
Outdoor DB		°C	-5.0~52.0°C	-5.0~52.0°C	
Heating	Capacity (nominal) **2/ Capacity (max) **2	kW	119.0/132.0	126.0/138.0	
	Power input (nominal)/ Power input (max)	kW	37.77/46.97	41.17/50.54	
	SCOP		3.51	3.51	
	Temperature operating field**4	Indoor DB	°C	15.0~27.0°C (59~81°F)	15.0~27.0°C
		Outdoor WB	°C	-20.0~15.5°C (-4~60°F)	-20.0~15.5°C
Sound level **5#6	Sound pressure (Sound power) level	dB(A)	71.0/71.5 (90/91)	73.0/73.0 (92/92)	
Connectable indoor units	Total Capacity	50~150% of outdoor unit capacity			
	Model/Quantity	CITY MULTI	P10~P250, M20~M140/3~50	P10~P250, M20~M140/3~50	
Ø Ref. piping diameter	Liquid	mm	34.93	34.93	
	Gas	mm	41.28	41.28	
Fan**7	Type x quantity		Propeller fan x 4	Propeller fan x 4	
	Air flow	m ³ /min	295+410	410+410	
Compressor	Type	Inverter scroll hermetic			
	Motor output	kW	17.4+20.5	20.5+20.5	
External dimensions	HxWxD	mm	1858(1798)x1750x740 1858(1798)x1750x740	1858(1798)x1750x740 1858(1798)x1750x740	
	Net weight	kg	335+335	335+335	
Refrigerant	Ref. Charge R410	kg	21.6	21.6	
	CO ₂ eq.	Tons	45.1	45.1	

*1,2,3 Nominal conditions (subject to JIS B8615-2)

	Indoor	Outdoor	Pipe length	Level difference
Cooling	27°C DB/19°C WB	35°C DB	7.5m	0m
Heating	20°C DB	7°C DB/6°C WB	7.5m	0m

**3 Eurovent registered

**4 -10°C D.B. (14°F D.B.)/-11°C W.B. (12°F W.B.) to 21°C D.B. (70°F D.B.)/15.5°C W.B. (60°F W.B.) with cooling/heating mixed operation.

**5 Cooling mode / Heating mode

**6 The sound pressure level measured by the conventional method in JIS for reference purpose.

**7 External static pressure option is available (30 Pa, 60 Pa, 80 Pa/3.1 mmH₂O, 6.1 mmH₂O, 8.2 mmH₂O).

Consult your dealer about the specification when setting External static pressure option.

*Due to continuing improvement, above specifications may be subject to change without notice.

Technical specifications

MODEL			PURY-EP200YNW-A2(-BS)	PURY-EP250YNW-A2(-BS)	PURY-EP300YNW-A2(-BS)	PURY-EP350YNW-A2(-BS)	PURY-EP400YNW-A2(-BS)	
HP			8	10	12	14	16	
Modules			PURY-EP200YNW-A2	PURY-EP250YNW-A2	PURY-EP300YNW-A2	PURY-EP350YNW-A2	PURY-EP400YNW-A2	
Power supply	V/Hz/n°		3-phase 4-wire 380-400-415 V 50/60 Hz					
Cooling	Capacity (nominal) *1	kW	22.4	28.0	33.5	40.0	45.0	
	Power input (nominal)	kW	6.38	9.75	11.20	14.23	18.75	
	SEER		7.45	7.05	6.48	6.03	6.10	
	Temperature operating field	Indoor WB	°C	15.0~24.0°C	15.0~24.0°C	15.0~24.0°C	15.0~24.0°C	15.0~24.0°C
Outdoor DB		°C	-5.0~52.0°C	-5.0~52.0°C	-5.0~52.0°C	-5.0~52.0°C	-5.0~52.0°C	
Heating	Capacity (nominal) *3/ Capacity (max) *2	kW	22.4 / 25.0	28.0 / 31.5	33.5 / 37.5	40.0 / 45.0	45.0 / 50.0	
	Power input (nominal)/ Power input (max)	kW	5.37 / 6.72	7.31 / 9.51	9.59 / 10.90	10.63 / 13.39	13.15 / 16.33	
	SCOP		3.51	3.51	3.54	3.56	3.57	
	Temperature operating field**	Indoor DB	°C	15.0~27.0°C	15.0~27.0°C	15.0~27.0°C	15.0~27.0°C	15.0~27.0°C
		Outdoor WB	°C	-20.0~15.5°C	-20.0~15.5°C	-20.0~15.5°C	-20.0~15.5°C	-20.0~15.5°C
Sound level *5*6	Sound pressure (Sound power) level	dB(A)	59.0/59.0 (76/76)	60.5/61.0 (78/80)	61.0/67.0 (80/86)	62.5/64.0 (81/83)	65.0/69.0 (83/88)	
Connectable indoor units	Total Capacity	50~150% of outdoor unit capacity						
	Model/Quantity	CITY MULTI	P10-P250, M20-M140/1-20	P10-P250, M20-M140/1-25	P10-P250, M20-M140/1-30	P10-P250, M20-M140/1-35	P10-P250, M20-M140/1-40	
Ø Ref. piping diameter	Liquid	mm	15.88	19.05	19.05	19.05	22.2	
	Gas	mm	19.05	22.2	22.2	28.58	28.58	
Fan*7	Type x quantity		Propeller fan x 1	Propeller fan x 1	Propeller fan x 1	Propeller fan x 2	Propeller fan x 2	
	Air flow	m³/min	170	185	240	250	315	
Compressor	Type	Inverter scroll hermetic						
	Motor output	kW	4.9	7.5	8.8	11.4	15.3	
External dimensions	HxWxD	mm	1858(1798)x920x740	1858(1798)x920x740	1858(1798)x920x740	1858(1798)x1240x740	1858(1798)x1240x740	
Net weight		kg	219	228	230	275	276	
Refrigerant	Ref. Charge R410	kg	5.2	5.2	5.2	8.0	8.0	
	CO ₂ eq.	Tons	10.85	10.85	10.85	16.70	16.70	

Technical specifications

MODEL			PURY-EP450YNW-A2(-BS)	PURY-EP500YNW-A2(-BS)	PURY-EP550YNW-A2(-BS)	PURY-EP400YSNW-A2(-BS)	PURY-EP450YSNW-A2(-BS)	
HP			18	20	22	16	18	
Modules			PURY-EP450YNW-A2	PURY-EP500YNW-A2	PURY-EP550YNW-A2	PURY-EP(200+200)YNW-A2	PURY-EP(200+250)YNW-A2	
Power supply	V/Hz/n°		3-phase 4-wire 380-400-415 V 50/60 Hz					
Cooling	Capacity (nominal) *1	kW	50.0	56.0	60.0	44.8	50.4	
	Power input (nominal)	kW	18.93	21.78	25.70	13.17	16.31	
	SEER		6.58	6.38	6.40	7.23	7.03	
	Temperature operating field	Indoor WB	°C	15.0~24.0°C	15.0~24.0°C	15.0~24.0°C	15.0~24.0°C	15.0~24.0°C
Outdoor DB		°C	-5.0~52.0°C	-5.0~52.0°C	-5.0~52.0°C	-5.0~52.0°C	-5.0~52.0°C	
Heating	Capacity (nominal) *3/ Capacity (max) *2	kW	50.0 / 56.0	56.0 / 63.0	63.0 / 69.0	44.8 / 50.0	50.4 / 56.5	
	Power input (nominal)/ Power input (max)	kW	14.61 / 18.36	16.66 / 21.00	19.81 / 23.87	11.08 / 13.85	12.98 / 16.56	
	SCOP		3.56	3.54	3.51	3.51	3.51	
	Temperature operating field**	Indoor DB	°C	15.0~27.0°C	15.0~27.0°C	15.0~27.0°C	15.0~27.0°C	15.0~27.0°C
		Outdoor WB	°C	-20.0~15.5°C	-20.0~15.5°C	-20.0~15.5°C	-20.0~15.5°C	-20.0~15.5°C
Sound level *5*6	Sound pressure (Sound power) level	dB(A)	65.5/70.0 (83/89)	63.5/64.5 (82/84)	70.0/70.0 (89/89)	62.0/62.0 (79/79)	63.0/63.5 (81/82)	
Connectable indoor units	Total Capacity	50~150% of outdoor unit capacity						
	Model/Quantity	CITY MULTI	P10-P250, M20-M140/1-45	P10-P250, M20-M140/1-50	P10-P250, M20-M140/2-50	P10-P250, M20-M140/1-40	P10-P250, M20-M140/1-45	
Ø Ref. piping diameter	Liquid	mm	22.2	22.2	22.2	22.2	22.2	
	Gas	mm	28.58	28.58	28.58	28.58	28.58	
Fan*7	Type x quantity		Propeller fan x 2	Propeller fan x 2	Propeller fan x 2	Propeller fan x 2	Propeller fan x 2	
	Air flow	m³/min	315	295	410	170 + 170	170 + 185	
Compressor	Type	Inverter scroll hermetic						
	Motor output	kW	15.5	17.0	20.4	4.9 + 4.9	4.9 + 7.5	
External dimensions	HxWxD	mm	1858(1798)x1240x740	1858(1798)x1750x740	1858(1798)x1750x740	1858(1798)x920x740 1858(1798)x920x740	1858(1798)x920x740 1858(1798)x920x740	
Net weight		kg	301	346	346	219 + 219	219 + 228	
Refrigerant	Ref. Charge R410	kg	10.8	10.8	10.8	10.4	10.4	
	CO ₂ eq.	Tons	22.55	22.55	22.55	21.71	21.71	

*1,*2,*3 Nominal conditions (subject to JIS B8615-2)

	Indoor	Outdoor	Pipe length	Level difference
Cooling	27°C DB/19°C WB	35°C DB	7.5m	0m
Heating	20°C DB	7°C DB/6°C WB	7.5m	0m

*3 Eurovent registered

*4 -10°C D.B. (14°F D.B.)/-11°C W.B. (12°F W.B.) to 21°C D.B. (70°F D.B.)/15.5°C W.B. (60°F W.B.) with cooling/heating mixed operation.

*5 Cooling mode / Heating mode

*6 The sound pressure level measured by the conventional method in JIS for reference purpose.

*7 External static pressure option is available (30 Pa, 60 Pa, 80 Pa/3.1 mmH₂O, 6.1 mmH₂O, 8.2 mmH₂O).

Consult your dealer about the specification when setting External static pressure option.

*Due to continuing improvement, above specifications may be subject to change without notice.

Technical specifications

MODEL		PURY-EP500YSNW-A2(-BS)	PURY-EP550YSNW-A2(-BS)	PURY-EP600YSNW-A2(-BS)	PURY-EP650YSNW-A2(-BS)	PURY-EP700YSNW-A2(-BS)		
HP		20	22	24	26	28		
Modules		PURY-EP(250+250)YNW-A2	PURY-EP(250+300)YNW-A2	PURY-EP(300+300)YNW-A2	PURY-EP(300+350)YNW-A2	PURY-EP(350+350)YNW-A2		
Power supply	V/Hz/n°	3-phase 4-wire 380-400-415 V 50/60 Hz						
Cooling	Capacity (nominal) *1	kW	56.0	61.5	67.0	73.5	80.0	
	Power input (nominal)	kW	20.14	21.65	23.10	26.15	29.30	
	SEER		6.84	6.56	6.29	6.07	5.85	
	Temperature operating field	Indoor WB	°C	15.0~24.0°C	15.0~24.0°C	15.0~24.0°C	15.0~24.0°C	15.0~24.0°C
Outdoor DB		°C	-5.0~52.0°C	-5.0~52.0°C	-5.0~52.0°C	-5.0~52.0°C	-5.0~52.0°C	
Heating	Capacity (nominal) *2/ Capacity (max) *2	kW	56.0 / 63.0	61.5 / 69.0	67.0 / 75.0	73.5 / 82.5	80.0 / 90.0	
	Power input (nominal)/ Power input (max)	kW	15.05 / 19.62	17.32 / 21.10	19.76 / 22.45	20.88 / 25.00	21.91 / 27.60	
	SCOP		3.51	3.51	3.54	3.54	3.56	
	Temperature operating field**	Indoor DB	°C	15.0~27.0°C	15.0~27.0°C	15.0~27.0°C	15.0~27.0°C	15.0~27.0°C
		Outdoor WB	°C	-20.0~15.5°C	-20.0~15.5°C	-20.0~15.5°C	-20.0~15.5°C	-20.0~15.5°C
Sound level *5*6	Sound pressure (Sound power) level	dB(A)	63.5/64.0 (81/83)	64.0/68.0 (83/87)	64.0/70.0 (83/89)	65.0/69.0 (84/88)	65.5/67.0 (84/86)	
Connectable indoor units	Total Capacity		50~150% of outdoor unit capacity					
	Model/Quantity	CITY MULTI	P10~P250, M20~M140/1~50	P10~P250, M20~M140/2~50	P10~P250, M20~M140/2~50	P10~P250, M20~M140/2~50	P10~P250, M20~M140/2~50	
Ø Ref. piping diameter	Liquid	mm	22.2	22.2	22.2	28.58	28.58	
	Gas	mm	28.58	28.58	28.58	28.58	34.93	
Fan*7	Type x quantity		Propeller fan x 2	Propeller fan x 2	Propeller fan x 2	Propeller fan x 3	Propeller fan x 4	
	Air flow	m³/min	185 + 185	185 + 240	240 + 240	240 + 250	250 + 250	
Compressor	Type		Inverter scroll hermetic					
	Motor output	kW	7.5 + 7.5	7.5 + 8.8	8.8 + 8.8	8.8 + 11.4	11.4 + 11.4	
External dimensions	HxWxD	mm	1858(1798)x920x740 1858(1798)x920x740	1858(1798)x920x740 1858(1798)x920x740	1858(1798)x920x740 1858(1798)x920x740	1858(1798)x920x740 1858(1798)x1240x740	1858(1798)x1240x740 1858(1798)x1240x740	
	Net weight	kg	228 + 228	228 + 230	230 + 230	230 + 275	275 + 275	
Refrigerant	Ref. Charge R410	kg	10.4	10.4	10.4	13.2	16	
	CO ₂ eq.	Tons	21.71	21.71	21.71	27.56	33.40	

Technical specifications

MODEL		PURY-EP750YSNW-A2(-BS)	PURY-EP800YSNW-A2(-BS)	PURY-EP850YSNW-A2(-BS)	PURY-EP900YSNW-A2(-BS)	PURY-EP950YSNW-A2(-BS)		
HP		30	32	34	36	38		
Modules		PURY-EP(350+400)YNW-A2	PURY-EP(400+400)YNW-A2	PURY-EP(400+450)YNW-A2	PURY-EP(450+450)YNW-A2	PURY-EP(450+500)YNW-A2		
Power supply	V/Hz/n°	3-phase 4-wire 380-400-415 V 50/60 Hz						
Cooling	Capacity (nominal) *1	kW	85.0	90.0	95.0	100.0	106.0	
	Power input (nominal)	kW	33.59	38.62	38.93	39.06	41.89	
	SEER		5.88	5.92	6.15	6.38	6.29	
	Temperature operating field	Indoor WB	°C	15.0~24.0°C	15.0~24.0°C	15.0~24.0°C	15.0~24.0°C	15.0~24.0°C
Outdoor DB		°C	-5.0~52.0°C	-5.0~52.0°C	-5.0~52.0°C	-5.0~52.0°C	-5.0~52.0°C	
Heating	Capacity (nominal) *2/ Capacity (max) *2	kW	85.0 / 95.0	90.0 / 100.0	95.0 / 106.0	100.0 / 112.0	106.0 / 119.0	
	Power input (nominal)/ Power input (max)	kW	24.42 / 30.54	27.10 / 33.67	28.61 / 35.81	30.12 / 37.83	32.21 / 40.61	
	SCOP		3.56	3.57	3.56	3.56	3.54	
	Temperature operating field**	Indoor DB	°C	15.0~27.0°C	15.0~27.0°C	15.0~27.0°C	15.0~27.0°C	15.0~27.0°C
		Outdoor WB	°C	-20.0~15.5°C	-20.0~15.5°C	-20.0~15.5°C	-20.0~15.5°C	-20.0~15.5°C
Sound level *5*6	Sound pressure (Sound power) level	dB(A)	67.0/70.5 (86/90)	68.0/72.0 (86/91)	68.5/72.5 (86/92)	68.5/73.0 (86/92)	68.0/71.5 (86/91)	
Connectable indoor units	Total Capacity		50~150% of outdoor unit capacity					
	Model/Quantity	CITY MULTI	P10~P250, M20~M140/2~50	P10~P250, M20~M140/2~50	P10~P250, M20~M140/2~50	P10~P250, M20~M140/2~50	P10~P250, M20~M140/2~50	
Ø Ref. piping diameter	Liquid	mm	28.58	28.58	28.58	28.58	28.58	
	Gas	mm	34.93	34.93	41.28	41.28	41.28	
Fan*7	Type x quantity		Propeller fan x 4	Propeller fan x 4	Propeller fan x 4	Propeller fan x 4	Propeller fan x 4	
	Air flow	m³/min	250 + 315	315 + 315	315 + 315	315 + 315	315 + 295	
Compressor	Type		Inverter scroll hermetic					
	Motor output	kW	11.4 + 15.3	15.3 + 15.3	15.3 + 15.5	15.5 + 15.5	15.5 + 17.0	
External dimensions	HxWxD	mm	1858(1798)x1240x740 1858(1798)x1240x740	1858(1798)x1240x740 1858(1798)x1240x740	1858(1798)x1240x740 1858(1798)x1240x740	1858(1798)x1240x740 1858(1798)x1240x740	1858(1798)x1240x740 1858(1798)x1750x740	
	Net weight	kg	275 + 276	276 + 276	276 + 301	301 + 301	301 + 346	
Refrigerant	Ref. Charge R410	kg	16	16	18.8	21.6	21.6	
	CO ₂ eq.	Tons	33.40	37.58	39.25	45.1	45.1	

*1,*2,*3 Nominal conditions (subject to JIS B8615-2)

	Indoor	Outdoor	Pipe length	Level difference
Cooling	27°C DB/19°C WB	35°C DB	7.5m	0m
Heating	20°C DB	7°C DB/6°C WB	7.5m	0m

*3 Eurovent registered

*4 -10°C D.B. (14°F D.B.)/-11°C W.B. (12°F W.B.) to 21°C D.B. (70°F D.B.)/15.5°C W.B. (60°F W.B.) with cooling/heating mixed operation.

*5 Cooling mode / Heating mode

*6 The sound pressure level measured by the conventional method in JIS for reference purpose.

*7 External static pressure option is available (30 Pa, 60 Pa, 80 Pa/3.1 mmH₂O, 6.1 mmH₂O, 8.2 mmH₂O).

Consult your dealer about the specification when setting External static pressure option.

*Due to continuing improvement, above specifications may be subject to change without notice.

Technical specifications

MODEL			PURY-EP1000YSNW-A2(-BS)	PURY-EP1050YSNW-A2(-BS)	PURY-EP1100YSNW-A2(-BS)	
HP			40	42	44	
Modules			PURY-EP(500+500)YNW-A2	PURY-EP(500+550)YNW-A2	PURY-EP(550+550)YNW-A2	
Power supply	V/Hz/n°		3-phase 4-wire 380-400-415 V 50/60 Hz			
Cooling	Capacity (nominal) *1	kW	112.0	116.0	120.0	
	Power input (nominal)	kW	44.97	48.73	53.08	
	SEER		6.19	6.20	6.21	
	Temperature operating field	Indoor WB	°C	15.0~24.0°C	15.0~24.0°C	15.0~24.0°C
Outdoor DB		°C	-5.0~52.0°C	-5.0~52.0°C	-5.0~52.0°C	
Heating	Capacity (nominal) *3/ Capacity (max) *2	kW	112.0 / 126.0	119.0 / 132.0	126.0 / 138.0	
	Power input (nominal)/ Power input (max)	kW	34.35 / 43.29	37.53 / 46.15	40.90 / 49.28	
	SCOP		3.54	3.51	3.51	
	Temperature operating field*4	Indoor DB	°C	15.0~27.0°C	15.0~27.0°C	15.0~27.0°C
		Outdoor WB	°C	-20.0~15.5°C	-20.0~15.5°C	-20.0~15.5°C
Sound level *5*6	Sound pressure (Sound power) level	dB(A)	66.5/67.5 (85/87)	71.0/71.5 (90/91)	73.0/73.0 (92/92)	
Connectable indoor units	Total Capacity	50~150% of outdoor unit capacity				
	Model/Quantity	CITY MULTI	P10~P250, M20~M140/2~50	P10~P250, M20~M140/3~50	P10~P250, M20~M140/3~50	
Ø Ref. piping diameter	Liquid	mm	28.58	34.93	34.93	
	Gas	mm	41.28	41.28	41.28	
Fan*7	Type x quantity		Propeller fan x 4	Propeller fan x 4	Propeller fan x 4	
	Air flow	m³/min	295 + 295	295 + 410	410 + 410	
Compressor	Type	Inverter scroll hermetic				
	Motor output	kW	17.0 + 17.0	17.0 + 20.4	20.4 + 20.4	
External dimensions	HxWxD	mm	1858(1798)x1750x740	1858(1798)x1750x740	1858(1798)x1750x740	
			1858(1798)x1750x740	1858(1798)x1750x740	1858(1798)x1750x740	
Net weight		kg	346 + 346	346 + 346	346 + 346	
Refrigerant	Ref. Charge R410	kg	21.6	21.6	21.6	
	CO ₂ eq.	Tons	45.1	45.1	45.1	

*1,*2,*3 Nominal conditions (subject to JIS B8615-2)

	Indoor	Outdoor	Pipe length	Level difference
Cooling	27°C DB/19°C WB	35°C DB	7.5m	0m
Heating	20°C DB	7°C DB/6°C WB	7.5m	0m

*3 Eurovent registered

*4 -10°C D.B. (14°F D.B.)/-11°C W.B. (12°F W.B.) to 21°C D.B. (70°F D.B.)/15.5°C W.B. (60°F W.B.) with cooling/heating mixed operation.

*5 Cooling mode / Heating mode

*6 The sound pressure level measured by the conventional method in JIS for reference purpose.

*7 External static pressure option is available (30 Pa, 60 Pa, 80 Pa/3.1 mmH₂O, 6.1 mmH₂O, 8.2 mmH₂O).

Consult your dealer about the specification when setting External static pressure option.

*Due to continuing improvement, above specifications may be subject to change without notice.

WY WR2 LINE

OUTDOOR UNITS - Water condensed Heat pump and Heat recovery PQH(R)Y-P Y(S)LM-A1



WEIGHT REDUCED UP TO -44% COMPARED TO PREVIOUS MODEL

WIDER LINEUP INTRODUCING 14HP SIZE

SINGLE MODULE UP TO SIZE 24HP FOR EASIER INSTALLATION AND LESS ENCUMBRANCE

HIGHER EFFICIENCY THAN PREVIOUS MODEL (UP TO +20% EER AND +34% COP)



NEW CASE IN SMALL AND LARGE VERSIONS

EVAPORATING TEMPERATURE CONTROL (ETC) FEATURE AVAILABLE

WATER FLOW AUTOMATIC CONTROL WITH 0-10V INPUT

FOR SIZES P700-P900 (28-36HP) REDUCED OCCUPIED SURFACE.

*1 Values referring to the model PQHY-P600 YSLM-A compared to the same size as the previous series
*2 Value referred to the model P400 compared with the same size as the previous model

New Small and Large case

New water condensed outdoor units WY and WR2 are available in two module types: Small and Large. Large module allows capacity up to 24HP (69 kW in Cooling and 76,5 kW in Heating) with just one module, reducing occupied surface in installation site up to 50% compared to previous model. For double module configuration room saving can be up to 33%.

Weight reduction

A significant weight reduction compared to previous model, up to 44% with Large module, allows an easier installation and transportation of the unit.

Higher energy efficiency

New WY and WR2 model grants top of the class EER and COP performances. Energy efficiency has been improved for both single and double module, in Cooling and Heating, up to +34%. This type of systems are among the most efficient in the world, thanks to high performances and constant temperature attributes of geothermal application.

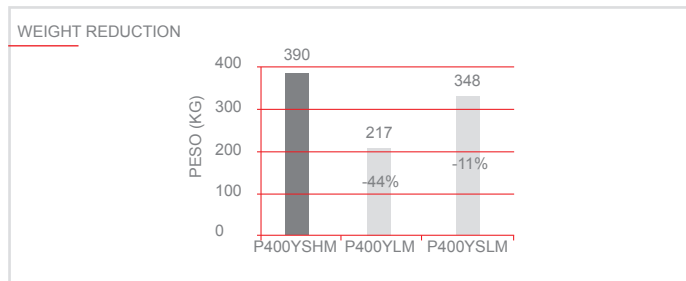

	PQHY		PQRY	
	Y(S)HM	Y(S)LM	Y(S)HM	Y(S)LM
P200	195	174	181	172
P250	195	174	181	172
P300	195	174	181	172
P350	-	217	-	216
P400	390	217 ¹	362	216 ¹
		348		344 ²
P450	390	217 ¹	362	216 ¹
		348		344 ²
P500	390	217 ¹	362	216 ¹
		348		344 ²
P550	390	246 ¹	362	246 ¹
		348 ²		344 ²
P600	390	246 ¹	362	246 ¹
		348 ²		344 ²
P700	585	434	-	432
P750	585	434	-	432
P800	585	434	-	432
P850	585	434	-	432
P900	585	434	-	432

*1 Single module
*2 Double module

NEW CASE

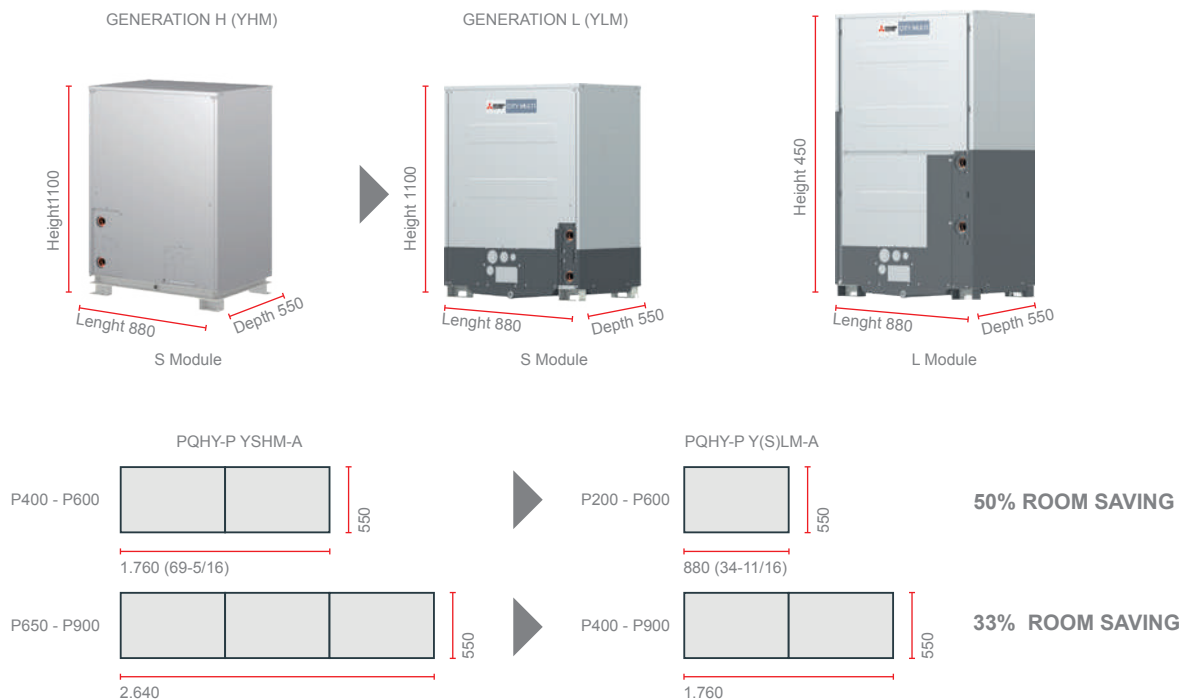

Water flow rate control

New YLM water condensed outdoor units are equipped with an automatic flow rate control system, which allows reduction of pumping consumption when the system works in partial load conditions. Flow rate control is performed by a 0-10V signal, which controls the regulation valve by shutting or opening it (field supplied).

Thanks to factory setting water circulation pumping is performed even during temporary blackout.

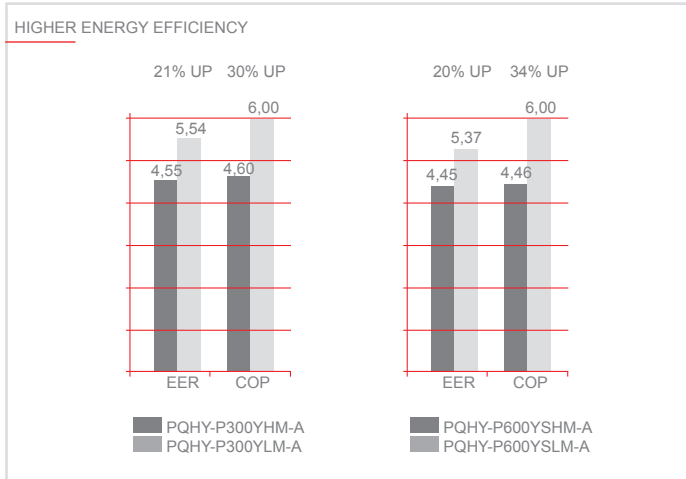

Advantages

WY and WR2 lines VRF CITY MULTI systems have all the benefits of the Y series, using water evaporation condensing units. Water heat source condensing units offer the advantage of being installable inside the building, for even greater installation flexibility with practically no limitations for the dimensions of the infrastructure. Depending on the capacity of the outdoor unit, up to 26 indoor units can be connected to a single condensing unit, while up to 50 indoor units can be connected to a modular system with individual user and/or centralized control. The two-pipe system allows the system to transition from heating to cooling mode and vice versa, for superior comfort in all zones.

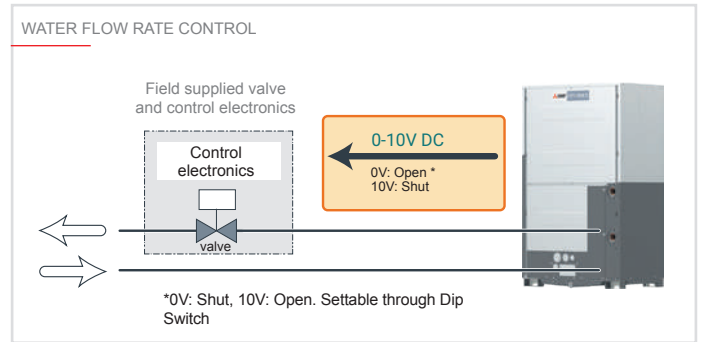







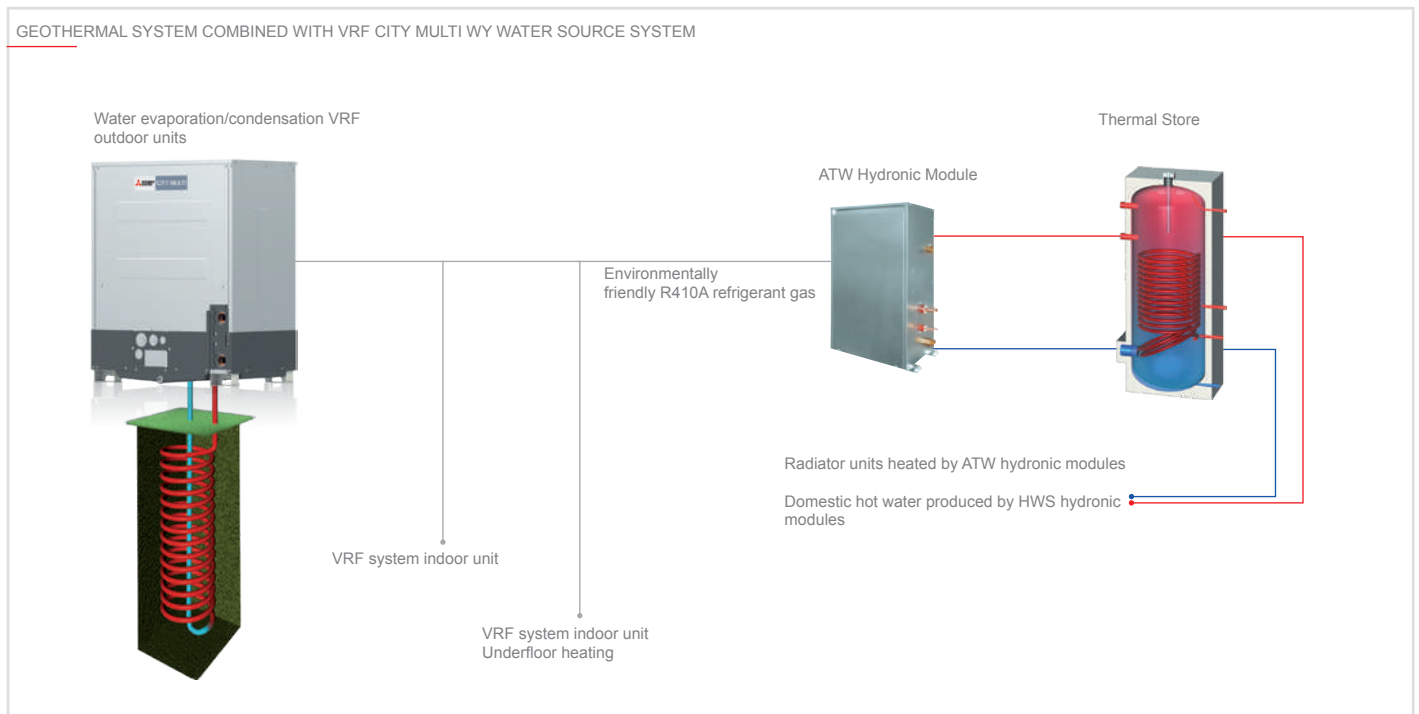

Geothermal applications

WY and WR2 lines outdoor units are perfectly suited for geothermal applications as they use water as the thermal medium fluid which, at depths from 10 m below ground, maintains a practically constant temperature with no significant excursions all year round.

A geothermal installation uses the ground as a heat source in winter and as a heat sink in summer. Using geothermal probes (heat exchangers) together with VRF CITY MULTI WY and WR2 systems, heat may be extracted from the ground to warm in winter, and dissipated into the ground to cool in summer.



Key Technologies

								
---	---	---	---	---	---	--	---	---

Technical specifications WY LINE

MODEL Single			PQHY-P200YLM-A1	PQHY-P250YLM-A1	PQHY-P300YLM-A1
HP			8	10	12
Power supply	Phases/Voltage/Freq.	V/Hz/n°	3-phase 380-400-415V 50Hz		
Cooling	Capacity*1	kW	22.4	28.0	33.5
	Power input	kW	3.71	4.90	6.04
	SEER		8.12	8.16	7.42
	Temperature operating field	Indoor WB	°C	15.0~24.0	15.0~24.0
Water		°C	10.0~45.0	10.0~45.0	10.0~45.0
Heating	Capacity*2	kW	25.0	31.5	37.5
	Power input	kW	3.97	5.08	6.25
	SCOP		4.90	4.61	4.55
	Temperature operating field	Indoor DB	°C	15.0~27.0	15.0~27.0
Water		°C	10.0~45.0	10.0~45.0	10.0~45.0
Sound power level*3			46	48	54
Connectable indoor units	Total capacity		50 to 130% of O.U. capacity	50 to 130% of O.U. capacity	50 to 130% of O.U. capacity
	Model/Quantity		P15~P250/1~17	P15~P250/1~21	P15~P250/1~26
Ø Ref. piping	Liquid	mm	9.52	9.52	9.52
	Gas	mm	19.05	22.2	22.2
Circulating Water	Flow rate	m³/h	5.76	5.76	5.76
	Operating volume range		3.0~7.2	3.0~7.2	3.0~7.2
	Pressure drop	kPa	24	24	24
	Heat exchanger volume	l	5.0	5.0	5.0
External dimensions			1100 x 880 x 550	1100 x 880 x 550	1100 x 880 x 550
Net weight			170	170	170
Ref. Charge R410*/CO ₂ Eq			5.0 / 10.44	5.0 / 10.44	5.0 / 10.44

*1 Nominal cooling conditions: Indoor: 27°C DB / 19°C WB. Water temperature 30°C. Piping length 7.5 m, vertical difference 0 m.

*2 Nominal heating conditions: Indoor 20°C DB. Water temperature 20°C. Piping length 7.5 m, vertical difference 0 m.

*3 Values measured in anechoic chamber.

** GWP value of HFC R410A 2088 according to 517 / 2014.

Technical specifications WY LINE

MODEL Single			PQHY-P350YLM-A1	PQHY-P400YLM-A1	PQHY-P450YLM-A1	PQHY-P500YLM-A1	PQHY-P550YLM-A1	PQHY-P600YLM-A1
HP			14	16	18	20	22	24
Power supply	Phases/Voltage/Freq.	V/Hz/n°	3-phase 380-400-415V 50Hz					
Cooling	Capacity*1	kW	40.0	45.0	50.0	56.0	63.0	69.0
	Power input	kW	7.14	8.03	9.29	11.17	12.54	14.49
	SEER		7.44	7.40	6.62	6.30	6.89	6.89
	Temperature operating field	Indoor WB	°C	15.0~24.0	15.0~24.0	15.0~24.0	15.0~24.0	15.0~24.0
Water		°C	10.0~45.0	10.0~45.0	10.0~45.0	10.0~45.0	10.0~45.0	10.0~45.0
Heating	Capacity*2	kW	45.0	50.0	56	63.0	69.0	76.5
	Power input	kW	7.53	8.37	9.79	11.43	12.27	14.51
	SCOP		4.29	4.25	4.17	4.04	3.77	3.51
	Temperature operating field	Indoor DB	°C	15.0~27.0	15.0~27.0	15.0~27.0	15.0~27.0	15.0~27.0
Water		°C	10.0~45.0	10.0~45.0	10.0~45.0	10.0~45.0	10.0~45.0	10.0~45.0
Sound power level*3			52	52	54	54	56.5	56.5
Connectable indoor units	Total capacity		50 to 130% of O.U. capacity	50 to 130% of O.U. capacity	50 to 130% of O.U. capacity	50 to 130% of O.U. capacity	50 to 130% of O.U. capacity	50 to 130% of O.U. capacity
	Model/Quantity		P15~P250/1~30	P15~P250/1~34	P15~P250/1~39	P15~P250/1~43	P15~P250/2~47	P15~P250/2~50
Ø Ref. piping	Liquid	mm	12.7	15.88	15.88	15.88	15.88	15.88
	Gas	mm	28.58	28.58	28.58	28.58	28.58	28.58
Circulating Water	Flow rate	m³/h	7.20	7.20	7.20	7.20	11.52	11.52
	Operating volume range		4.5~11.6	4.5~11.6	4.5~11.6	4.5~11.6	6.0~14.4	6.0~14.4
	Pressure drop	kPa	44	44	44	44	45	45
	Heat exchanger volume	l	5.0	5.0	5.0	5.0	10.0	10.0
External dimensions			1450 x 880 x 550	1450 x 880 x 550	1450 x 880 x 550	1450 x 880 x 550	1450 x 880 x 550	1450 x 880 x 550
Net weight			214	214	214	214	243	243
Ref. Charge R410*/CO ₂ Eq			6.0 / 12.53	6.0 / 12.53	6.0 / 12.53	6.0 / 12.53	11.7 / 24.43	11.7 / 24.43

*1 Nominal cooling conditions: Indoor: 27°C DB / 19°C WB. Water temperature 30°C. Piping length 7.5 m, vertical difference 0 m.

*2 Nominal heating conditions: Indoor 20°C DB. Water temperature 20°C. Piping length 7.5 m, vertical difference 0 m.

*3 Values measured in anechoic chamber.

** GWP value of HFC R410A 2088 according to 517 / 2014.

Technical specifications WY LINE

MODEL Double			PQHY-P400YSLM-A1	PQHY-P450YSLM-A1	PQHY-P500YSLM-A1	PQHY-P550YSLM-A1	PQHY-P600YSLM-A1	
HP			16	18	20	22	24	
Modules			PQHY-P200YLM-A1 PQHY-P200YLM-A1	PQHY-P250YLM-A1 PQHY-P200YLM-A1	PQHY-P250YLM-A1 PQHY-P250YLM-A1	PQHY-P300YLM-A1 PQHY-P250YLM-A1	PQHY-P300YLM-A1 PQHY-P300YLM-A1	
Twinning joint	CMY-Y100VBK3							
Power supply	Phases/Voltage/Freq.	V/Hz/n°	3 phase 380-400-415V 50Hz					
Cooling	Capacity*1	kW	45.0	50.0	56.0	63.0	69.0	
	Power input	kW	7.70	8.78	10.12	11.55	12.84	
	SEER		-	-	-	-	-	
	Temperature operating field	Indoor WB	°C	15.0~24.0	15.0~24.0	15.0~24.0	15.0~24.0	15.0~24.0
		Water	°C	10.0~45.0	10.0~45.0	10.0~45.0	10.0~45.0	10.0~45.0
Heating	Capacity*2	kW	50.0	56.0	63.0	69.0	76.5	
	Power input	kW	7.94	8.97	10.16	11.31	12.75	
	SCOP		-	-	-	-	-	
	Temperature operating field	Indoor DB	°C	15.0~27.0	15.0~27.0	15.0~27.0	15.0~27.0	15.0~27.0
		Water	°C	10.0~45.0	10.0~45.0	10.0~45.0	10.0~45.0	10.0~45.0
Sound power level*3		dB(A)	49	50	51	55	57	
Connectable indoor units	Total capacity		50 to 130% of O.U. capacity					
	Model/Quantity		P15~P250/1~34	P15~P250/1~39	P15~P250/1~43	P15~P250/2~47	P15~P250/2~50	
Ø Ref. piping	Liquid/Gas	mm	15.88/28.58	15.88/28.58	15.88/28.58	15.88/28.58	15.88/28.58	
Circulating Water	Flow rate	m³/h	5.76+5.76	5.76+5.76	5.76+5.76	5.76+5.76	5.76+5.76	
	Operating volume range		3+3~7.2+7.2	3+3~7.2+7.2	3+3~7.2+7.2	3+3~7.2+7.2	3+3~7.2+7.2	
	Pressure drop	kPa	24+24	24+24	24+24	24+24	24+24	
	Heat exchanger volume	l	5.0+5.0	5.0+5.0	5.0+5.0	5.0+5.0	5.0+5.0	
External dimensions		mm	1100 x 880 x 550	1100 x 880 x 550	1100 x 880 x 550	1100 x 880 x 550	1100 x 880 x 550	
			1100 x 880 x 550	1100 x 880 x 550	1100 x 880 x 550	1100 x 880 x 550	1100 x 880 x 550	
Net weight		kg	170+170	170+170	170+170	170+170	170+170	
Ref. Charge R410*/CO ₂ Eq		kg/Tons	5.0+5.0/20.88	5.0+5.0/20.88	5.0+5.0/20.88	5.0+5.0/20.88	5.0+5.0/20.88	

*1 Nominal cooling conditions: Indoor: 27°C DB / 19°C WB. Water temperature 30°C. Piping length 7.5 m, vertical difference 0 m.

*2 Nominal heating conditions: Indoor 20°C DB. Water temperature 20°C. Piping length 7.5 m, vertical difference 0 m.

*3 Values measured in anechoic chamber.

*4 GWP value of HFC R410A 2088 according to 517 / 2014.

Technical specifications WY LINE

MODEL Double			PQHY-P700YSLM-A1	PQHY-P750YSLM-A1	PQHY-P800YSLM-A1	PQHY-P850YSLM-A1	PQHY-P900YSLM-A1	
HP			28	30	32	34	36	
Modules			PQHY-P350YLM-A1 PQHY-P350YLM-A1	PQHY-P400YLM-A1 PQHY-P350YLM-A1	PQHY-P400YLM-A1 PQHY-P400YLM-A1	PQHY-P450YLM-A1 PQHY-P400YLM-A1	PQHY-P450YLM-A1 PQHY-P450YLM-A1	
Twinning joint	CMY-Y200VBK2							
Power supply	Phases/Voltage/Freq.	V/Hz/n°	3 phase 380-400-415V 50Hz					
Cooling	Capacity*1	kW	80.0	85.0	90.0	96.0	101.0	
	Power input	kW	14.73	15.64	16.57	18.03	19.38	
	SEER		-	-	-	-	-	
	Temperature operating field	Indoor WB	°C	15.0~24.0	15.0~24.0	15.0~24.0	15.0~24.0	15.0~24.0
		Water	°C	10.0~45.0	10.0~45.0	10.0~45.0	10.0~45.0	10.0~45.0
Heating	Capacity*2	kW	88.0	95.0	100.0	108.0	113.0	
	Power input	kW	14.73	15.90	16.75	18.49	19.74	
	SCOP		-	-	-	-	-	
	Temperature operating field	Indoor DB	°C	15.0~27.0	15.0~27.0	15.0~27.0	15.0~27.0	15.0~27.0
		Water	°C	10.0~45.0	10.0~45.0	10.0~45.0	10.0~45.0	10.0~45.0
Sound power level*3		dB(A)	55	55	55	56	57	
Connectable indoor units	Total capacity		50 to 130% of O.U. capacity					
	Model/Quantity		P15~P250/2~50	P15~P250/2~50	P15~P250/2~50	P15~P250/2~50	P15~P250/2~50	
Ø Ref. piping	Liquid/Gas	mm	19.05/34.93	19.05/34.93	19.05/34.93	19.05/41.28	19.05/41.28	
Circulating Water	Flow Rate	m³/h	7.20+7.20	7.20+7.20	7.20+7.20	7.20+7.20	7.20+7.20	
	Operating volume range		4.5+4.5~11.6+11.6	4.5+4.5~11.6+11.6	4.5+4.5~11.6+11.6	4.5+4.5~11.6+11.6	4.5+4.5~11.6+11.6	
	Pressure drop	kPa	44+44	44+44	44+44	44+44	44+44	
	Heat exchanger volume	l	5.0+5.0	5.0+5.0	5.0+5.0	5.0+5.0	5.0+5.0	
External dimensions		mm	1450 x 880 x 550	1450 x 880 x 550	1450 x 880 x 550	1450 x 880 x 550	1450 x 880 x 550	
			1450 x 880 x 550	1450 x 880 x 550	1450 x 880 x 550	1450 x 880 x 550	1450 x 880 x 550	
Net weight		kg	214+214	214+214	214+214	214+214	214+214	
Ref. Charge R410*/CO ₂ Eq		kg/Tons	6.0+6.0/25.06	6.0+6.0/25.06	6.0+6.0/25.06	6.0+6.0/25.06	6.0+6.0/25.06	

*1 Nominal cooling conditions: Indoor: 27°C DB / 19°C WB. Water temperature 30°C. Piping length 7.5 m, vertical difference 0 m.

*2 Nominal heating conditions: Indoor 20°C DB. Water temperature 20°C. Piping length 7.5 m, vertical difference 0 m.

*3 Values measured in anechoic chamber.

*4 GWP value of HFC R410A 2088 according to 517 / 2014.

Technical specifications WR2 LINE					
MODEL Single			PQRY-P200YLM-A1	PQRY-P250YLM-A1	PQRY-P300YLM-A1
HP			8	10	12
Power supply	Phases/Voltage/Freq.	V/Hz/n°	3 phase 380-400-415V 50Hz		
Cooling	Capacity*1	kW	22.4	28.0	33.5
	Power input	kW	3.71	4.90	6.04
	SEER		7.91	7.99	7.30
	Temperature operating field	Indoor WB	°C	15.0~24.0	15.0~24.0
Water		°C	10.0~45.0	10.0~45.0	10.0~45.0
Heating	Capacity*2	kW	25.0	31.5	37.5
	Power input	kW	3.97	5.08	6.25
	SCOP		4.90	4.61	4.55
	Temperature operating field	Indoor DB	°C	15.0~27.0	15.0~27.0
Water		°C	10.0~45.0	10.0~45.0	10.0~45.0
Sound power level*3		dB(A)	46	48	54
Connectable indoor units	Total capacity		50 to 150% of O.U. capacity	50 to 150% of O.U. capacity	50 to 150% of O.U. capacity
	Model/Quantity		P15~P250/1~20	P15~P250/1~25	P15~P250/1~30
Ø Ref. piping	Liquid	mm	15.88	19.05	19.05
	Gas	mm	19.05	22.2	22.2
Circulating Water	Flow Rate	m³/h	5.76	5.76	5.76
	Operating volume range		3.0~7.2	3.0~7.2	3.0~7.2
	Pressure drop	kPa	24	24	24
	Heat exchanger volume	l	5.0	5.0	5.0
External dimentions		mm	1100 x 880 x 550	1100 x 880 x 550	1100 x 880 x 550
Net weight		kg	173	173	173
Ref. Charge R410*/CO ₂ Eq		kg/Tons	5.0/10.44	5.0/10.44	5.0/10.44

*1 Nominal cooling conditions: Indoor: 27°C DB / 19°C WB. Water temperature 30°C. Piping length 7.5 m, vertical difference 0 m.

*2 Nominal heating conditions: Indoor 20°C DB. Water temperature 20°C. Piping length 7.5 m, vertical difference 0 m.

*3 Values measured in anechoic chamber.

*4 GWP value of HFC R410A 2088 according to 517 / 2014.

Technical specifications WR2 LINE								
MODEL Single			PQRY-P350YLM-A1	PQRY-P400YLM-A1	PQRY-P450YLM-A1	PQRY-P500YLM-A1	PQRY-P550YLM-A1	PQRY-P600YLM-A1
HP			14	16	18	20	22	24
Power supply	Phases/Voltage/Freq.	V/Hz/n°	3 phase 380-400-415V 50Hz					
Cooling	Capacity*1	kW	40.0	45.0	50.0	56.0	63.0	69.0
	Power input	kW	7.14	8.03	9.29	11.17	12.54	14.49
	SEER		7.34	7.31	6.56	6.25	6.84	6.84
	Temperature operating field	Indoor WB	°C	15.0~24.0	15.0~24.0	15.0~24.0	15.0~24.0	15.0~24.0
Water		°C	10.0~45.0	10.0~45.0	10.0~45.0	10.0~45.0	10.0~45.0	10.0~45.0
Heating	Capacity*2	kW	45.0	50.0	56.0	63.0	69.0	76.5
	Power input	kW	7.53	8.37	9.79	11.43	12.27	14.51
	SCOP		4.29	4.25	4.17	4.04	3.77	3.51
	Temperature operating field	Indoor DB	°C	15.0~27.0	15.0~27.0	15.0~27.0	15.0~27.0	15.0~27.0
Water		°C	10.0~45.0	10.0~45.0	10.0~45.0	10.0~45.0	10.0~45.0	10.0~45.0
Sound power level*3		dB(A)	52	52	54	54	56.5	56.5
Connectable indoor units	Total capacity		50 to 150% of O.U. capacity					
	Model/Quantity		P15~P250/1~35	P15~P250/1~40	P15~P250/1~45	P15~P250/1~50	P15~P250/2~50	P15~P250/2~50
Ø Ref. piping	Liquid	mm	22.2	22.2	22.2	22.2	22.2	22.2
	Gas	mm	28.58	28.58	28.58	28.58	28.58	34.93
Circulating Water	Flow Rate	m³/h	7.20	7.20	7.20	7.20	11.52	11.52
	Operating volume range		4.5~11.6	4.5~11.6	4.5~11.6	4.5~11.6	6.0~14.4	6.0~14.4
	Pressure drop	kPa	44	44	44	44	45	45
	Heat exchanger volume	l	5.0	5.0	5.0	5.0	10.0	10.0
External dimentions		mm	1450 x 880 x 550	1450 x 880 x 550	1450 x 880 x 550	1450 x 880 x 550	1450 x 880 x 550	1450 x 880 x 550
Net weight		kg	217	217	217	217	247	247
Ref. Charge R410*/CO ₂ Eq		kg/Tons	6.0/12.53	6.0/12.53	6.0/12.53	6.0/12.53	11.7/24.43	11.7/24.43

*1 Nominal cooling conditions: Indoor: 27°C DB / 19°C WB. Water temperature 30°C. Piping length 7.5 m, vertical difference 0 m.

*2 Nominal heating conditions: Indoor 20°C DB. Water temperature 20°C. Piping length 7.5 m, vertical difference 0 m.

*3 Values measured in anechoic chamber.

*4 GWP value of HFC R410A 2088 according to 517 / 2014

Technical specifications WR2 LINE

MODEL Double			PQRY-P400YSLM-A1	PQRY-P450YSLM-A1	PQRY-P500YSLM-A1	PQRY-P550YSLM-A1	PQRY-P600YSLM-A1
HP			16	18	20	22	24
Modules			PQRY-P200YLM-A1 PQRY-P200YLM-A1	PQRY-P250YLM-A1 PQRY-P200YLM-A1	PQRY-P250YLM-A1 PQRY-P250YLM-A1	PQRY-P300YLM-A1 PQRY-P250YLM-A1	PQRY-P300YLM-A1 PQRY-P300YLM-A1
Twinning joint	CMY-Q100VBK						
Power supply	Phases/Voltage/Freq.	V/Hz/n°	3-phase 380-400-415V 50Hz				
Cooling	Capacity*1	kW	45.0	50.0	56.0	63.0	69.0
	Power input	kW	7.70	8.78	10.12	11.55	12.84
	SEER		-	-	-	-	-
	Temperature operating field	Indoor WB Water	°C °C	15.0~24.0 10.0~45.0	15.0~24.0 10.0~45.0	15.0~24.0 10.0~45.0	15.0~24.0 10.0~45.0
Heating	Capacity*2	kW	50.0	56.0	63.0	69.0	76.5
	Power input	kW	7.94	8.97	10.16	11.31	12.75
	SCOP		-	-	-	-	-
	Temperature operating field	Indoor DB Water	°C °C	15.0~27.0 10.0~45.0	15.0~27.0 10.0~45.0	15.0~27.0 10.0~45.0	15.0~27.0 10.0~45.0
Sound power level*3			49	50	51	55	57
Connectable indoor units	Total capacity	50 to 150% of O.U. capacity					
	Model/Quantity	P15~P250/1~40		P15~P250/1~45	P15~P250/1~50	P15~P250/2~50	P15~P250/2~50
Ø Ref. piping	Liquid/Gas	mm	22.2/28.58	22.2/28.58	22.2/28.58	22.2/28.58	22.2/34.93
	Flow Rate	m³/h	5.76 + 5.76	5.76 + 5.76	5.76 + 5.76	5.76 + 5.76	5.76 + 5.76
Circulating Water	Operating volume range	3+3 ~ 7.2+7.2					
	Pressure drop	kPa	24 + 24	24 + 24	24 + 24	24 + 24	24 + 24
	Heat exchanger volume	l	5.0 + 5.0	5.0 + 5.0	5.0 + 5.0	5.0 + 5.0	5.0 + 5.0
	External dimentions	mm	1100 x 880 x 550 1100 x 880 x 550	1100 x 880 x 550 1100 x 880 x 550	1100 x 880 x 550 1100 x 880 x 550	1100 x 880 x 550 1100 x 880 x 550	1100 x 880 x 550 1100 x 880 x 550
Net weight	kg	173+173	173+173	173+173	173+173	173+173	
Ref. Charge R410*/CO ₂ Eq	kg/Tons	5.0+5.0 /20.88	5.0+5.0 /20.88	5.0+5.0 /20.88	5.0+5.0 /20.88	5.0+5.0 /20.88	

*1 Nominal cooling conditions: Indoor: 27°C DB / 19°C WB. Water temperature 30°C. Piping length 7.5 m, vertical difference 0 m.

*2 Nominal heating conditions: Indoor 20°C DB. Water temperature 20°C. Piping length 7.5 m, vertical difference 0 m.

*3 Values measured in anechoic chamber.

*4 GWP value of HFC R410A 2088 according to 517 / 2014

Technical specifications WR2 LINE

MODEL Double			PQRY-P700YSLM-A1	PQRY-P750YSLM-A1	PQRY-P800YSLM-A1	PQRY-P850YSLM-A1	PQRY-P900YSLM-A1
HP			28	30	32	34	36
Modules			PQRY-P350YLM-A1 PQRY-P350YLM-A1	PQRY-P400YLM-A1 PQRY-P350YLM-A1	PQRY-P400YLM-A1 PQRY-P400YLM-A1	PQRY-P450YLM-A1 PQRY-P400YLM-A1	PQRY-P450YLM-A1 PQRY-P450YLM-A1
Twinning joint	CMY-Q100VBK						
Power supply	Phases/Voltage/Freq.	V/Hz/n°	3-phase 380-400-415V 50Hz				
Cooling	Capacity*1	kW	80.0	85.0	90.0	96.0	101.0
	Power input	kW	14.73	15.64	16.57	18.03	19.38
	SEER		-	-	-	-	-
	Temperature operating field	Indoor WB Water	°C °C	15.0~24.0 10.0~45.0	15.0~24.0 10.0~45.0	15.0~24.0 10.0~45.0	15.0~24.0 10.0~45.0
Heating	Capacity*2	kW	88.0	95.0	100.0	108.0	113.0
	Power input	kW	14.73	15.90	16.75	18.49	19.74
	SCOP		-	-	-	-	-
	Temperature operating field	Indoor DB Water	°C °C	15.0~27.0 10.0~45.0	15.0~27.0 10.0~45.0	15.0~27.0 10.0~45.0	15.0~27.0 10.0~45.0
Sound power level*3			55	55	55	56	57
Connectable indoor units	Total capacity	50 to 150% of O.U. capacity					
	Model/Quantity	P15~P250/2~50		P15~P250/2~50	P15~P250/2~50	P15~P250/2~50	P15~P250/2~50
Ø Ref. piping	Liquid/Gas	mm	28.58/34.93	28.58/34.93	28.58/34.93	28.58/41.28	28.58/41.28
	Flow Rate	m³/h	7.20 + 7.20	7.20 + 7.20	7.20 + 7.20	7.20 + 7.20	7.20 + 7.20
Circulating Water	Operating volume range	4.5+4.5 ~ 11.6+11.6					
	Pressure drop	kPa	44 + 44	44 + 44	44 + 44	44 + 44	44 + 44
	Heat exchanger volume	l	5.0 + 5.0	5.0 + 5.0	5.0 + 5.0	5.0 + 5.0	5.0 + 5.0
	External dimentions	mm	1450 x 880 x 550 1450 x 880 x 550	1450 x 880 x 550 1450 x 880 x 550	1450 x 880 x 550 1450 x 880 x 550	1450 x 880 x 550 1450 x 880 x 550	1450 x 880 x 550 1450 x 880 x 550
Net weight	kg	217+217	217+217	217+217	217+217	217+217	
Ref. Charge R410*/CO ₂ Eq	kg/Tons	6.0+6.0 /25.06	6.0 + 6.0 /25.06	6.0 + 6.0 /25.06	6.0 + 6.0 /25.06	6.0 + 6.0 /25.06	

*1 Nominal cooling conditions: Indoor: 27°C DB / 19°C WB. Water temperature 30°C. Piping length 7.5 m, vertical difference 0 m.

*2 Nominal heating conditions: Indoor 20°C DB. Water temperature 20°C. Piping length 7.5 m, vertical difference 0 m.

*3 Values measured in anechoic chamber.

*4 GWP value of HFC R410A 2088 according to 517 / 2014



BC CONTROLLERS FOR R2 LINES

CMB-M V-J1/V-JA1/V-KB1, CMB-P V-KA1

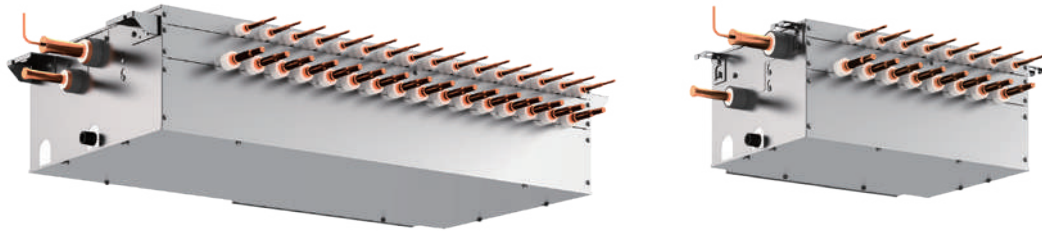

BC Distributors

The new BC distributor of the CMB-P(M)-V-J(1) series effectively distributes the refrigerant depending on the operating mode of the indoor units (heating or cooling). It contains the highly efficient gas/liquid separator developed by Mitsubishi Electric and carefully separates the gas for heating from the cooling liquid. For a greater height difference and an increase in the maximum pipe length, it uses a subcooling heat exchanger that further chills the coolant destined for the indoor units in cooling mode.

New BC controller

Increased number of connections (for systems with BC SUB distributor) and increase of geometric limits. In the R2 heat recovery systems of the new YNW-A1 line it is possible to connect up to 11 BC SUB distributors to the BC MAIN distributor thus allowing greater configuration flexibility. The adoption of the new architecture allows a reduction of the refrigerant charge adopted in the system.

Reduced height

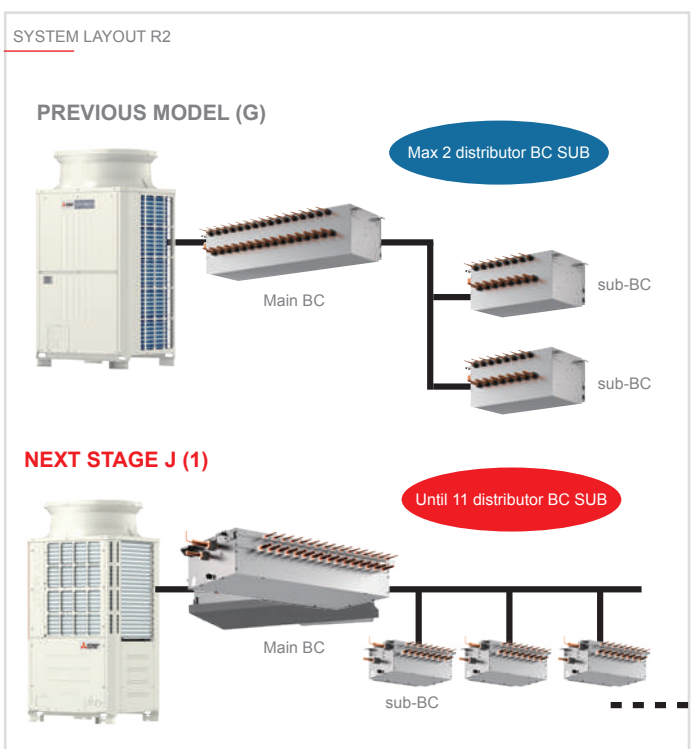
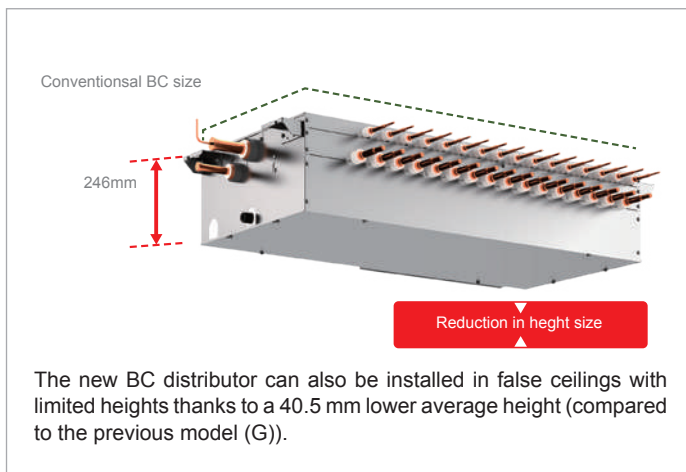

Greater flexibility in system configuration

The maximum length of the refrigeration line between the BC MAIN distributor unit and the indoor unit has been increased to 90 metres* (compared to 60 metres for the previous model) for greater flexibility of system design.

*If the indoor unit is connected to an SUB BC Controller unit

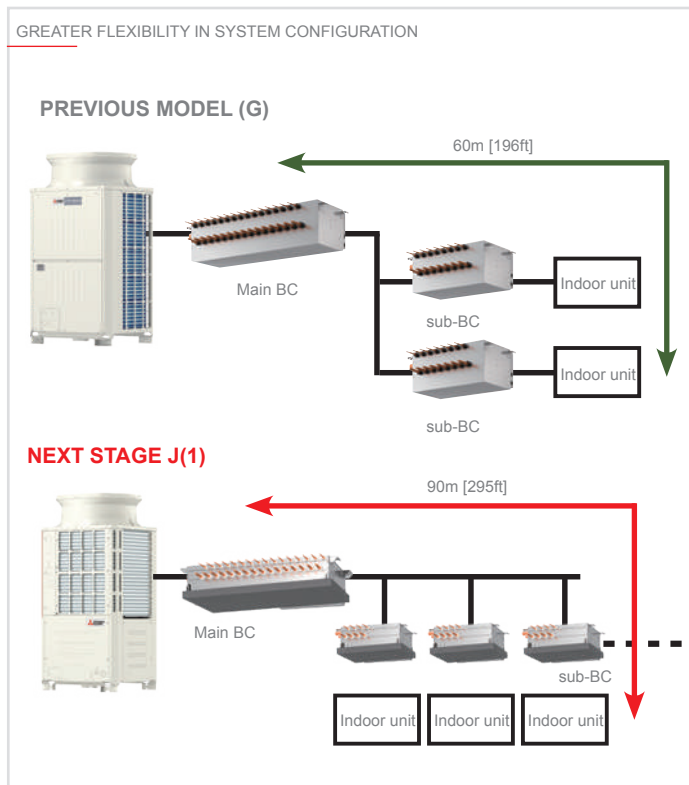

Greater accessibility and ease of maintenance

In the previous model, the drainage panel was on the lower side of the distributor. In the new model it is instead installed on the lower side of the structure, making it easy to remove from the lower part for maintenance access.

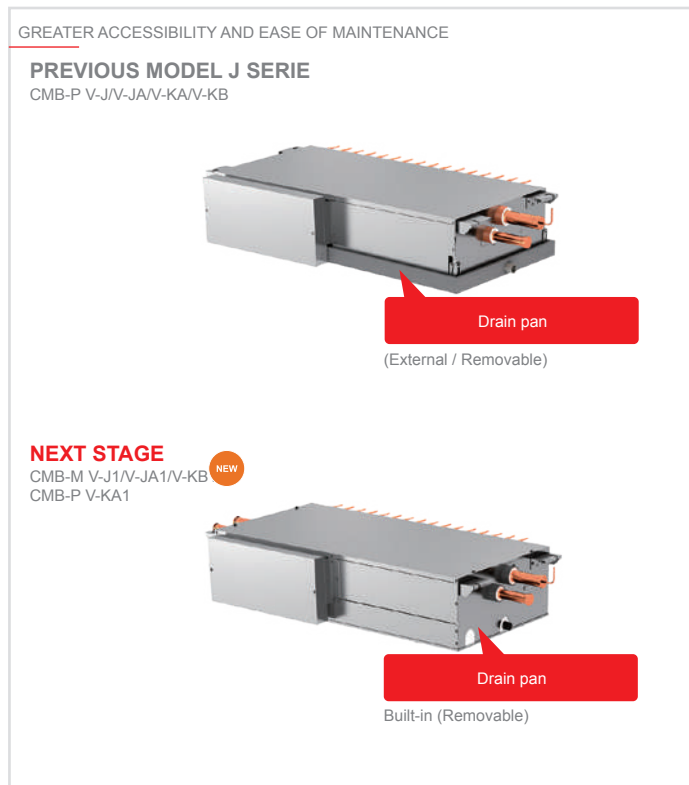

Sub-BC controller connections increased

Only two sub-BC controllers could be connected to a main BC controller in previous models. Up to 11 sub-BC controllers can now be connected to the new BC controller, allowing for more flexibility in system design. The line-branching method enables the creation of system designs that use less refrigerant.

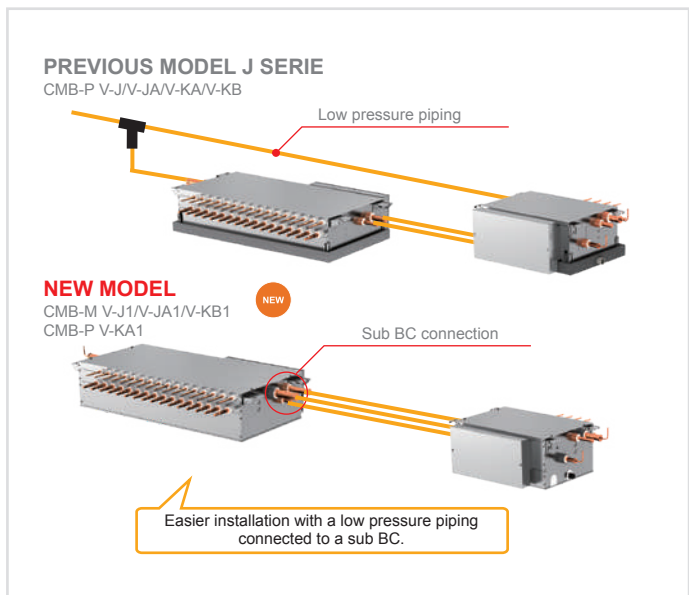

The line-branching method with a main BC controller and sub-BC controllers

The sub-BC controller can be installed near the indoor units, so the branch piping can be greatly reduced. This also reduces the length of system piping, enabling using less refrigerant design.

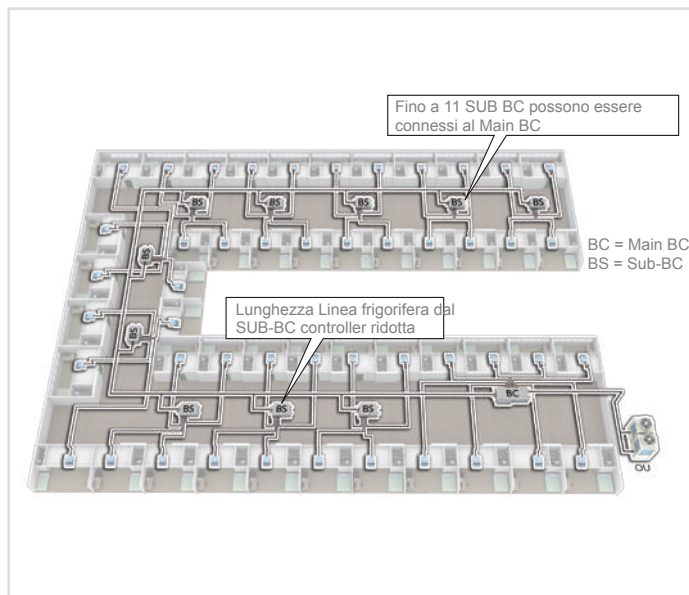

Technical specifications

MODEL Single				CMB-M104V-J1	CMB-M106V-J1	CMB-M108V-J1	CMB-M1012V-J1	CMB-M1016V-J1	
Number of branch				4	6	8	12	16	
Power source				1-phase 220-230-240 V					
Power input	kW	50Hz	Cooling	0.067/0.076/0.085	0.097/0.110/0.123	0.127/0.144/0.161	0.186/0.211/0.236	0.246/0.279/0.312	
			Heating	0.030/0.034/0.038	0.045/0.051/0.057	0.060/0.068/0.076	0.090/0.102/0.114	0.119/0.135/0.151	
Indoor unit capacity connectable to 1 branch				Model P80 or smaller (Use optional joint pipe combing 2 branches when the total unit capacity exceeds P81.)					
Connectable outdoor/heat source unit capacity				P200 to P350					
Height	mm			250	250	250	252	252	
Width	mm			596	596	596	911	1,135	
Depth	mm			476	476	476	622	622	
Refrigerant piping diameter	To outdoor/heat source unit			Connectable unit capacity					
				P200		P250/P300		P350	
	High press. pipe			15.88 (5/8) Brazed		19.05 (3/4) Brazed		19.05 (3/4) Brazed or 22.2 (7/8) Brazed	
	Low press. pipe			19.05 (3/4) Brazed		22.2 (7/8) Brazed		28.58 (1-1/8) Brazed	
	To indoor unit	Liquid pipe			Indoor unit Model 50 or smaller 6.35 (1/4) Brazed bigger than 50 9.52 (3/8) Brazed				
Gas pipe			Indoor unit Model 50 or smaller 12.7 (1/2) Brazed bigger than 50 15.88 (5/8) Brazed (19.05 (3/4), 22.2(7/8) with optional joint pipe used.)						
Drain pipe	mm (in.)			O.D. 32 (1-1/4)	O.D. 32 (1-1/4)	O.D. 32 (1-1/4)	O.D. 32 (1-1/4)	O.D. 32 (1-1/4)	
Net weight	kg (lbs)			26 (58)	29 (64)	33 (73)	49 (109)	59 (131)	

Technical specifications

MODEL Main				CMB-M108V-JA1			CMB-M1012V-JA1			CMB-M1016V-JA1			
Number of branch				8			12			16			
Power source				1-phase 220-230-240 V									
Power input	kW	50Hz	Cooling	0.127/0.144/0.161			0.186/0.211/0.236			0.246/0.279/0.312			
			Heating	0.060/0.068/0.076			0.090/0.102/0.114			0.119/0.135/0.151			
Indoor unit capacity connectable to 1 branch				Model P80 or smaller (Use optional joint pipe combing 2 branches when the total unit capacity exceeds P81.)									
Connectable outdoor/heat source unit capacity				P200 to P900									
Height	mm			252			252			252			
Width	mm			911			1,135			1,135			
Depth	mm			622			622			622			
Refrigerant piping diameter	To outdoor/heat source unit			Connectable unit capacity									
				P200	P250/P300	P350	P400 to P500	P550	P600	P650	P700 to P800	P850 to P900	
	High press. pipe			15.88 (5/8) Brazed	19.05 (3/4) Brazed	19.05 (3/4) Brazed or 22.2 (7/8) Brazed	22.2 (7/8) Brazed	22.2 (7/8) Brazed or 28.58 (1-1/8) Brazed	22.2 (7/8) Brazed or 28.58 (1-1/8) Brazed	28.58 (1-1/8) Brazed	28.58 (1-1/8) Brazed	28.58 (1-1/8) Brazed	
	Low press. pipe			19.05 (3/4) Brazed	22.2 (7/8) Brazed	28.58 (1-1/8) Brazed	28.58 (1-1/8) Brazed	28.58 (1-1/8) Brazed	28.58 (1-1/8) Brazed or 34.93 (1-3/8) Brazed	28.58 (1-1/8) Brazed	34.93 (1-3/8) Brazed	41.28 (1-5/8) Brazed	
	To indoor unit	Liquid pipe			Indoor unit Model 50 or smaller 6.35 (1/4) Brazed bigger than 50 9.52 (3/8) Brazed								
		Gas pipe			Indoor unit Model 50 or smaller 12.7 (1/2) Brazed bigger than 50 15.88 (5/8) Brazed (19.05 (3/4), 22.2 (7/8) with optional joint pipe used.)								
	To other BC controller			Total down-stream Indoor unit capacity									
				to P200	P201 to P300	P301 to P350	P351 to P400	P401 to P600	P601 to P650	P651 to P800	P801 to P1000	P1001 or above	
High press. pipe			15.88 (5/8) Brazed	19.05 (3/4) Brazed	19.05 (3/4) Brazed	22.2 (7/8) Brazed	22.2 (7/8) Brazed	28.58 (1-1/8) Brazed	28.58 (1-1/8) Brazed	28.58 (1-1/8) Brazed	34.93 (1-3/8) Brazed		
Low press. pipe			19.05 (3/4) Brazed	22.2 (7/8) Brazed	28.58 (1-1/8) Brazed	28.58 (1-1/8) Brazed	28.58 (1-1/8) Brazed	28.58 (1-1/8) Brazed	34.93 (1-3/8) Brazed	41.28 (1-5/8) Brazed	41.28 (1-5/8) Brazed		
Liquid pipe			9.52 (3/8) Brazed	9.52 (3/8) Brazed	12.7 (1/2) Brazed	12.7 (1/2) Brazed	15.88 (5/8) Brazed	15.88 (5/8) Brazed	19.05 (3/4) Brazed	19.05 (3/4) Brazed	19.05 (3/4) Brazed		
Drain pipe	mm (in.)			O.D. 32 (1-1/4)			O.D. 32 (1-1/4)			O.D. 32 (1-1/4)			
Net weight	kg (lbs)			48 (106)			60 (133)			68 (150)			

★ Combination chart of BC Controller for R2 series (YNW)

	P200-P350	P400-P900	P950-P1100
CMB-M VJ1	•	N/A	N/A
CMB-M V-JA1	•	•	N/A
CMB-P V-KA1	•	•	•
CMB-M V-KB1 (Sub)	CMB-M108/1012/1016V-JA1, CMB-P1016V-KA1		

Technical specifications

MODEL Main				CMB-P1016V-KA1								
Number of branch				16								
Power source				1-phase 220-230-240 V								
Power input	kW	50Hz	Cooling	0.246/0.279/0.312								
			Heating	0.119/0.135/0.151								
Indoor unit capacity connectable to 1 branch				Model P80 or smaller (Use optional joint pipe combing 2 branches when the total unit capacity exceeds P81.)								
The maximum number of connectable Sub BC controllers				-								
The maximum connectable capacity of indoor units				-								
Connectable outdoor/heat source unit capacity				P200 to P1100								
Connectable Main BC controller				-								
Height	mm			250								
Width	mm			1,135								
Depth	mm			622								
Refrigerant piping diameter	To outdoor/heat source unit			Connectable unit capacity								
				P200	P250/P300	P350	P400 to P500	P550	P600	P650	P700 to P800	P850 to P1000
	High press. pipe			15.88 (5/8) Braze	19.05 (3/4) Braze	19.05 (3/4) Braze or 22.2 (7/8) Braze	22.2 (7/8) Braze	22.2 (7/8) Braze or 28.58 (1-1/8) Braze	22.2 (7/8) Braze or 28.58 (1-1/8) Braze	28.58 (1-1/8) Braze	28.58 (1-1/8) Braze	28.58 (1-1/8) Braze
	Low press. pipe			19.05 (3/4) Braze	22.2 (7/8) Braze	28.58 (1-1/8) Braze	28.58 (1-1/8) Braze	28.58 (1-1/8) Braze	28.58 (1-1/8) Braze or 34.93 (1-3/8) Braze	28.58 (1-1/8) Braze	34.93 (1-3/8) Braze	41.28(1-5/8) Braze
	To indoor unit	Liquid pipe		Indoor unit Model 50 or smaller 6.35 (1/4) Braze bigger than 50 9.52 (3/8) Braze								
		Gas pipe		Indoor unit Model 50 or smaller 12.7 (1/2) Braze bigger than 50 15.88 (5/8) Braze (19.05 (3/4), 22.2 (7/8) with optional joint pipe used.)								
	To other BC controller			Total down-stream Indoor unit capacity								
				to P200	P201 to P300	P301 to P350	P351 to P400	P401 to P600	P601 to P650	P651 to P800	P801 to P1000	P1001 or above
	High press. pipe			15.88 (5/8) Braze	19.05 (3/4) Braze	19.05 (3/4) Braze	22.2 (7/8) Braze	22.2 (7/8) Braze	28.58 (1-1/8) Braze	28.58 (1-1/8) Braze	28.58 (1-1/8) Braze	34.93 (1-3/8) Braze
	Low press. pipe			19.05 (3/4) Braze	22.2 (7/8) Braze	28.58 (1-1/8) Braze	28.58 (1-1/8) Braze	28.58 (1-1/8) Braze	28.58 (1-1/8) Braze	34.93 (1-3/8) Braze	41.28(1-5/8) Braze	41.28(1-5/8) Braze
Liquid pipe			9.52 (3/8) Braze	9.52 (3/8) Braze	12.7 (1/2) Braze	12.7 (1/2) Braze	15.88 (5/8) Braze	15.88 (5/8) Braze	19.05 (3/4) Braze	19.05 (3/4) Braze	19.05 (3/4) Braze	
Drain pipe	mm (in.)			O.D. 32 (1-1/4)								
Net weight	kg (lbs)			69 (153)								

Technical specifications

MODEL Sub				CMB-M104V-KB1										
Number of branch				4										
Power source				1-phase 220-230-240 V										
Power input	kW	50Hz	Cooling	0.060/0.068/0.076										
			Heating	0.030/0.034/0.038										
The maximum number of connectable Sub BC controllers				11										
The maximum connectable capacity of indoor units				P350 for each										
Connectable Main BC controller				CMB-M108/1012/1016V-JA1, CMB-P1016V-KA1										
Height	mm			250										
Width	mm			596										
Depth	mm			476										
Refrigerant piping diameter	To outdoor/heat source unit			-										
	High press. pipe			-										
	Low press. pipe			-										
	To indoor unit	Liquid pipe			Indoor unit Model 50 or smaller 6.35 (1/4) Brazed bigger than 50 9.52 (3/8) Brazed									
		Gas pipe			Indoor unit Model 50 or smaller 12.7 (1/2) Brazed bigger than 50 15.88 (5/8) Brazed (19.05 (3/4) with optional joint pipe used.)									
	To other BC controller			Total down-stream Indoor unit capacity										
				to P200	P201 to P300	P301 to P350	P351 to P400	P401 to P600	P601 to P650	P651 to P800	P801 to P1000	P1001 or above		
	High press. pipe			15.88 (5/8) Brazed	19.05 (3/4) Brazed	19.05 (3/4) Brazed	22.2 (7/8) Brazed	22.2 (7/8) Brazed	28.58 (1-1/8) Brazed	28.58 (1-1/8) Brazed	28.58 (1-1/8) Brazed	34.93 (1-3/8) Brazed		
	Low press. pipe			19.05 (3/4) Brazed	22.2 (7/8) Brazed	28.58 (1-1/8) Brazed	28.58 (1-1/8) Brazed	28.58 (1-1/8) Brazed	28.58 (1-1/8) Brazed	34.93 (1-3/8) Brazed	41.28(1-5/8) Brazed	41.28(1-5/8) Brazed		
	Liquid pipe			9.52 (3/8) Brazed	9.52 (3/8) Brazed	12.7 (1/2) Brazed	12.7 (1/2) Brazed	15.88 (5/8) Brazed	15.88 (5/8) Brazed	19.05 (3/4) Brazed	19.05 (3/4) Brazed	19.05 (3/4) Brazed		
Drain pipe	mm (in.)			O.D. 32 (1-1/4)										
Net weight	kg (lbs)			23 (51)										

Technical specifications

MODEL Sub				CMB-M108V-KB1										
Number of branch				8										
Power source				1-phase 220-230-240 V										
Power input	kW	50Hz	Cooling	0.119/0.135/0.151										
			Heating	0.060/0.068/0.076										
The maximum number of connectable Sub BC controllers				11										
The maximum connectable capacity of indoor units				P350 for each										
Connectable Main BC controller				CMB-M108/1012/1016V-JA1, CMB-P1016V-KA1										
Height	mm			246										
Width	mm			596										
Depth	mm			495										
Refrigerant piping diameter	To outdoor/heat source unit			-										
	High press. pipe			-										
	Low press. pipe			-										
	To indoor unit	Liquid pipe			Indoor unit Model 50 or smaller 6.35 (1/4) Brazed bigger than 50 9.52 (3/8) Brazed									
		Gas pipe			Gas pipe Indoor unit Model 50 or smaller 12.7 (1/2) Brazed bigger than 50 15.88 (5/8) Brazed(19.05 (3/4) with optional joint pipe used.)									
	To other BC controller			Total down-stream Indoor unit capacity										
				to P200	P201 to P300	P301 to P350	P351 to P400	P401 to P600	P601 to P650	P651 to P800	P801 to P1000	P1001 or above		
	High press. pipe			15.88	19.05	19.05	22.2	22.2	28.58	28.58	28.58	34.93		
	Low press. pipe			19.05	22.2	28.58	28.58	28.58	28.58	34.93	41.28	41.28		
	Liquid pipe			9.52	9.52	12.7	12.7	15.88	15.88	19.05	19.05	19.05		
Drain pipe	mm (in.)			O.D. 32 (1-1/4)										
Net weight	kg (lbs)			31 (69)										



Model code

CITY MULTI outdoor units

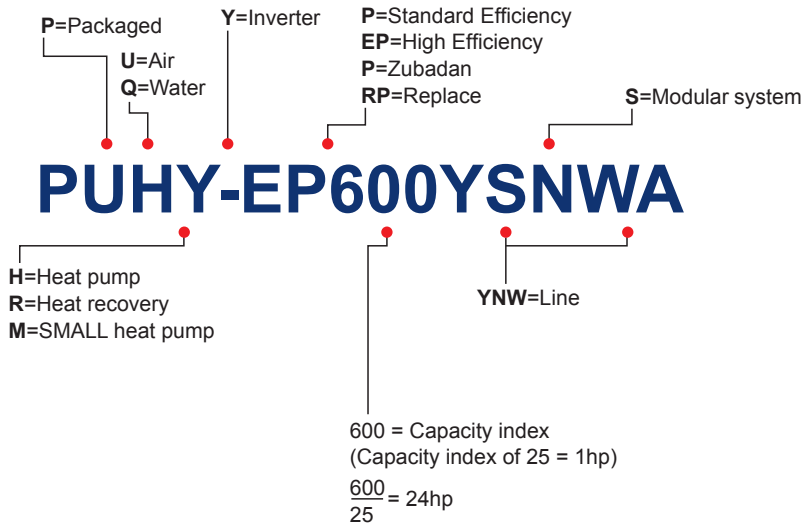

CITY MULTI indoor units

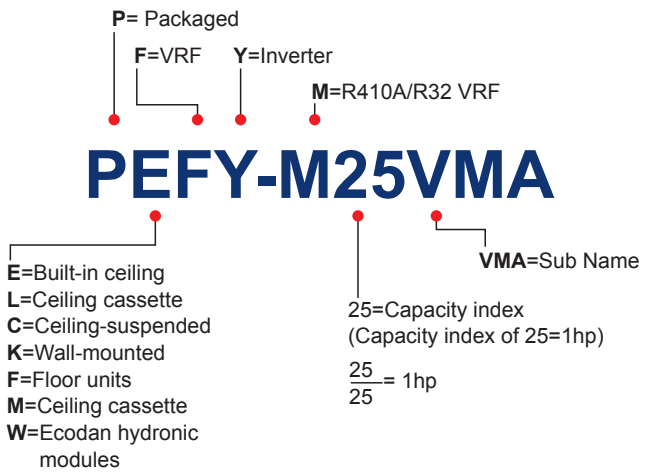

BC Controller

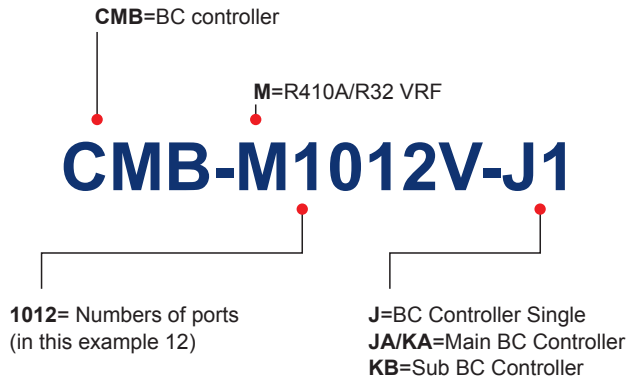



Refrigerant piping lenght

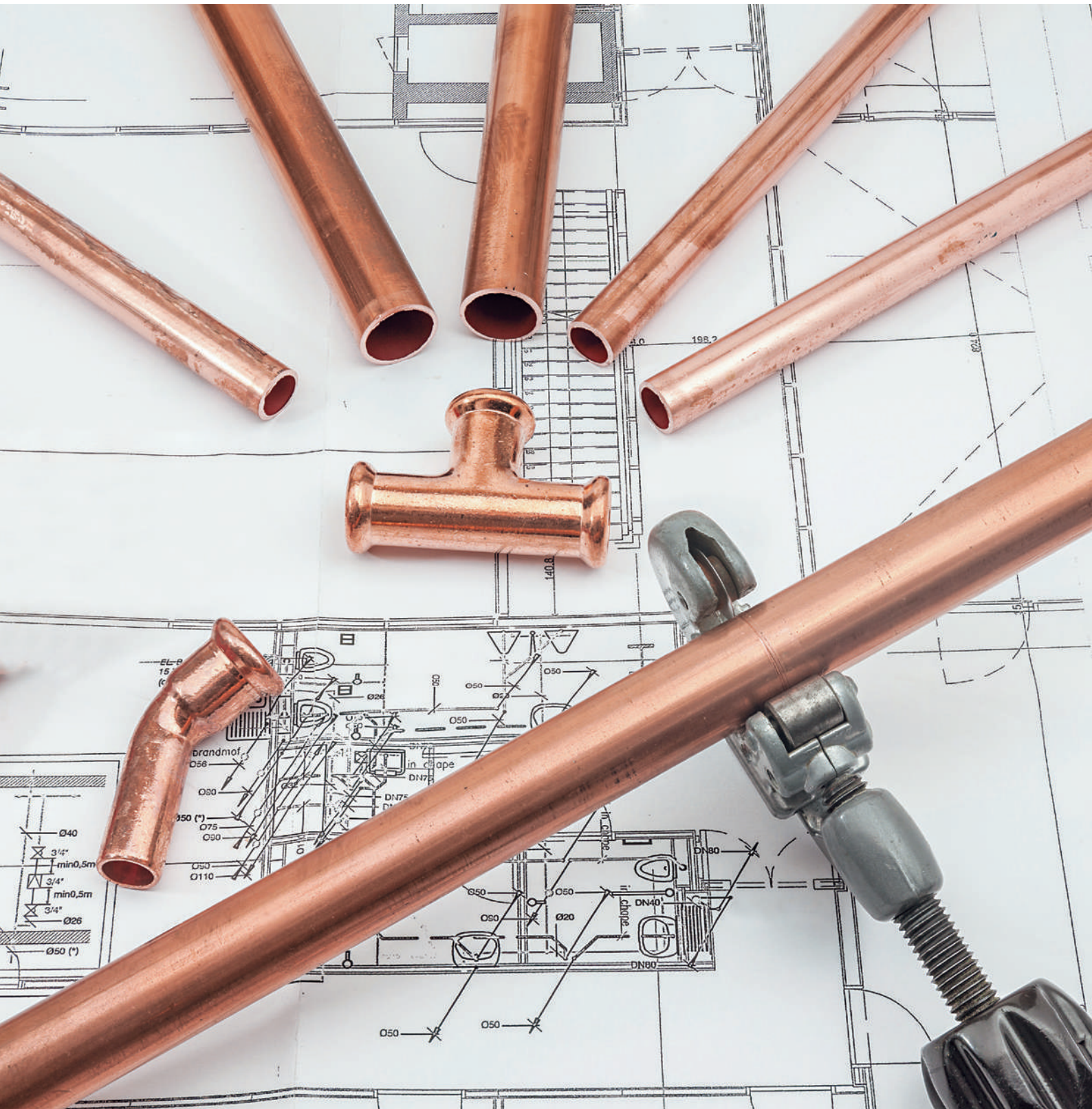

PUMY-SP112~140 Y(V)KM2

SMALL Y COMPACT LINE

GEOMETRIC LIMITS OF REFRIGERATION PIPELINES	
Total effective length	120 m max.
Effective length of a single circuit	70 m (90 m equivalent) max.
Effective length after first branch	50 m max.

VERTICAL DIFFERENCE BETWEEN UNITS	
Indoor/outdoor (outdoor unit in higher position)	50 m max.
Indoor/outdoor (indoor unit in higher position)	30 m max.
Indoor/Indoor	15 m max.

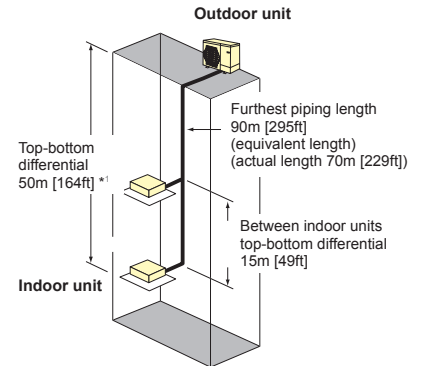

PUMY-P112~140 Y(V)KM5(6)

SMALL Y LINE

GEOMETRIC LIMITS OF REFRIGERATION PIPELINES	
Total effective length	300 m max.
Effective length of a single circuit	150 m (175 m equivalent) max.
Effective length after first branch	30 m max.

VERTICAL DIFFERENCE BETWEEN UNITS	
Indoor/outdoor (outdoor unit in higher position)	50 m max.
Indoor/outdoor (indoor unit in higher position)	40 m max.
Indoor/Indoor	15 m max.

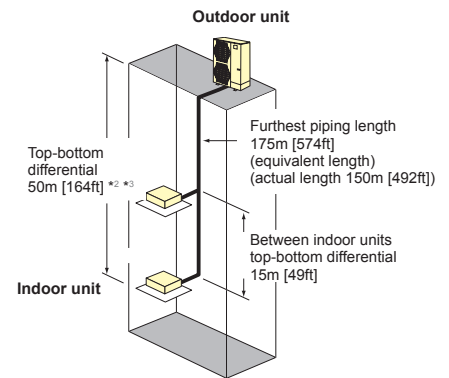

PUMY-P200 YKM3

SMALL Y (HIGH CAPACITY) LINE

GEOMETRIC LIMITS OF REFRIGERATION PIPELINES	
Total effective length	150 m max.
Effective length of a single circuit	80 m (90 m equivalent) max.
Effective length after first branch	30 m max.

VERTICAL DIFFERENCE BETWEEN UNITS	
Indoor/outdoor (outdoor unit in higher position)	50 m max.
Indoor/outdoor (indoor unit in higher position)	40 m max.
Indoor/Indoor	15 m max.

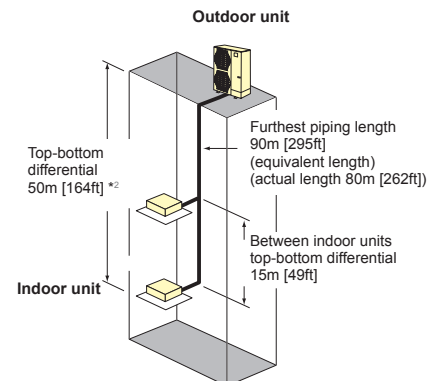

Indicative values only – See technical handbook for installation details.

*1 When the outdoor unit is installed below the indoor unit, top-bottom differential is 30m [98ft].

*2 When the outdoor unit is installed below the indoor unit, top-bottom differential is 40m [131ft].

*3 30m [98ft] or less if PKFY-P10/15/20/25/32/VLM, PFFY-P*VKM, PFFY-P*VCM, PFFY-P*VL* type of indoor units are included.

PUMY-P250/300 YBM2

SMALL Y (HIGH CAPACITY) LINE

GEOMETRIC LIMITS OF REFRIGERATION PIPELINES	
Total effective length	310 m max.
Effective length of a single circuit	150 m (175 m equivalent) max.
Effective length after first branch	30 m max.

VERTICAL DIFFERENCE BETWEEN UNITS	
Indoor/outdoor (outdoor unit in higher position)	50 m max.
Indoor/outdoor (indoor unit in higher position)	40 m max.
Indoor/Indoor	15 m max.

Indicative values only – See technical handbook for installation details.

*2 When the outdoor unit is installed below the indoor unit, top-bottom differential is 40m [131ft].

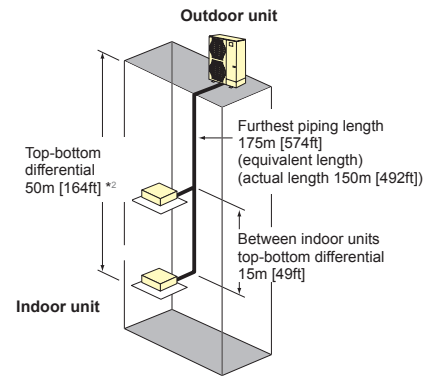

PUHY-P200-1350Y(S)NW-A2

PUHY-EP200-1350Y(S)NW-A2

Y NEXT STAGE LINE

Y NEXT STAGE HIGH EFFICIENCY LINE

GEOMETRIC PIPING LIMITATIONS WITH ONE OR MORE BC CONTROLLERS	
Total effective length	1000 m max.
Effective length of a single circuit	165 m max.
Equivalent length of a single circuit	190 m max.
Effective length after first branch	90 m max.

VERTICAL DIFFERENCE BETWEEN UNITS	
Indoor/outdoor (outdoor unit in higher position)	50 m max.
Indoor/outdoor (indoor unit in higher position)	40 m max.
Indoor/Indoor	30 m max.

Indicative values only – See technical handbook for installation details.

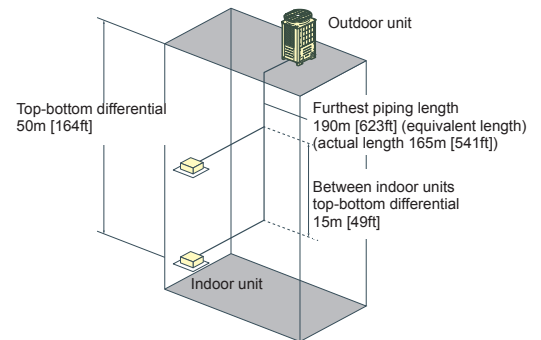

PUHY-HP200-500Y(S)NW-A

Y ZUBADAN LINE

GEOMETRIC LIMITS OF REFRIGERATION PIPELINES	
Total effective length	1000 m max.
Effective length of a single circuit	165 m (190 m equivalent) max.
Effective length after first branch	40 m max.

VERTICAL DIFFERENCE BETWEEN UNITS	
Indoor/outdoor (outdoor unit in higher position)	50 m max.
Indoor/outdoor (indoor unit in higher position)	40 m max.
Indoor/Indoor	15 m max.

Indicative values only – See technical handbook for installation details.

*1 90m is available. When the piping length exceeds 40m, use one size larger liquid pipe starting with the section of piping where 40m is exceeded and all piping after that point.

*2 90m is available depending on installation conditions. For more detailed information, contact your local distributor.

*3 60m is available depending on installation conditions. For more detailed information, contact your local distributor.

*4 30m is available. If the height difference between indoor units exceeds 15m (but does not exceed 30m), use one size larger pipes for indoor unit liquid pipes.

*5 When the outdoor unit is installed below the indoor unit, top-bottom differential is 40m.

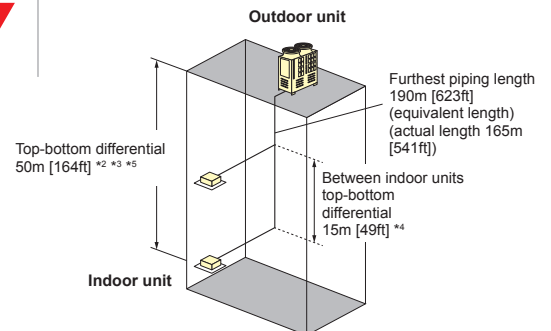

PURY-P200-1100Y(S)NW-A2

PURY-EP200-1100Y(S)NW-A2

R2 NEXT STAGE LINE
R2 NEXT STAGE HIGH EFFICIENCY LINE

GEOMETRIC PIPING LIMITATIONS WITH ONE OR MORE BC CONTROLLERS	
Total effective length	500-1000 m max.
Effective length of a single circuit	165 m max.
Equivalent length of a single circuit	190 m max.
Effective length between outdoor unit and BC controller	110 m max.
Effective length between BC controller and indoor unit	60 m max.

VERTICAL DIFFERENCE BETWEEN UNITS	
Indoor/outdoor (outdoor unit in higher position)	50 m max.
Indoor/outdoor (indoor unit in higher position)	40 m max.
Indoor/BC Controller	15 m max.
Indoor/Indoor	30 m max.
Effective length between outdoor unit and BC controller	15 m max.

Indicative values only – See technical handbook for installation details.

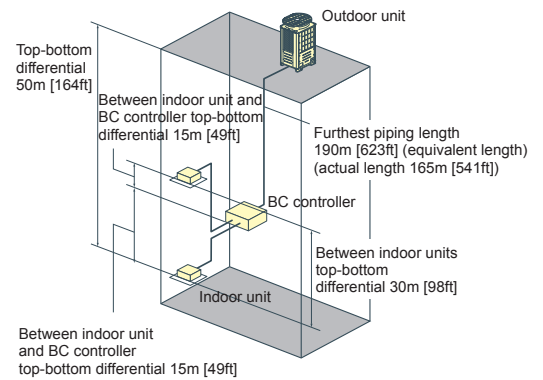

PQHY-P200-900Y(S)LM-A1

WY LINE

GEOMETRIC LIMITS OF REFRIGERATION PIPELINES	
Total effective length	300-500 m max.
Effective length of a single circuit	165 m max.
Equivalent length of a single circuit	190 m max.
Effective length after first branch	40 m max.

VERTICAL DIFFERENCE BETWEEN UNITS	
Indoor/outdoor (outdoor unit in higher position)	50 m max.
Indoor/outdoor (indoor unit in higher position)	40 m max.
Indoor/Indoor	15 m max.

Indicative values only – See technical handbook for installation details.
*500 m max per PQHY-P350-600YLM

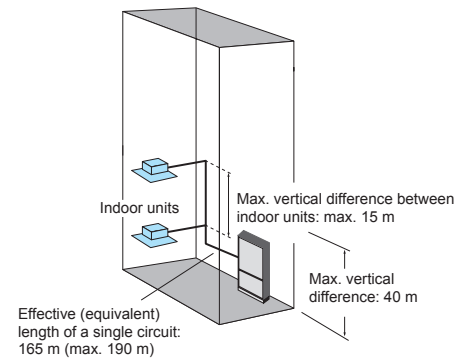

PQRY-P200~900Y(S)LM-A1

WR2 LINE

GEOMETRIC PIPING LIMITATIONS WITH ONE OR MORE BC CONTROLLERS	
Total effective length	300-750 m max.
Effective length of a single circuit	165 m max.
Equivalent length of a single circuit	190 m max.
Effective length between outdoor unit and BC controller	110 m max.
Effective length between BC controller and indoor unit	40-60 m max.

VERTICAL DIFFERENCE BETWEEN UNITS	
Indoor/outdoor (outdoor unit in higher position)	50 m max.
Indoor/outdoor (indoor unit in higher position)	40 m max.
Indoor/BC Controller	15 m max.
Indoor/Indoor	30 m max.
BC Controller and SUB BC Controller	15 m max.

Indicative values only – See technical handbook for installation details.

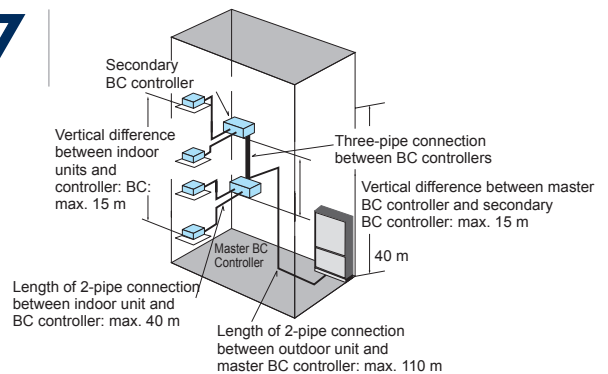

VRF Systems

Indoor units

Ceiling cassette

PLFY-P VFM-E1 4-way cassette 600x600	114
PLFY-M VEM6-E 4 way cassette 900x900	116
PLFY-P VLMD-E 2 way cassette	122
PMFY-P VBM-E 1 way cassette	126

Ceiling concealed

PEFY-P VMS1-E Medium to low static pressure	128
PEFY-M VMA-A1 Medium to high static pressure	130
PEFY-P VMHS-E High static pressure	134
PEFY-P VMHS-E High static pressure	136

Ceiling suspended

PCFY-P VKM-E	138
--------------	-----

Wall mounted

PKFY-P VLM-E	140
PKFY-P VKM-E	142
PAC-LV11-E Wall mounted design indoor unit LEV-KIT	144



Floor standing

PFFY-P VKM-E Design unit	146
PFFY-P VEM-E Freestanding	NEW 148
PFFY-P VCM-E Concealed type	152

Type		Model		P10	P15	P20	P25	P32		
				1.2 kW ¹	1.7 kW ¹	2.2 kW ¹	2.8 kW ¹	3.6 kW ¹		
Ceiling cassette	4 way flow	PLFY-P VFM-E1			•	•	•	•		
		PLFY-M VEM6-E				•	•	•		
	2 way cassette	PLFY-P VLMD-E				•	•	•		
	1 way cassette	PMFY-P VBM-E				•	•	•		
Ceiling concealed indoor units	Middle-high static pressure	PEFY-P VMS1-E			•	•	•	•		
	Middle-high static pressure	PEFY-M VMA-A1				•	•	•		
	High static pressure	PEFY-P VMHS-E								
	High static pressure	PEFY-P VMHS-E								
Ceiling Suspended indoor units		PCFY-P VKM-E								
Wall mounted indoor units		PKFY-P VLM		•	•	•	•	•		
		PKFY-P VKM								
	Wall mounted design with LEV-KIT	LEV KIT MSZ-EF			•	•	•	•	•	
		LEV KIT MSZ-LN					•	•	•	
Floor standing indoor units		PFFY-P VKM-E				•	•	•		
		PFFY-P VEM-E				•	•	•		
	Concealed type	PFFY-P VCM-E				•	•	•		

¹Nominal cooling capacity

	P40	P50	P63	P71	P80	P100	P125	P140	P200	P250
	4.5 kW ⁻¹	5.6 kW ⁻¹	7.1 kW ⁻¹	8.0 kW ⁻¹	9.0 kW ⁻¹	11.2 kW ⁻¹	14.0 kW ⁻¹	16.0 kW ⁻¹	22.4 kW ⁻¹	28.0 kW ⁻¹
	.	.								
			
				
	.									
	.	.								
		
									.	.
			
	.	.								
			.			.				
	.	.								
		.								
	.									
	.	.	.							
	.	.	.							



Key Technologies

Mitsubishi Electric innovation allowed the development of functions and technologies at the service of comfort and energy efficiency.

Style



“Pure white” colour

This is the colour adopted by Mitsubishi Electric for many of its indoor units. It is a colour suitable for virtually all interior spaces.



Automatic vane

The vane adjusts automatically to the optimum angle in relation to operating mode and output air temperature.

Functions



Timer

Annual, weekly, daily or simplified timer functions may be used to switch the unit on and off as desired.

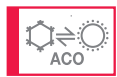

Automatic mode switching

The indoor unit automatically (AUTO) switches operating mode (COOL/HEAT) in relation to the temperature setting.



Ultra silent

These indoor units produce extraordinarily low sound pressure levels.

Air quality



Deodorizing filter

The bad smells present in the environment are captured from the deodorizing filter and then be eliminated by the technology plasma. Extremely low deodorization time makes this function even more effective against the odors of animals or of cooking.



Outdoor air intake

The air quality in the indoor space may be improved using the outdoor fresh air intake.

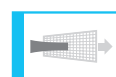

Standard filter

A honeycomb or synthetic fibre filter with high dust holding capacity.



Long-life filter

The special surface of the long-life filter requires less maintenance than a conventional filter.



“Dirty filters” indicator signal

Filter usage is monitored to indicate when maintenance is necessary.



Air purifying filter

The filter has a large capture area and deodorise the circulating air.

Air distribution



Vane positions

Number of possible positions for the air deflector vane.



Swing vane

A continuous swinging motion of the vane ensures that air is distributed ideally throughout the room.



Fan speed

Number of fan speeds available.



Automatic fan

The fan speed is automatically adjusted to meet the desired level of comfort



High ceiling

For installations on high ceilings, the air flow may be augmented to improve air distribution.



Low ceiling

For installations on low ceilings, the air flow may be reduced to prevent unpleasant draughts.



Air intake on underside

As an option during installation, the unit may be configured with the air intake on the underside.

Installation and maintenance



Condensate drain pump

The condensate drain pump facilitates installation.



Self-diagnostic

A self-diagnostic system makes troubleshooting and correcting malfunctions easier by recording a log of faults.

Special functions



Auto-restart

The auto restart function may be used to configure the indoor units to restart automatically after a power outage, minimising interruptions in the operation of the system to maintain thermal comfort levels in the air conditioned spaces. This function must be enabled as an option as it is not enabled by default. A choice of two automatic start configurations is available:

- restart only the indoor units which were on before the power outage;
- restart all indoor units, irrespective of on/off state before the power outage.



Stratification compensation

The automatic heat stratification compensation function in HEAT mode is implemented by adjusting the ambient temperature read by a probe on the indoor unit, to obtain a value that more closely reflects the true temperature of the air conditioned space.

An offset of -4°C is applied, so that, for instance, if the inlet temperature measured is 24°C, the system automatically displays an adjusted value of 20°C, which should more closely reflect the true ambient temperature. The Mitsubishi Electric CITY MULTI VRF system bases the thermal power actually delivered on this value.

The stratification compensation function is available on all Mitsubishi Electric indoor unit types with the exception of floor-standing units and certain specific cases (such as with units with underside air intakes), and may be disabled on request.

































Low temperature cooling









This function extends the operating temperature range in cooling mode to offer a lowest settable temperature of 14°C. Where the ability to cool to temperatures lower than the standard lowest comfort value of 19°C (typically for sports centres, laboratories etc.) is necessary, the settable temperature range in cooling mode may be extended to offer a lowest temperature of 14°C.

Contact your local distributor for more details on the types of compatible Indoor units.

The indoor unit fan is run at a higher speed in this configuration (except with the SMALL Y model outdoor unit of the PUMY series).

		Cassette						
								
		PLFY-P VFM-E1	PLFY-M VEM6-E	PLFY-P VLMD-E	PMFY-P VBM-E	PEFY-P VMS1-E	PEFY-M VMA-A1	PEFY-P VMHS-E
Style		•	•	•	•			
		•	•	•	•			
Functions		•	•		•	•	•	•
		•	•	•	•	•	•	•
		•	•	•		•		
Air quality		•	•	•				
			•		•			
		•	•	•				
								
		•	•	•	•			
								
								
Air distribution		5	5	4	4			
		•	•	•	•			
		3	4	3 4(P125)	4	3	3	2
		•	•			•		
		•	•					
		•	•					
							•	
Install. and mainten.		•	•	•	•	•*	•	•*
		•	•	•	•	•	•	•
Special functions		•	•	•	•	•	•	•
		•	•		•	•	•	•
		**	**	**	**	**	**	**

* Optional
 ** Please contact your local distributor for compatibility

							Floor standing	
								
PEFY-P VMHS-E	PCFY-P VKM-E	PKFY-P VKM-E	PKFY-P VLM	LEV KIT MSZ-EF	LEV KIT MSZ-LN	PFFY-P VEM-E	PFFY-P VCM-E	
	•	•	•			•		
	•	•	•	•	•			
•	•	•	•	•	•	•	•	
•	•	•	•	•	•	•	•	
				•	•			
	•							
		•	•	•		•	•	
	•							
	•	•	•	•			•	
					•			
	5	4	5	5	5			
	•	•	•	•	•			
3	4	2	4	5	5	3	3	
•	•			•	•			
	•							
	•							
•*								
•	•	•	•	•	•			
•	•	•	•	•	•	•	•	
•	•	•	•	•	•			
**	**	**	**	**	**	**	**	

PLFY-P VFM-E1

INDOOR UNITS - 4-way cassette 600x600



CITY MULTI

Ideal for...

The **straight-line shape** introduced has resulted in a stylish and modern square design. Its high affinity ensures the ability to blend in seamlessly with any interior. The indoor unit is an ideal match for office or store use.



3D i-see Sensor

New advanced 3D i-see sensor detects people's position and number. Once a person is detected, the angle of the vane is automatically adjusted. Each vane can be independently set to "Direct Airflow" or "Indirect Airflow" according to taste.

The 3D i-see Sensor detects the number of people in the room and adjusts the power accordingly. This makes automatic power-saving operation possible in places where the number of people changes frequently.

Additionally, when the area is continuously unoccupied, the system switches to a more enhanced power-saving mode. Depending on the setting, it can also stop the operation.

Horizontal flow

The new airflow control completely eliminates that uncomfortable drafty-feeling with the introduction of a **horizontal airflow** that spreads across the ceiling, maximizing the Coanda effect. Furthermore, 5 patterns for vane position (on previous VCM was 4) and individual settable vane and ways ensure higher comfort. The ideal airflow for offices and restaurants.

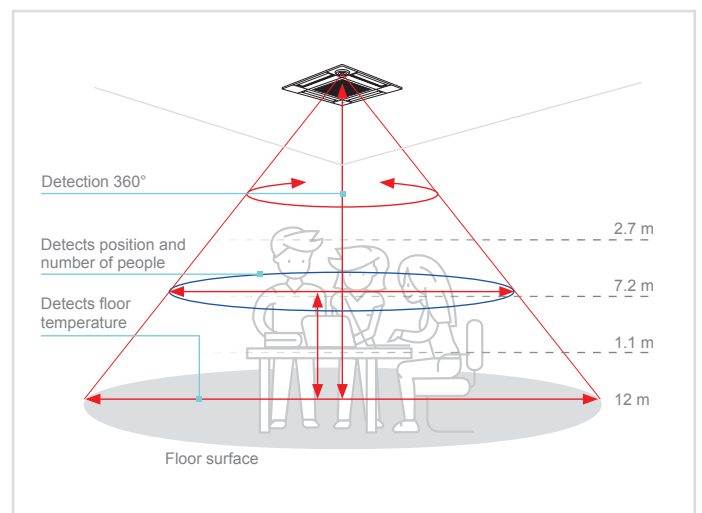
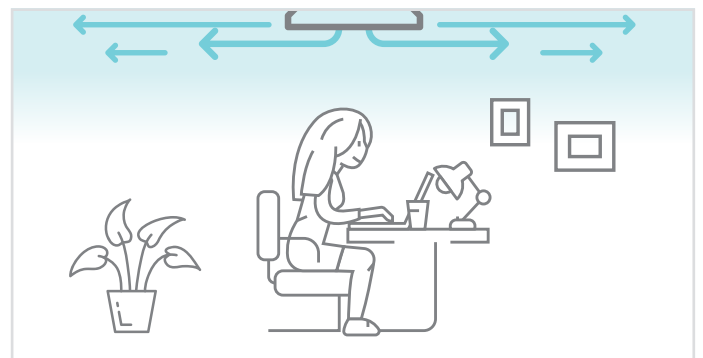

Simplified installation

The height above ceiling of 245 mm is top class in the industry. The height above ceiling of 245 mm enables fitting into narrow ceiling space. Installation is simple, even when the ceiling spaces are narrow to make the ceilings higher. Light weight (max 15kg) and temporary hanging hooks for grille allow to make installation easier and quicker.

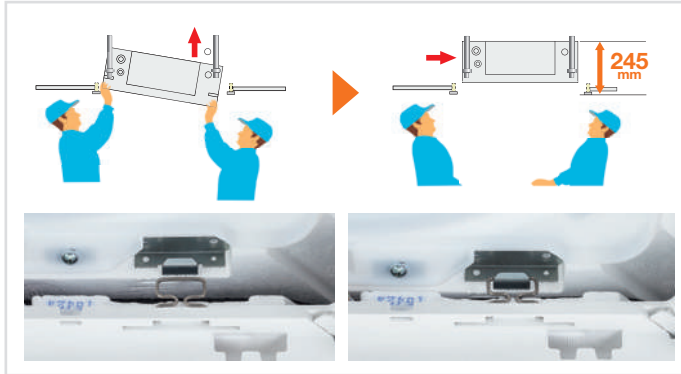

Panel and control

The unit is supplied with SLP-2FAL panel which includes signal receiver. Is available as optional the SLP-2FALM panel combined with the new PAR-SL101A-E wireless remote control with weekly timer, backlight, temperature setting in 0.5 °C steps and individual control of the 4 deflectors.

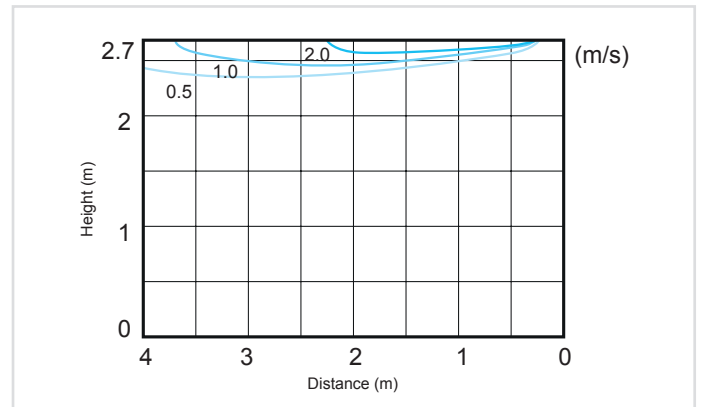

Key Technologies

Technical specifications

MODEL			PLFY-P15VFM-E1	PLFY-P20VFM-E1	PLFY-P25VFM-E1	PLFY-P32VFM-E1	PLFY-P40VFM-E1	PLFY-P50VFM-E1	
Default panel			SLP-2FAL						
Power			Single phase, 220-240V 50Hz						
Capacity in cooling mode*1		kW	1.7	2.2	2.8	3.6	4.5	5.6	
		Btu/h	5800	7500	9600	12300	15400	19100	
Capacity in heating mode*1		kW	1.9	2.5	3.2	4	5	6.3	
		Btu/h	6500	8500	10900	13600	17100	21500	
Power consumption	Cooling	kW	0.02	0.02	0.02	0.02	0.03	0.04	
	Heating	kW	0.02	0.02	0.02	0.02	0.03	0.04	
Current	Cooling	A	0.19	0.21	0.22	0.23	0.28	0.4	
	Heating	A	0.14	0.16	0.17	0.18	0.23	0.35	
External finish	Unit		Galvanised steel sheet with uncoated thermal insulation						
	Grille		Pure White						
Dimensions A x L x P	Unit	mm	245x570x570	245x570x570	245x570x570	245x570x570	245x570x570	245x570x570	
	Grille	mm	10x625x625	10x625x625	10x625x625	10x625x625	10x625x625	10x625x625	
Net weight	Unit	kg	14	14	14	15	15	15	
	Grille	kg	3	3	3	3	3	3	
Heat exchanger			Cross fins						
Fan	Type x Quantity		3D Turbo fan x 1						
	Air flow*2	m³/min	6.5 - 7.5 - 8	6.5 - 7.5 - 8.5	6.5 - 8 - 9	7 - 8 - 9.5	7.5 - 9 - 11	9 - 11 - 13	
	Ext. Static pressure	Pa	0	0	0	0	0	0	
Air filter			Polypropylen honeycomb (long life)						
Refrigerant pipe diameter	Gas (swaged)	mm	12.7	12.7	12.7	12.7	12.7	12.7	
	Liquid (swaged)	mm	6.35	6.35	6.35	6.35	6.35	6.35	
Sound pressure*2*3			dB(A)	26 - 28 - 30	26 - 29 - 31	26 - 30 - 33	26 - 30 - 34	28 - 33 - 39	33 - 39 - 43

* Default panel. SLP-2FAL panel is equipped by Signal receiver

*1 For heating/cooling capacity, the maximum value with the unit operating in the following conditions is given.

Cooling: indoor 27°C (81°F) DB/19°C (66°F) WB, outdoor 35°C (95°F) DB. Heating: indoor 20°C (68°F) DB, outdoor 7°C (45°F) DB/6°C (43°F) WB.

*2 Air flow/noise levels given for operation in low-medium-high modes.

*3 Measured in anechoic chamber with 230V mains power.

Optional parts	DESCRIPTION
PAC-SF1ME-E	Corner 3D I-see Sensor for PLFY-P VFM-E1

PLFY-M VEM6-E

INDOOR UNITS - 4-way cassette 900x900



CITY MULTI

Ideal for...

New design of 4-way cassette VEM model suits most commercial applications thanks to its elegance and style. Its peculiar features are horizontal flow function, individually settable vanes and possibility to install 3D i-see sensor for top environment comfort control.

3D i-see sensor: Temperature sensor

3D i-see sensor is able to detect temperature distribution inside the room, making it possible to direct airflow to those areas which generally receive less air, making them more uncomfortable (too cold or too hot) for users.



Horizontal flow

This new indoor unit is capable of handling five vane positions, making it possible to achieve horizontal flow that spreads across the ceiling, maximizing the Coanda effect. This allows to avoid, if needed, direct airflow to users in the room, which can sometimes be uncomfortable.

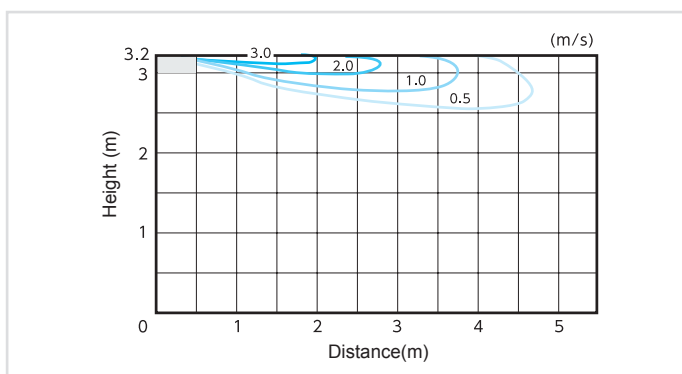



Key Technologies

3D i-see sensor: Direct/Indirect flow function

Optional 3D i-see sensor allows to detect and count users in the environment and their position. User can set either Direct or Indirect flow to occupied areas, with single control on four vanes.



3D i-see sensor: Energy saving

3D i-see sensor features allow to optimize comfort conditions and at the same time achieve energy saving. Thanks to the occupancy sensor the unit is able to automatically handle and reduce power output accordingly to users actually being present in the room or in certain areas of it. This feature is particularly helpful in those environments in which occupancy varies significantly during the day.

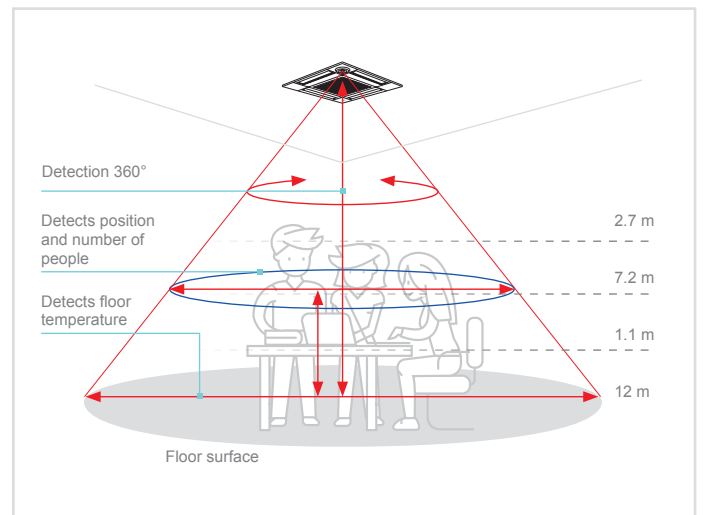

Optimum airflow

2-, 3-, 4-way airflow pattern selection

Three outlet options are available--bidirectional, three-way, and four-way--to suit different types of installation. Select, for example, the four-way pattern for installation in the center of the room and three-way pattern for installation in the corner.

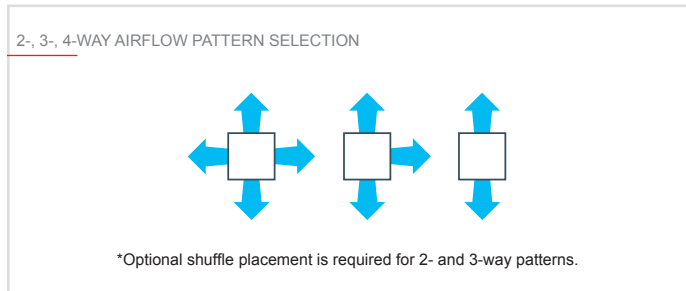

Individual vane angle settings

Vane direction can be changed or fixed from the remote controller to direct the supply air at or away from objects or occupants in the room.

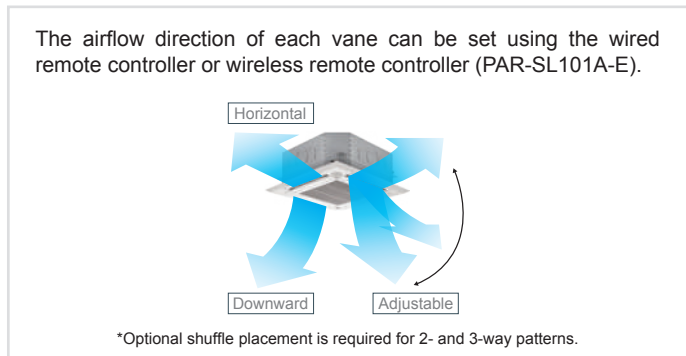

2-, 3-, 4-way airflow pattern selection

+

Individual vane angle settings

Combinations with individual vane settings enable an optimal outlet setting for each room layout to ensure even temperature distribution throughout each room. The result is uniformly comfortable air conditioning.

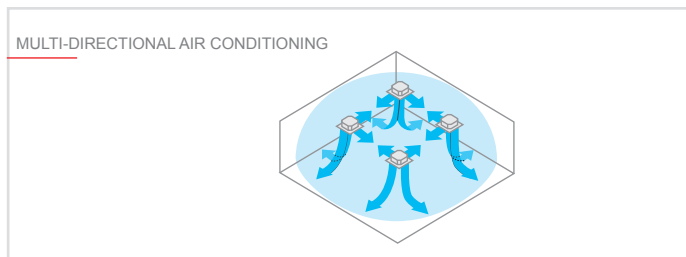

Equipped with high- and low-ceiling modes

Units are equipped with high- and low-ceiling operation modes that make it possible to switch the airflow volume to match the height of the room. Being able to choose the optimum airflow volume helps optimize the breezy sensation felt throughout the room.

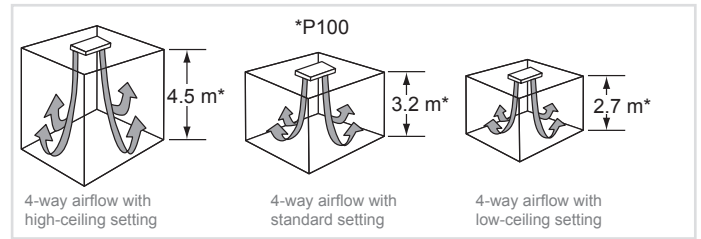

Airflow range

Model Airflow pattern	M20-M80			M100/M125		
	High-ceiling setting	Standard setting	Low-ceiling setting	High-ceiling setting	Standard setting	Low-ceiling setting
4-way	3.5 m	2.7 m	2.5 m	4.5 m	3.2 m	2.7 m
3-way	3.5 m	3.0 m	2.7 m	4.5 m	3.6 m	3.0 m
2-way	3.5 m	3.3 m	3.0 m	4.5 m	4.0 m	3.3 m

Automatic air-speed adjustment

An automatic air-speed mode automatically adjusts airflow speed to maintain comfortable room conditions at all times. This setting automatically adjusts the air speed to conditions that match the room environment.

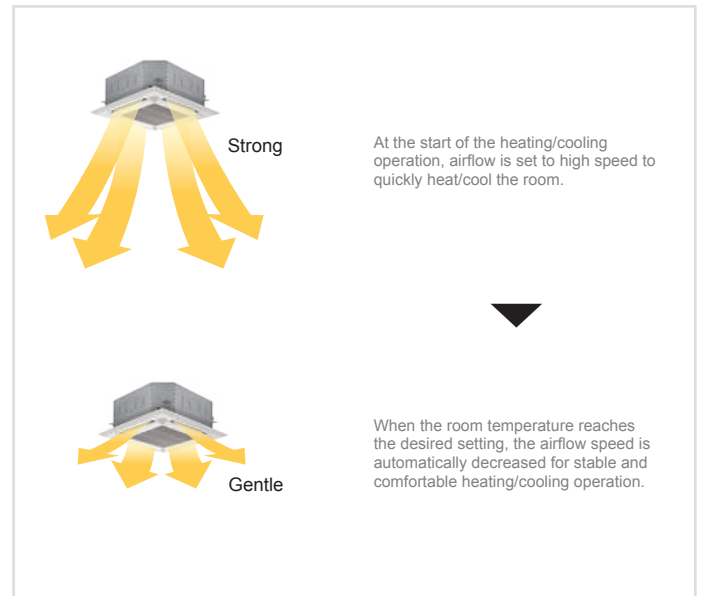

Panel and control

The unit is supplied with PLP-6EA panel which does not include signal receiver. This component (PAR-SE9FA-E) can be installed as a corner accessory, as well as 3D i-See Sensor (PAC-SE1ME-E). The unit is compatible with all wired MA and ME remote controls and, if equipped with signal receiver, wireless remote controls. New PAR-SL101A-E is compatible with PLFY-M VEM, and presents numerous new features, such as weekly timer, backlit display, 0,5°C temperature setting and monitoring, as well as functions for 3D i-see sensor (optional). Now it's possible to provide such as accessories also the new black panel PLP-6EAB. Not included 3D i-see sensor and without signal receiver.



Also, panel weight has been reduced by 20% thanks to a new design.



Connectable to Plasma Quad Connect

The optional Plasma Quad Connect PAC-SK51FT-E can be installed on the indoor units.

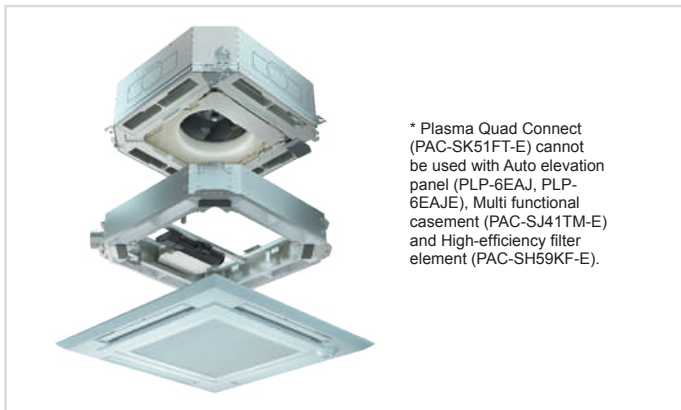

A simple loosening of support screws allows the removal of the control box and corner accessories.



Simplified installation

Thanks to new temporary panel supports maintenance and installation operation are now easier for field technicians.



Electrical box wiring

After reviewing the power supply terminal position in the electrical box, the structure has been redesigned to improve connectivity. This makes complex wiring work easier.



Increased space for plumbing work

The top and bottom positions of the liquid and gas pipes have been reversed to allow the gas pipe work, which requires more effort, to be completed first. Further, through structural innovations related to the space around the pipes, the area for the spanner has been increased, thus improving liquid piping work and enabling it to be completed smoothly.

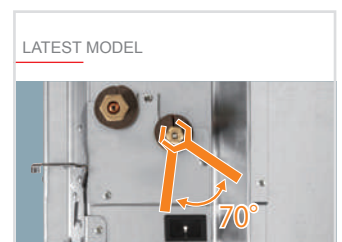

Technical specifications

MODEL			PLFY-M20VEM6-E	PLFY-M25VEM6-E	PLFY-M32VEM6-E	PLFY-M40VEM6-E	PLFY-M50VEM6-E
Power			1-phase 220-240V 50Hz, 1-phase 220V 60Hz				
Capacity in cooling mode*1		kW	2.2	2.8	3.6	4.5	5.6
		Btu/h	7500	9600	12300	15400	19100
Capacity in heating mode*1		kW	2.5	3.2	4.0	5.0	6.3
		Btu/h	8500	10900	13600	17100	21500
Power consumption	Cooling	kW	0.03	0.03	0.03	0.03	0.06
	Heating	kW	0.03	0.03	0.03	0.03	0.07
Current	Cooling	A	0.31	0.31	0.32	0.32	0.52
	Heating	A	0.24	0.24	0.25	0.25	0.60
External finish(Munsell No.)	Unit	Galvanized steel plate					
	Grille	MUNSELL (1.0Y 9.2/0.2)					
Dimensions (HxLxW)	Unit	mm	258x840x840				298 x 840 x 840
	Grille	mm	40x950x950				
Net weight	Unit	kg	19	19	19	19	24
	Grille	kg	5	5	5	5	5
Heat exchanger	Cross fin (Aluminium fin and copper tube)						
Fan	Type x Quantity	Turbo fan x 1					
	Air flow*2	m³/min	12-13-14-15	12-13-14-15	13-14-15-16	13-14-15-17	16 - 17 - 18 - 25 (Cooling) 16 - 17 - 18 - 28 (Heating)
		l/s	200-217-233-250	200-217-233-250	217-233-250-267	217-233-250-283	267 - 283 - 300 - 417 (Cooling) 267 - 283 - 300 - 467 (Heating)
	Static ext.l pressure	Pa	0	0	0	0	0
Motor	Type	DC Motor					
	Power output	kW	0.050	0.050	0.050	0.050	0.120
Air filter	Polypropilene honeycomb fabric						
Refrigerant pipe diameter	Gas (swaged)	mm	Ø 12.7	Ø 12.7	Ø 12.7	Ø 12.7	Ø 12.7
	Liquid (swaged)	mm	Ø 6.35	Ø 6.35	Ø 6.35	Ø 6.35	Ø 6.35
Local drain pipe diameter	Grille		O.D.32	O.D.32	O.D.32	O.D.32	O.D.32
Sound pressure*2*3		dB(A)	24-26-27-29	24-26-27-29	26-27-29-31	26-27-29-31	27 - 29 - 31 - 38(Cooling) 27 - 29 - 31 - 41(Heating)

*1 Cooling/Heating capacity is the maximum value measured in the following conditions.

Cooling: indoor 27°C (81°F) DB/19°C (66°F) WB, outdoor 35°C (95°F) BS. Heating: indoor 20°C (68°F) DB, outdoor 7°C (45°F) DB/6°C (43°F) WB.

*2 High-mid1-mid2-low setting

*3 Measured in anechoic chamber with 230V power supply.

Optional parts	DESCRIPTION
PAC-SK51FT-E	Plasma Quad Connect
PAC-SE1ME-E	Corner 3D I-see Sensor for PLFY-M VEM-E
PLP-6EALM	Panel with wireless remote controller
PLP-6EA	Panel
PLP-6EAB	Black Panel

Technical specifications

MODEL			PLFY-M63VEM6-E	PLFY-M71VEM6-E	PLFY-M80VEM6-E	PLFY-M100VEM6-E	PLFY-M125VEM6-E
Power			1-phase 220-240V 50Hz, 1-phase 220V 60Hz				
Capacity in cooling mode*1		kW	7.1	8.0	9.0	11.2	14.0
		Btu/h	24200	27300	30700	38200	47800
Capacity in heating mode*1		kW	8.0	9.0	10.0	12.5	16.0
		Btu/h	27300	30700	34100	42700	54600
Power consumption	Cooling	kW	0.09	0.12	0.12	0.12	0.12
	Heating	kW	0.12	0.12	0.12	0.12	0.12
Current	Cooling	A	0.74	0.97	0.97	0.97	0.97
	Heating	A	0.90	0.94	0.94	0.94	0.94
External finish(Munsell No.)	Unit	Galvanized steel plate					
	Grille	MUNSELL (1.0Y 9.2/0.2)					
Dimensions (HxLxW)	Unit	mm	298x840x840	298x840x840	298x840x840	298x840x840	298x840x840
	Grille	mm	40x950x950	40x950x950	40x950x950	40x950x950	40x950x950
Net weight	Unit	kg	24	27	27	27	27
	Grille	kg	5	5	5	5	5
Heat exchanger			Cross fin (Aluminium fin and copper tube)				
Fan	Type x Quantity		Turbo fan x 1				
	Air flow*2	m ³ /min	16 - 18 - 20 - 32 (Cooling) 16 - 18 - 20 - 35 (Heating)	16 - 18 - 20 - 35	16 - 20 - 23 - 35	17 - 22 - 28 - 35	17 - 24 - 31 - 35
		l/s	267 - 300 - 333 - 533 (Cooling) 267 - 300 - 333 - 583 (Heating)	267 - 300 - 333 - 583	267 - 333 - 383 - 583	283 - 367 - 467 - 583	283 - 400 - 517 - 583
	Static ext.l pressure	Pa	0	0	0	0	0
Motor	Type		DC Motor				
	Power output	kW	0.120	0.120	0.120	0.120	0.120
Air filter			Polypropilene honeycomb fabric				
Refrigerant pipe diameter	Gas (swaged)	mm	Ø 15.88	Ø 15.88	Ø 15.88	Ø 15.88	Ø 15.88
	Liquid (swaged)	mm	Ø 9.52	Ø 9.52	Ø 9.52	Ø 9.52	Ø 9.52
Local drain pipe diameter	Grille		O.D.32	O.D.32	O.D.32	O.D.32	O.D.32
Sound pressure*2*3		dB(A)	27 - 30 - 32 - 43(Cooling) 27 - 30 - 32 - 46(Heating)	28 - 31 - 35 - 46	28 - 33 - 37 - 46	29 - 35 - 41 - 46	30 - 37 - 45 - 46

*1 Cooling/Heating capacity is the maximum value measured in the following conditions.

Cooling: indoor 27°C (81°F) DB/19°C (66°F) WB, outdoor 35°C (95°F) BS. Heating: indoor 20°C (68°F) DB, outdoor 7°C (45°F) DB/6°C (43°F) WB.

*2 High-mid1-mid2-low setting

*3 Measured in anechoic chamber with 230V power supply.

Optional parts	DESCRIPTION
PAC-SK51FT-E	Plasma Quad Connect
PAC-SE1ME-E	Corner 3D I-see Sensor for PLFY-M VEM-E
PLP-6EALM	Panel with wireless remote controller
PLP-6EA	Panel
PLP-6EAB	Black Panel

PLFY-P VLMD-E

INDOOR UNITS - 2-way cassette

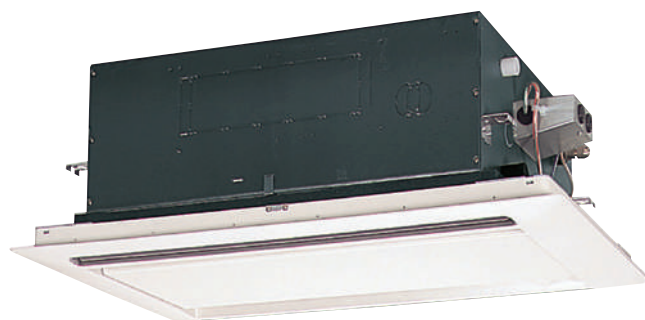

Ideal for...

The slimline housing is ideal for installation in small ceiling spaces and for replacing obsolete equipment in old buildings. In fact, the unit is just 290 mm high.

General characteristics

Terminal block

The terminal block is positioned on the outside of the main unit for easier wiring.

Direct external air intake

Clean air can enter the main unit directly (optional accessories required).

Long-life filter supplied as standard

The long-life antibacterial filter requires no maintenance for approximately one year.

Compact unit and low noise levels

15Pa noise levels (standard static pressure).

Condensate lift pump

The standard version is equipped with a mechanism with condensate lift pump. The drain can be positioned anywhere up to 583mm from the ceiling surface, allowing greater freedom of movement due to long transverse pipes and greater pipe layout versatility.

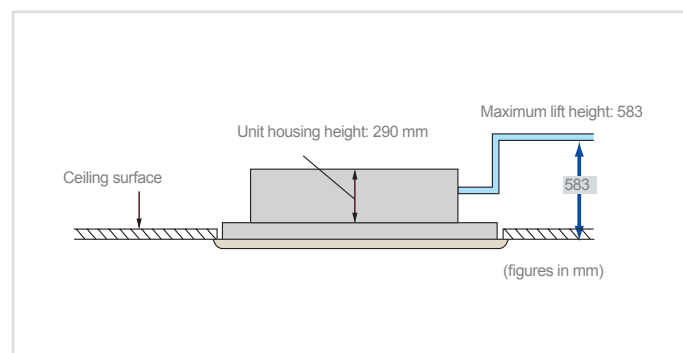

Noise level

dB(A)

Capacity		P20	P25	P32	P40	P50	P63	P80	P100	P125
Fan speed	High		33		36	37	39	39	42	46
	Medium		30		33	34	37	36	39	42/44
	Low		27		29	31	32	33	36	40

Easy installation

Installation and maintenance are made easier by the use of a lighter panel and the positioning of the switchboard close to the panel. In addition, the heat exchanger can be flushed by moving the central panel, filter and fan within the pipe layouts themselves.



Key Technologies

Technical specifications

MODEL			PLFY-P20VLMD-E	PLFY-P25VLMD-E	PLFY-P32VLMD-E	PLFY-P40VLMD-E
Power			Single phase, 220-240V 50Hz			
Capacity in cooling mode*1		kW	2.2	2.8	3.6	4.5
		Btu/h	7500	9600	12300	15400
Capacity in heating mode*1		kW	2.5	3.2	4.0	5.0
		Btu/h	8500	10900	13600	17100
Power consumption	Cooling	kW	0.072	0.072	0.072	0.081
	Heating	kW	0.065	0.065	0.065	0.074
Current	Cooling	A	0.36	0.36	0.36	0.40
	Heating	A	0.30	0.30	0.30	0.34
External finish	Galvanized steel plate					
	Nr. Munsel 6.4Y 8.9/0.4 (white)					
Dimensions AxLxP	Unit	mm	290x776x634	290x776x634	290x776x634	290x776x634
	Grille	mm	20x1080x710	20x1080x710	20x1080x710	20x1080x710
Net weight	Unit	kg	23	23	24	24
	Grille	kg	6.5	6.5	6.5	6.5
Heat exchanger			Cross fin (Al/Cu)			
Fan	Type x Quantity		Turbo fan x 1			
	Air flow*2	m³/min	6.5-8.0-9.5	6.5-8.0-9.5	6.5-8.0-9.5	7.0-8.5-10.5
		l/s	108-133-158	108-133-158	108-133-158	117-142-175
		cfm	230-283-335	230-283-335	230-283-335	247-300-371
Ext. Static pressure	Pa	0	0	0	0	
Motor	1-phase induction motor					
	Ext. Static pressure	kW	0.015 (a 240V)	0.015 (a 240V)	0.015 (a 240V)	0.015 (a 240V)
Air filter			Polypropylen honeycomb (long life)			
Refrigerant pipe diameter	Gas (swaged)	mm	ø12.7	ø12.7	ø12.7	ø12.7
	Liquid (swaged)	mm	ø6.35	ø6.35	ø6.35	ø6.35
Local drain pipe diameter		mm	O.D. 32	O.D. 32	O.D. 32	O.D. 32
Sound pressure*2*3		dB(A)	28-31-34	28-31-34	28-31-34	30-34-37

*1 The heating/cooling capacity indicates the maximum values during operation under the following conditions.

Cooling: indoor 27°C (81 °F) DB/19°C(66°F) WB, outdoor 35°C (95°F) DB. Heating: indoor 20°C (68°F) DB, outdoor 7°C (45°F) DB/6°C (43°F) WB.

*2 Airflow rate/noise levels are expressed as (low-middle1-middle2-high).

*3 Measured in an anechoic chamber.

Technical specifications

MODEL			PLFY-P50VLMD-E	PLFY-P63VLMD-E	PLFY-P80VLMD-E	PLFY-P100VLMD-E
Power	Single phase, 220-240V 50Hz					
Capacity in cooling mode*1	kW		5,6	7,1	9,0	11,2
	Btu/h		19100	24200	30700	38200
Capacity in heating mode*1	kW		6,3	8,0	10,0	12,5
	Btu/h		21500	27300	34100	42700
Power consumption	Cooling	kW	0,082	0,101	0,147	0,157
	Heating	kW	0,075	0,094	0,140	0,150
Current	Cooling	A	0,41	0,49	0,72	0,75
	Heating	A	0,35	0,43	0,66	0,69
External finish	Unit	Galvanized steel plate				
	Grille	Nr. Munsel 6.4Y 8.9/0.4 (white)				
Dimensions AxLxP	Unit	mm	290x946x634	290x946x634	290x1446x634	290x1446x634
	Grille	mm	20x1250x710	20x1250x710	20x1750x710	20x1750x710
Net weight	Unit	kg	23	28	44	47
	Grille	kg	7.5	7.5	12.5	12.5
Heat exchanger	Cross fin					
Fan	Type x Quantity		Turbo fan x 1	Turbo fan x 1	Turbo fan x 2	Turbo fan x 2
	Air flow*2	m³/min	6,5-8,0-9,5	11,0-13,0-15,5	15,5-18,5-22,0	17,5-21,0-25,0
		l/s	108-133-158	167-217-258	258-308-367	292-350-417
		cfm	230-283-335	353-459-547	547-653-777	618-742-883
Ext. Static pressure	Pa	0	0	0	0	
Motor	Type	1-phase induction motor				
	Ext. Static pressure	kW	0,020 (a 240V)	0,020 (a 240V)	0,020 (a 240V)	0,030 (a 240V)
Air filter	Polypropylen honeycomb (long life)					
Refrigerant pipe diameter	Gas (swaged)	mm	ø12,7	ø15,88	ø15,88	ø15,88
	Liquid (swaged)	mm	ø6,35	ø9,52	ø9,52	ø9,52
Local drain pipe diameter		mm	O.D.32	O.D.32	O.D.32	O.D.32
Sound pressure*2*3		dB(A)	32-35-38	33-38-40	34-37-40	37-41-43

*1 The heating/cooling capacity indicates the maximum values during operation under the following conditions.

Cooling: indoor 27°C (81°F) DB/19°C(66°F) WB, outdoor 35°C (95°F) DB. Heating: indoor 20°C (68° F) DB, outdoor 7°C (45° F) DB/6°C (43°F) WB.

*2 Airflow rate/noise levels are expressed as (low-middle1-middle2-high).

*3 Measured in an anechoic chamber.



PMFY-P VBM-E

INDOOR UNITS - 1-way cassette

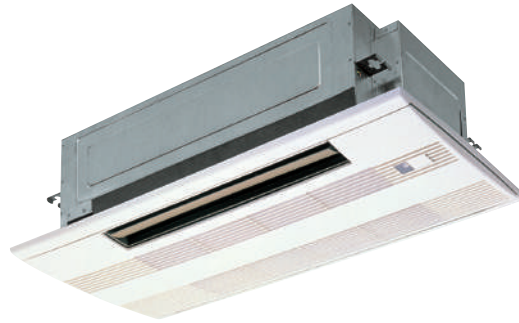

Ideal for...

Compact and light housing, perfect for applications in premises with a limited ceiling space.

Easy installation and maintenance

The dimensions of the unit housing have been standardised for all models at 854 mm to facilitate installation. The weight of the body is only 14 kg for the main unit and 3 kg for the panel, making this unit one of the lightest on the market.

Condensate lift pump

The condensate drain can be positioned anywhere up to 600 mm from the ceiling surface.

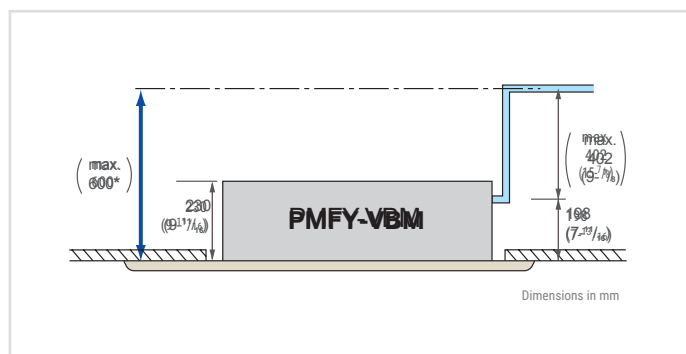

Silent operation

New airflow control technology reduces noise levels to just 27dB (P20VBM) for industry-leading quiet performance.

Improved Coanda effect

Thanks to this effect, the air tends to follow a trajectory that allows it to circulate more evenly in the air-conditioned environment.

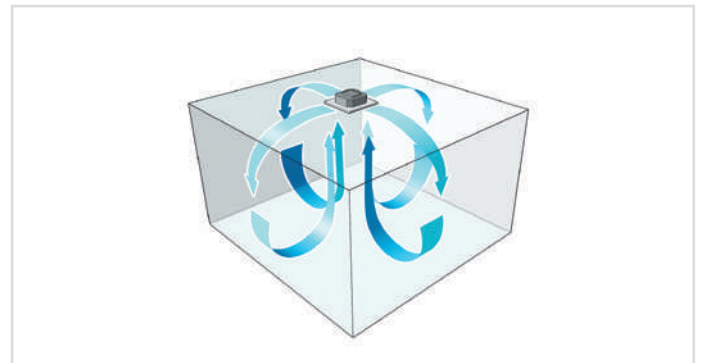



Key Technologies

Technical specifications

MODEL			PMFY-P20VBM-E	PMFY-P25VBM-E	PMFY-P32VBM-E	PMFY-P40VBM-E
Power	Single phase, 220-240V 50Hz					
Capacity in cooling mode*1		kW	2,2	2,8	3,6	4,5
		Btu/h	7500	9600	12300	15400
Capacity in heating mode*1		kW	2,5	3,2	4,0	5,0
		Btu/h	8500	10900	13600	17100
Power consumption	Cooling	kW	0,042	0,044	0,044	0,054
	Heating	kW	0,042	0,044	0,044	0,054
Current	Cooling	A	0,20	0,21	0,21	0,26
	Heating	A	0,20	0,21	0,21	0,26
External finish	Unit	Galvanized steel plate				
	Grille	Nr. Munsel 0.98Y 8.99/0.63				
Dimensions AxLxP	Unit	mm	230x812x395	230x812x395	230x812x395	230x812x395
	Grille	mm	30x1000x470	30x1000x470	30x1000x470	30x1000x470
Net weight	Unit	kg	14	14	14	14
	Grille	kg	3	3	3	3
Heat exchanger	Cross fin					
Fan	Type x Quantity	Linear Flow fan x 1				
	Air flow*2	m³/min	6,5-7,2-8,0-8,7	7,3-8,0-8,6-9,3	7,3-8,0-8,6-9,3	7,7-8,7-9,7-10,7
		l/s	108-120-133-145	122-133-143-155	122-133-143-155	128-145-162-178
		cfm	230-254-283-307	258-283-304-328	258-283-304-328	272-307-343-378
Ext. Static pressure	Pa	0	0	0	0	
Motor	Type	Single-phase induction motor				
	Ext. Static pressure	kW	0,028	0,028	0,028	0,028
Air filter	Polypropylen honeycomb (long life)					
Refrigerant pipe diameter	Gas (swaged)	mm	ø12,7	ø12,7	ø12,7	ø12,7
	Liquid (swaged)	mm	ø6,35	ø6,35	ø6,35	ø6,35
Local drain pipe diameter		mm	O.D. 26	O.D. 26	O.D. 26	O.D. 26
Sound pressure*2*3		dB(A)	27-30-33-35	32-34-36-37	32-34-36-37	33-35-37-39

*1 The heating/cooling capacity indicates the maximum values during operation under the following conditions.

Cooling: indoor 27°C (81 °F) DB/19°C(66°F) WB, outdoor 35°C (95°F) DB. Heating: indoor 20°C (68°F) DB, outdoor 7°C (45°F) DB/6°C (43° F) WB.

*2 Airflow rate/noise levels are expressed as (low-middle1-middle2-high).

*3 Measured in an anechoic chamber.

PEFY-P VMS1-E

INDOOR UNITS - Ceiling concealed medium to low static pressure



CITY MULTI

Ideal for...

This **ultra-slim 200 mm** unit offers extraordinary flexibility and is particularly suitable for use in rooms where low noise and compact vertical dimensions are essential.

Ultra-slim

These units are extremely thin, at just 200 mm in height. Extremely compact width and lengths of:
 7790 mm for P15 and P32 models
 990 mm for P40 and P50 models
 1190 mm for P63 models
 May be installed easily in cramped spaces such as ceiling recesses or double ceilings.

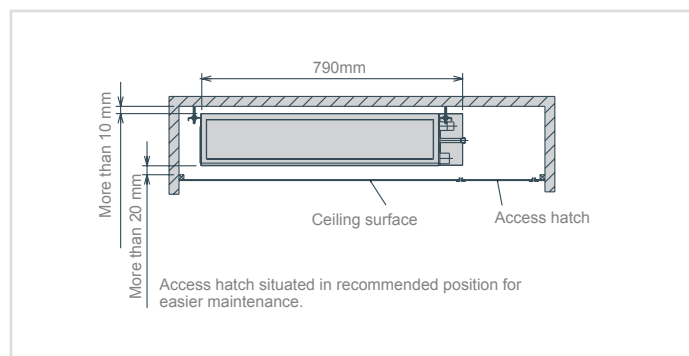

Condensate lift pump

The VMS1 is equipped with a condensate lift pump as standard.

Adjustable static pressure

L'unità è adatta per diverse applicazioni, grazie alle sue 4 impostazioni di presWith 4 selectable static pressure settings (5, 15, 25 and 50Pa), this unit is ideal for a variety of different applications.

Adjustable air flow

Three different fan speed settings - "low", "medium" and "high" – ensure the desired levels of comfort.

Low noise

The new design of the centrifugal fan and coil reduces noise levels.

Noise level dB(A)

Capacity		P15	P20	P25	P32	P40	P50	P63
Fan speed	High		28		32	33	35	36
	Medium		24		27	30	32	33
	Low		22		24	28	30	30



Key Technologies

Technical specifications

MODEL		PEFY-P15VMS1-E	PEFY-P20VMS1-E	PEFY-P25VMS1-E	PEFY-P32VMS1-E	PEFY-P40VMS1-E	PEFY-P50VMS1-E	PEFY-P63VMS1-E
Power		A single-phase, 220-240V 50Hz / a 1 fase, 220-240V 60Hz						
Capacity in cooling mode*1	kW	1.7	2.2	2.8	3.6	4.5	5.6	7.1
	Btu/h	5800	7500	9600	12300	15400	19100	24200
Capacity in heating mode*1	kW	1.9	2.5	3.2	4.0	5.0	6.3	8.0
	Btu/h	6500	8500	10900	13600	17100	21500	27300
Power consumption	Cooling kW	0.05 [0.03]	0.05 [0.03]	0.06 [0.04]	0.07 [0.05]	0.07 [0.05]	0.09 [0.07]	0.09 [0.07]
	Heating kW	0.03 [0.03]	0.03 [0.03]	0.04 [0.04]	0.05 [0.05]	0.05 [0.05]	0.07 [0.07]	0.07 [0.07]
Current	Cooling A	0.42 [0.31]	0.47 [0.36]	0.50 [0.39]	0.50 [0.39]	0.56 [0.45]	0.67 [0.56]	0.72 [0.61]
	Heating A	0.31 [0.31]	0.36 [0.36]	0.39 [0.39]	0.39 [0.39]	0.45 [0.45]	0.56 [0.56]	0.61 [0.61]
External finish		Galvanised						
Dimensions HxLxW	mm	200x790x700	200x790x700	200x790x700	200x790x700	200x990x700	200x990x700	200x1190x700
Net weight	kg	19 [18]	19 [18]	19 [18]	20 [19]	24 [23]	24 [23]	28 [27]
Heat exchanger		Cross fins (sheet aluminium fins and copper piping)						
Fan	Type x Quantity	Sirocco x 2			Sirocco x 3		Sirocco x 4	
	Air flow (low-medium-high) m³/min	5-6-7	5.5-6.5-8	5.5-7-9	6-8-10	8-9.5-11	9.5-11-13	12-14-16.5
	Static external press Pa	5-15-35-50	5-15-35-50	5-15-35-50	5-15-35-50	5-15-35-50	5-15-35-50	5-15-35-50
Motor	Type	Brushless DC motor						
	Power output kW	0.096	0.096	0.096	0.096	0.096	0.096	0.096
Air filter		Polypropylene honeycomb fabric (washable)						
Refrigerant pipe diameter	Gas (swaged) mm	ø12.7 brazed	ø12.7 brazed	ø12.7 brazed	ø12.7 brazed	ø12.7 brazed	ø12.7 brazed	ø15.88 brazed
	Liquid (swaged) mm	ø6.35 brazed	ø6.35 brazed	ø6.35 brazed	ø6.35 brazed	ø6.35 brazed	ø6.35 brazed	ø9.52 brazed
Local drain pipe diameter		O.D. 32	O.D. 32	O.D. 32	O.D. 32	O.D. 32	O.D. 32	O.D. 32
Sound pressure (low-medium-high)	dB(A)	22-24-28	23-25-29	24-26-30	24-27-32	28-30-33	30-32-35	30-33-36

*1 For heating/cooling capacity, the maximum value with the unit operating in the following conditions is given.
 Cooling: indoor 27°C DB/19°C WB, outdoor 35°C DB.
 Heating: indoor 20°C DB (68°F DB), outdoor 7°C DB (45°F DB/43°F WB). Pipe length: 7.5 m (24-9/16 feet).
 Height difference: 0 m (0 feet).

*2 Static external pressure is set to 15 Pa by default.

*3 [] in case of PEFY-P15-63VMS1L-E.

PEFY-M VMA-A1

INDOOR UNITS - Ceiling concealed medium to high static pressure



CITY MULTI

Five levels of external static pressure settings

Five-stage external static pressure settings provide flexibility for duct extension, branching, and air outlet configuration and are adjustable to meet different application conditions. Settings range to a maximum of 150Pa.

External static pressure setting

Series	20	25	32	40	50	63	71	80	100	125	140
PEFY-M VMA-A1	35/50/70/100/150 Pa						40/50/70/100/150 Pa				

Four fan speeds to choose from

The conventional models had three levels of fan speed, but the new models offer four levels (Low/Mid2/Mid1/High). Combined with a wider selection of external static pressure levels, the new models offer optimal operation settings to suit the air-conditioning load of the installation space.

Air inlet direction can be easily changed

By simply switching the closing board and air filter, the inlet layout can be changed from the rear inlet to the bottom inlet. (At factory shipment: Rear inlet)

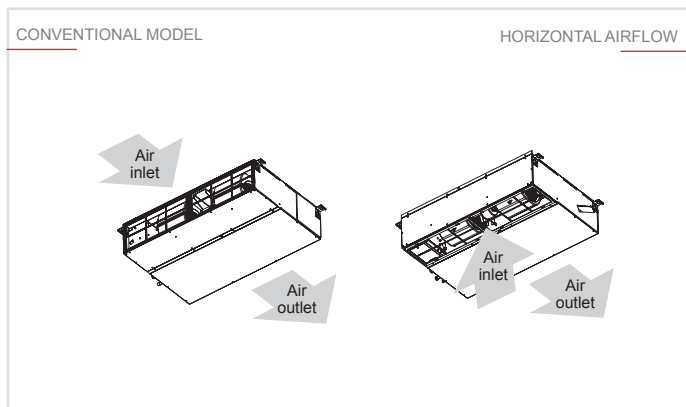

Optional drain pump

The lineup consists of two types of models, with or without a built-in drain pump, for more flexibility in piping layout design.



Built-in drain pump
PEFY-M VMA-A1

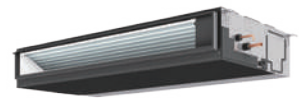

No drain pump
PEFY-M VMAL-A1

*Units with an "L" at the end of the model name are not equipped with a drain pump.

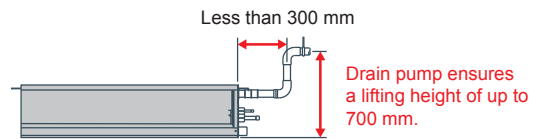

Connectable to Plasma Quad Connect

The optional Plasma Quad Connect MAC-100FT-E can be installed on the indoor unit's air inlet side. For installation, PQ attachment or PQ box is required.



Key Technologies

Technical specifications

MODEL			PEFY-M20VMA-A1	PEFY-M25VMA-A1	PEFY-M32VMA-A1	PEFY-M40VMA-A1	
Power	1-phase 220-230-240 V 50 Hz						
Capacity in cooling mode *1	kW	2.2	2.8	3.6	4.5		
	Btu/h	7,500	9,600	12,300	15,400		
Capacity in heating mode*1	kW	2.5	3.2	4.0	5.0		
	Btu/h	8,500	10,900	13,600	17,100		
Power consumption	Cooling kW	0.039	0.039	0.060	0.087		
	Heating kW	0.037	0.037	0.058	0.085		
Current	Cooling A	0.34-0.33-0.32	0.34-0.33-0.32	0.50-0.48-0.46	0.70-0.67-0.64		
	Heating A	0.34-0.33-0.32	0.34-0.33-0.32	0.50-0.48-0.46	0.70-0.67-0.64		
External finish	Galvanized steel plate						
Dimensions HxLxW	mm	250 x 700 x 732	250 x 700 x 732	250 x 700 x 732	250 x 900 x 732		
Net weight	kg	21	21	21	25		
Heat exchanger	Cross fin (Aluminum fin and copper tube)						
Fan	Type x Quantity	Sirocco fan x 1		Sirocco fan x 1		Sirocco fan x 2	
	Air flow (low-medium-high)	m³/min	6.0 - 7.5 - 8.5 - 10.0	6.0 - 7.5 - 8.5 - 10	7.4 - 9.0 - 10.5 - 12.5	10.0 - 11.5 - 13.5 - 19.0	
		l/s	100 - 125 - 142 - 166	100 - 125 - 142 - 166	123 - 150 - 175 - 208	166 - 191 - 225 - 316	
		cfm	212 - 265 - 300 - 353	212 - 265 - 300 - 353	261 - 317 - 370 - 441	353 - 406 - 476 - 670	
External static press *2	Pa	35 - <50> - <70> - <100> - <150>	35 - <50> - <70> - <100> - <150>	35 - <50> - <70> - <100> - <150>	35 - <50> - <70> - <100> - <150>		
Motor	Type	DC Motor					
	Power output kW	0.085	0.085	0.085	0.121		
Air filter	Polypropylene honeycomb fabric (washable)						
Refrigerant pipe diameter	Gas (brazed) mm	12.7	12.7	12.7	12.7		
	Liquid (brazed) mm	6.35	6.35	6.35	6.35		
Local drain pipe diameter	O.D.32 (1-1/4")						
Sound pressure (Low-Mid2-Mid1-High)*3	Cooling dB(A)	21.5 - 23.0 - 26.5 - 30.0	21.5 - 23.0 - 26.5 - 30.0	23.0 - 26.5 - 29.5 - 33.5	23.5-25.5-28.5-37.0		
	Heating dB(A)	21.5 - 23.0 - 26.5 - 30.0	21.5 - 23.0 - 26.5 - 30.0	23.0 - 26.5 - 29.5 - 33.5	23.5-25.5-28.5-37.0		

*1 For heating/cooling capacity, the maximum value with the unit operating in the following conditions is given.

Cooling: indoor 27°C (81°F) DB/19°C (66°F) WB, outdoor 35°C (95°F) DB. Heating: indoor 20°C (68°F) DB, outdoor 7°C (45°F) DB/6°C (43°F) WB.

*2 The factory setting of airflow mode and external static pressure mode is shown without < >.

*3 Measured in anechoic chamber with 230V mains power and at the factory setting of external static pressure.

Technical specifications

MODEL			PEFY-M50VMA-A1	PEFY-M63VMA-A1	PEFY-M71VMA-A1	PEFY-M80VMA-A1
Power	1-phase 220-230-240 V 50 Hz					
Capacity in cooling mode *1	kW		5.6	7.1	8.0	9.0
	Btu/h		19,100	24,200	27,300	30,700
Capacity in heating mode*1	kW		6.3	8.0	9.0	10.0
	Btu/h		21,500	27,300	30,700	34,100
Power consumption	Cooling	kW	0.131	0.139	0.165	0.165
	Heating	kW	0.129	0.231	0.216	0.216
Current	Cooling	A	0.94-0.90-0.86	0.99-0.95-0.91	1.16-1.11-1.06	1.16-1.11-1.06
	Heating	A	0.94-0.90-0.86	1.55-1.48-1.42	1.47-1.41-1.35	1.47-1.41-1.35
External finish	Galvanized steel plate					
Dimensions HxLxW	mm		250 x 1100 x 732	250 x 1100 x 732	250 x 1400 x 732	250 x 1400 x 732
Net weight	kg		30	30	37	37
Heat exchanger	Cross fin (Aluminum fin and copper tube)					
Fan	Type x Quantity		Sirocco fan x 2	Sirocco fan x 2	Sirocco fan x 3	Sirocco fan x 3
	Air flow (low-medium-high)	m³/min	12.0 - 14.5 - 16.5 - 25.6	13.5 - 16.0 - 19.2 - 26.2	14.5 - 18.0 - 21.0 - 33.1	14.5 - 18.0 - 21.0 - 33.1
		l/s	208 - 241 - 275 - 426	225 - 266 - 320 - 436	241 - 300 - 350 - 518	241 - 300 - 350 - 518
		cfm	441 - 511 - 582 - 903	476 - 564 - 677 - 925	511 - 635 - 741 - 1098	511 - 635 - 741 - 1098
External static press ²	Pa	35 - <50> - <70> - <100> - <150>	35 - <50> - <70> - <100> - <150>	40 - <50> - <70> - <100> - <150>	40 - <50> - <70> - <100> - <150>	
Motor	Type	DC Motor				
	Power output	kW	0.121	0.121	0.300	0.300
Air filter	Polypropylene honeycomb fabric (washable)					
Refrigerant pipe diameter	Gas (brazed)	mm	12.7	15.88	15.88	15.88
	Liquid (brazed)	mm	6.35	9.52	9.52	9.52
Local drain pipe diameter	O.D.32 (1-1/4")					
Sound pressure (Low-Mid2-Mid1-High) ³	Cooling	dB(A)	22.0-24.0-26.5-37.0	23.0-26.0-30.0-37.5	22.0-25.0-27.5-38.5	22.0-25.0-27.5-38.5
	Heating	dB(A)	22.0-24.0-26.5-37.0	23.0-26.0-30.0-41.5	22.0-25.0-27.5-40.5	22.0-25.0-27.5-40.5

*1 For heating/cooling capacity, the maximum value with the unit operating in the following conditions is given.
 Cooling: indoor 27°C (81°F) DB/19°C (66°F) WB, outdoor 35°C (95°F) DB. Heating: indoor 20°C (68°F) DB, outdoor 7°C (45°F) DB/6°C (43°F) WB.
² The factory setting of airflow mode and external static pressure mode is shown without < >.
³ Measured in anechoic chamber with 230V mains power

Technical specifications

MODEL			PEFY-M100VMA-A1	PEFY-M125VMA-A1	PEFY-M140VMA-A1
Power	1-phase 220-230-240 V 50 Hz				
Capacity in cooling mode *1	kW		11.2	14.0	16.0
	Btu/h		38,200	47,800	54,600
Capacity in heating mode*1	kW		12.5	16.0	18.0
	Btu/h		42,700	54,600	61,400
Power consumption	Cooling	kW	0.211	0.218	0.282
	Heating	kW	0.140	0.197	0.206
Current	Cooling	A	1.44-1.38-1.32	1.40-1.33-1.28	1.84 - 1.76 - 1.69
	Heating	A	1.44-1.38-1.32	1.40-1.33-1.28	1.84 - 1.76 - 1.69
External finish	Galvanized steel plate				
Dimensions HxLxW	mm		250 x 1400 x 732	250 x 1400 x 732	250 x 1600 x 732
Net weight	kg		37	38	42
Heat exchanger	Cross fin (Aluminum fin and copper tube)				
Fan	Type x Quantity		Sirocco fan x 3	Sirocco fan x 3	Sirocco fan x 3
	Air flow (low-medium-high)	m³/min	23.0 - 28.0 - 32.0 - 37.0	25.5 - 31.0 - 34.0 - 37.0	29.5 - 35.5 - 40.0 - 44.0
		l/s	383 - 466 - 533 - 616	425 - 516 - 566 - 616	491 - 591 - 666 - 733
		cfm	812 - 988 - 1129 - 1306	900 - 1094 - 1200 - 1306	1041 - 1253 - 1412 - 1553
External static press ²	Pa	40 - <50> - <70> - <100> - <150>	40 - <50> - <70> - <100> - <150>	40 - <50> - <70> - <100> - <150>	
Motor	Type	DC Motor			
	Power output	kW	0.300	0.300	0.300
Air filter	Polypropylene honeycomb fabric (washable)				
Refrigerant pipe diameter	Gas (swaged)	mm	15.88	15.88	15.88
	Liquid (swaged)	mm	9.52	9.52	9.52
Local drain pipe diameter	O.D.32 (1-1/4")				
Sound pressure (Low-Mid2-Mid1-High) ³	Cooling	dB(A)	29.5 - 34.0 - 37.5 - 40.0	31.5 - 36.5 - 38.5 - 40.5	34.0 - 38.0 - 40.5 - 43.0
	Heating	dB(A)	29.5 - 34.0 - 37.5 - 40.0	31.5 - 36.5 - 38.5 - 40.5	34.0 - 38.0 - 40.5 - 43.0

*1 For heating/cooling capacity, the maximum value with the unit operating in the following conditions is given.
 Cooling: indoor 27°C (81°F) DB/19°C (66°F) WB, outdoor 35°C (95°F) DB. Heating: indoor 20°C (68°F) DB, outdoor 7°C (45°F) DB/6°C (43°F) WB.
² The factory setting of airflow mode and external static pressure mode is shown without < >.
³ Measured in anechoic chamber with 230V mains power



PEFY-P VMHS-E

INDOOR UNITS - Ceiling concealed high static pressure



CITY MULTI

Four levels of external static pressure settings

Although the conventional models only had three levels of external static pressure, the new models offer four levels of external static pressure. The additional external static pressure capacity provides flexibility for duct extension, branching and air outlet configuration.

PEFY-P VMHS-E	P40	P50	P63	P71	P80	P100	P125	P140
External static pressure (Pa)	50-<100>-<150>-<200>							

The factory setting of external static pressure is shown without < > . Refer to "Fan characteristics curves", according to the external static pressure, in DATA BOOK for the usable range of air flow rate.

Three fan speeds (Low/Mid/High) to choose from

The conventional models had two levels of fan speed, the new models offer three levels of fan speed (Low/Mid/High). Combined with a wider selection of external static pressure levels, the new models offer optimal operation settings to suit the air-conditioning load of an Installation space.

Reduction weight

Downsizing of the motor helped reduce unit weight, offering easier installation.

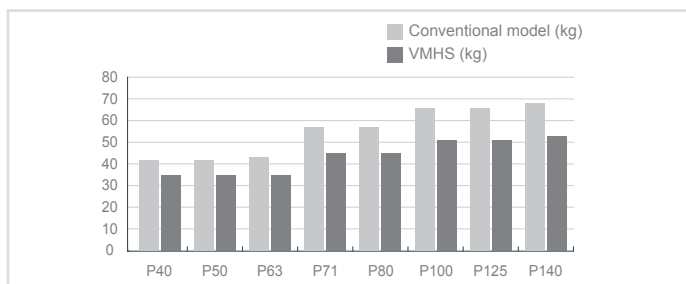

The use of DC motor

The new models are equipped with high-efficiency DC motors as compared to the AC motors on older models, which reduced power consumption. On the P80 models, power consumption is reduced by 59%*.

*Comparison made at 50 Hz, 220 V, 100 Pa Low fan speed

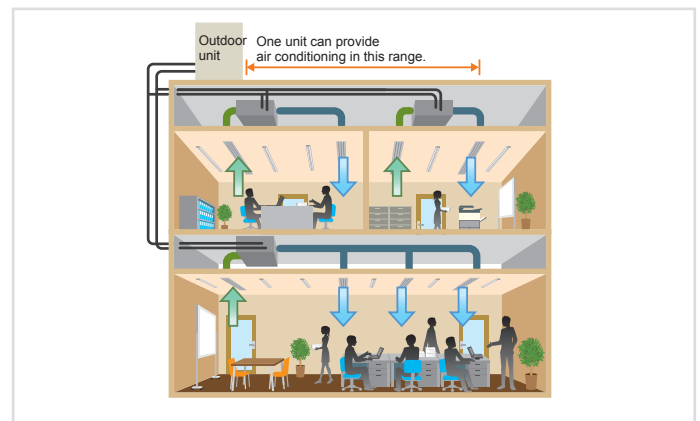

Optional drain pump

Use of high-efficiency DC motor for the drain pump motor on the new models reduces power consumption by 90%, in comparison to that on the conventional models. The pump head height of 550 mm provides for greater piping design flexibility.

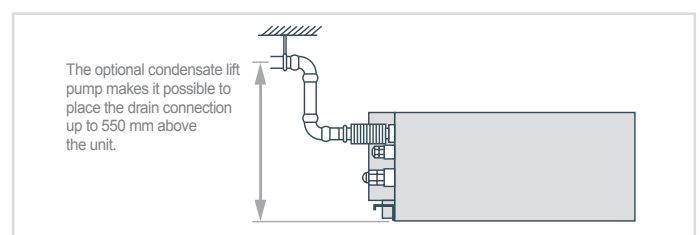



Key Technologies

Technical specifications

MODEL		PEFY-P40VMHS-E	PEFY-P50VMHS-E	PEFY-P63VMHS-E	PEFY-P71VMHS-E	PEFY-P80VMHS-E	PEFY-P100VMHS-E	PEFY-P125VMHS-E	PEFY-P140VMHS-E	
Power		A single-phase, 220-230-240V 50/60 Hz								
Capacity in cooling mode *1	kW	4,5	5,6	7,1	8,0	9,0	11,2	14,0	16,0	
	Btu/h	15,400	19,100	24,200	27,300	30,700	38,200	47,800	54,600	
Capacity in heating mode*1	kW	5,0	6,3	8,0	9,0	10,0	12,5	16,0	18,0	
	Btu/h	17,100	21,500	27,300	30,700	34,100	42,700	54,600	61,400	
Power consumption	Cooling kW	0,055	0,055	0,090	0,075	0,090	0,160	0,160	0,190	
	Heating kW	0,055	0,055	0,090	0,075	0,090	0,160	0,160	0,190	
Current	Cooling A	0,41-0,39-0,38	0,41-0,39-0,38	0,64-0,62-0,59	0,54-0,52-0,50	0,63-0,61-0,58	1,05-1,01-0,96	1,05-1,01-0,96	1,24-1,19-1,14	
	Heating A	0,41-0,39-0,38	0,41-0,39-0,38	0,64-0,62-0,59	0,54-0,52-0,50	0,63-0,61-0,58	1,05-1,01-0,96	1,05-1,01-0,96	1,24-1,19-1,14	
External finish		Galvanized								
Dimensions HxLxW	mm	380x745x900	380x745x900	380x745x900	380x1030x900	380x1030x900	380x1195x900	380x1195x900	380x1195x900	
Net weight	kg	35	35	35	45	45	51	51	53	
Heat exchanger		Cross fins (aluminium fins and copper piping)								
Fan	Type x Quantity	Sirocco x 1		Sirocco x 1	Sirocco x 2	Sirocco x 2	Sirocco x 2	Sirocco x 2	Sirocco x 2	
	Air flow (low-medium-high)	m³/min	10,0-12,0-14,0	10,0-12,0-14,0	13,5-16,0-19,0	15,5-18,0-22,0	18,0-21,5-25,0	26,5-32,0-38,0	26,5-32,0-38,0	28,0-34,0-40,0
		l/s	167-200-233	167-200-233	225-267-317	258-300-367	300-358-417	442-533-633	442-533-633	467-567-667
	cfm	353-424-494	353-424-494	477-565-671	547-636-777	636-759-883	936-1130-1342	936-1130-1342	989-1201-1412	
Static external press	Pa	50 - 100 -150 - 200	50 - 100 -150 - 200	50 - 100 -150 - 200	50 - 100 -150 - 200	50 - 100 -150 - 200	50 - 100 -150 - 200	50 - 100 -150 - 200	50 - 100 -150 - 200	
Motor	Type	Motor DC								
	Power output	kW	0,121	0,121	0,121	0,244	0,244	0,375	0,375	0,375
Air filter		-								
Refrigerant pipe diameter	Gas (swaged)	mm	12,7	12,7	15,88	15,88	15,88	15,88	15,88	15,88
	Liquid (swaged)	mm	6,35	6,35	9,52	9,52	9,52	9,52	9,52	9,52
Local drain pipe diameter		O.D 32								
Sound pressure (low-medium-high)*2	dB(A)	20-23-27	20-23-27	24-27-32	24-26-30	25-27-30	27-31-34	27-31-34	27-32-36	

*1 For heating/cooling capacity, the maximum value with the unit operating in the following conditions is given:

Cooling: 27°C DB / 19°C WB, outdoor 35°C DB.

Heating: 27°C DB, outdoor 7°C DB / 6°C WB.

*2 Static pressure is set to 50 Pa by default.

*3 Measured in anechoic chamber.

PEFY-P VMHS-E

INDOOR UNITS - Ceiling concealed high static pressure

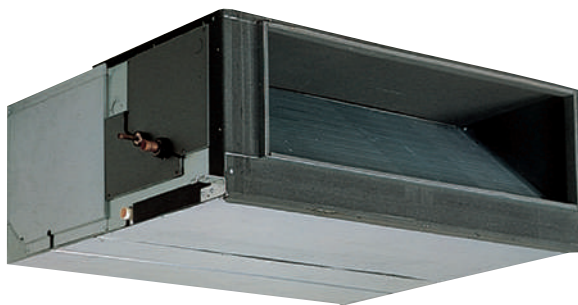

CITY MULTI

Ideal for...

The new VMHS series: improved **installation flexibility** and superior performance.

DC Inverter motor

The new VMHS ducted indoor units are equipped with a single-phase DC Inverter electric motor, a solution that offers more precise electronic control and less noise.

Remotely settable static overpressure

The static overpressure may be modified from a remote control. In addition to a dip switch on the unit, the PAR-41MAA remote control may also be used to modify static external pressure, making installation significantly simpler.

A choice of up to five different settings is available: 50, 100, 150, 200 or 250 Pa.

Automatic fan speed adjustment

The automatic fan speed adjustment mode ensures fast, comfortable heating as soon as heating mode is activated. Automatic fan speed control is included in the three standard modes "Low", "Medium" and "High", and ensures faster, comfortable air conditioning by increasing the air flow speed on activation and then reducing speed once stable comfort levels are attained.

Quieter

The VMHS series is 15% quieter than the previous VMH model.

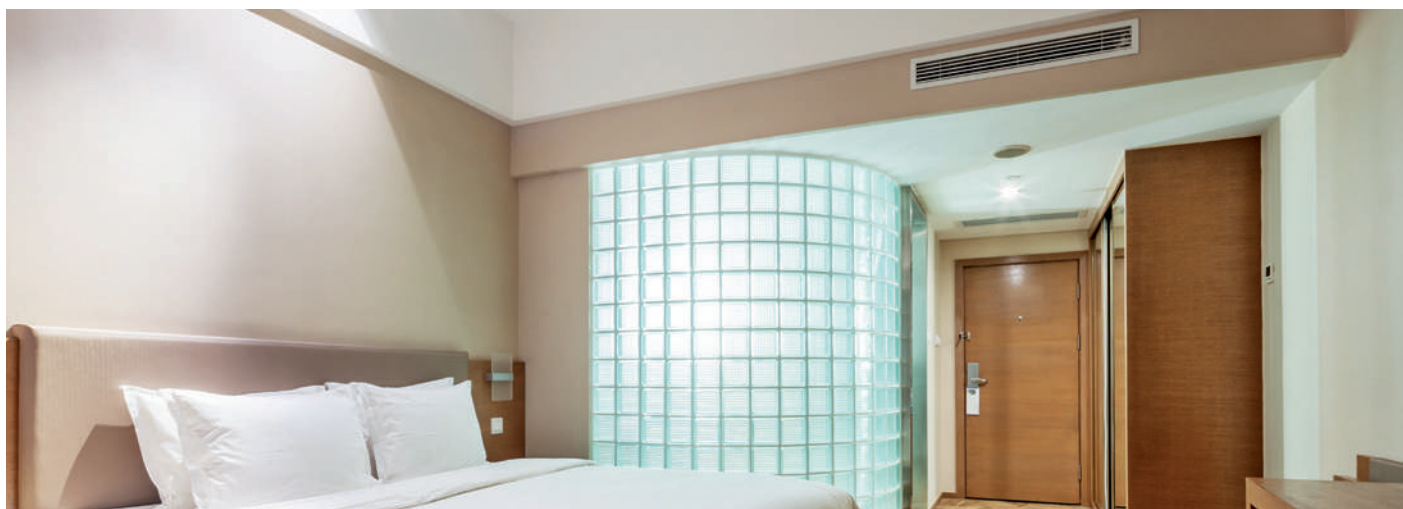

Key Technologies

Technical specifications

MODEL			PEFY-P200VMHS-E	PEFY-P250VMHS-E
Power	A single-phase, 220-240V, 50Hz			
Capacity in cooling mode *1		kW	22.4	28.0
		Btu/h	76,000	95,500
Capacity in heating mode*1		kW	25.0	31.5
		Btu/h	72,300	90,400
Power consumption	Cooling	kW	0.63/0.63/0.63	0.82/0.82/0.82
	Heating	kW	0.63/0.63/0.63	0.82/0.82/0.82
Current	Cooling	A	3.47/3.32/3.18	4.72/4.43/4.14
	Heating	A	3.47/3.32/3.18	4.72/4.43/4.14
External finish	Galvanised			
Dimensions HxLxW		mm	470 x 1250 x 1120	470 x 1250 x 1120
Net weight		kg	97	100
Heat exchanger	Cross Fin			
Fan	Type x Quantity		Sirocco x 2	
	Air flow (low-medium-high)	m ³ /min	50-61-72	
	Static external press*2	Pa	(50)/(100)/150/(200)/(250)	
Motor	Type		Single-phase induction motor	
	Power output	kW	0.87	0.87
Air filter			-	-
Refrigerant pipe diameter	Gas (swaged)	mm	19.05	22.2
	Liquid (swaged)	mm	9.52	9.52
Local drain pipe diameter			32	32
Sound pressure (low-medium-high)*3		dB(A)	36-39-43	39-42-46

*1 For heating/cooling capacity, the maximum value with the unit operating in the following conditions is given:

Cooling: 27°C DB / 19°C WB, outdoor 35°C DB.

Heating: 27°C DB, outdoor 7°C DB / 6°C WB.

*2 Static pressure is set to 150 Pa by default.

*3 Measured in anechoic chamber.

PCFY-P VKM-E

INDOOR UNITS - Ceiling-suspended



CITY MULTI

Ideal for...

Designed and built for quiet operation and simple maintenance, these units deliver efficient, comfortable air conditioning performance.

Optimised air flow

Air flow speed is optimised for the height of the ceiling. The ideal air flow setting may be selected for ceilings up to 4.2m in height, maximising both air conditioning efficacy and comfort.

Extremely simple installation

With the direct mount system, it is not necessary to remove the mounting from the main unit, cutting installation times.

The condensate drain pipes may be connected on the left or right of the unit.

Automatic fan speed adjustment

As well as the 4 manual fan speed settings, the PCFY series may also be set to automatically adjust fan speed in relation to ambient conditions: the fan speed is always set to the highest setting when the unit is switched on, to reach the desired conditions more quickly, and is reduced automatically near the setpoint for stable comfort.

Extra slim

Extremely slim and with elegant curves, the PCFY series is perfectly suited to any interior. The unit also features a single air outlet, meaning that the automatic swing vane also doubles as a shutter when the unit is off.



Automatic swing vane

The automatic swing vane mode distributes air more uniformly. The vane swings upwards and downwards automatically to distribute air effectively into every corner of the room.

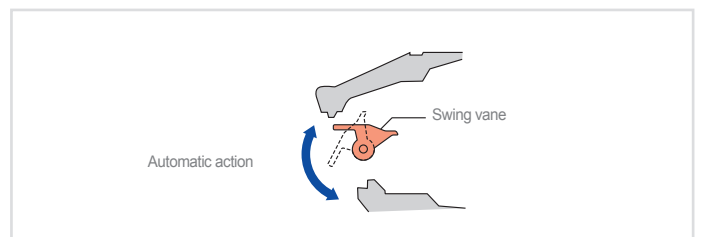



Key Technologies

Technical specifications

MODEL			PCFY-P40VKM-E	PCFY-P63VKM-E	PCFY-P100VKM-E	PCFY-P125VKM-E	
Power	A single-phase, 220-230-240VAC 50Hz						
Capacity in cooling mode*1	kW		4.5	7.1	11.2	14.0	
	Btu/h		15400	24200	38200	47800	
Capacity in heating mode*1	kW		5.0	8.0	12.5	16.0	
	Btu/h		17100	27300	42700	54600	
Power consumption	Cooling	kW	0.04	0.05	0.09	0.11	
	Heating	kW	0.04	0.05	0.09	0.11	
Current	Cooling	A	0.28	0.33	0.65	0.76	
	Heating	A	0.28	0.33	0.65	0.76	
External finish	Munsell 6.4Y 8.9/ 0.4						
Dimensions HxLxW	mm		230x960x680	230x1280x680	230x1600x680	230x1600x680	
Net weight	kg		24	32	36	38	
Heat exchanger	Cross fins (aluminium fins and copper piping)						
Fan	Type x Quantity		Sirocco x 2	Sirocco x 3	Sirocco x 4	Sirocco x 4	
	Air flow (low-medium-high)	m³/min	10-11-12-13	14-15-16-18	21-24-26-28	21-24-27-31	
		l/s	167-183-200-217	233-250-267-300	350-400-433-467	350-400-450-517	
	Static external press	Pa	0	0	0	0	
Motor	Type	Single-phase DC motor					
	Power output	kW	0.090	0.095	0.160	0.160	
Air filter	Polypropylene honeycomb fabric (long life)						
Refrigerant pipe diameter	Gas (swaged)	mm	ø12.7	ø15.88	ø15.88 / ø19.05 (compatible)	ø15.88 / ø19.05 (compatible)	
	Liquid (swaged)	mm	ø6.35	ø9.52	ø9.52	ø9.52	
Local drain pipe diameter	O.D. 26 (1)						
Sound pressure (low-medium-high)*2		dB(A)	29-32-34-36	31-33-35-37	36-38-41-43	36-39-42-44	

*1 For heating/cooling capacity, the maximum value with the unit operating in the following conditions is given.

Cooling: indoor 27°C (81°F) DB/19°C (66°F) WB, outdoor 35°C (95°F) DB. Heating: indoor 20°C (68°F) DB, outdoor 7°C (45°F) DB/6°C (43°F) WB.

*2 Air flow/noise levels given for operation in low-medium1-medium2-high modes.

*3 Measured in anechoic chamber.

PKFY-P VLM-E

INDOOR UNITS - Wall-mounted



CITY MULTI

New design

A sharp and simple form that combines beauty and function. The simple square design harmonizes beautifully with the straight lines created by the intersection of the walls, floor and ceiling of the space. With a new white body color, it is the ideal solution for residential applications, offices and large stores.

New line-up

New exclusive P10 model is added in wall mounted lineup. P10 size allows to respond to the needs of narrow spaces conditioning them finely. In addition, miniaturization of conventional P32 model has been realized. It contributes to space saving of installation area.

Capacity	P10	P15	P20	P25	P32	P40	P50	P63	P100
VLM	NEW	•	•	•	•	•	•		

Horizontal airflow

The vane angle can be set to five steps, including the one that allows horizontal air flow, reducing the feeling of draft. Besides, 4 steps of air speed are available.

		Fan Speed 	Vane Control	
			Vane Angle 	Swing mode
Conventional	PKFY-P** VBM	4 speeds	4 steps	---
	PKFY-P** VHM	3 speeds + AUTO	5 steps	✓

NEW	PKFY-P** VLM-E	4 speeds + AUTO	5 steps	✓
------------	-------------------	-----------------------	---------	---

Quietness...

The noise level has been significantly reduced compared to the conventional model by reviewing the unit structure and improving the line flow fan.

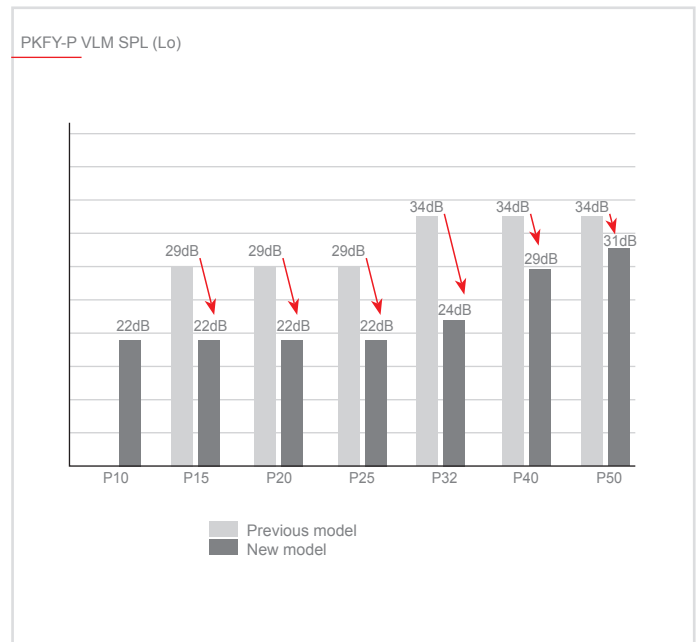



Key Technologies

Technical specifications

MODEL		PKFY-P10VLM-E	PKFY-P15VLM-E	PKFY-P20VLM-E	PKFY-P25VLM-E	PKFY-P32VLM-E	PKFY-P40VLM-E	PKFY-P50VLM-E	
Power		A single-phase, 220-240V 50Hz, A single-phase, 220-230V 60Hz							
Capacity in cooling mode*1	kW	1.2	1.7	2.2	2.8	3.6	4.5	5.6	
	Btu/h	4100	5800	7500	9600	12300	15400	19100	
Capacity in heating mode*1	kW	1.4	1.9	2.5	3.2	4.0	5.0	6.3	
	Btu/h	4800	6500	8500	10900	13600	17100	21500	
Power consumption	Cooling	kW	0.02	0.02	0.02	0.03	0.04	0.04	0.05
	Heating	kW	0.01	0.01	0.01	0.02	0.03	0.03	0.04
Current	Cooling	A	0.20	0.20	0.20	0.25	0.35	0.35	0.45
	Heating	A	0.15	0.15	0.15	0.20	0.30	0.30	0.40
External finish		Plastic (0.7PB 9.2/0,4)							
Dimensions HxLxW	mm	299 x 773 x 237					299 x 898 x 237		
Net weight	kg	11 (25)					13 (29)		
Heat exchanger		Cross fin (Aluminium fin and copper tube)							
Fan	Type x Quantity	Line flow fan x 1							
	Air flow *2	m ³ /min	3.3-3.5-3.8-4.2	4.0-4.2-4.4-4.7	4.0-4.4-4.9-5.4	4.0-4.6-5.4-6.7	4.3-5.4-6.9-8.4	6.3-7.4-8.6-10.0	6.8-8.3-10.2-12.4
		l/s	55-58-63-70	67-70-73-78	67-73-82-90	67-77-90-112	72-90-115-140	105-123-143-167	113-138-170-207
		cfm	117-124-134-148	141-148-155-166	141-155-173-191	141-162-191-237	152-191-244-297	222-261-304-353	240-293-360-438
Static external press	Pa	0 (0)							
Motor	Type	DC motor							
	Power output	kW	0.03						
Air filter		PP Honeycomb							
Refrigerant pipe diameter	Gas (swaged)	mm	Ø 12.7 (Ø1/2)						
	Liquid (swaged)	mm	Ø 6.35 (Ø1/4)						
Local drain pipe diameter		I.D. 16 (5/8)							
Sound pressure *2 *3	dB(A)	22-24-26-28	22-24-26-28	22-26-29-31	22-27-31-35	24-31-37-41	29-34-37-40	31-36-41-46	

*1 For heating/cooling capacity, the maximum value with the unit operating in the following conditions is given.
Cooling: indoor 27°C (81°F) DB/19°C (66°F) WB, outdoor 35°C (95°F) DB. Heating: indoor 20°C (68°F) DB, outdoor 7°C (45°F) DB/6°C (43°F) WB.
*2 Air flow/noise levels given for operation in low-medium1-medium2-high modes.
*3 Measured in anechoic chamber.



Technical specifications

MODEL			PKFY-P63VKM-E	PKFY-P100VKM-E
Power	A single-phase, 220-230-240VAC 50Hz			
Capacity in cooling mode*1	kW		7.1	11.2
	Btu/h		24200	38200
Capacity in heating mode*1	kW		8.0	12.5
	Btu/h		27300	42600
Power consumption	Cooling	kW	0.05	0.08
	Heating	kW	0.04	0.07
Current	Cooling	A	0.37	0.58
	Heating	A	0.30	0.51
External finish	Munsell plastic 1.0Y 9.2/0.2			
Dimensions HxLxW		mm	365x1170x295	365x1170x295
Net weight		kg	21	21
Heat exchanger	Cross fins (aluminium fins and copper piping)			
Fan	Type x Quantity	Linear flow fan x 1		
	Air flow (low-medium-high)	m ³ /min	16-20	20-26
		l/s	267-333	333-433
		cfm	565-706	706-918
Static external press	Pa	0	0	
Motor	Type			
	Power output	kW	0.056	0.056
Air filter	Polypropylene honeycomb fabric (washable)			
Refrigerant pipe diameter	Gas (swaged)	mm	ø15.88	ø15.88 / 19.05
	Liquid (swaged)	mm	ø9.52	ø9.52
Local drain pipe diameter	I.D. 16 (5/8)			I.D. 16 (5/8)
Sound pressure (low-medium-high)*2		dB(A)	39-45	41-49

*1 For heating/cooling capacity, the maximum value with the unit operating in the following conditions is given.
Cooling: indoor 27°C (81°F) DB/19°C (66°F) WB, outdoor 35°C (95°F) DB. Heating: indoor 20°C (68°F) DB, outdoor 7°C (45°F) DB/6°C (43°F) WB.

*2 Air flow/noise levels given for operation in low-medium1-medium2-high modes, in low-medium-high modes or in low-high modes, depending on model.
Measured in anechoic chamber.

PAC-LV11-E

INDOOR UNITS - Wall-mounted design indoor unit LEV Kit



CITY MULTI

Ideal for...

The new LEV Kit may be used to connect both standard VRF indoor units and Residential line indoor units in the same CITY MULTI VRF system.

The new LEV Kit makes it possible to connect stylish residential indoor units, with looks that are perfectly suited for large installations in applications such as residential buildings and hotels, where design is a decisive factor in the choice of indoor units.





Easy installation and maintenance

The new LEV Kit is easy to install in double ceilings or dedicated niches not only because of its compact size (183 mm H x 355 mm L x 142 mm W), but also and especially because it can be installed vertically or horizontally with no condensate drain.

Additionally, a maximum permissible piping length of 15 m between indoor units and the LEV Kit offers the freedom to install the kit in the most effective position possible.

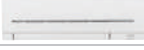
Residential indoor units

The following residential indoor units may be connected to the LEV Kit:





Types and Sizes available Residential indoor units	15	18	20	22	25	35	42	50
MSZ-LN_VG(2) 		•			•	•		•
MSZ-AP_VG(K) 	•		•		•	•	•	•
MSZ-EF_VE/VG 		•		•	•	•	•	•
MSZ-SF_VAVE3 	•		•	•	•	•	•	•
MFZ-KJ_VE 					•	•		•
MFZ-KT_VG 					•	•		•

ATTENTION !!

FOR DETAILS ON COMPATIBILITY BETWEEN EACH MODEL OF INDOOR UNITS AND OUTDOOR UNITS PLEASE CONTACT YOUR LOCAL DISTRIBUTOR

Unparalleled comfort and air quality

The quality of an environment also depends on perceived noise levels. Mitsubishi Electric air conditioners connected to a VRF CITY MULTI system using the LEV Kit offer the highest levels of acoustic comfort available today on the market.

Interior of a train  80dB(A)	Interior of a quiet car (40 km/h)  60dB(A)	Inside a library  40dB(A)	Sound of rustling leaves  22dB(A) SEZ-KD	Limit of human hearing  10dB(A)
---	--	--	--	--

The residential indoor units also contribute to higher air quality levels with the superior filtration power of air filters with nanoplatinum treatment.



Key Technologies

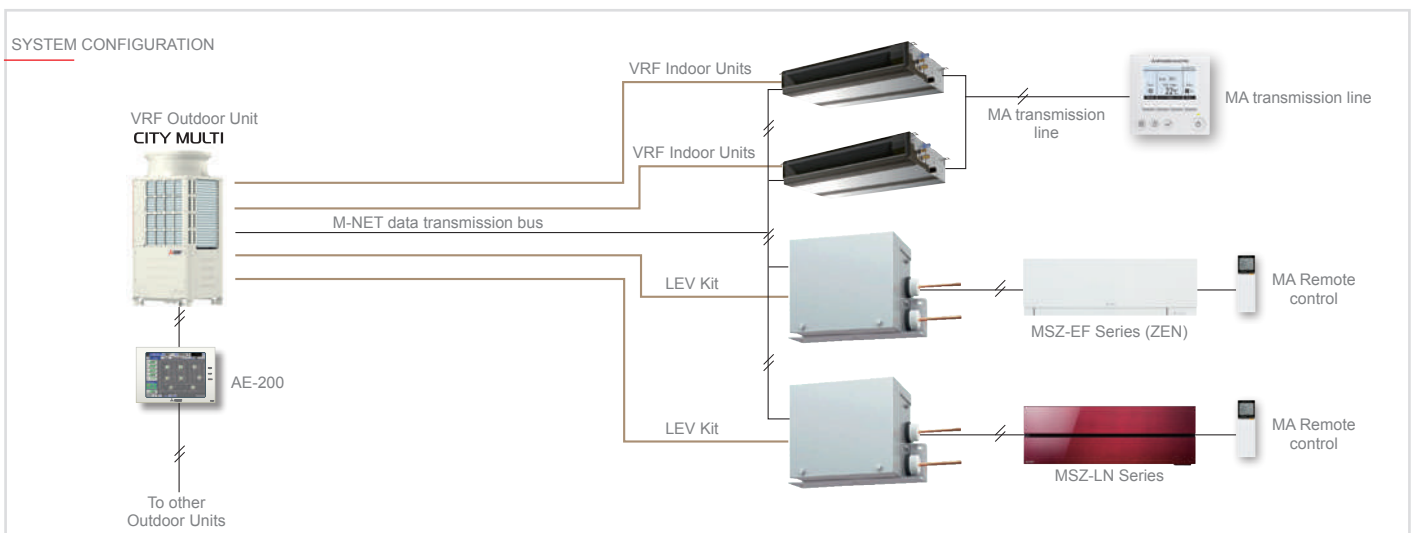

Technical specifications

MODEL			PAC-LV11-E
Power			A single-phase, 220-240VAC 50Hz
Compatible Family series residential indoor units			MSZ-EF, MSZ-LN, MSZ-SF, MSZ-KJ
Number of branches			1 way
Maximum distance between indoor unit and LEV Kit	m		15
Compatible CITY MULTI outdoor units			Small Y Line - Small Y Compact Line - Y Lines (Ecostandard/ Standard Efficiency/High Efficiency) - Y Line Zubadan (YHM) - Y Line Replace Multi (YJM), R2 Lines (Standard Efficiency/High Efficiency) - R2 Line Replace Multi (YJM), WY Line (YHM) - WR2 Line (YHM)
Dimensions (HxLxW)	mm		180x355x142
Net weight	kg		3.5
Condensate drain			Not necessary
Installation			Vertical Horizontal
Refrigeration pipe diameter	Liquid	mm	6.35 (brazed)
	Gas	mm	-
Compatible remote controls			Standard: Remote control included with optional residential indoor units (purchased separately): 1. MA wired remote control interfaced via MAC-397IF board (optional, for installation in indoor units - purchased separately). 2. ME wired remote control, interfaced via LEV Kit terminal board.

PFFY-P VKM-E

INDOOR UNITS - Design floor-standing unit



CITY MULTI

Ideal for...

A high performance floor-standing air conditioner unit with an **elegant design** for lounges, bedrooms or offices where style is imperative.

Sophisticated design

A floor-standing air conditioner unit by Mitsubishi Electric boasting an innovative design and combining simple, linear lines with a wide choice of functions. Conceived to leave the walls free, a unit that delivers comfortable cooling performance in summer and pleasant heat in winter. The gloss pure white finish lends the unit a premium look suitable for any interior space. Both the upper and lower air vents are closed when the air conditioner is switched off, giving the unit an elegantly stylish feel. A beautifully stylish and innovative air conditioner from Mitsubishi that suits your most elegant interior spaces to perfection.

Slim but powerful

The slimline housing of the unit expresses the essence of compactness. The ideal size for a lounge, bedroom and many other rooms. The front panel is removable and washable, making the unit extremely simple to clean. Cleaning your air conditioner simply and regularly will keep it looking great and working perfectly for maximum energy efficiency.

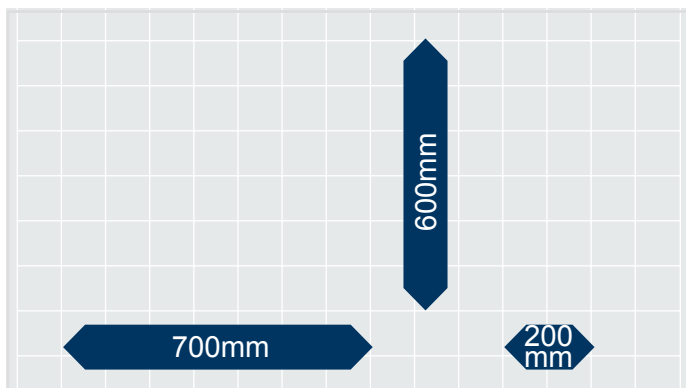

Ideal air distribution

Air is distributed powerfully and effectively via the upper and lower air vents, ensuring a comfortable temperature throughout the room. The angle of the upper vent is settable into 5 different positions (+ swing and automatic modes) from a remote control, while 4 different air speed settings are available. Setting the vane to an almost vertical position prevents undesirable draughts, for even greater comfort.



The air delivered from the upper and lower vents is controlled for optimum comfort and distributed evenly into every corner of the room. In heating mode, the warm air flow is controlled intelligently to reach floor level, making cold feet a thing of the past!

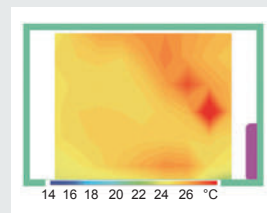



Key Technologies

Technical specifications

MODEL			PFFY-P20VKM-E	PFFY-P25VKM-E	PFFY-P32VKM-E	PFFY-P40VKM-E
Power			A single-phase, 220-240V 50Hz			
Capacity in cooling mode*1		kW	2.2	2.8	3.6	4.5
		Btu/h	7500	9600	12300	15400
Capacity in heating mode*1		kW	2.5	3.2	4.0	5.0
		Btu/h	8500	10900	13600	17100
Power consumption	Cooling	kW	0.025	0.025	0.025	0.028
	Heating	kW	0.025	0.025	0.025	0.028
Current	Cooling	A	0.20	0.20	0.20	0.24
	Heating	A	0.20	0.20	0.20	0.24
External finish			Plastic (pure white)			
Dimensions HxLxW		mm	600x700x200	600x700x200	600x700x200	600x700x200
Net weight		kg	15	15	15	15
Heat exchanger			Cross fins (aluminium fins and copper piping)			
Fan	Type x Quantity		Linear flow fan x 2			
	Air flow (low-medium-high-extra high)	m ³ /min	5.9-6.8-7.6-8.7	6.1-7.0-8.0-9.1	6.1-7.0-8.0-9.1	8.0-9.0-9.5-10.7
	Static external pres.	Pa	0	0	0	0
Motor	Type		DC motor			
	Power output	kW	0.03x2	0.03x2	0.03x2	0.03x2
Air filter			Polypropylene honeycomb fabric (catechin filter)			
Refrigerant pipe diameter	Gas (swaged)	mm	ø12.7	ø12.7	ø12.7	ø12.7
	Liquid (swaged)	mm	ø6.35	ø6.35	ø6.35	ø6.35
Local drain pipe diameter			D.I. 16 (PVC pipe connectable to VP-16)			
Sound pressure (low-medium-high)*2		dB(A)	27-31-34-37	28-32-35-38	28-32-35-38	35-38-42-44

*1 For heating/cooling capacity, the maximum value with the unit operating in the following conditions is given.

Cooling: indoor 27°C (81°F) DB/19°C (66°F) WB, outdoor 35°C (95°F) DB. Heating: indoor 20°C (68°F) DB, outdoor 7°C (45°F) DB/6°C (43°F) WB.

*2 Measured in anechoic chamber.

PFFY-P VEM-E NEW

INDOOR UNITS - Design floor-standing unit



New design

The new sophisticated design in clear white and pearl grey blends in with any interior. With a depth of 217 mm, the compact unit is ideal for installation in the perimeter zone of a room.

Three installation options are available to suit a wide range of applications.



INSTALLATION OPTIONS

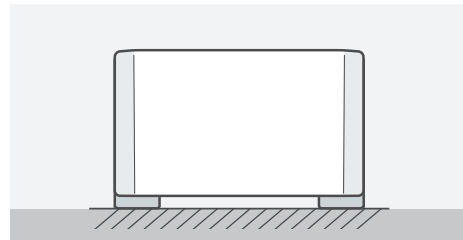

Floorstanding
Conventional floorstanding
installation is possible.

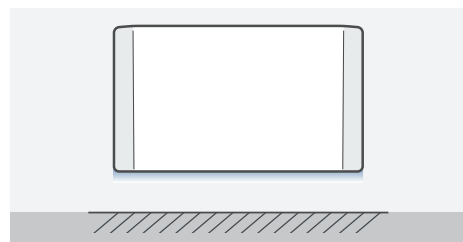

Wall-mounted
Wall-mounted installation
allows for a stylish interior
design.

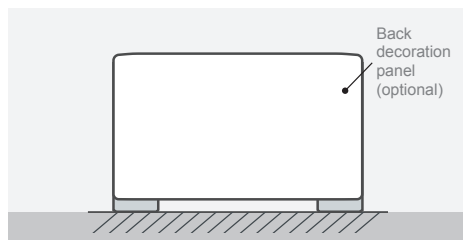

Freestanding
With the optional back decoration
panel, the unit can be
installed away from the wall for
more design flexibility.

Reduced power consumption and noise

PFFY-P VEM-E features new components and an optimized structure for more efficient and comfortable operation.

- A high-efficiency DC fan motor is equipped.
- The inner pipes of the heat exchanger have been downsized from $\varnothing 9.52$ to $\varnothing 7.0$ to fit in more pipings.
- The new structure realizes smooth airflow and reduces pressure loss in the air pathway.

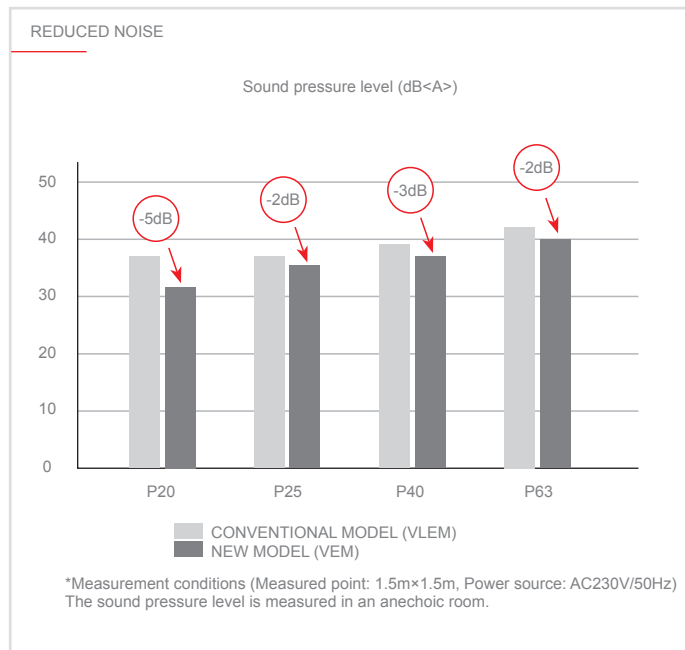
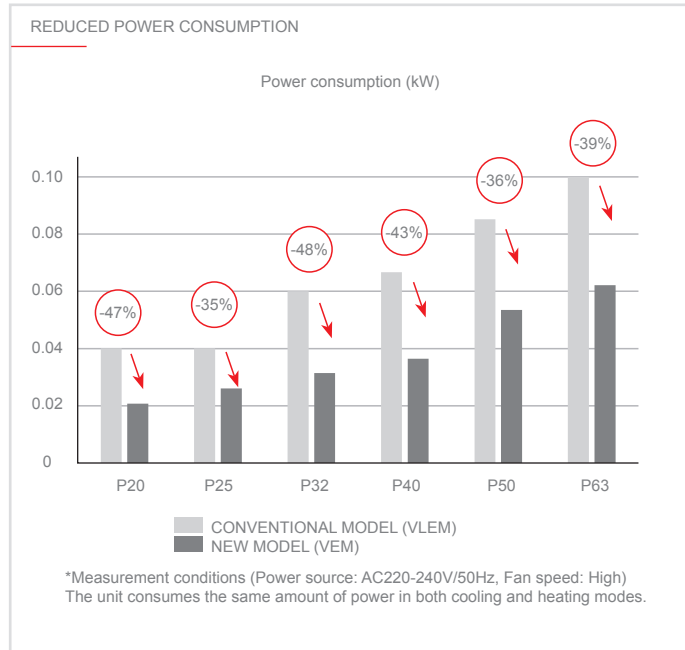

Flexible airflow rate setting

Airflow rate can be set to three levels to suit various installation conditions and maintain a comfortable room temperature.

Airflow rate setting	Model	Airflow rate
New	PFFY-P VEM	Low-Mid-High
Conventional	PFFY-P VLEM	Low-High

REMOTE CONTROLLER STORAGE IN THE MAIN UNIT

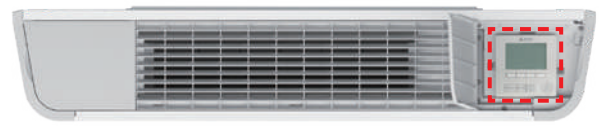

MA remote controller can be stored on the right side of the main unit.

Easy maintenance

The air filter can be easily removed from the front bottom of the unit for regular cleaning.



Optional parts	Model	Remarks
Back decoration panel*	PAC-BP32VEM-E	For PFFY-P20, 25, 32VEM-E
	PAC-BP50VEM-E	For PFFY-P40, 50VEM-E
	PAC-BP63VEM-E	For PFFY-P63VEM-E

*The back decoration panel is required for freestanding installation. When it is attached to the main unit, the pipes must run under the floor. Please contact Italian Branch for availability

BACK DECORATION PANEL



Key Technologies

Specifications

MODEL		PFFY-P20VEM-E	PFFY-P25VEM-E	PFFY-P32VEM-E	PFFY-P40VEM-E	PFFY-P50VEM-E	PFFY-P63VEM-E	
Power source		1-phase 220-230-240 V 50/60 Hz						
Cooling capacity (Nominal) ^{*1}	kW	2.2	2.8	3.6	4.5	5.6	7.1	
	Btu/h	7500	9600	12300	15400	19100	24200	
Heating capacity (Nominal) ^{*2}	kW	2.5	3.2	4.0	5.0	6.3	8.0	
	Btu/h	8500	10900	13600	17100	21500	27300	
Power input	Cooling kW	0.021	0.026	0.031	0.037	0.054	0.061	
	Heating kW	0.021	0.026	0.031	0.037	0.054	0.061	
Current input	Cooling A	0.26-0.25-0.24	0.31-0.30-0.29	0.37-0.35-0.34	0.39-0.38-0.36	0.58-0.56-0.55	0.52-0.50-0.48	
	Heating A	0.26-0.25-0.24	0.31-0.30-0.29	0.37-0.35-0.34	0.39-0.38-0.36	0.58-0.56-0.55	0.52-0.50-0.48	
External finish		Galvanized steel plate, MUNSELL (1.0Y 9.2/0.2)/ABS, MUNSELL (5.32GY 8.75/0.37)						
External dimension H x W x D ^{*3}	mm	669(726)x1142x217	669(726)x1142x217	669(726)x1142x217	669(726)x1342x217	669(726)x1342x217	669(726)x1542x217	
Net weight	kg	29.5	29.5	30	35	35	39.5	
Heat exchanger		Cross fin (Aluminum fin and copper tube)						
FAN	Type x Quantity	Sirocco fan x 2	Sirocco fan x 2	Sirocco fan x 2	Sirocco fan x 3	Sirocco fan x 3	Sirocco fan x 4	
	Air flow rate	m ³ /min	5.0 - 6.0 - 7.0	5.5 - 6.5 - 8.0	5.5 - 7.0 - 8.5	8.0 - 9.5 - 11.0	10.0 - 11.5 - 13.5	12.0 - 14.0 - 16.5
		l/s	83 - 100 - 117	92 - 108 - 133	92 - 117 - 142	133 - 158 - 183	167 - 192 - 225	200 - 233 - 275
	cfm	177 - 212 - 247	194 - 230 - 282	194 - 247 - 300	282 - 335 - 388	353 - 406 - 477	424 - 494 - 583	
External static press.	Pa	0	0	0	0	0	0	
Motor	Type	DC motor						
	Output kW	0.096						
Air filter		PP honeycomb fabric.						
Refrigerant piping diameter	Gas (R410)	mm	12.7 (1/2) Brazed	12.7 (1/2) Brazed	12.7 (1/2) Brazed	12.7 (1/2) Brazed	15.88 (5/8) Brazed	
	Liquid (R410)	mm	6.35 (1/4) Brazed	6.35 (1/4) Brazed	6.35 (1/4) Brazed	6.35 (1/4) Brazed	9.52 (3/8) Brazed	
Field drain pipe size		O.D.32 (1-1/4)						
Sound pressure level	dB(A)	23.0-27.0-31.0	25.0-29.0-34.0	25.0-31.0-36.0	29.0-33.0-36.0	34.0-37.0-41.0	32.0-36.0-40.0	

1. Nominal cooling conditions

Indoor: 27° CD.B./19° CW.B. (81° FD.B./66° FW.B.), Outdoor: 35° CD.B. (95° FD.B.), Pipe length: 7.5 m (24-9/16 ft.), Level difference: 0 m (0 ft.)

2. Nominal heating conditions

Indoor: 20° CD.B. (68° FD.B.), Outdoor: 7° CD.B./6° CW.B. (45° FD.B./43° FW.B.), Pipe length: 7.5 m (24-9/16 ft.), Level difference: 0 m (0 ft.)

3. The values in () show the height of unit with leg.

* Details on foundation work, duct work, insulation work, electrical wiring, power source switch, and other items shall be referred to the Installation Manual.

* Due to continuing improvement, above specifications may be subject to change without notice.

**WHAT'S
NEW**

What has changed on PFFY-M VEM-E Design floor-standing units?

- New design and chassis and dimension
- Added the possibility to installation freestanding
- Three levels of Air flow rate
- Reduced noise



PFFY-P VCM-E

INDOOR UNITS - Floor standing concealed

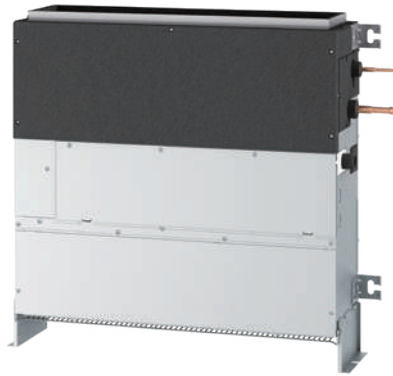

CITY MULTI

Ideal for...

Built-in floor units: simplified installation for effective air conditioning performance.

Flexible air-flow and external static pressure setting

The VCM series may be configured with a choice of four different static external pressure settings: 0, 10, 40 and 60 Pa. Besides airflow rate can be selected from 3 patterns (Low-Mid-High).

Reduced power consumption and noise

New structure realizes smoother airflow to reduce pressure loss in air pathway. The combination of an improved air pathway structure and components contributes to reduce power consumption and operation noise.

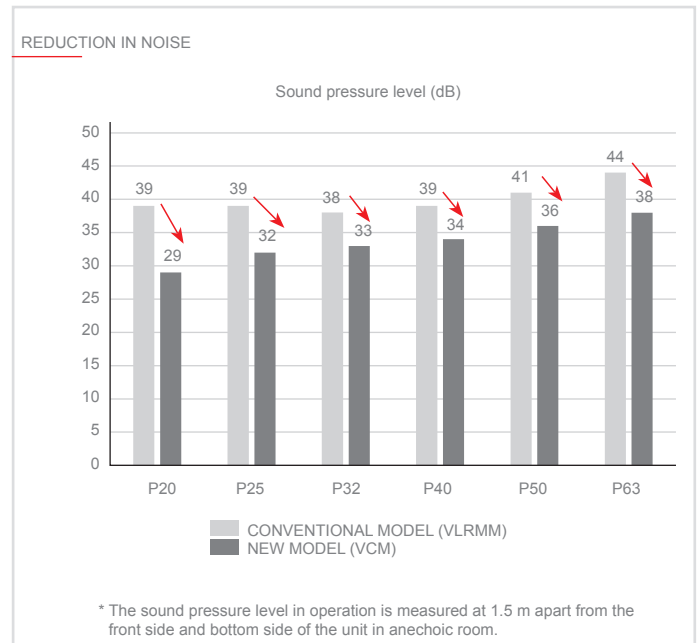
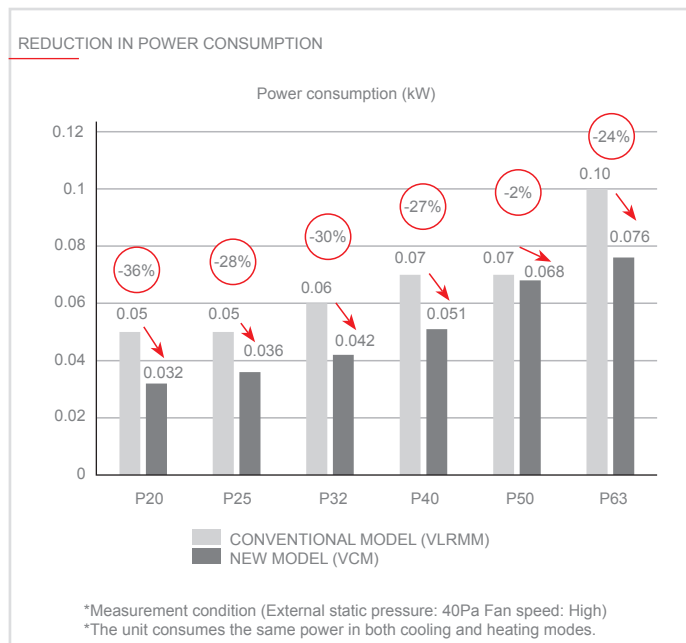



Key Technologies VCM

FLEXIBLE INSTALLATION

Selectable air inlet pattern

It is selectable bottom suction or front suction by changing panel, fan guard and filter.

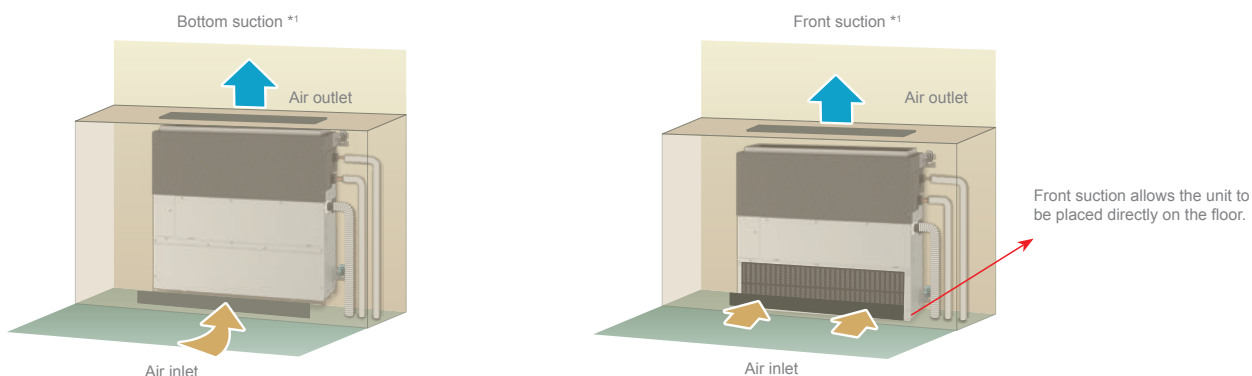

*1 Select a site where the flow of supply and air is not blocked. This unit cannot be placed directly on the floor with bottom suction.
 *2 Unit with front suction makes noise than that with bottom suction. It is recommended that the bottom suction to be selected when installing the units in rooms that should be quiet, such as bedrooms.

Floor-standing with legs

The unit can be placed on the floor with the supplied legs.

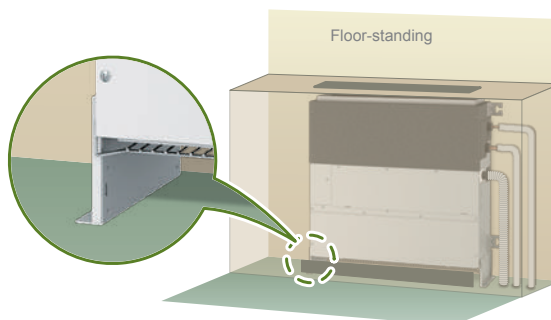

*Height of unit (with legs) is 690 mm.

Technical specifications

MODEL			PFFY-P20VCM-E	PFFY-P25VCM-E	PFFY-P32VCM-E	PFFY-P40VCM-E	PFFY-P50VCM-E	PFFY-P63VCM-E	
Power	A single-phase, 220-240V, 50Hz / a single-phase, 208-230V, 60Hz								
Capacity in cooling mode*1	kW		2.2	2.8	3.6	4.5	5.6	7.1	
	Btu/h		7,500	9,600	12,300	15,400	19,100	24,200	
Capacity in heating mode*1	kW		2.5	3.2	4.0	5.0	6.3	8.0	
	Btu/h		8,500	10,900	13,600	17,100	21,500	27,300	
Power consumption*2	Cooling	kW	0.022	0.026	0.031	0.038	0.052	0.058	
	Heating	kW	0.022	0.026	0.031	0.038	0.052	0.058	
Current*2	Cooling	A	0.25	0.30	0.34	0.38	0.50	0.49	
	Heating	A	0.25	0.30	0.34	0.38	0.50	0.49	
External finish	Galvanized steel plate								
Dimensions HxLxW*3	mm		615(690)x700x200	615(690)x700x200	615(690)x700x200	615(690)x900x200	615(690)x900x200	615(690)x1,100x200	
Net weight	kg		18	18	18.5	22.5	22.5	25.5	
Heat exchanger	Cross fin (aluminium fin and copper piping)								
Fan	Type x Quantity		Sirocco x 2	Sirocco x 2	Sirocco x 2	Sirocco x 3	Sirocco x 3	Sirocco x 4	
	Air flow	(Low-Mid-High)							
		m ³ /min		5.5-6.0-7.0	5.5-6.5-8.0	5.5-7.0-8.5	8.0-9.5-11.0	10.0-11.5-13.5	12.0-14.0-16.5
		l/s		83-100-117	92-108-133	92-117-142	133-158-183	167-192-225	200-233-275
cfm		177-212-247	194-230-282	194-247-300	282-335-388	353-406-477	424-494-583		
Static external pres.	Pa	<0> - 10 - <40> - <60>	<0> - 10 - <40> - <60>	<0> - 10 - <40> - <60>	<0> - 10 - <40> - <60>	<0> - 10 - <40> - <60>	<0> - 10 - <40> - <60>	<0> - 10 - <40> - <60>	
Motor	Type	DC motor							
	Power output	kW	0.096	0.096	0.096	0.096	0.096	0.096	0.096
Air filter	Polypropylene honeycomb fabric (washable)								
Refrigerant pipe diameter	Gas (brazed)	mm	ø12.7	ø12.7	ø12.7	ø12.7	ø12.7	ø15.88	
	Liquid (brazed)	mm	ø6.35	ø6.35	ø6.35	ø6.35	ø6.35	ø9.52	
Field drainpipe diameter	O.D. 32 (1-1/4)								
Sound pressure*2	dB(A)		21-23-26	22-25-29	23-26-30	25-27-30	28-31-34	28-32-35	

*1 For heating/cooling capacity, the maximum value with the unit operating in the following conditions is given.

Cooling: indoor 27°C (81°F) DB/19°C (66°F) WB, outdoor 35°C (95°F) DB. Heating: indoor 20°C (68°F) DB, outdoor 7°C (45°F) DB/6°C (43°F) WB.

*2 The values are measured at the factory setting of external static pressure (10 Pa).

*3 The values in () show the height of unit with leg.





HVRF hydronic systems

Y Line

R32 HVRF Packaged Hydronic systems Heat Pump

The HVRF Y packaged hydronic system is a new hydronic solution on heat pump version that consists of a water production section composed of a VRF technology Outdoor Unit Y CITY MULTI and a hydronic unit for water distribution. The system is completed by different types and sizes of hydronic terminals, that can be regulated locally. All components of the hydronic system are branded Mitsubishi Electric. HVRF hydronic systems are derived from VRF and as such bring with them the advantages of a simplified design and sizing defined by Mitsubishi Electric rules. HVRF Y systems are environmentally friendly with an important reduction of CO₂ equivalent, thanks to the use of R32 refrigerant gas, with low GWP.



HVRF Y LINE

HYDRONIC UNIT

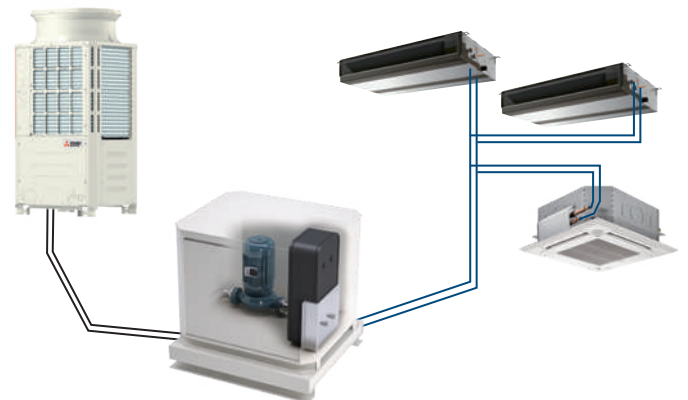



R2/WR2 Line

R410A HVRF packaged hydronic heat pump systems

The HVRF R2 packaged hydronic heat recovery system is a technology based on Mitsubishi Electric's CITY MULTI R2 two-pipe system for simultaneous cooling and heating with heat recovery.

It consists of an R2 (or WR2) outdoor unit of the CITY MULTI series, the innovative Hydronic BC (HBC) distributor which allows the use of refrigerant gas and water as refrigerator fluids, as well as indoor units specially equipped with a water coil.

HVRF hydronic systems are derived from VRF and as such bring with them the advantages of a simplified and guided design in the sizing of all components.



The use of hydronic distribution allows for an up to 45% reduction in refrigerant compared to a traditional VRF system. HVRF R2 systems have a low environmental impact with an important reduction in CO₂ equivalent.

HVRF R2 LINE

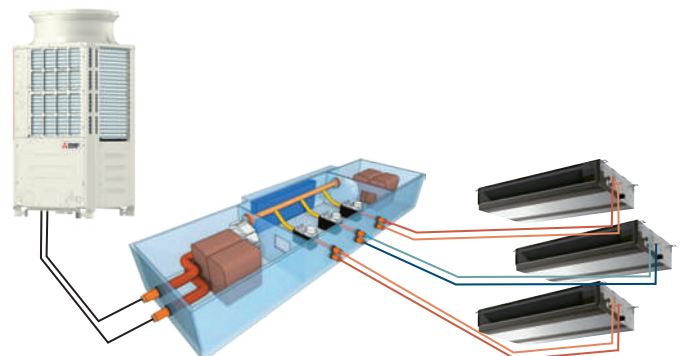

HYDRONIC HBC CONTROLLER



	CITY MULTI Y SYSTEMS	Heat pump systems with continuous heating
	CITY MULTI R2 SYSTEMS	Simultaneous two-pipe cooling/heating systems with heat recovery and continuous heating.
	CITY MULTI WR2 SYSTEMS	Heat recovery systems with water condensation/evaporation.

Outdoor units	8	10
	M200	M250
Model	WM250	
HYDRONIC UNIT CMH-WM V-A		
	same external dimensions/different internal structures depending on capacity	

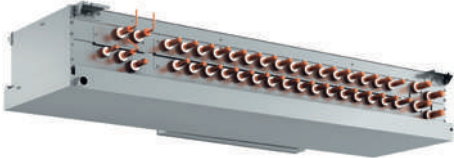
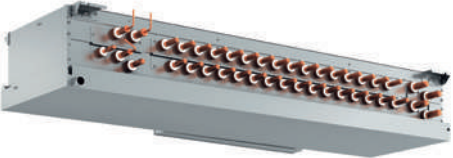
Type of HBC	Main	
Model	CMB-WM108V-AA	CMB-WM1016V-AA
Number of connections	8	16
HYDRONIC BC CONTROLLER HBC		

	<p>SINGLE Y PUHY-M YNW-A1 (-BS) - HP 8~20</p>
	<p>SINGLE R2 PURY-P YNW-A2(-BS) - HP 8~20</p>
	<p>SINGLE WR2 PQRY-P YLM-A1 - HP 8~20</p>

12	14	16	18	20
M300	M350	M400	M450	M500
WM350			WM500	
				
<p>same external dimensions/different internal structures depending on capacity</p>				

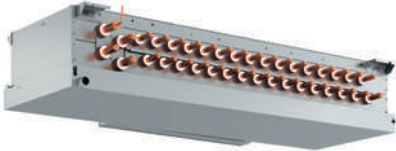
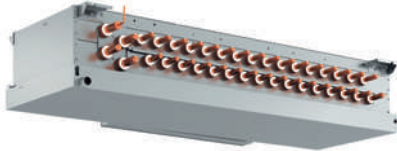
Sub	
CMB-WM108V-BB	CMB-WM1016V-BB
8	16
	

Sistem					HP	4,5	
					Model	P112	
Air-cooled	HVRF Heat pump	Y Line Heat Pump	PUHY-M YNW-A1 (-BS)		SINGLE		
					DOUBLE		
					TRIPLE		
	HVRF Heat recovery	R2 Line Heat Pump	PURY-P YNW-A2(-BS)		SINGLE		
					DOUBLE		
Water-cooled	HVRF Heat recovery	WR2 Line Heat recovery	PQRY-P YLM-A1		SINGLE		
					DOUBLE		

	5	6	8	10	12	14	16	18	20
	P125	P140	P200	P250	P300	P350	P400	P450	P500
			8	10	12	14	16	18	20
			8	10	12	14	16	18	20
			8	10	12	14	16	18	20



Key Technologies

Mitsubishi Electric: state of the art technology and continuous pursuit of improvement. Quality, innovation and performance of HYDRONIC VRF CITY MULTI systems.

Technology



Lower concentration of GAS

Lower concentration of refrigerant in the building and confined only in the section between the Outdoor Unit and the Hydronic Unit/Hydronic Branch Controller.



High SHF (Sensible Heat Factor) cooling

Thanks to HYDRONIC VRF technology it is possible to design systems with typical VRF simplicity and higher comfort thanks to the use of water as heat carrier. Mitsubishi Electric water-fed indoor units grant a really stable temperature control, with higher Sensible Heat Factor (SHF) than traditional direct expansion systems.

Reduced defrost and transitory time



Using water as heat carrier also gives an additional advantage during heating periods, reducing defrost time. Thanks to water thermal inertia it is possible to resume releasing heat to the environment just after a defrost cycle, minimizing the system turn-off periods.



Silent functioning with water cooled units

Indoor units of the HYDRONIC VRF are equipped with water-fed heat exchangers. The lack of LEV valve in the units grants a very silent functioning regime, particularly suited for “sensible” environments such as libraries, schools, bedrooms.



Modular system for fractionate and progressive installation

HYDRONIC VRF system is particularly suited for designs which require partial installation or applications characterized by fractionated realization schedule. This often occurs in real-estate of commercial/residential buildings intended for different type of users, which are often sold/realized separately.



Modulating regulation thanks to the pumps and valves based on the load and capacity required

The new HYDRONIC VRF system contains all the components necessary for the distribution and regulation typical of a hydronic system. Thanks to the presence of two Pumps and valve blocks, the HVRF system is able, in total autonomy, to regulate the flow of water destined for the individual hydronic units (indoor units) according to the thermal load required by the individual rooms.

M-NET control system



Being part of the CITY MULTI family, even the HYDRONIC VRF system can use the control and communication systems (M-Net) of the VRF systems and consequently can benefit from the M-NET Power function which allows the system to continue to operate normally even in the event of a power failure of one or more indoor units. This function is particularly advantageous and effective in all those cases in which the air conditioning system is shared between several users (shopping centre, condominium, etc.).



Valves, pumps, exchangers and integrated control and regulation systems

The innovative HYDRONIC VRF distributor is the only device in the world that uses refrigerant gas and water as carrier fluids thanks to special plate heat exchangers. Inside it there are all the components necessary for the distribution and regulation of the water flow to the individual indoor units. The presence of two plate heat exchangers allows the system to always be ready to produce hot and cold water at the same time; supply and return manifolds, water flow regulation valves and two variable flow pumps allow the system to independently manage the hydronic distribution to the individual indoor units based on a complex series of parameters acquired by the same system.



Accessories and safety devices

When installing the HYDRONIC VRF system, it will be sufficient to provide for:

- 20 mm diameter copper or multilayer piping
- Expansion vessel to be connected directly to the HBC Controller
- Supply line (water load) equipped with shut-off valve, safety valve, filter, pressure reducer
- Condensate drain line
- 220V power supply line

Compressor NEXT STAGE GENERATION

The compressor, known as the heart of the air conditioner, has been newly developed. A new centrifugal force canceling mechanism and a new multi-port mechanism have been developed. In addition, we have mounted a high-efficiency motor. The synergetic effect of these new technologies increases the compressor performance and efficiency, and also helps to improve the performance of the outdoor unit.



Centrifugal force canceling mechanism (8 to 14HP)

The structure of the scroll compressor causes a centrifugal force during operation. Conventionally, that centrifugal force is applied onto the scroll section. This causes refrigerant to leak, and restricts the increase in rotational speed to a maximum of 120rps. With the new compressor, a new structure (centrifugal force canceling mechanism) has been mounted to suppress the centrifugal force. This mechanism successfully suppresses the centrifugal force generated at the scroll section, reduces refrigerant leakage losses, and increases the compressor efficiency. The maximum rotational speed has been increased from the conventional 120rps to 140rps.

This new mechanism also speeds up the start of operation, and enables operations such as preheat defrost operation and the smooth auto-shift startup mode.

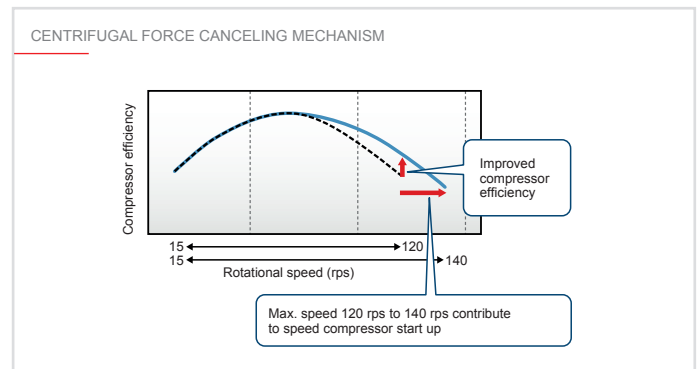
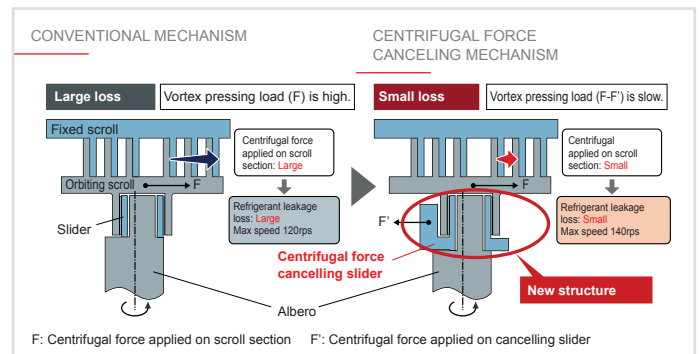

Multi-port mechanism

Efficient partial load operation is realised by avoiding over-compression. With the scroll compressor, the distance of the compression process in the scroll is usually fixed, so over-compression occurs during low loads and low rotation. The new compressor is equipped two sub-ports in addition to the conventional discharge port to reduce this over-compression loss during low loads. In operation conditions having a low compression rate, the distance in the compression process is kept short by that successfully avoiding unnecessary compression, and contributing to efficient partial load operation.

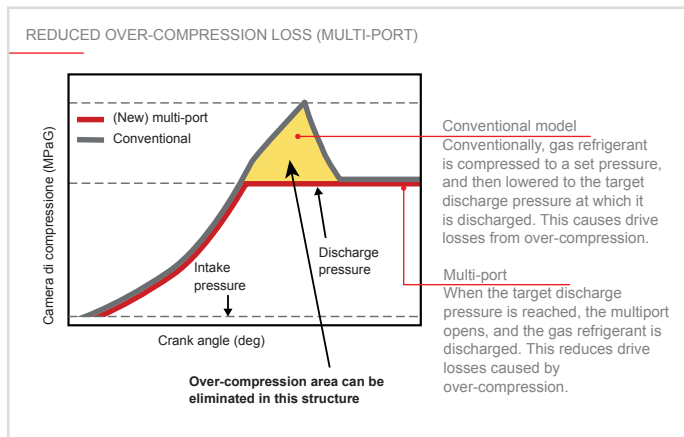
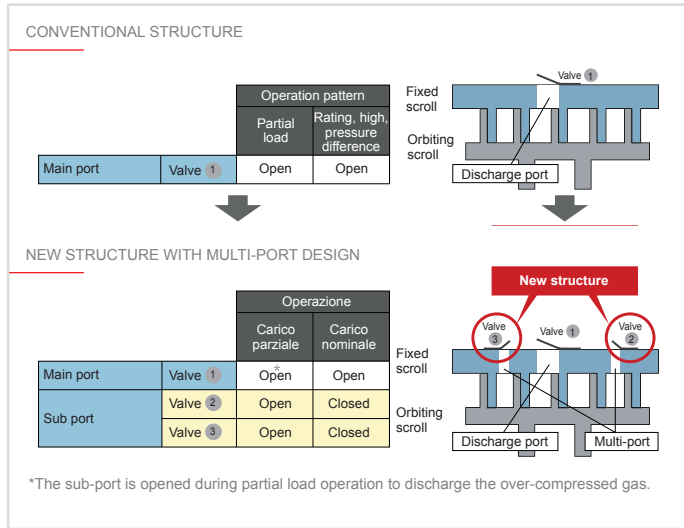

Improved high-efficiency motor

The insulator section that traditionally created a dead space is eliminated by insulating the motor's stator film. Since winding can be set in that section, the winding area can be increased by approx. 9%. The wire diameter has also been increased by two ranks, so the resistance between terminals is reduced, and the insulation distance is shorter. This improves the motor's operation performance and contributes to high-efficiency operation of the compressor.

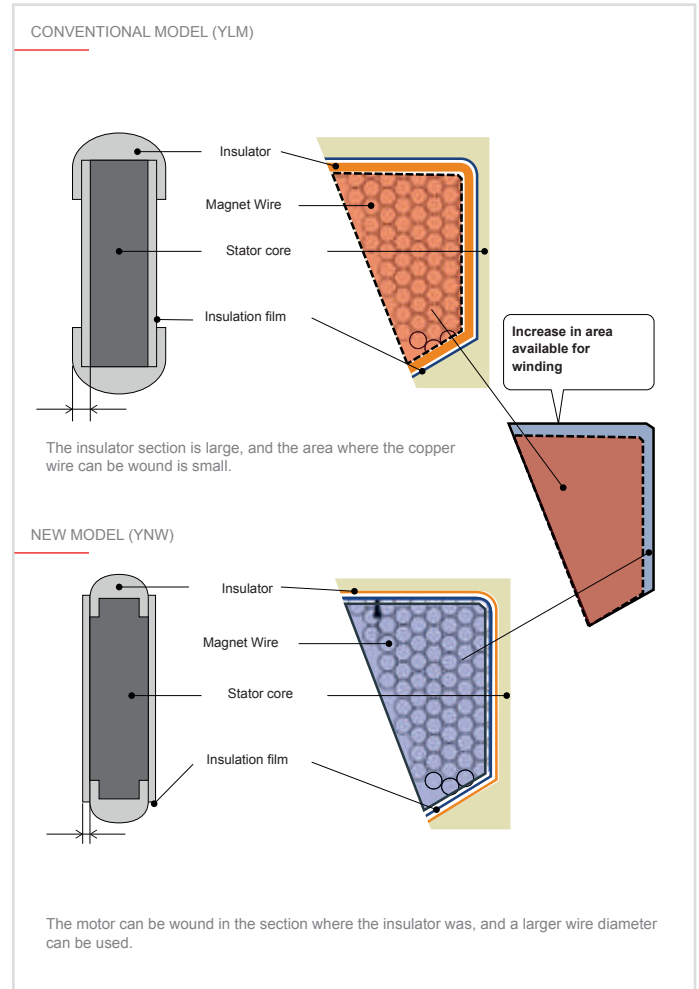



Inverter-driven compressor technology

All CITY MULTI compressors are of the inverter-driven type, capable of precisely matching a building's cooling and heating demands.

The compressor varies its speed to match the indoor cooling or heating demand and therefore only consumes the energy that is required. When an inverter driven system is operating at partial load, the energy efficiency of the system is significantly higher than that of a standard fixed speed, non-inverter system.

The fixed speed system can only operate at 100%, however, partial load conditions prevail for the majority of the time. Therefore, fixed speed systems cannot match the annual efficiencies of inverter driven systems. Using proven single inverter driven compressor technology, the CITY MULTI range is favored by the industry for low starting currents (just 8 amps for a 20HP outdoor unit) and smooth transition across the range of compressor frequencies.

HEATING / COOLING CAPACITY

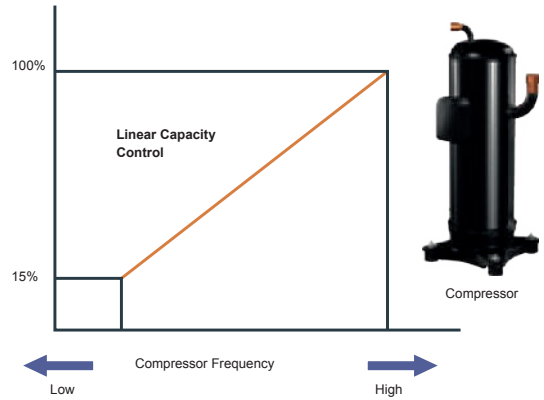

STABLE AND SMOOTH OPERATION

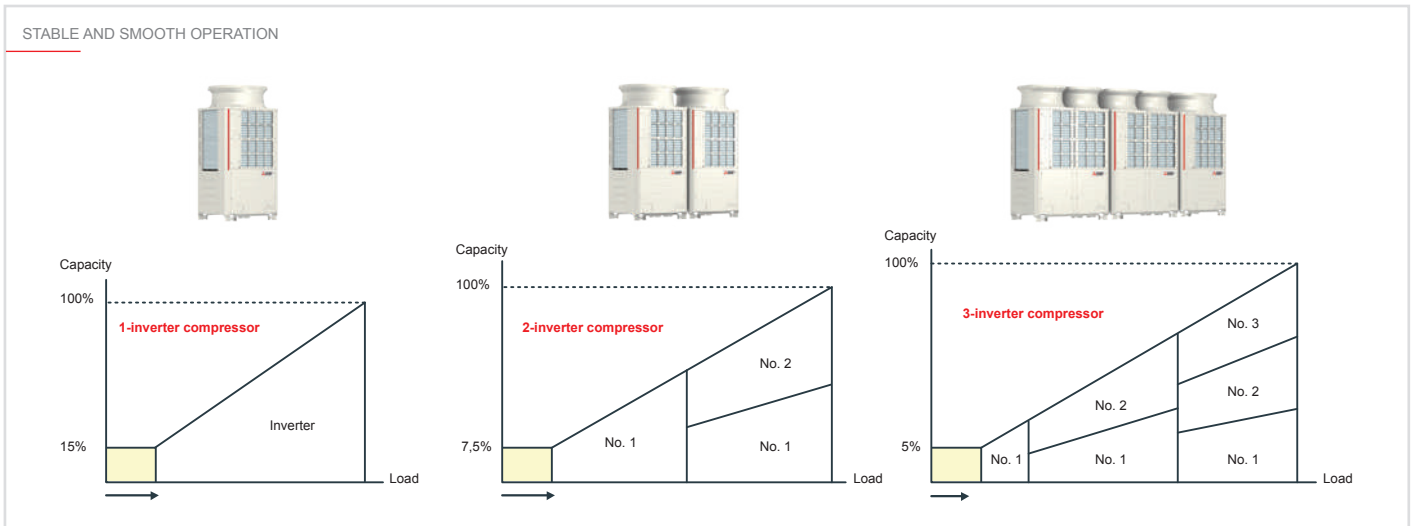

Functions

M-Net Power

With the M-Net transmission line and the use of separate power and control circuits for indoor units, the following states can be identified automatically:

- indoor unit malfunction
- power loss to indoor unit

In the event of one of these conditions, the outdoor unit isolates the malfunctioning indoor unit or indoor unit receiving no power to ensure the continued electrical and refrigeration functionality of the system with no action required from a technician and/or a system administrator. This allows total flexibility in planning and laying out 220V AC power circuits, without the need for shared main lines and without requiring any additional devices to attain compliance with legislation for electrical systems. This circuit configuration is essential for situations where the system itself is shared by multiple owners or tenants, and where each must be able to electrically isolate their respective indoor terminal sections when required.

Continuous operation

In the event of power loss or partial malfunction of one or more indoor units, the system continues to function uninterruptedly and without requiring any action from a technician and/or system administrator.

Continuous heating operation

Normally, it is necessary to stop the heating operation during defrosting. However, the continuous heating operation method makes it possible to perform defrosting while the heating operation continues. Reduction in the stoppage time of the heating operation

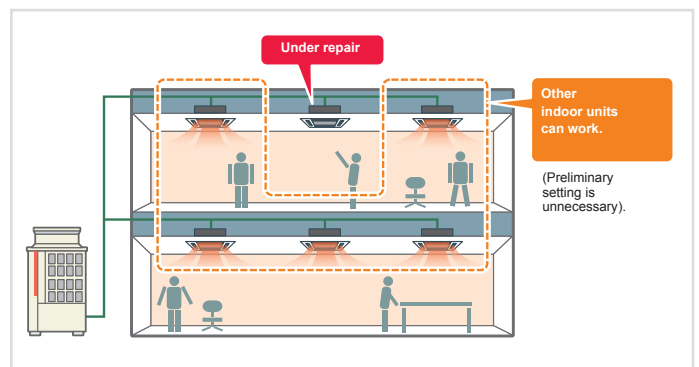
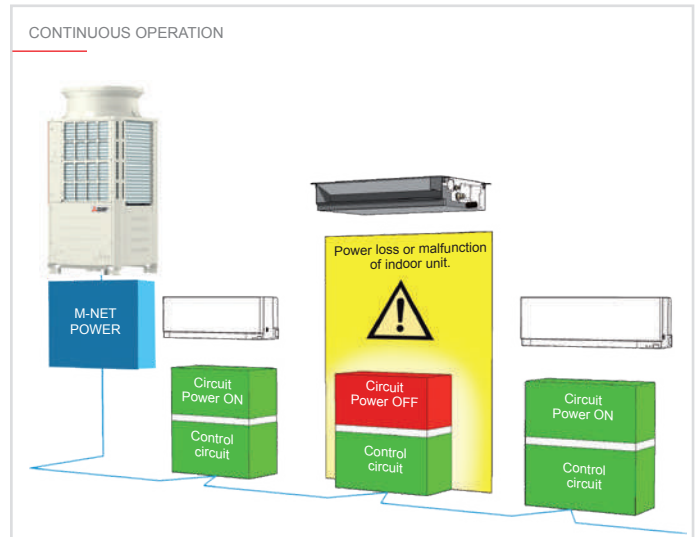

prevents drops in room temperature. Use a dip switch on the outdoor unit to switch between the continuous heating operation method and the conventional defrosting method.

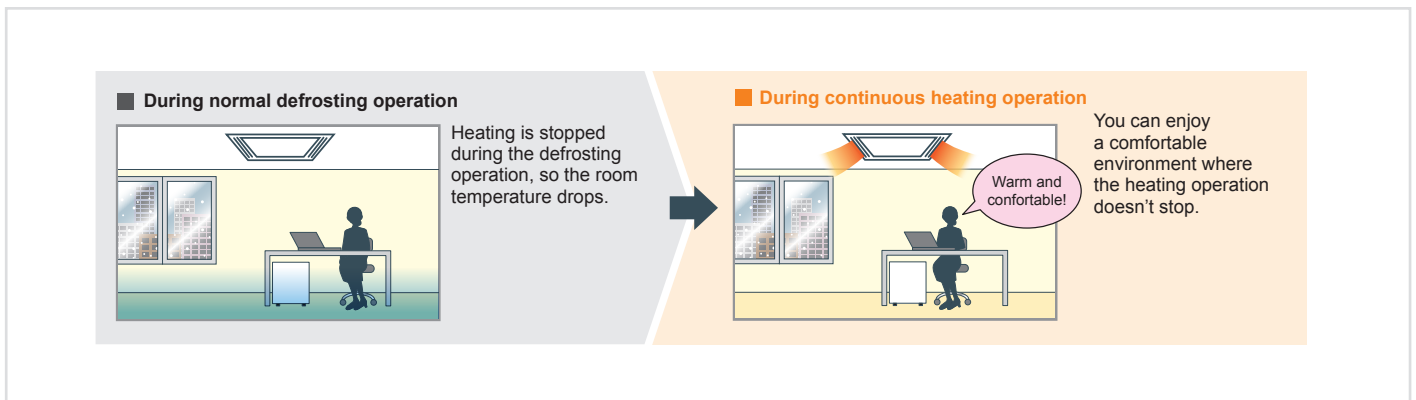

Continuous heating operation image (single unit)

The heat exchanger of the outdoor unit is split into parts. Even when defrosting is necessary, the heating operation is continued with a part of the heat exchangers.

Continuous heating operation image (combination)

With the combination model, units perform defrosting alternately. While one unit is performing defrosting, the other continues heating.

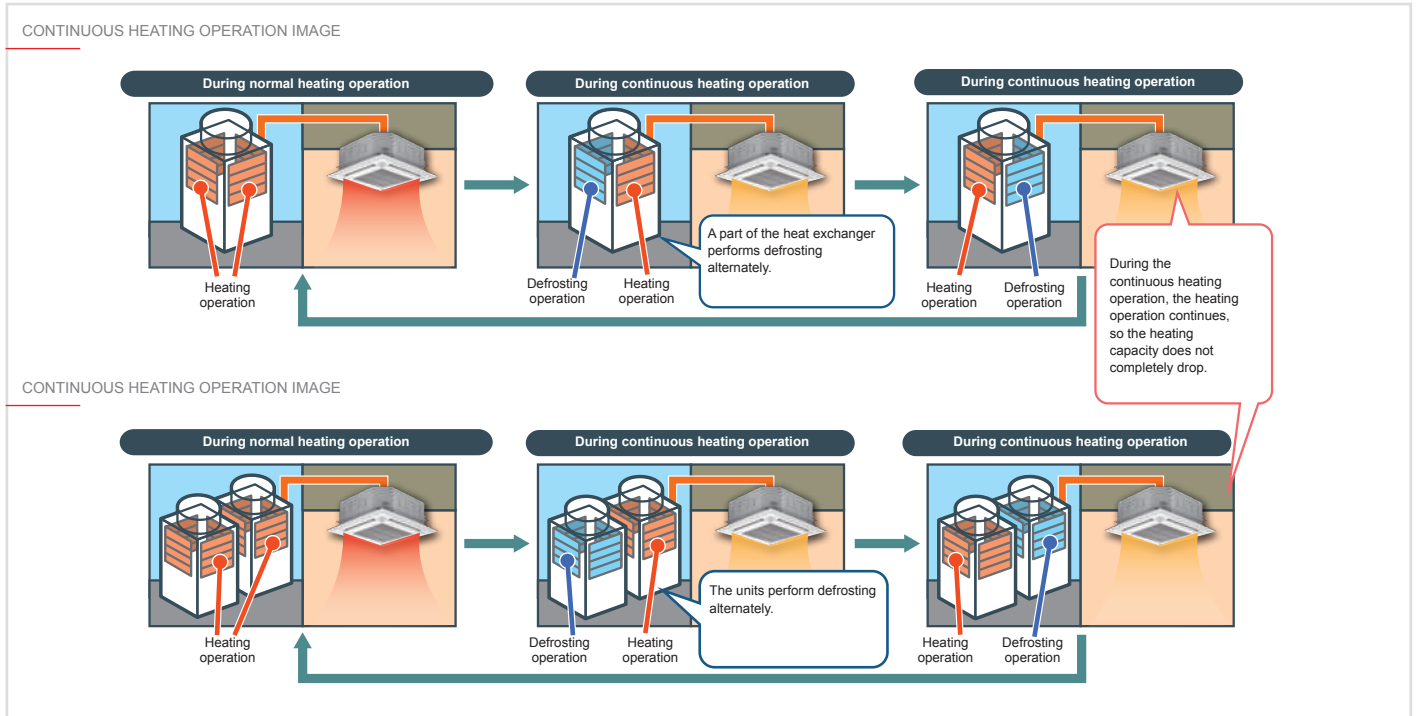

NEW Preheat Defrost Preheat defrost operation

The new outdoor unit is equipped with a preheat defrost operation that raises the discharge temperature of the air before beginning defrost operation. This contributes to raising the room temperature before the start of defrost operation and prevents room occupants experiencing a chilling sensation.

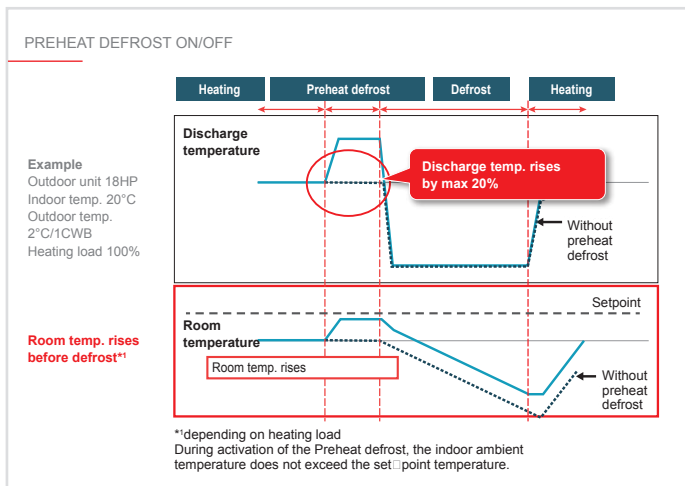

NEW Low Noise Flexible Noise Setting

The "Low Noise" mode, which conventionally only had one pattern, has been increased to four patterns so that a mode can be selected from a total of five patterns, including the rated pattern. The low-noise mode has four patterns 85%, 70%, 60% and 50% in respect to the fan speed. This can be set with the outdoor unit's DIP switch. The pattern can be selected according to the customer's requests when low-noise operation is required.

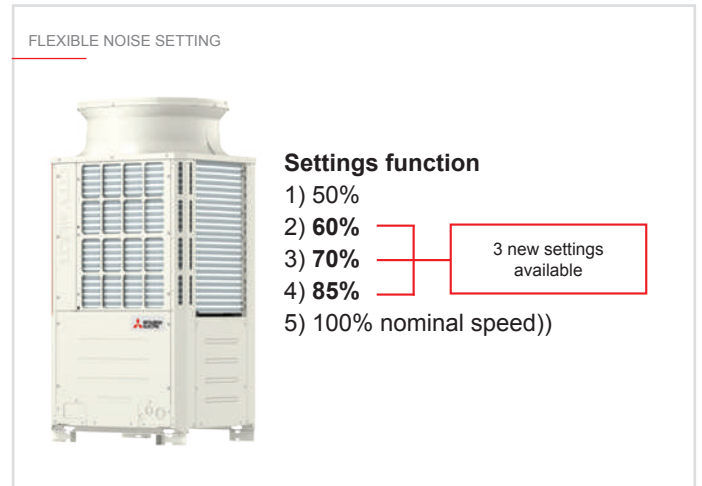



Energy efficiency control

Evaporating temperature control (during cooling)

In a traditional system, the evaporation temperature is kept constant regardless of the system load conditions. In low load conditions (when thermal loads to be dealt with are limited) increasing the evaporation temperature of the system decreases the compressor's workload and consequently limits the electrical absorption of the outdoor unit without affecting the environmental comfort level.

EVAPORATING TEMPERATURE CONTROL (DURING COOLING) NORMAL MODE

The evaporating temperature is kept constant regardless of the load. Even at low loads, the normal evaporating temperature does not change, which leads to energy losses during partial load operation.

SMART EVAPORATING TEMPERATURE CONTROL MODE

The evaporating temperature is increased and the compressor input is decreased according to the load, resulting in increased operating efficiency. There are two patterns to control the evaporating temperature as follows:

- 1) The evaporating temperature is controlled to be constant, regardless of the ΔT . The evaporating temperature is set to a value that is higher than the normal evaporating temperature.
- 2) The evaporating temperature is controlled by shifting it according to the ΔT . The user can select from 4 control patterns.

- * The availability of 1 and 2 varies depending on the model. Refer to the function table.
- * Changing the evaporating temperature reduces latent heat capacity. Select an appropriate pattern according to the installation conditions.

SUITABLE SITUATIONS

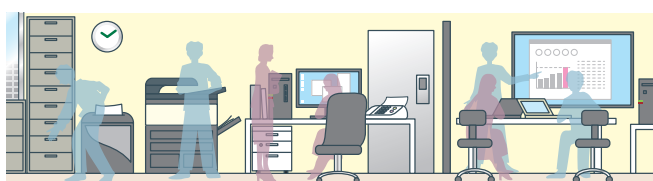

- Spaces with constant high temperatures from heat sources such as OA equipment
- When the load is low during periods when air conditioners are used for cooling (such as during the morning).

The new outdoor units are equipped with an evaporation temperature selection function, which automatically takes the system load conditions into account.

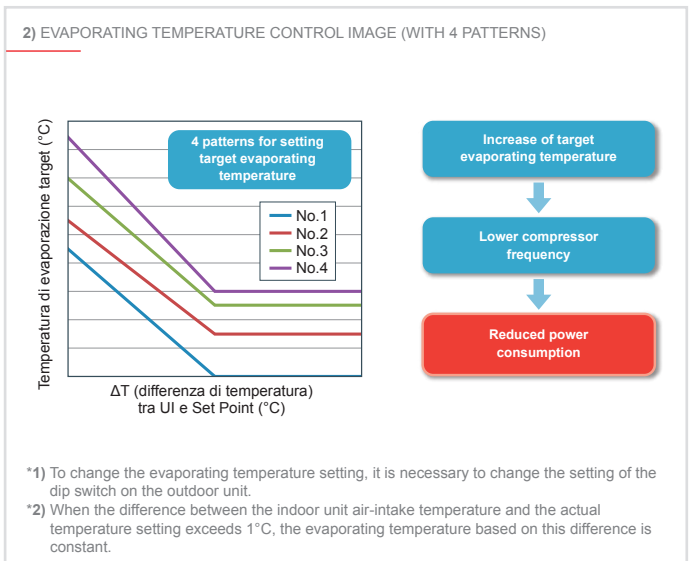
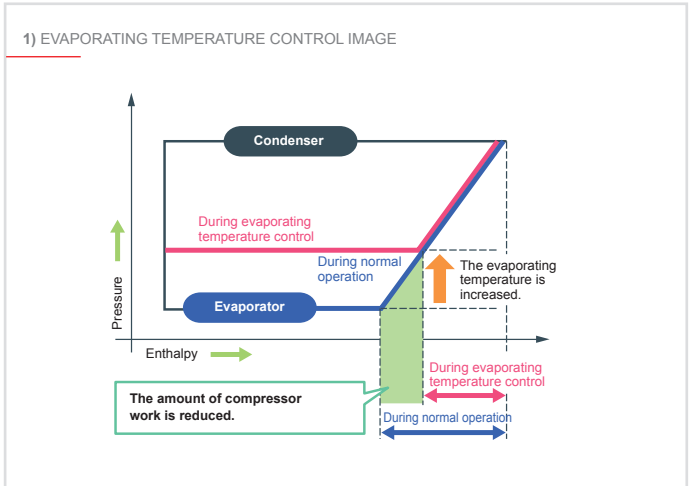

Compressor: new induction heating technology

The Y Line and R2 Line outdoor units employ a pre-heating system for the scroll compressor based on induction technology. This solution is used to warm the compressor housing to minimise energy absorption in stand-by state. Yet another solution contributing to reducing energy consumption.



NEW

High sensible heat

High sensible heat operation

The evaporating temperature is controlled according to room temperature and humidity, and refrigerant pressure.

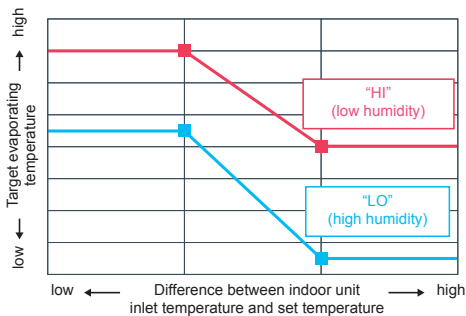

With high sensible heat operation mode activated, air conditioners consume less energy, thereby realizing cost savings. If a locally-procured humidity sensor is installed, the evaporating temperature of the outdoor unit can be controlled optimally as shown below according to the difference between the indoor unit inlet temperature and set temperature. A wide range of temperature settings are available, from a low evaporating temperature close to the temperature for normal operation to a high evaporating temperature to realize energy savings.

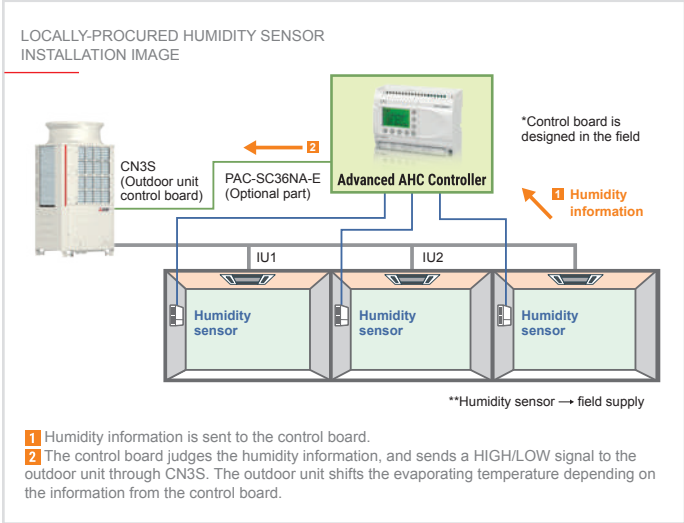

TEMPERATURE AND HUMIDITY CONDITIONS

	Room state	Condition of outdoor unit	Zone	Evaporating temperature control
<p>Comfortable temperature and humidity</p> <p>High sensible heat operation</p>	<p>Comfortable</p>	<p>Comfortable and energy-saving operation even at low compressor rotating speed</p>	<p>Umiedita</p> <p>Temperature</p>	<p>Temperature of refrigerant in indoor unit kept high</p> <p>Hi</p> <p>Lo</p>
<p>High humidity</p>	<p>A little humid</p>	<p>Compressor rotating at medium speed to reduce humidity</p>	<p>Umiedita</p> <p>Temperature</p>	<p>Temperature of refrigerant in indoor unit slightly reduced</p> <p>Hi</p> <p>Lo</p>
<p>High temperature and humidity</p>	<p>Uncomfortable</p>	<p>Compressor rotating at high speed to reduce temperature and humidity</p>	<p>Umiedita</p> <p>Temperature</p>	<p>Temperature of refrigerant in indoor unit greatly reduced</p> <p>Hi</p> <p>Lo</p>



Dual Set Point

Normally, the desired room temperature is set to the same value for cooling and heating. However, the dual set point function makes it possible to set different temperatures for cooling and heating. When operation switches from cooling to heating or vice versa, the preset temperature changes accordingly.

Setting dual set points for the Auto mode on R2 and WR2 helps improve energy efficiency, compared to setting a single set point.

When the operation mode is set to the Auto (dual set point) mode, two preset temperatures (one each for cooling and heating) can be set. Depending on the room temperature, the indoor unit will automatically operate in either the Cool or Heat mode and keep the room temperature within the preset range. The outdoor unit does not operate in the dead band defined by two temperature points where the thermostat is off. This cuts down on unnecessary operation of the air conditioning system.

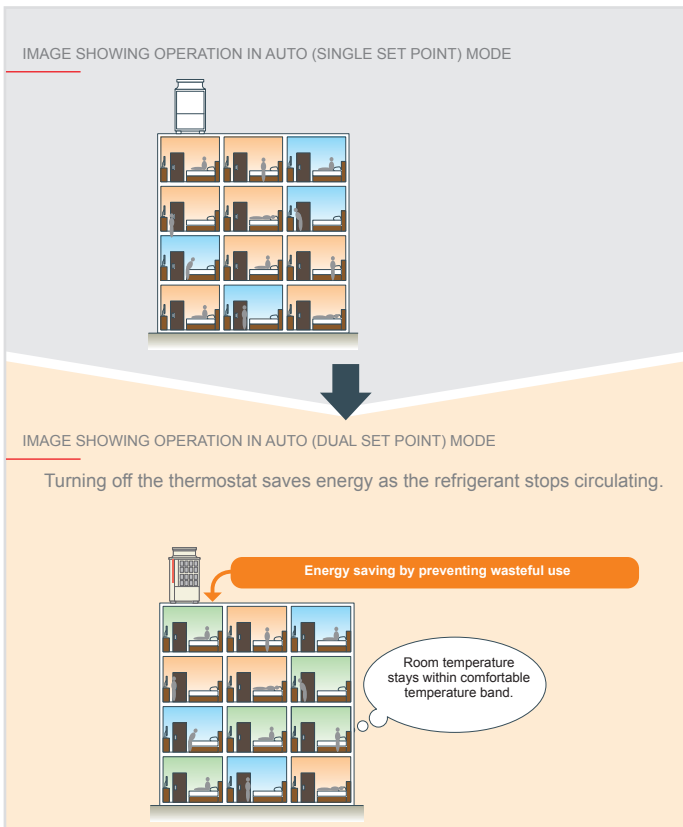
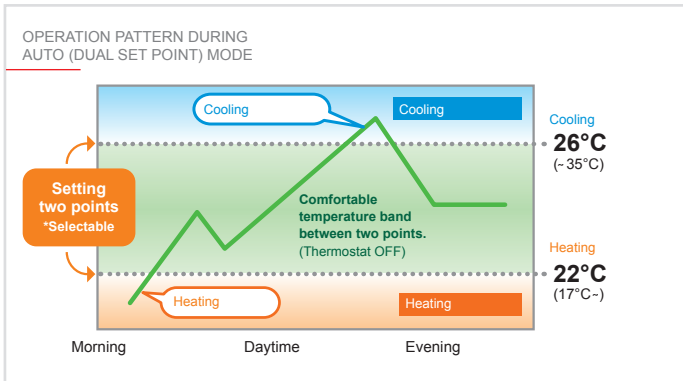

Heating operation Cooling operation Thermo OFF



Smooth auto-shift startup mode

Smooth auto-shift startup mode, a new operation mode on the outdoor unit, can now be selected in addition to the conventional COP Priority and Capacity Priority modes. In order to heat the room faster, Capacity Priority mode runs for 30 minutes when heating operation starts. The unit then switches to COP Priority mode to increase energy-saving efficiency. This enables both improved comfort and energy savings.

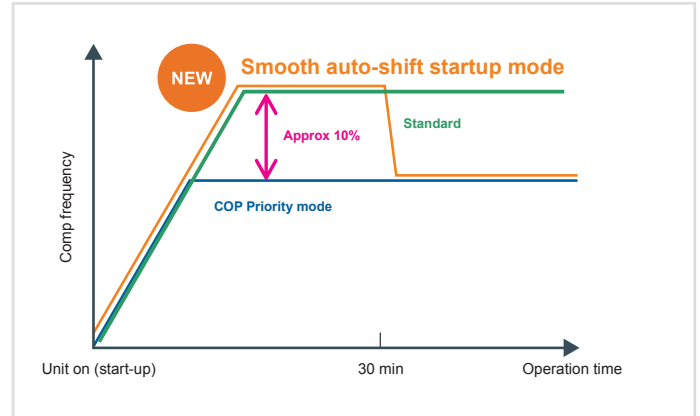

Installation and maintenance

R410A R407C Multi-refrigerant

The indoor units of VRF CITY MULTI systems are the first and only products on the market with multi-refrigerant capability. These units can operate with R22, R407C and R410A systems with no loss in performance, irrespective of the different pipe sizes. This allows unparalleled freedom for installation, as well as offering total reverse compatibility in the event of replacing indoor units with an R22 or R407C VRF CITY MULTI system.

NEW 80Pa Selectable external static pressure of the outdoor unit

The static pressure specification of the outdoor unit can be selected (0, 30, 60, or 80 Pa). This facilitates installation of the unit on each floor of a high-rise building or on balconies. The static pressure that can be set varies depending on the model.

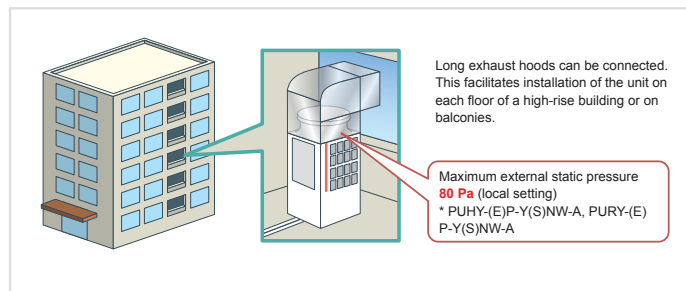

Intelligent Terminal Boards

Intelligent indoor unit terminal boards are a unique feature of Mitsubishi Electric VRF systems. These intelligent terminal boards make it possible to use the air conditioning system and the M-NET communication network, via the indoor units, as a vehicle for collecting, transferring and monitoring field signals from generic appliances such as lighting, power, access management, intelligent alarm systems etc. Using the intelligent terminal boards of the indoor units together with the existing infrastructure drastically reduces the number of cables needed to collect these field signals and the amount of labour required to route the cables to the centralized units. Typically, each indoor unit supports the following signals and functions:

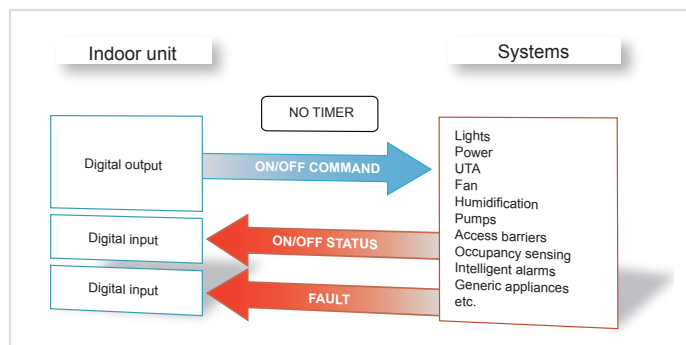

NEW Usable in an application with a large vertical separation of up to 90 meters

A height difference of up to 90 m from the outdoor unit to the indoor unit can be supported with no extra-cost options. This increases design flexibility and facilitates installation of these units even in high-rise buildings.

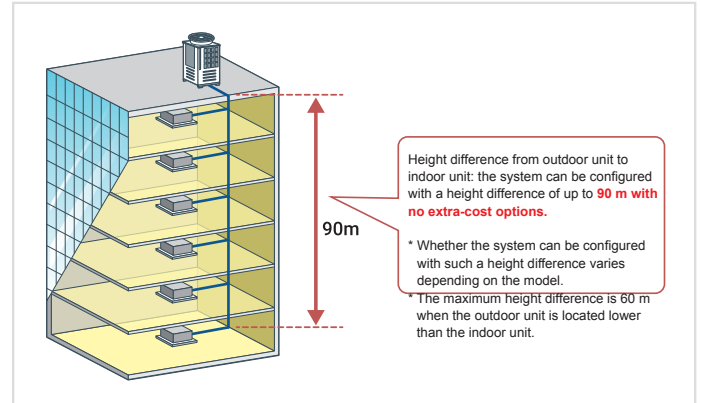

Self-diagnosis of VRF CITY MULTI system

For even simpler maintenance, CITY MULTI systems have a self-diagnostic function which is capable of communicating malfunctions on different levels using fault codes. With the special Maintenance Tool software developed by Mitsubishi Electric, the user can connect to any point in the transmission line to acquire all technical operating information interactively.

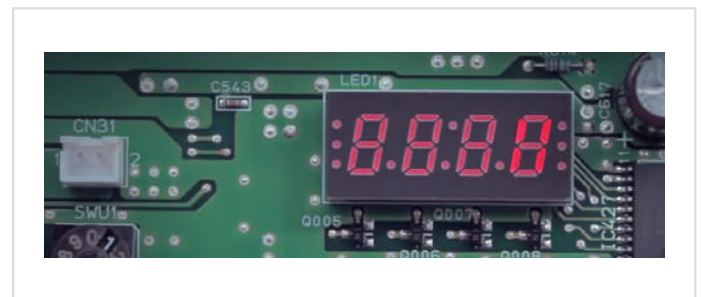

NEW USB Downloading operating data via USB

Operation data was retrieved from conventional models using the maintenance tool. On the new model, the data can be retrieved quickly via USB*1. It is unnecessary to carry the personal computer in which the maintenance tool has been installed, reducing field operation time and improving convenience. Software can be rewritten via USB, while data for up to 4 days and the 5 minutes after an error has occurred can be stored in the the USB memory device*2.

*1 In the case of OC-IC maximum configuration
*2 USB memory devices conforming to USB2.0 can be used.





HVRF System Line

Heat pump systems

HVRF Y Systems

HEAT PUMP

178

Hydronic unit

180

HVRF Y System architecture

182

System Components

AIR-COOLED

PUHY-M YNW-A1 (-BS)

184

HYDRONIC UNIT

CMH-WM V-A

186

Design guide

187



HYDRONICVRF



HVRF Hydronic Systems

Heat Pump



Complete system

HVRF Y systems are based on a modular concept and a complete solution of Mitsubishi Electric branded products.

All system components: Outdoor Units, Hydronic Units, Indoor Units, Control Systems are native to Mitsubishi Electric and communicate with each other through the "M-Net" communication system.

The regulation of HVRF systems is also Mitsubishi Electric unlike traditional Hydronic systems.

Less refrigerant required

The hydronic unit creates a separation between the area delimited by the refrigerant and the area delimited by the water fluid, limiting the amount of refrigerant that was measured to be around 61%.

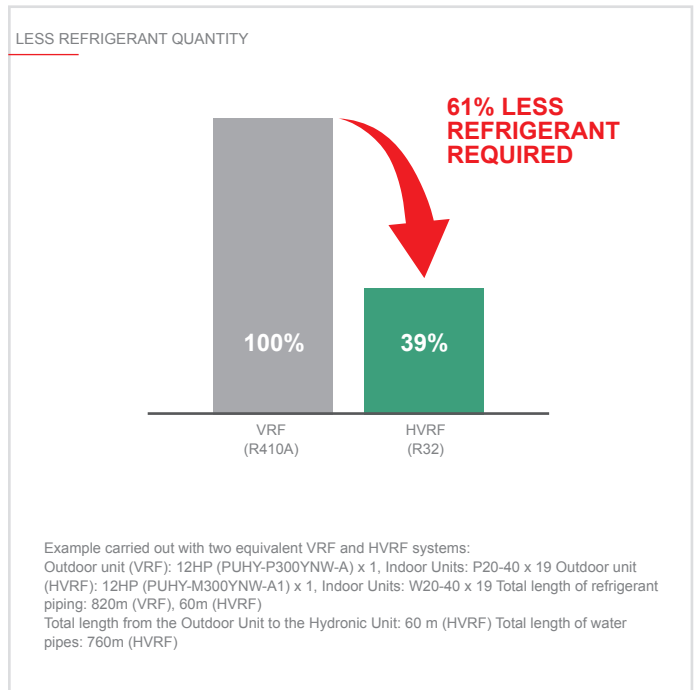
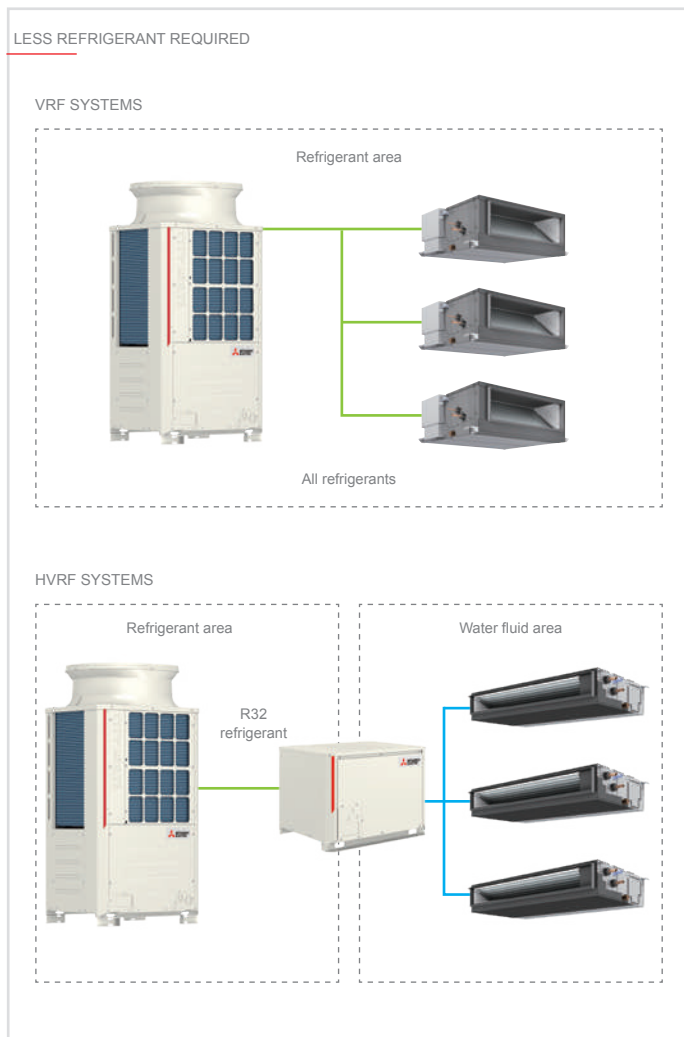

R32 refrigerant with low environmental impact

Starting from the HVRF Y range, Mitsubishi Electric chooses R32 gas with low GWP ("global warming potential") 675, approximately 67% less than the 2088 value of R410A gas.

The advantage is in terms of a net reduction in the amount of CO2 equivalent in the environment. Adding the benefits of 61% less refrigerant and 67% less GWP, the reduction amounts to 87% for the CO2 released in the environment.

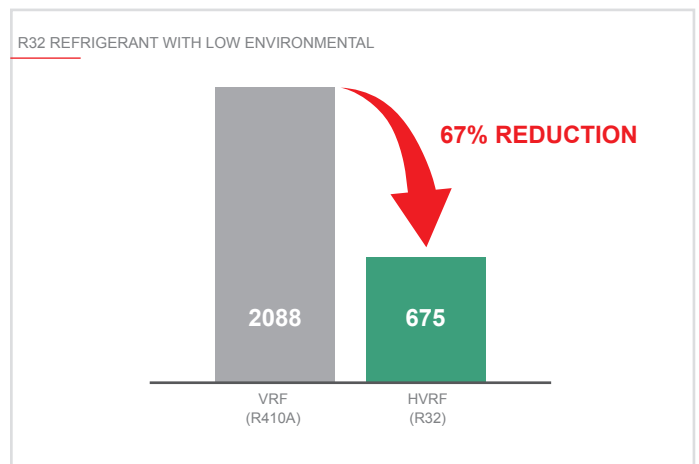



Hydronic unit



HYDRONICVRF

R32

Hydronic unit

The hydronic unit is the fundamental element of the HVRF Y heat pump system, it connects the CITY MULTI outdoor unit to the indoor units via the hydronic system.

The integrated plate exchanger exchanges heat between refrigerant and water.

The integrated pump regulated by an inverter allows the water to reach the indoor units according to the actual cooling and heating needs, allowing efficient operation.

The R32 refrigerant pipes are limited in the section between the Outdoor Unit and the Hydronic Unit, helping to reduce the amount of refrigerant compared to VFR CITY MULTI systems.

The HVRF Y system's hydronic unit can be installed in the building, making the use of antifreeze unnecessary. This reduces energy consumption compared to traditional chillers.

Optimal control

The Hydronic unit automatically calculates the water flow rate required for all indoor units by adapting the flow according to the required load. The pump is controlled with the inverter to determine the amount of water according to the internal load.

The optimal temperature of the supply water is automatically calculated and the corresponding command is communicated to the outdoor unit to define the evaporation and condensation target for the refrigerant gas production.

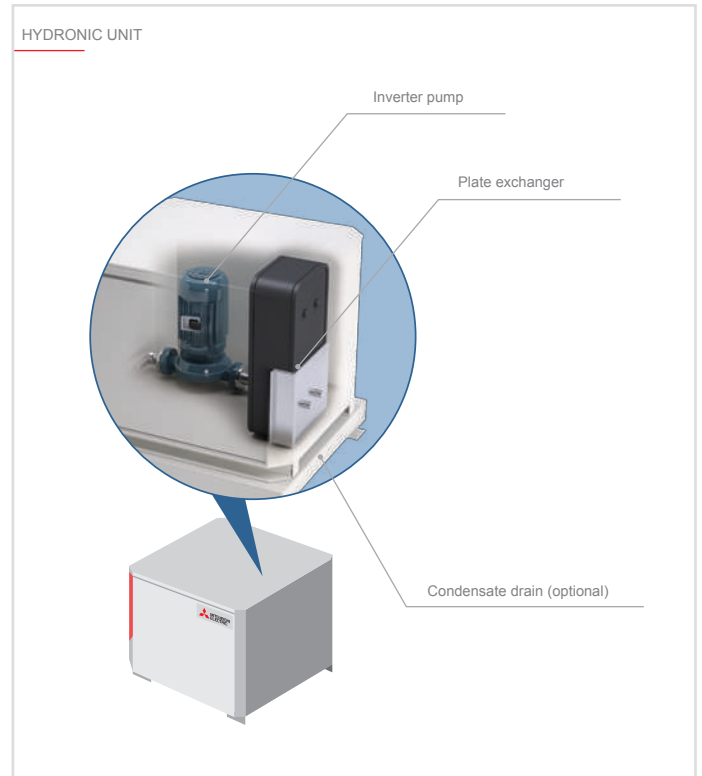



HVRF Y System architecture

Outdoor unit

Development of the compressor for the adoption of R32 refrigerant

R32 gas has a higher discharge temperature than R410A gas.

To better manage the increase in the discharge temperature, Mitsubishi Electric has redesigned the compressor by equipping it with a liquid injection mechanism in the suction chamber.

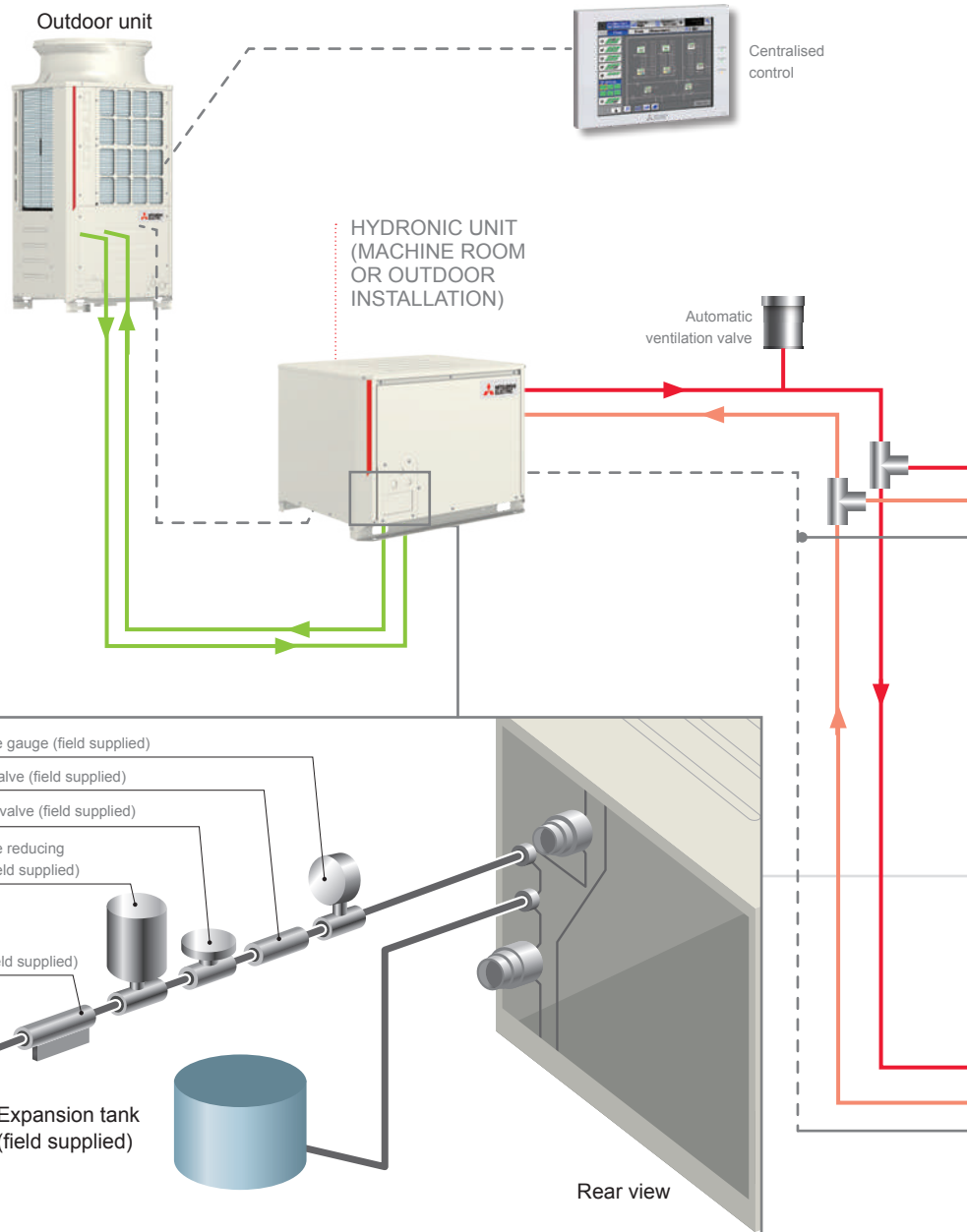
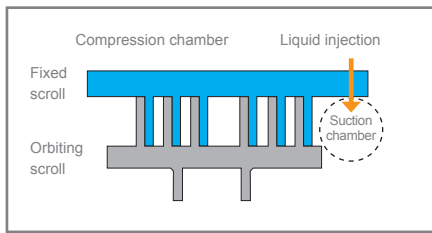

*Depending on the installation conditions, it may be necessary to use safety devices.

- Refrigerant
- Hot water supply
- Hot water return
- - - M-NET



Control systems

System control through M-NET

Mitsubishi Electric outdoor unit, indoor units, hydronic unit and individual and centralised control systems communicate through the M-Net communication system for optimal control of the entire system.

Indoor unit

Optimal control with the flow control valve

HVRF Y system indoor units are fitted with a flow control valve. Based on the internal load of each room, opening the valve automatically allows the correct supply of water to the indoor units serving each room.

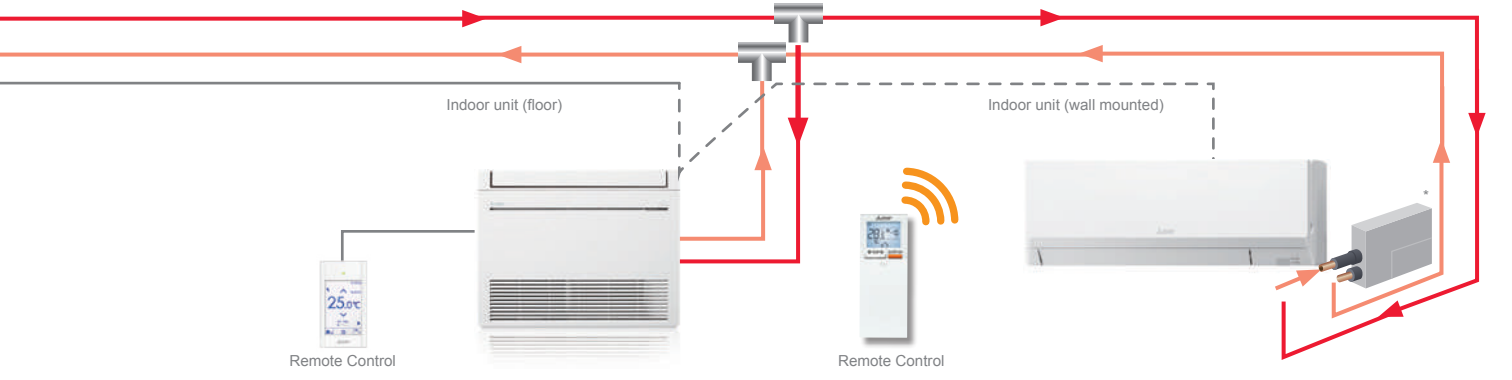
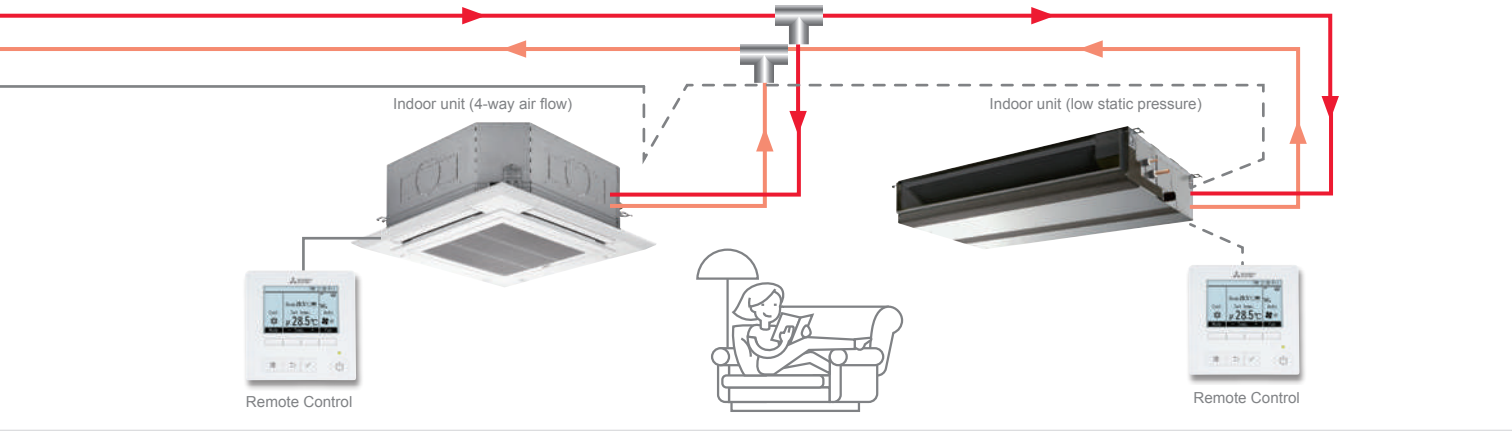
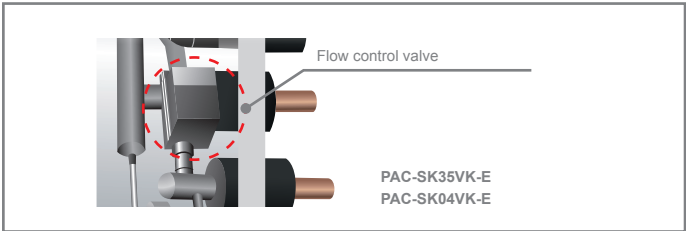

Specifications

Y Line OUTDOOR UNITS - HEAT PUMPS



R32



Technical specifications

MODEL			PUHY-M200YNW-A1(-BS)	PUHY-M250YNW-A1(-BS)	PUHY-M300YNW-A1(-BS)	PUHY-M350YNW-A1(-BS)
HP			8	10	12	14
Power Supply	Tens./Freq./Phases	V/Hz/n°	3-phase 4-wire 380-400-415 V 50/60 Hz			
Cooling	Nominal capacity*1	kW	22,4	28,0	33,5	40
	Power input	kW	5,53	8,38	9,85	12,15
	EER*	kW	4,05	3,34	3,40	3,29
	Temperature operating fields	Indoor BU	°C	15,0~24,0	15,0~24,0	15,0~24,0
Outdoor BS		°C	-5,0~52,0	-5,0~52,0	-5,0~52,0	-5,0~52,0
Heating	Nominal capacity*2	kW	25,0	31,5	37,5	45
	Power input	kW	5,70	8,18	9,66	12,16
	COP*	kW	4,38	3,85	3,88	3,70
	Temperature operating fields	Indoor BU	°C	15,0~27,0	15,0~27,0	15,0~27,0
Outdoor BS		°C	-20,0~15,5	-20,0~15,5	-20,0~15,5	-20,0~15,5
Sound pressure*3		dB(A)	58,0 / 59,0 75,0 / 78,0	60,0 / 61,0 78,0 / 80,0	61,0 / 64,5 80,0 / 83,5	62,0 / 64,0 80,5 / 83,0
	Connectable int. units.		Model/Quantity	W10~125, WL10~50/1~26	W10~125, WL10~50/1~32	W10~125, WL10~50/2~39
Ø refrigerant pipe	Liquid/Gas	mm	9,52/22,2	9,52/22,2	9,52/22,2	12,7/28,58
External dimensions **	(HxLxD)	mm	1858 x 920 x 740	1858 x 920 x 740	1858 x 920 x 740	1858 x 1240 x 740
Net weight		kg	222	222	223	270
Refr. charge R32/CO ₂ Eq		kg/Tons	6,5/4,39	6,5/4,39	6,5/4,39	9,8/6,62

*1 Rated cooling conditions: Indoor 27°C BS / 19°C BU. Outdoor 35°C BS. Pipe length 7.5 m, level difference 0 m. (subject to JIS B8615-2)

*2 Rated heating conditions: Indoor 20°C BS. External 7°C BS / 6°C BU. Pipe length 7.5 m, level difference 0 m. (subject to JIS B8615-2)

*3 Values measured in anechoic chamber. Cooling / Heating

*4 GWP of HFC R32 equal to 675 according to regulation 517 / 2014

*The COP and EER coefficients are system performances and as such do not refer just to the outdoor unit but include both the water production coefficients (Outdoor Unit + Hydronic Unit) and the water distribution coefficients (Hydronic Unit + Indoor units).

**Without removable support feet, A = 1798 mm



Technical specifications

MODEL			PUHY-M400YNW-A1(-BS)	PUHY-M450YNW-A1(-BS)	PUHY-M500YNW-A1(-BS)
HP			16	18	20
Power Supply	Tens./Freq./Phases	V/Hz/n°	3-phase 4-wire 380-400-415 V 50/60 Hz		
Cooling	Nominal capacity*1	kW	45	50	56
	Power input	kW	14,65	14,70	17,72
	EER*	kW	3,07	3,40	3,16
	Temperature operating fields	Indoor BU	°C	15,0~24,0	15,0~24,0
Outdoor BS		°C	-5,0~52,0	-5,0~52,0	-5,0~52,0
Heating	Nominal capacity*2	kW	50	56	63
	Power input	kW	13,69	16	17,07
	COP*	kW	3,65	3,50	3,69
	Temperature operating fields	Indoor BU	°C	15,0~27,0	15,0~27,0
Outdoor BS		°C	-20,0~15,5	-20,0~15,5	-20,0~15,5
Sound pressure*3		dB(A)	65.0 / 67.0 82.5 / 86.0	65.5 / 69.5 83.5 / 88.5	63.5 / 66.5 82 / 85.5
Connectable int. units.	Model/Quantity		W10~125,WL10~50/2~50	W10~125, WL10~50/2~50	W10~125, WL10~50/2~50
Ø refrigerant pipe	Liquid/Gas	mm	12,7/28,58	15,88/28,58	15,88/28,58
External dimensions **	(HxLxD)	mm	1858 x 1240 x 740	1858 x 1240 x 740	1858 x 1750 x 740
Net weight		kg	273	290	329
Refr. charge R32/CO ₂ Eq		kg/Tons	9,8/6,62	10,8/7,29	10,8/7,29

*1 Rated cooling conditions: Indoor 27°C BS / 19°C BU. Outdoor 35°C BS. Pipe length 7.5 m, level difference 0 m. (subject to JIS B8615-2)

*2 Rated heating conditions: Indoor 20°C BS. External 7°C BS / 6°C BU. Pipe length 7.5 m, level difference 0 m. (subject to JIS B8615-2)

*3 Values measured in anechoic chamber. Cooling / Heating

*4 GWP of HFC R32 equal to 675 according to regulation 517 / 2014

*The COP and EER coefficients are system performances and as such do not refer just to the outdoor unit but include both the water production coefficients (Outdoor Unit + Hydronic Unit) and the water distribution coefficients (Hydronic Unit + Indoor units).

**Without removable support feet, A = 1798 mm

Hydronic unit



R32

Technical specifications

MODEL			CMH-WM250V-A		CMH-WM350V-A		CMH-WM500V-A	
Power source	Phases/ Tens.		1-phase 220-230-240 V					
	Frequency		50 Hz					
Power input	Cooling	kW	0.74		0.90		1.06	
	Heating	kW	0.74		0.90		1.06	
Sound pressure level (measured in anechoic room)		dB <A>	60		60		60	
Applicable temperature range of installation site		°C (D.B.)	-5~52		-5~52		-5~52	
Connectable outdoor/heat source unit capacity			M200~250		M300~350		M400~500	
External dimension	HxWxD	mm	660 x 920 x 740		660 x 920 x 740		660 x 920 x 740	
Refrigerant piping diameter	To outdoor/heat source unit		Connectable outdoor/heat source unit capacity		Connectable outdoor/heat source unit capacity		Connectable outdoor/heat source unit capacity	
			M200	M250	M300	M350	M400	M450/500
	Liquid pipe	mm O.D.	9.52	9.52	9.52	12.7	12.7	15.88
	Gas pipe	mm O.D.	22.2	22.2	22.2	28.58	28.58	28.58
Water piping diameter	To Indoor unit							
	Inlet Pipe	mm I.D.	40 (1-1/2) housing joint		40 (1-1/2) housing joint		50 (2) housing joint	
	Outlet Pipe	mm I.D.	40 (1-1/2) housing joint		40 (1-1/2) housing joint		50 (2) housing joint	
Net weight		kg	112		117		143	

*The equipment is for R32 refrigerant.

*Install this product in a location where noise (refrigerant noise) emitted by the unit will not disturb the neighbors.

(For use in quiet environments with low background noise, position the Hydro unit at least 5 m away from any indoor units.)

*Please install the Hydro unit in a place where noise will not be an issue.

*Please attach an expansion vessel (field supply).

*Use copper, plastic, steel, or stainless steel pipes for the water circuit.

Furthermore, when using copper pipe-work use a non-oxidative brazing method.

Oxidation of the pipe-work will reduce the pump life.

*When blazing the pipes, be sure to blaze, after covering a wet cloth to the insulation pipes of the units in order to prevent it from burning and shrinking by heat.

*Please install an air purge valve where air will gather in the water circuit.

*Please install a pressure reducing valve and a strainer on the water supply to the Hydro unit.

*Please refer to the databook or the installation manual for the specified water quality.

*Please always make water circulate or pull out the circulation water completely when not using it.

(Please do not use it as a drinking water.)

*Please do not use ground water and well water.

*When installing the Hydro unit in an environment which may drop below 0 °C, please add antifreeze to the circulating water.(Refer to the data-book and the installation manual).

*R32 is flammable, and certain restrictions apply to the installation of units.

When installing new units, moving the existing units, or changing the layout of the room, ensure that installation restrictions are observed.

For detail, refer to the section in the Databook on installation restrictions.

*Drain or condensation water will be discharged from hydro units during test run.

If this will be a problem, install a separately sold drain pan.

*Do not install the unit where it could be salt-damaged.



Design guide

HVRF Hydronic Heat Pump Systems

Item	Circuit section	Maximum length (m)
Effective length between outdoor unit and hydronic unit		
(Refrigerant piping)	A	110
Effective length between Outdoor Unit and furthest indoor unit (L1)	$A+A'+C+D+E+g/A+B+c$	165
Effective length between Hydronic Unit and furthest indoor unit (L2)	$A'+C+D+E+g/A'+B+c$	60
Difference in height between outdoor unit and indoor unit		
(Outdoor unit above/below the indoor unit)	H/H'	90/60
Difference in height between outdoor unit and hydronic unit		
(Outdoor unit above/below the hydronic unit)	H1/H1'	50' / 40 ²
Difference in height between hydronic unit and indoor unit		
(Hydronic unit above/below the indoor unit)	H2/ H2'	50/40
Difference in height between indoor units	h1	30

*1 90 m is available depending on the model and installation conditions. For more detailed information, please contact your local distributor.
 *2 60 m is available depending on the model and installation conditions. For more detailed information, please contact your local distributor.

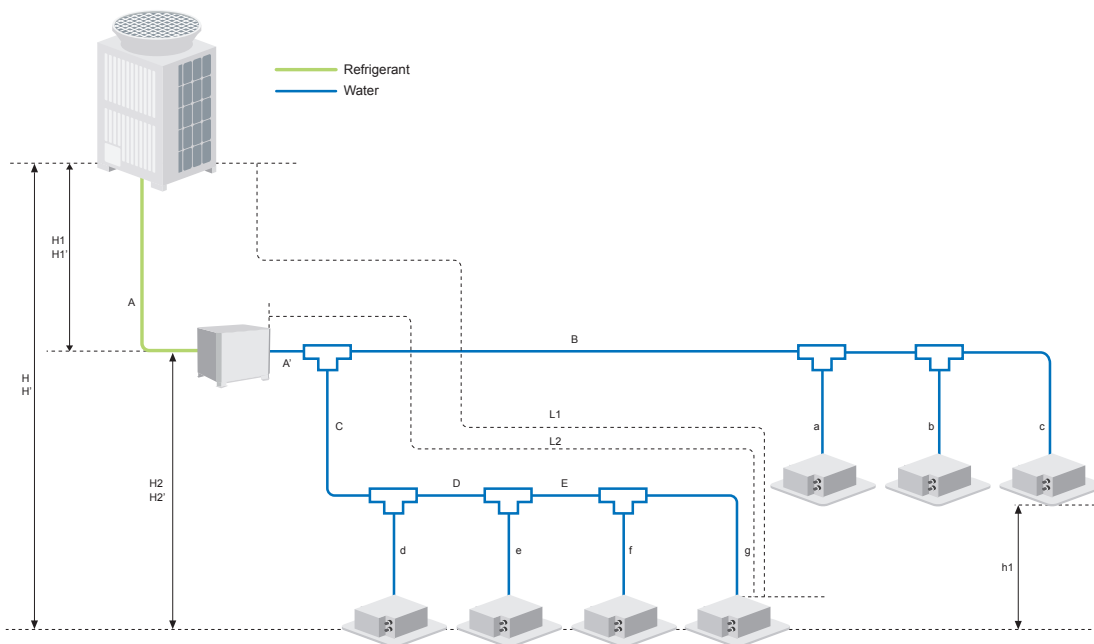

HVRF Systems Line

Heat recovery systems

HVRF R2/WR2 systems

HEAT RECOVERY 186

Hydronic Branch Controller (HBC)

188

HVRF R2/WR2 System architecture

190

System Components

AIR-COOLED

PURY-P YNW-A2 (-BS) 192

WATER-COOLED

PQRY-P YLM-A1 194

MAIN HBC CONTROLLER

CMB-WM 196

Design guide

198



HYDRONICVRF



HVRF R2/WR2 systems

Heat Recovery



Hydronic CITY MULTI

Hydronic CITY MULTI is the first and only system in the world derived from the R2 system to guarantee a high degree of air comfort with the advantages of direct expansion with variable refrigerant flow.

Why Hydronic VRF

Hydronic CITY MULTI is a heat recovery system (simultaneous heating and cooling) which becomes part of the CITY MULTI family and which adopts water for the first time to distribute the heating and cooling power in the room.

Hydronic BC Distributor

Simultaneous cooling/heating with heat recovery. The new Hydronic CITY MULTI is the first and only two-pipe system in the world for simultaneous cooling and heating with heat recovery that combines the advantages of the direct expansion system with those of the traditional hydronic system. The technology is based on Mitsubishi Electric's CITY MULTI R2 heat recovery system and consists of an R2 (or WR2) outdoor unit of the CITY MULTI series, the innovative Hydronic BC (HBC) distributor which allows the use of refrigerant gas and water as heat carrier fluids, as well as indoor units specially equipped with a water coil.

Lower concentration of R410 GAS

The use of hydronic distribution allows the limits linked to the stringent legislation (UNI EN 378) on the concentration of refrigerant gases to be overcome: this is possible thanks to the fact that the only portion of the system that contains refrigerant gas is the one that connects the outdoor unit to the Hydronic BC Controller distributor. In this way it is possible to obtain up to 45% reduction of the refrigerant charge compared to a traditional VRF system.

2-Pipe systems

Compared to a traditional 4-pipe hydronic system, the design and installation of the 2-pipe system is very flexible and simplified. For example, the Hydronic CITY MULTI system does not need additional pumps, tanks or switching valves. The significantly smaller number of connection points in the two-pipe system limits its potential for leakage, makes it safer and reduces the need for maintenance.

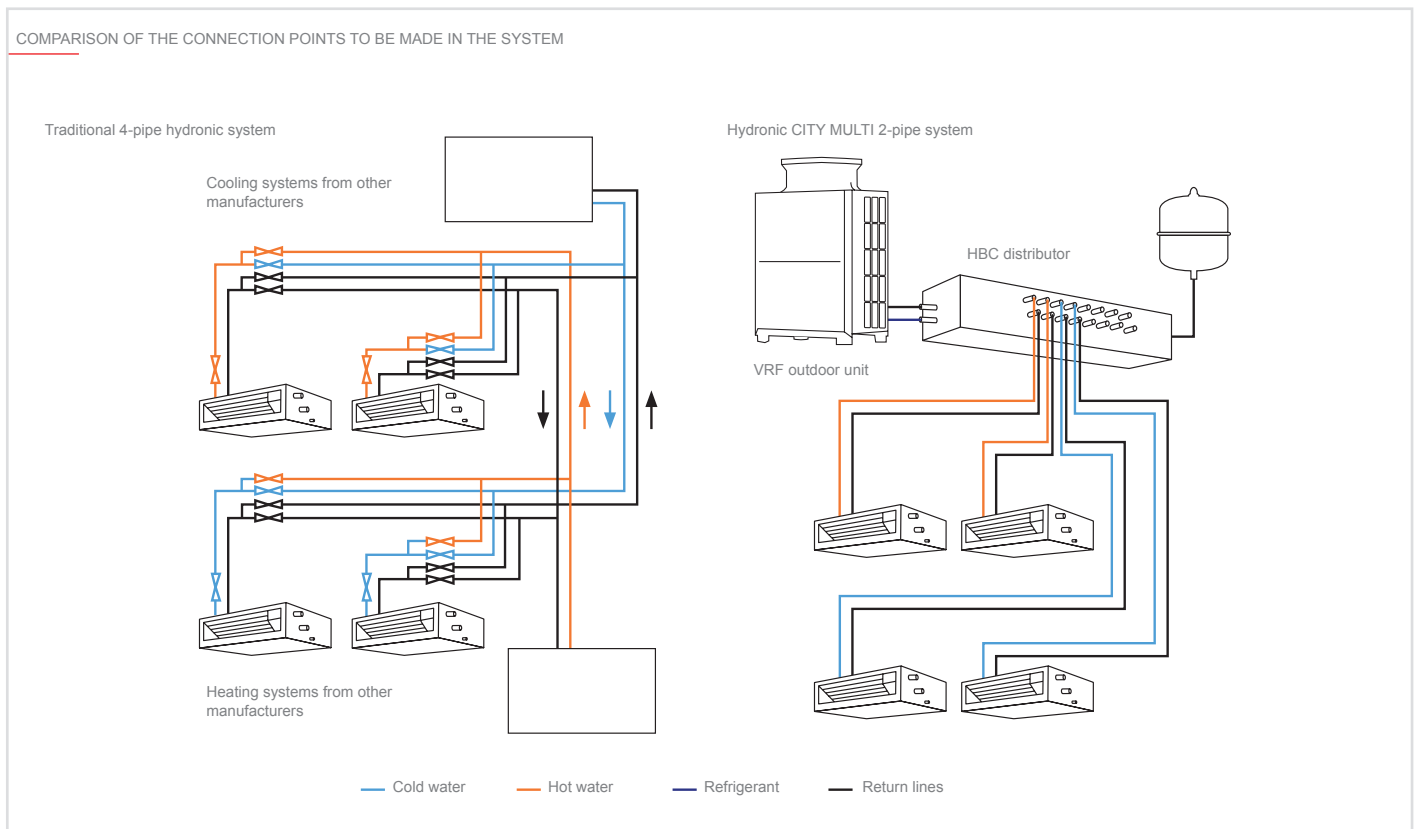



Hydronic Branch Controller (HBC)

The heart of Hybrid VRF

Plate heat exchangers

This is the component where the refrigerant gas is able to yield/absorb heat from the water line.

Two plate heat exchangers are installed, located at the ends of the HBC. Both can produce hot water during heating mode and cold water during cooling mode.

During “simultaneous mode” one of the heat exchangers produces hot water while the other one cold water.

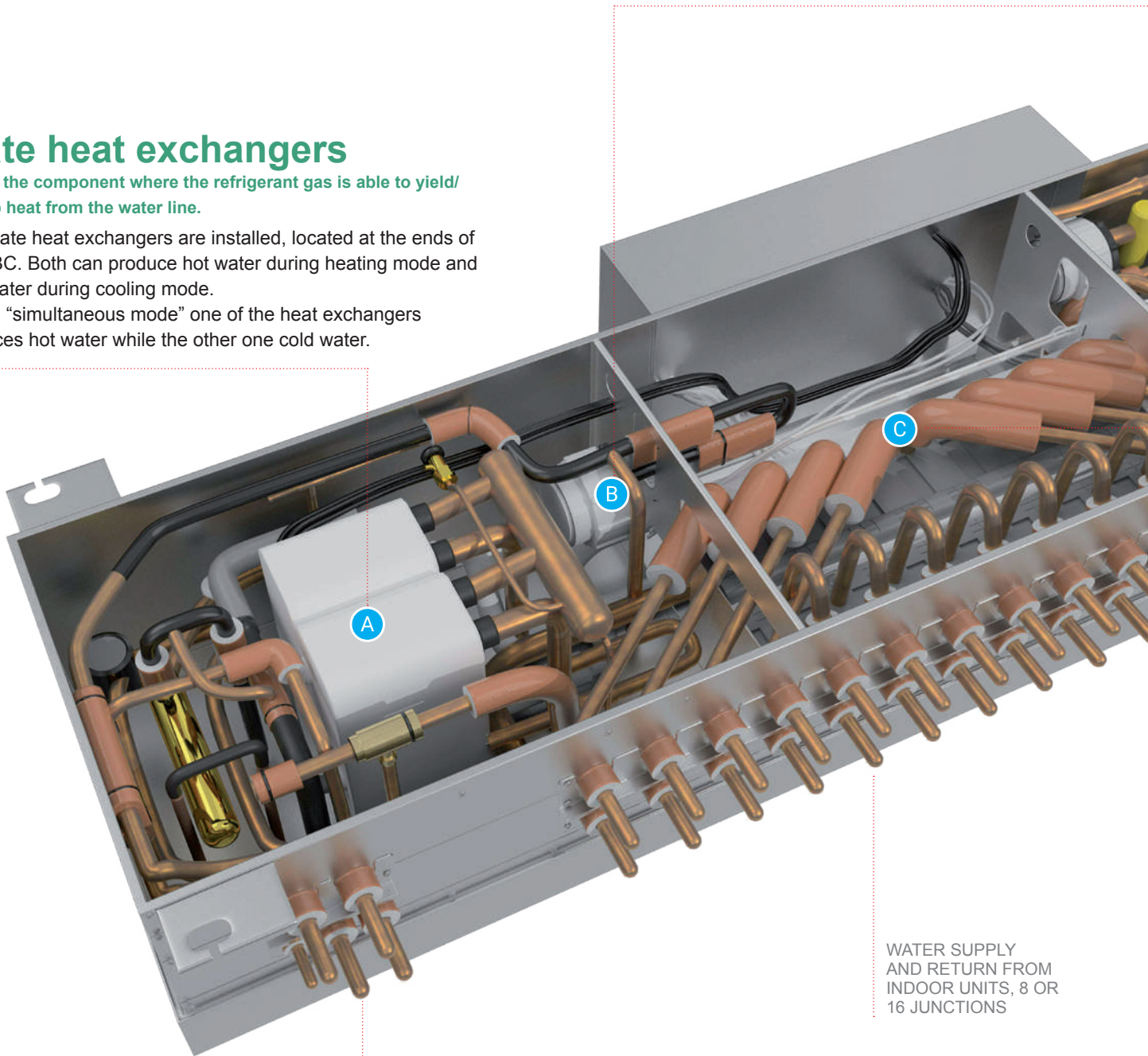

REFRIGERANT PIPES TO OUTDOOR UNIT, EXPANTION VESSEL (FIELD SUPPLIED) AND WATER FEEDING LINE (FIELD SUPPLIED)

WATER SUPPLY AND RETURN FROM INDOOR UNITS, 8 OR 16 JUNCTIONS

Pumps

Both plate heat exchangers are equipped with pumps.

The pumps allow circulation of water between HBC and the indoor units. The flow rate is controlled by a valves block.

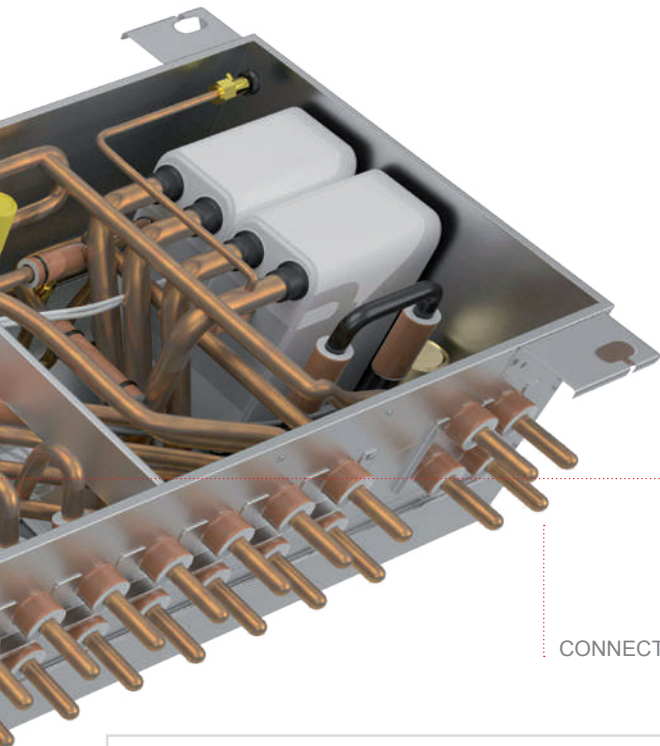

Valves Block

A set of valves is connected to supply and return pipes of each indoor unit.

This valves block has two tasks: firstly it selects the hot or cold water header and then it regulates the flow fed to the indoor units based on the thermal power required.

CONNECTION TO SUB HBC

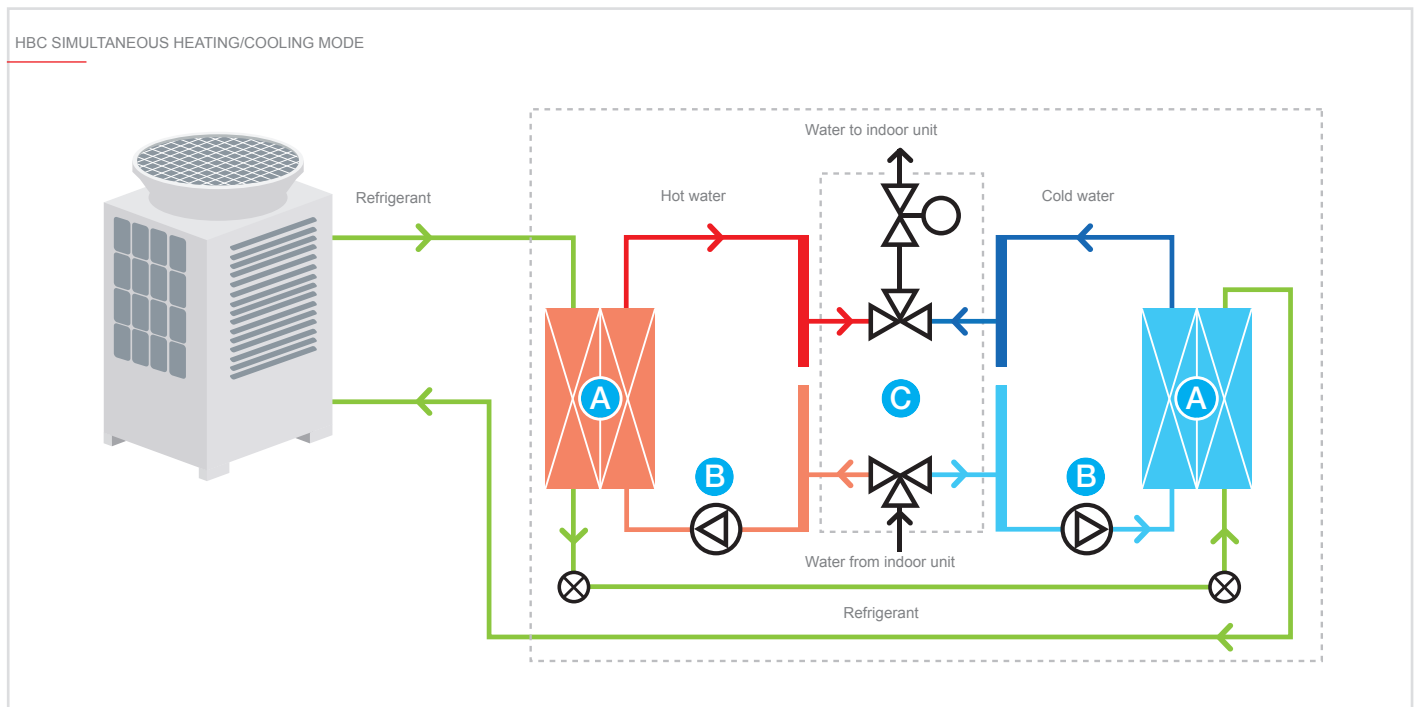



HVRF R2/WR2 System architecture

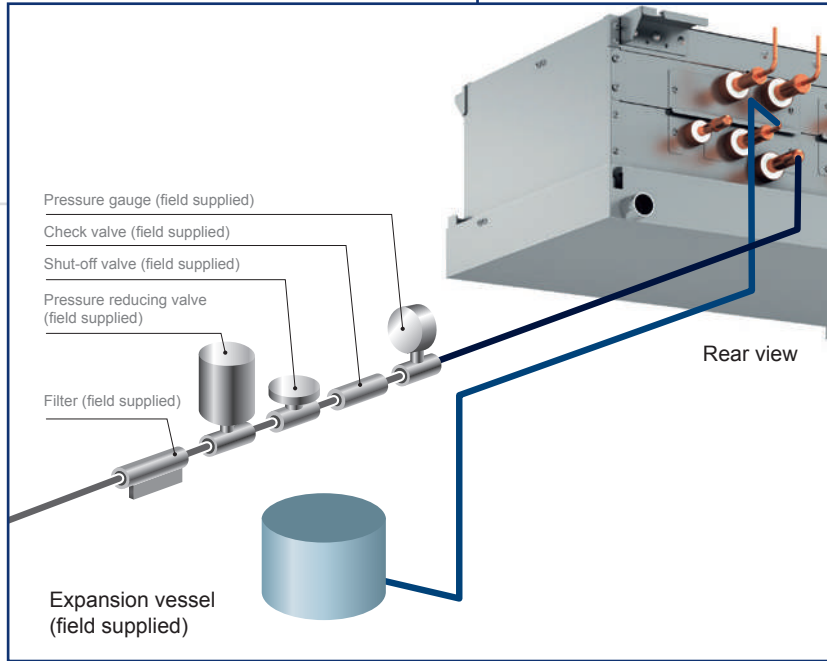
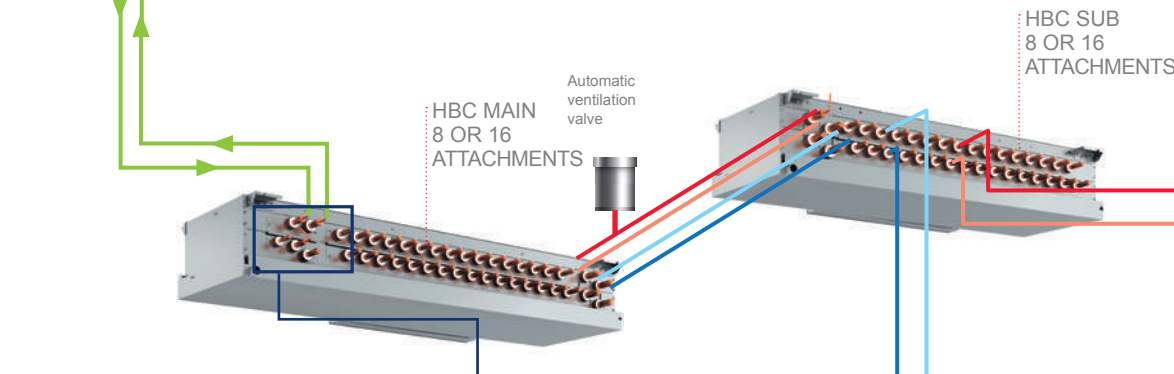

- Refrigerant
- Hot water supply
- Hot water return
- Cold water supply
- Cold water return



PURY/PQRY Outdoor unit	FIRST HBC MAIN	FIRST HBC SUB	SECOND HBC MAIN	SECOND HBC SUB
P200	•	•*	X	X
P250	•	•*	X	X
P300	•	•*	•*	•*
P350	•	•*	•*	•*
P400	•	•*	•	•*
P450	•	•*	•	•*
P500	•	•*	•	•*

*Optional

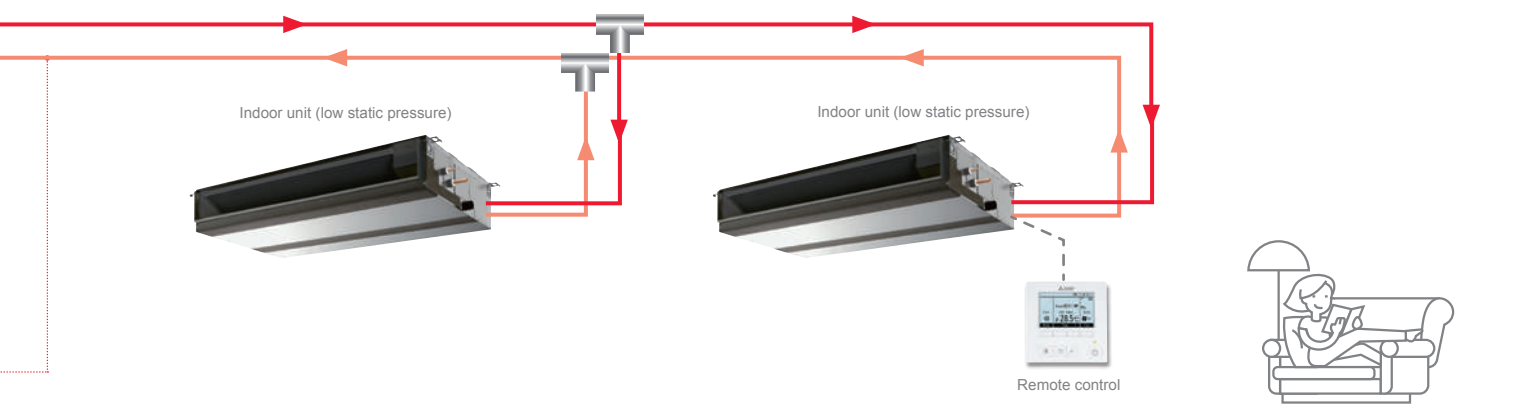

The water pipes (20 mm) provide heating and cooling simultaneously

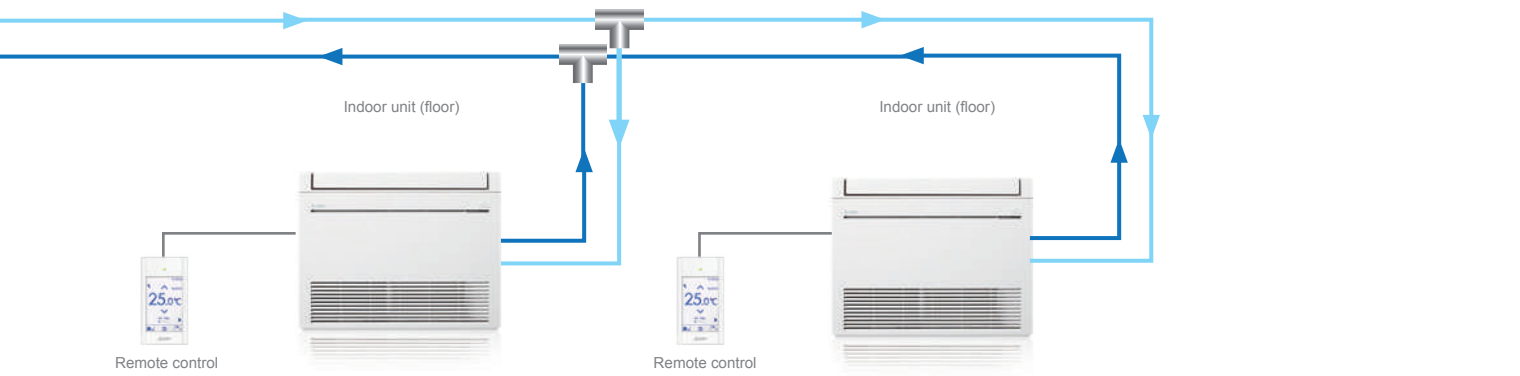

Specifications

R2 Line HEAT RECOVERY OUTDOOR UNIT



Technical specifications

MODEL			PURY-P200YNW-A2 (-BS)	PURY-P250YNW-A2(-BS)	PURY-P300YNW-A2 (-BS)	
HP			8	10	12	
Power Supply	Tens./Freq./Phases	V/Hz/n°	3-phase 4-wire 380-400-415 V 50/60 Hz			
Cooling	Nominal capacity*1	kW	22,4	28,0	33,5	
	Power input	kW	6,54	9,92	13,13	
	EER*	kW	3,42	2,82	2,55	
	Temperature operating fields	Indoor WB	°C	15.0~24.0°C (59~75°F)	15.0~24.0°C (59~75°F)	15.0~24.0°C (59~75°F)
		Outdoor DB	°C	-5.0~52.0°C (23~126°F)	-5.0~52.0°C (23~126°F)	-5.0~52.0°C (23~126°F)
Heating	Nominal capacity*2	kW	25,0	31,5	33,5	
	Power input	kW	6,49	10,06	11,35	
	COP*	kW	3,85	3,13	2,95	
	Temperature operating fields	Indoor DB	°C	15.0~27.0°C (59~81°F)	15.0~27.0°C (59~81°F)	15.0~27.0°C (59~81°F)
		Outdoor WB	°C	-20.0~15.5°C (-4~60°F)	-20.0~15.5°C (-4~60°F)	-20.0~15.5°C (-4~60°F)
Sound pressure*3		dB(A)	59,0/59,0 (76/76)	60,5/64,0 (78/83)	61,0/67,0 (80/86)	
Connectable int. units.	Model/Quantity		W/WP/WL 10~125/1~30	W/WP/WL 10~125/1~37	W/WP/WL 10~125/2~45	
Ø refrigerant pipe	Liquid/Gas	mm	15,88/19,05	19,05/22,2	19,05/22,2	
External dimensions	(HxLxD)	mm	1,858 (1,798) x 920 x 740	1,858 (1,798) x 920 x 740	1,858 (1,798) x 920 x 740	
Net weight		kg	214	223	225	
Refr. charge R410A/CO ₂ Eq		kg/Tons	5,2/10,86	5,2/10,86	5,2/10,86	

*1 Rated cooling conditions: Indoor 27°C BS / 19°C BU. Outdoor 35°C BS. Pipe length 7.5 m, level difference 0 m. (subject to JIS B8615-2)

*2 Rated heating conditions: Indoor 20°C BS. External 7°C BS / 6°C BU. Pipe length 7.5 m, level difference 0 m. (subject to JIS B8615-2)

*3 Values measured in anechoic chamber. Cooling / Heating

*4 GWP of HFC R410A equal to 2088 according to regulation 517 / 2014

*The COP and EER coefficients are system performances and as such do not refer just to the outdoor unit but include both the water production coefficients (Outdoor Unit + Hydronic Unit) and the water distribution coefficients (Hydronic Unit + Indoor units).

Technical specifications

MODEL			PURY-P350YNW-A2 (-BS)	PURY-P400YNW-A2 (-BS)	PURY-P450YNW-A2 (-BS)	PURY-P500YNW-A2 (-BS)	
HP			14	16	18	20	
Power Supply	Tens./Freq./Phases	V/Hz/n°	3-phase 4-wire 380-400-415 V 50/60 Hz				
Cooling	Nominal capacity*1		kW	40,0	45	50,0	56,0
	Power input		kW	16,26	16,65	17,92	24,03
	EER*		kW	2,46	2,70	2,79	2,33
	Temperature operating fields	Indoor BU	°C	15.0~24.0°C (59~75°F)	15.0~24.0°C (59~75°F)	15.0~24.0°C (59~75°F)	15.0~24.0°C (59~75°F)
		Outdoor BS	°C	-5.0~52.0°C (23~126°F)	-5.0~52.0°C (23~126°F)	-5.0~52.0°C (23~126°F)	-5.0~52.0°C (23~126°F)
Heating	Nominal capacity*2		kW	45,0	50,0	56,0	63,0
	Power input		kW	13,88	14,88	17,39	19,09
	COP*		kW	3,24	3,36	3,22	3,30
	Temperature operating fields	Indoor BU	°C	15.0~27.0°C (59~81°F)	15.0~27.0°C (59~81°F)	15.0~27.0°C (59~81°F)	15.0~27.0°C (59~81°F)
		Outdoor BS	°C	-20.0~15.5°C (-4~60°F)	-20.0~15.5°C (-4~60°F)	-20.0~15.5°C (-4~60°F)	-20.0~15.5°C (-4~60°F)
Sound pressure*3		dB(A)	62,5/64,0(81/83)	65,0/69,0 (83/88)	65,5/70,0 (83/89)	63,5/64,5(82/84)	
Connectable int. units.	Model/Quantity		W/WP/WL 10~125/2~50	W/WP/WL 10~125/2~50	W/WP/WL 10~125/2~50	W/WP/WL 10~125/2~50	
Ø refrigerant pipe	Liquid/Gas	mm	19,05/28,58	22,2/28,58	22,2/28,58	22,2/28,58	
External dimensions	(HxLxD)	mm	1,858 (1,798) x 1240 x 740	1,858 (1,798) x 1240 x 740	1,858 (1,798) x 1240 x 740	1,858 (1,798) x 1750 x 740	
Net weight		kg	269	269	289	335	
Refr. charge R410A/CO ₂ Eq		kg/Tons	8/16,70	8/16,70	10,8/22,55	10,8/22,55	

*1 Rated cooling conditions: Indoor 27°C BS / 19°C BU. Outdoor 35°C BS. Pipe length 7.5 m, level difference 0 m. (subject to JIS B8615-2)

*2 Rated heating conditions: Indoor 20°C BS. External 7°C BS / 6°C BU. Pipe length 7.5 m, level difference 0 m. (subject to JIS B8615-2)

*3 Values measured in anechoic chamber. Cooling / Heating

*4 GWP of HFC R410A equal to 2088 according to regulation 517 / 2014

*The COP and EER coefficients are system performances and as such do not refer just to the outdoor unit but include both the water production coefficients (Outdoor Unit + Hydronic Unit) and the water distribution coefficients (Hydronic Unit + Indoor units).

WR2 Line

WATER CONDENSED HEAT RECOVERY OUTDOOR UNIT



Technical specifications

MODEL			PQRY-P200YLM-A1	PQRY-P250YLM-A1	PQRY-P300YLM-A1	PQRY-P300YLM-A1 X2 HBC
HP			8	10	12	12
Power Supply	Tens/Freq./Phases	V/Hz/n°	3 phase 380-400-415V 50Hz			
Cooling	Nominal capacity ¹	kW	22,4	28,0	33,5	33,5
	Power input	kW	3,97	5,44	7,55	6,71
	EER*	kW	5,64	5,14	4,43	4,99
	Temperature operating fields	Indoor BU	°C	15,0~24,0	15,0~24,0	15,0~24,0
Outdoor BS		°C	10,0~45,0	10,0~45,0	10,0~45,0	10,0~45,0
Heating	Nominal capacity ²	kW	25,0	31,5	37,5	37,5
	Power input	kW	4,04	5,41	7,13	6,79
	COP*	kW	6,18	5,82	5,25	5,52
	Temperature operating fields	Indoor BS	°C	15,0~27,0	15,0~27,0	15,0~27,0
Outdoor BU		°C	10,0~45,0	10,0~45,0	10,0~45,0	10,0~45,0
Sound pressure ³		dB(A)	46 (60)	48 (62)	54(68)	54(68)
Connectable int. units.			50~150% of outdoor unit capacity	50~150% of outdoor unit capacity	50~150% of outdoor unit capacity	50~150% of outdoor unit capacity
	Connectable int. units		1~30	1~37	3~45	2~45
Ø refrigerant pipe	Liquid/Gas	mm	15,88/19,05	19,05/22,2	19,05/22,2	19,05/22,2
Water circuit	Norm flow rate	m³/h	5,76	5,76	5,76	5,76
	Water flow rate range	m³/h	3,0-7,2	3,0-7,2	3,0-7,2	3,0-7,2
	Pressure drop	kPa	24	24	24	24
	Heat exch. volume	l	5	5	5	5
External dimensions (HxLxD)			1100 x 880 x 550	1100 x 880 x 550	1100 x 880 x 550	1100 x 880 x 550
Net weight			173	173	172	173
Refr. charge R410A ⁴ /CO ₂ Eq			5/10,44	5/10,44	5/10,44	5/10,44

¹ Rated cooling conditions: Indoor 27°C BS / 19°C BU. Outdoor 35°C BS. Pipe length 7.5 m, level difference 0 m. (subject to JIS B8615-2)

² Rated heating conditions: Indoor 20°C BS. External 7°C BS / 6°C BU. Pipe length 7.5 m, level difference 0 m. (subject to JIS B8615-2)

³ Values measured in anechoic chamber. Cooling / Heating

⁴ GWP of HFC R410A equal to 2088 according to regulation 517 / 2014

*The COP and EER coefficients are system performances and as such do not refer just to the outdoor unit but include both the water production coefficients (Outdoor Unit + Hydronic Unit) and the water distribution coefficients (Hydronic Unit + Indoor units).

**Without removable support feet, A = 1798 mm

Technical specifications

MODEL			PQRY-P350YLM-A1	PQRY-P350YLM-A1 X2 HBC	PQRY-P400YLM-A1	PQRY-P450YLM-A1	PQRY-P500YLM-A1
HP			14	14	16	18	20
Power Supply	Tens/Freq./Phases	V/Hz/n°	3 fasi 380-400-415V 50Hz				
Cooling	Nominal capacity ¹	kW	40,0	40,0	45,0	50,0	56,0
	Power input	kW	9,98	8,72	10,05	12,05	14,58
	EER*	kW	4,00	4,58	4,47	4,14	3,84
	Temperature operating fields	Indoor BU	°C	15,0~24,0	15,0~24,0	15,0~24,0	15,0~24,0
Outdoor BS		°C	10,0~45,0	10,0~45,0	10,0~45,0	10,0~45,0	10,0~45,0
Heating	Nominal capacity ²	kW	45,0	45,0	50,0	56,0	63,0
	Power input	kW	8,87	8,25	9,45	11,11	13,07
	COP*	kW	5,07	5,45	5,29	5,04	4,82
	Temperature operating fields	Indoor BS	°C	15,0~27,0	15,0~27,0	15,0~27,0	15,0~27,0
Outdoor BU		°C	10,0~45,0	10,0~45,0	10,0~45,0	10,0~45,0	10,0~45,0
Sound pressure ³		dB(A)	52(66)	52(66)	52(66)	54(70)	54(70,5)
Connectable int. units.			50~150% of outdoor unit capacity	50~150% of outdoor unit capacity	50~150% of outdoor unit capacity	50~150% of outdoor unit capacity	50~150% of outdoor unit capacity
	Connectable int. units		2~50	2~50	2~50	2~50	5~50
Ø refrigerant pipe	Liquid/Gas	mm	22,2/28,58	22,2/28,58	22,2/28,58	22,2/28,58	22,2/28,58
Water circuit	Norm flow rate	m³/h	7,20	7,20	7,20	7,20	7,20
	Water flow rate range	m³/h	4,5-11,6	4,5-11,6	4,5-11,6	4,5-11,6	4,5-11,6
	Pressure drop	kPa	44	44	44	44	44
	Heat exch. volume	l	5	5	5	5	5
External dimensions (HxLxD)			mm 1450 x 880 x 550	1450 x 880 x 550	1450 x 880 x 550	1450 x 880 x 550	1450 x 880 x 550
Net weight			kg 217	217	217	217	217
Refr. charge R410A ⁴ /CO ₂ Eq			kg/Tons 6/12,53	6/12,53	6/12,53	6/12,53	6/12,53

¹ Rated cooling conditions: Indoor 27°C BS / 19°C BU. Outdoor 35°C BS. Pipe length 7.5 m, level difference 0 m. (subject to JIS B8615-2)

² Rated heating conditions: Indoor 20°C BS. External 7°C BS / 6°C BU. Pipe length 7.5 m, level difference 0 m. (subject to JIS B8615-2)

³ Values measured in anechoic chamber. Cooling / Heating

⁴ GWP of HFC R410A equal to 2088 according to regulation 517 / 2014

*The COP and EER coefficients are system performances and as such do not refer just to the outdoor unit but include both the water production coefficients (Outdoor Unit + Hydronic Unit) and the water distribution coefficients (Hydronic Unit + Indoor units).

**Without removable support feet, A = 1798 mm

Main HBC Controller

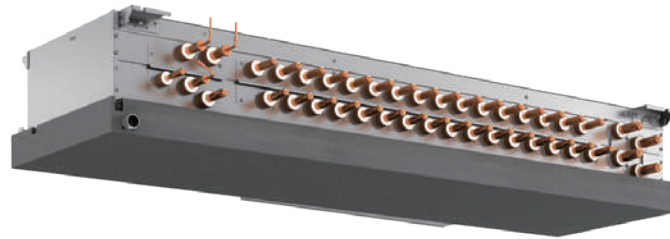

R410A

Technical specifications

MODEL		CMB-WM108V-AA	CMB-WM1016V-AA
Number of branches		8 (22mm OD pipe)	16 (22mm OD pipe)
Net weight	kg	86	98
Weight with water	kg	96	111
Dimensions	Width	1520	1800
	Depth	630	630
	Height	300	300
Power supply		220-240V, 50Hz	220-240V, 50Hz
Phase		1	1
Power input	kW	0.46	0.46
Current	A	2.83	2.83

CMB-WM-V-AA e CMB-WM-V-BB units are to be used exclusively with outdoor units PURY-P200-500YNW-A1(2), PQRY-P200-500YLM-A1 and HVRF indoor units (W/WL/WP)
 One HBC Main can be used with PURY-P200-350YNW-A, PQRY-P200-350YLM-A.
 Two HBC Main can be used with PURY-P300-350YNW-A, PQRY-P300-350YLM-A.
 Two HBC Main must be used with PURY-P400-500YNW-A, PQRY-P400-500YLM-A.

Sub HBC Controller

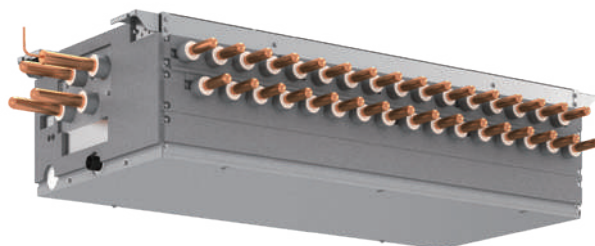

R410A

Technical specifications

MODEL			CMB-WM108V-BB	CMB-WM1016V-BB
Number of branches			8 (22mm OD pipe)	16 (22mm OD pipe)
Net weight		kg	40	53
Weight with water		kg	45	62
Dimensions	Width	mm	930	1210
	Depth	mm	630	630
	Height	mm	310	310
Power supply			220-240V 50Hz	220-240V, 50Hz
Phase			1	1
Power input		kW	0.01	0.01
Current		A	0.14	0.14

CMB-WM-V-AA e CMB-WM-V-BB units are to be used exclusively with outdoor units PURY-P200-500YNW-A1(2), PQRY-P200-500YLM-A1 and HVRF indoor units (W/WL/WP)



Design guide

HVRF Hydronic Heat Recovery systems

1 HBC Main

Item	Circuit section	Maximum length (m)
Effective length between outdoor unit and HBC Main distributor	A	110
Effective length between HBC distributor and indoor unit	b	60
Height difference between OU and HBC Main (OU above HBC Main)	H	50
Height difference between OU and HBC Main (OU below HBC Main)	H'	40
Difference in height between Indoor unit and HBC distributor	h1	15
Difference in height between indoor units	h2	15

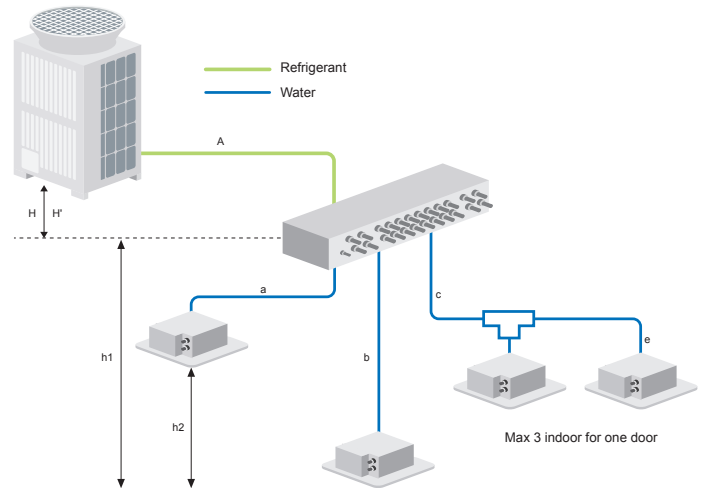

1 HBC Main e 1 HBC Sub

Item	Circuit section	Maximum length (m)
Effective length between outdoor unit and HBC Main distributor	A	110
Effective length between HBC distributor and indoor unit	f+g	60
Height difference between OU and HBC Main (OU above HBC Main)	H	50
Height difference between OU and HBC Main (OU below HBC Main)	H'	40
Difference in height between indoor unit and HBC distributor	h1	15
Difference in height between indoor units	h2	15

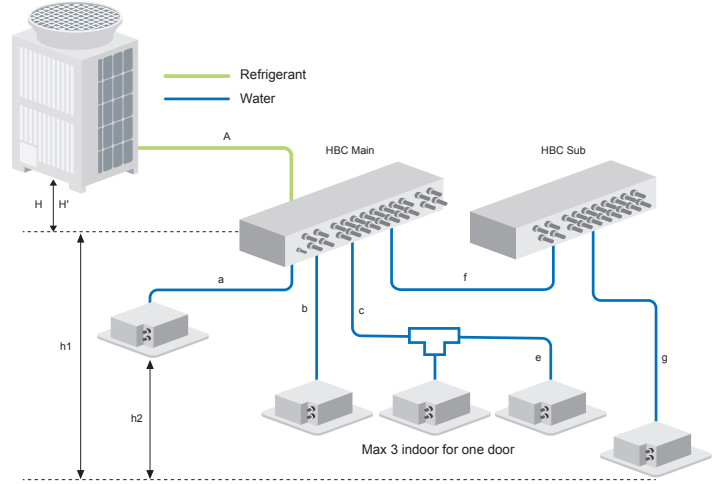

2 HBC Main e 1 HBC Sub

Item	Circuit section	Maximum length (m)
Effective length between outdoor unit and HBC Main distributor	A+B	110
Effective length between HBC distributor and indoor unit	b e (g + h)	60
Height difference between OU and HBC Main (OU above HBC Main)	H	50
Height difference between OU and HBC Main (OU below HBC Main)	H'	40
Difference in height between indoor unit and HBC distributor	h1	15
Difference in height between indoor units	h2	15
Difference in height between HBC Main and HBC Main	h3	15
Length between HBC Main and HBC Main	C	40

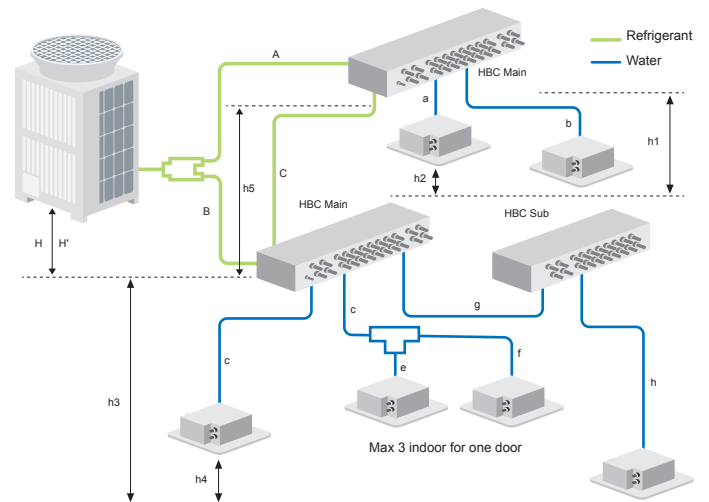

HVRF Systems Line

Indoor units

Ceiling concealed indoor units

PEFY-W VMS-A Medium to low static pressure 202

PEFY-W VMA-A Medium to high static pressure 204

Ceiling cassette indoor units

PLFY-WL VEM-E 4 way airflow type 206

PLFY-WL VFM-E 4 way airflow compact type 207

Floor standing indoor units

PFFY-W VCM-A 208

Wall mounted indoor units

PKFY-WL VLM-E 210



HYDRONICVRF

PEFY-W VMS-A

INDOOR UNITS - Ceiling concealed medium to low static pressure



VALVE
INCLUDED

Technical specifications

MODEL			PEFY-W10VMS-A	PEFY-W15VMS-A	PEFY-W20VMS-A	PEFY-W25VMS-A
Power source			1-phase 220-240 V 50 Hz	1-phase 220-240 V 50 Hz	1-phase 220-240 V 50Hz	1-phase 220-240 V 50Hz
Cooling capacity*1		kW	1.2	1.7	2.2	2.8
		BTU/h	4,100	5,800	7,500	9,600
Heating capacity*1		kW	1.4	1.9	2.5	3.2
		BTU/h	4,800	6,500	8,500	10,900
Power input	Cooling	kW	0.020	0.025	0.030	0.035
	Heating	kW	0.020	0.025	0.030	0.035
External finish			Galvanized steel plate	Galvanized steel plate	Galvanized steel plate	Galvanized steel plate
External dimension		HxWxD	200 x 790 x 700	200 x 790 x 700	200 x 790 x 700	200 x 790 x 700
Net weight		kg	19 (42)	19 (42)	19 (42)	19 (42)
Heat exchanger			Cross fin (Aluminum fin and copper tube)			
FAN	Type x Quantity		Sirocco fan x 2	Sirocco fan x 2	Sirocco fan x 2	Sirocco fan x 2
	External static press.*2	Pa	<5> - 15 - <35> - <50>	<5> - 15 - <35> - <50>	<5> - 15 - <35> - <50>	<5> - 15 - <35> - <50>
	Air flow rate		(Low-Mid-High)	(Low-Mid-High)	(Low-Mid-High)	(Bassa - Media - Alta)
		m3/min	4.0 - 4.5 - 5.0	5.0 - 5.5 - 7.0	5.5 - 6.5 - 7.5	5.5 - 6.5 - 8.5
Motor	Type		Motore DC	Motor DC	Motor DC	Motor DC
	Output	kW	0.096	0.096	0.096	0.096
Sound pressure level			(Low-Mid-High)	(Low-Mid-High)	(Low-Mid-High)	(Low-Mid-High)
		dB <A>	20-22-23	22-24-25	23-24-26	23-24-28
Air filter			PP honeycomb fabric	PP honeycomb fabric	PP honeycomb fabric	PP honeycomb fabric
Water piping diameter	Inlet	mm I.D.	20	20	20	20
	Outlet	mm I.D.	20	20	20	20
Field drain pipe size		mm	O.D.32 (1-1/4)	O.D.32 (1-1/4)	O.D.32 (1-1/4)	O.D.32 (1-1/4)

*1 The heating/cooling capacity indicates the maximum value during operation under the following conditions:

Cooling: indoor 27°C DB / 19°C WBT, outdoor 35°C DB. Heating: indoor 20°C DB, outdoor 7°C DB. Length of pipes: 7.5 m. Height difference: 0 m.

*2 The external static pressure is factory set to 15 Pa for the PEFY-W VMS-A model

The HVRF **W** indoor units can be connected to both **HVRF Y** and **R2** systems.

Technical specifications					
MODEL			PEFY-W32VMS-A	PEFY-W40VMS-A	PEFY-W50VMS-A
Power source			1-phase 220-240 V 50 Hz	1-phase 220-240 V 50 Hz	1-phase 220-240 V 50Hz
Cooling capacity*1		kW	3.6	4.5	5.6
		BTU/h	12,300	15,400	19,100
Heating capacity*1		kW	4.0	5.0	6.3
		BTU/h	13,600	17,100	21,500
Power input	Cooling	kW	0.040	0.045	0.070
	Heating	kW	0.040	0.045	0.070
External finish			Galvanized steel plate	Galvanized steel plate	Galvanized steel plate
External dimension		HxWxD	200 x 790 x 700	200 x 990 x 700	200 x 990 x 700
Net weight		kg	19.5 (45)	23.5 (53)	23.5 (53)
Heat exchanger			Cross fin (Aluminum fin and copper tube)		
FAN	Type x Quantity		Sirocco fan x 2	Sirocco fan x 3	Sirocco fan x 3
	External static press.*2	Pa	<5> - 15 - <35> - <50>	<5> - 15 - <35> - <50>	<5> - 15 - <35> - <50>
	Air flow rate		(Low-Mid-High)	(Low-Mid-High)	(Low-Mid-High)
		m3/min	5.5 - 6.5 - 9.0	8.0 - 9.5 - 11.0	9.5 - 12.0 - 14.5
Motor	Type		Motor DC	Motor DC	Motor DC
	Output	kW	0.096	0.096	0.096
Sound pressure level		dB <A>	(Low-Mid-High) 24-25-31	(Low-Mid-High) 24-25-28	(Low-Mid-High) 25-29-33
Air filter			PP honeycomb fabric	PP honeycomb fabric	PP honeycomb fabric
Water piping diameter	Inlet	mm I.D.	20	20	20
	Outlet	mm I.D.	20	20	20
Field drain pipe size		mm	O.D.32 (1-1/4)	O.D.32 (1-1/4)	O.D.32 (1-1/4)

*1 The heating/cooling capacity indicates the maximum value during operation under the following conditions:
Cooling: indoor 27°C DB / 19°C WBT, outdoor 35°C DB. Heating: indoor 20°C DB, outdoor 7°C DB. Length of pipes: 7.5 m. Height difference: 0 m.
*2 The external static pressure is factory set to 15 Pa for the PEFY-W VMS-A model.
The HVRF W indoor units can be connected to both HVRF Y and R2 systems.

Indoor unit	Connectivity with outdoor unit
W Model	R2 + HBC Series Y Series + Idronic Unit

The table below summarizes the connectivity between different combinations of indoor units for HVRF - R2 systems

HVRF-R2 outdoor unit	Indoor unit			Connectivity
	A	B	C	
	WLV	W	-	Connectible
	WLV	WL	W	Not connectible
	WLV	W	WP	Not connectible
	WL	W	-	Not connectible
	WL	WP	W	Not connectible
	W	WP	-	Not connectible

WLV = Indoor Unit Type WL with optional valve kit
 WL = Indoor Unit Type WL without optional valve kit
 WP = Indoor Unit Type WP (without integrated valve and not compatible with the optional valve kit)
 W = Indoor Unit Type W (With integrated valve)

In an HVRF-R2 system, if a valve kit is connected to any of the WL indoor units, all other indoor units must also have a valve.
 The valve kit is required to use the HVRF-Y system.

PEFY-W VMA-A

INDOOR UNITS - Ceiling concealed medium to high static pressure

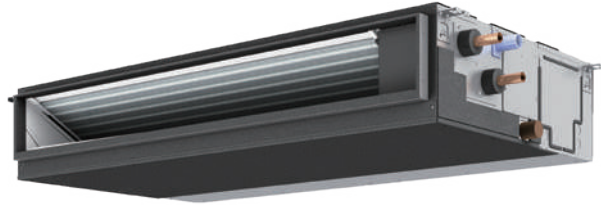

VALVE
INCLUDED

Technical specifications

MODEL			PEFY-W20VMA-A	PEFY-W25VMA-A	PEFY-W32VMA-A	PEFY-W40VMA-A	PEFY-W50VMA-A	
Power source			1-phase 220-240 V 50 Hz	1-phase 220-240 V 50 Hz	1-phase 220-240 V 50Hz	1-phase 220-240 V 50Hz	1-phase 220-240 V 50Hz	
Cooling capacity*1		kW	2.2	2.8	3.6	4.5	5.6	
		BTU/h	7,500	9,600	12,300	15,400	19,100	
Heating capacity*1		kW	2.5	3.2	4.0	5.0	6.3	
		BTU/h	8,500	10,900	13,600	17,100	21,500	
Power input	Cooling	kW	0.032	0.032	0.044	0.047	0.093	
	Heating	kW	0.030	0.030	0.042	0.045	0.091	
External finish			Galvanized steel plate	Galvanized steel plate	Galvanized steel plate	Galvanized steel plate	Galvanized steel plate	
External dimension		HxWxD	250 x 700 x 732			250 x 900 x 732		250 x 1,100 x 732
Net weight		kg	22 (49)	22 (49)	22 (49)	26 (58)	30 (67)	
Heat exchanger			Cross fin (Aluminum fin and copper tube)					
FAN	Type x Quantity		Sirocco fan x 1	Sirocco fan x 1	Sirocco fan x 2	Sirocco fan x 2	Sirocco fan x 2	
	External static press.*2	Pa	35 - <50> - <70> - <100> - <150>					
	Air flow rate		(Low-Mid-High)	(Low-Mid-High)	(Low-Mid-High)	(Low-Mid-High)	(Low-Mid-High)	
		m3/min	6.0 - 7.5 - 8.5	6.0 - 7.5 - 8.5	7.5 - 9.0 - 10.5	10.0 - 12.0 - 14.0	14.5 - 18.0 - 21.0	
Motor	Type		Motor DC	Motor DC	Motor DC	Motor DC	Motor DC	
	Output	kW	0.085	0.085	0.085	0.121	0.121	
Sound pressure level			(Low-Mid-High)	(Low-Mid-High)	(Low-Mid-High)	(Low-Mid-High)	(Low-Mid-High)	
		dB <A>	21-25-27	21-25-27	23-27-30	23-28-31	26-31-35	
Air filter			PP honeycomb fabric					
Water piping diameter	Inlet	mm I.D.	20	20	20	20	20	
	Outlet	mm I.D.	20	20	20	20	20	
Field drain pipe size		mm	O.D.32(1-1/4)	O.D.32(1-1/4)	O.D.32(1-1/4)	O.D.32(1-1/4)	O.D.32(1-1/4)	

*1 The heating/cooling capacity indicates the maximum value during operation under the following conditions:

Cooling: indoor 27°C DB / 19°C WBT, outdoor 35°C DB. Heating: indoor 20°C DB, outdoor 7°C DB. Length of pipes: 7.5 m. Height difference: 0 m.

*2 The external static pressure is factory set to 15 Pa for the PEFY-W VMA-A model.

The HVRF **W** indoor units can be connected to both **HVRF Y** and **R2** systems.

Technical specifications				PEFY-W63VMA-A	PEFY-W71VMA-A	PEFY-W80VMA-A	PEFY-W100VMA-A	PEFY-W125VMA-A
MODEL								
Power source			1-phase 220-240 V 50 Hz	1-phase 220-240 V 50 Hz	1-phase 220-240 V 50Hz	1-phase 220-240 V 50Hz	1-phase 220-240 V 50Hz	1-phase 220-240 V 50Hz
Cooling capacity*1		kW	7.1	8.0	9.0	11.2	14.0	
		BTU/h	24,200	27,300	30,700	38,200	47,800	
Heating capacity*1		kW	8.0	9.0	10.0	12.5	16.0	
		BTU/h	27,300	30,700	34,100	42,700	54,600	
Power input	Cooling	kW	0.093	0.093	0.093	0.142	0.199	
	Heating	kW	0.091	0.091	0.091	0.140	0.197	
External finish			Galvanized steel plate	Galvanized steel plate	Galvanized steel plate	Galvanized steel plate	Lamiera in acciaio galvanizzato	
External dimension		HxWxD	250 x 1,100 x 732			250 x 1,400 x 732		
Net weight		kg	30 (67)	30 (67)	30 (67)	37 (82)	38 (84)	
Heat exchanger			Cross fin (Aluminum fin and copper tube)					
FAN	Type x Quantity		Sirocco fan x 2	Sirocco fan x 2	Sirocco fan x 3	Sirocco fan x 3	Sirocco fan x 3	
	External static press.*2	Pa	40 - <50> - <70> - <100> - <150>	(Low-Mid-High)	(Low-Mid-High)	(Low-Mid-High)	(Low-Mid-High)	
	Air flow rate	m3/min	14.5 - 18.0 - 21.0	14.5 - 18.0 - 21.0	14.5 - 18.0 - 21.0	23.0 - 28.0 - 32.0	28.0 - 34.0 - 37.0	
Motor	Type		Motore DC	Motore DC	Motore DC	Motore DC	Motore DC	
	Output	kW	0.121	0.121	0.121	0.300	0.300	
Sound pressure level		dB <A>	(Low-Mid-High) 26-31-35	(Low-Mid-High) 26-31-35	(Low-Mid-High) 26-31-35	(Low-Mid-High) 30-35-38	(Low-Mid-High) 34-38-40	
Air filter			PP honeycomb fabric					
Water piping diameter	Inlet	mm I.D.	30	30	30	30	30	
	Outlet	mm I.D.	30	30	30	30	30	
Field drain pipe size		mm	O.D.32(1-1/4)	O.D.32(1-1/4)	O.D.32(1-1/4)	O.D.32(1-1/4)	O.D.32(1-1/4)	

*1 The heating/cooling capacity indicates the maximum value during operation under the following conditions:
 Cooling: indoor 27°C DB / 19°C WBT, outdoor 35°C DB. Heating: indoor 20°C DB, outdoor 7°C DB. Length of pipes: 7.5 m. Height difference: 0 m.
 *2 The external static pressure is factory set to 15 Pa for the PEFY-W VMA-A model.
 The HVRF W indoor units can be connected to both HVRF Y and R2 systems.

Indoor unit	Connectivity with outdoor unit
W Model	R2 + HBC Series Y Series + Idronic Unit

The table below summarizes the connectivity between different combinations of indoor units for HVRF - R2 systems

HVRF-R2 outdoor unit	Indoor unit			Connectivity
	A	B	C	
	WLV	W	-	Connectible
	WLV	WL	W	Not connectible
	WLV	W	WP	Not connectible
	WL	W	-	Not connectible
	WL	WP	W	Not connectible
	W	WP	-	Not connectible

WLV = Indoor Unit Type WL with optional valve kit
 WL = Indoor Unit Type WL without optional valve kit
 WP = Indoor Unit Type WP (without integrated valve and not compatible with the optional valve kit)
 W = Indoor Unit Type W (With integrated valve)

In an HVRF-R2 system, if a valve kit is connected to any of the WL indoor units, all other indoor units must also have a valve.
 The valve kit is required to use the HVRF-Y system.

PLFY-WL VEM-E

INDOOR UNITS - 4-way cassette 900x900



VALVE
EXCLUDED

Technical specifications

MODEL			PLFY-WL32VEM-E	PLFY-WL40VEM-E	PLFY-WL50VEM-E
Power source			1-phase 220-240 V 50 Hz, 1-phase 220 V 60 Hz	1-phase 220-240 V 50 Hz, 1-phase 220 V 60 Hz	1-phase 220-240 V 50 Hz, 1-phase 220 V 60 Hz
Cooling capacity*1		kW	3.6	4.5	5.6
		BTU/h	12,300	15,400	19,100
Heating capacity*1		kW	4.0	5.0	6.3
		BTU/h	13,600	17,100	21,500
Power input	Cooling	kW	0.03	0.03	0.04
	Heating	kW	0.03	0.03	0.04
External finish			Galvanized steel plate	Galvanized steel plate	Galvanized steel plate
External dimension		HxWxD	258 × 840 × 840	258 × 840 × 840	258 × 840 × 840
Net weight		kg	20 (44)	20 (44)	20 (44)
Heat exchanger			Cross fin (Al fin and Cu pipe)		
FAN	Type x Quantity		Turbo fan × 1	Turbo fan × 1	Turbo fan × 1
	External static press.**	Pa	-	-	-
	Air flow rate		(Low-Mid-High)	(Low-Mid-High)	(Low-Mid-High)
		m3/min	14-15-16-17	14-15-16-17	14-16-18-20
Motor	Type		Motor DC		
	Output	kW	0.050	0.050	0.050
Sound pressure level			(Low-Mid-High)	(Low-Mid-High)	(Low-Mid-High)
		dB <A>	26-27-29-30	26-28-29-31	27-29-31-33
Air filter			PP honeycomb fabric		
Water piping diameter	Inlet	mm I.D.	20	20	20
	Outlet	mm I.D.	20	20	20
Field drain pipe size		mm	O.D.32 (1-1/4)	O.D.32 (1-1/4)	O.D.32 (1-1/4)

*1 The heating/cooling capacity indicates the maximum value during operation under the following conditions:
Cooling: indoor 27°C DB / 19°C WBT, outdoor 35°C DB. Heating: indoor 20°C DB, outdoor 7°C DB. Length of pipes: 7.5 m. Height difference: 0 m.
The HVRF WL indoor units can be connected to both HVRF Y and R2 systems.

Indoor unit	Connectivity with outdoor unit
WL Model	R2 + HBC Series Y Series + Idronic Unit

Valve kit specifications			
Model	PAC-SK35VK-E		
Dimensions	H × W × D	mm	549 × 201 × 107
Net weight	kg	kg	3.5
Water piping diameter	Inlet	mm I.D.	20
	Outlet	mm I.D.	20

*PAC-SK04VK-E phase-out after stock end

The table below summarizes the connectivity between different combinations of indoor units for HVRF - R2 systems

HVRF-R2 outdoor unit	Indoor unit			Connectivity
	A	B	C	
	WLV	WLV	-	Connectible
	WLV	W	-	Connectible
	WLV	WL	-	Not connectible
	WLV	WP	-	Not connectible
	WLV	WL	W	Not connectible
	WLV	WL	WP	Not connectible
	WLV	W	WP	Not connectible
	WL	WL	-	Connectible
	WL	WP	-	Connectible
	WL	W	-	Not connectible
	WL	WP	W	Not connectible

WLV = Indoor Unit Type WL with optional valve kit
WL = Indoor Unit Type WL without optional valve kit
WP = Indoor Unit Type WP (without integrated valve and not compatible with the optional valve kit)
W = Indoor Unit Type W (With integrated valve)



In an HVRF-R2 system, if a valve kit is connected to any of the WL indoor units, all other indoor units must also have a valve.
The valve kit is required to use the HVRF-Y system.

PLFY-WL VFM-E

INDOOR UNITS - 4-way cassette 600x600



VALVE
EXCLUDED

Technical specifications

MODEL			PLFY-WL10VFM-E	PLFY-WL15VFM-E	PLFY-WL20VFM-E	PLFY-WL25VFM-E	PLFY-WL32VFM-E
Power source			1-phase 220-240 V 50 Hz, 1-phase 220 V 60 Hz	1-phase 220-240 V 50 Hz, 1-phase 220 V 60 Hz	1-phase 220-240 V 50 Hz, 1-phase 220 V 60 Hz	1-phase 220-240 V 50 Hz, 1-phase 220 V 60 Hz	1-phase 220-240 V 50 Hz, 1-phase 220 V 60 Hz
Cooling capacity*1		kW	1.2	1.7	2.2	2.8	3.6
		BTU/h	4,100	5,800	7,500	9,600	12,300
Heating capacity*1		kW	1.4	1.9	2.5	3.2	4.0
		BTU/h	4,800	6,500	8,500	10,900	13,600
Power input	Cooling	kW	0.02	0.02	0.02	0.03	0.04
	Heating	kW	0.02	0.02	0.02	0.03	0.04
External finish			Galvanized steel plate				
External dimension		HxWxD	208 × 570 × 570				
Net weight		kg	13 (29)	13 (29)	14 (31)	14 (31)	14 (31)
Heat exchanger			Cross fin (Al fin and Cu pipe)				
FAN	Type x Quantity		Turbo fan × 1	Turbo fan × 1	Turbo fan × 1	Turbo fan × 1	Turbo fan × 1
	External static press.*2	Pa	-	-	-	-	-
	Air flow rate	m3/min	(Low-Mid-High) 6.0-6.5-7.0	(Low-Mid-High) 6.0-7.0-8.0	(Low-Mid-High) 6.5-7.0-8.0	(Low-Mid-High) 6.5-7.5-9.0	(Low-Mid-High) 6.5-9.0-12.0
Motor	Type		Motore DC	Motore DC	Motore DC	Motore DC	Motore DC
	Output	kW	0.050	0.050	0.050	0.050	0.050
Sound pressure level			(Low-Mid-High)	(Low-Mid-High)	(Low-Mid-High)	(Low-Mid-High)	(Low-Mid-High)
		dB <A>	25-26-27	25-26-29	27-29-31	27-30-34	27-33-41
Air filter			PP honeycomb fabric				
Water piping diameter	Inlet	mm I.D.	20	20	20	20	20
	Outlet	mm I.D.	20	20	20	20	20
Field drain pipe size		mm	O.D.32 (1-1/4)	O.D.32 (1-1/4)	O.D.32 (1-1/4)	O.D.32 (1-1/4)	O.D.32 (1-1/4)

*1 The heating/cooling capacity indicates the maximum value during operation under the following conditions:
Cooling: indoor 27°C DB / 19°C WBT, outdoor 35°C DB. Heating: indoor 20°C DB, outdoor 7°C DB. Length of pipes: 7.5 m. Height difference: 0 m.
The HVRF WL indoor units can be connected to both HVRF Y and R2 systems.

Indoor unit	Connectivity with outdoor unit
WL Model	R2 + HBC Series Y Series + Idronic Unit

The table below summarizes the connectivity between different combinations of indoor units for HVRF - R2 systems

HVRF-R2 outdoor unit	Indoor unit			Connectivity
	A	B	C	
	WLV	WLV	-	Connectible
	WLV	W	-	Connectible
	WLV	WL	-	Not connectible
	WLV	WP	-	Not connectible
	WLV	WL	W	Not connectible
	WLV	WL	WP	Not connectible
	WLV	W	WP	Not connectible
	WL	WL	-	Connectible
	WL	WP	-	Connectible
	WL	W	-	Not connectible
	WL	WP	W	Not connectible

In an HVRF-R2 system, if a valve kit is connected to any of the WL indoor units, all other indoor units must also have a valve.
The valve kit is required to use the HVRF-Y system.

WLV = Indoor Unit Type WL with optional valve kit
WL = Indoor Unit Type WL without optional valve kit
WP = Indoor Unit Type WP (without integrated valve and not compatible with the optional valve kit)
W = Indoor Unit Type W (With integrated valve)



Valve kit specifications

Model			PAC-SK35VK-E
Dimensions	H × W × D	mm	549 × 201 × 107
Net weight		kg	3.5
		kg	
Water piping diameter	Inlet	mm I.D.	20
	Outlet	mm I.D.	20

*PAC-SK04VK-E phase-out after stock end

PFFY-W VCM-A

INDOOR UNITS - Floor standing concealed



VALVE INCLUDED

Technical specifications

MODEL			PFFY-W20VCM-A	PFFY-W25VCM-A	PFFY-W32VCM-A	PFFY-W40VCM-A	PFFY-W50VCM-A
Power source			1-phase 220-240 V 50 Hz	1-phase 220-240 V 50 Hz	1-phase 220-240 V 50Hz	1-phase 220-240 V 50 Hz	1-phase 220-240 V 50 Hz
Cooling capacity*1		kW	2.2	2.8	3.6	4.5	5.6
		BTU/h	7,500	9,600	12,300	15,400	19,100
Heating capacity*1		kW	2.5	3.2	4.0	5.0	6.3
		BTU/h	8,500	10,900	13,600	17,100	21,500
Power input	Cooling	kW	0.022	0.029	0.035	0.038	0.062
	Heating	kW	0.022	0.029	0.035	0.038	0.062
External finish			Galvanized steel plate				
External dimension		HxWxD	615 (690) x 700 x 200	615 (690) x 700 x 200	615 (690) x 700 x 200	615 (690) x 900 x 200	615 (690) x 900 x 200
Net weight		kg	18.5 (42)	18.5 (42)	19 (42)	23 (51)	23 (51)
Heat exchanger			Cross fin (Al fin and Cu pipe)				
FAN	Type x Quantity		Sirocco fan x 2	Sirocco fan x 2	Sirocco fan x 2	Sirocco fan x 3	Sirocco fan x 3
	External static press.*2	Pa	<0> - 10 - <40> - <60>	<0> - 10 - <40> - <60>	<0> - 10 - <40> - <60>	<0> - 10 - <40> - <60>	<0> - 10 - <40> - <60>
	Air flow rate		(Low-Mid-High)	(Low-Mid-High)	(Low-Mid-High)	(Low-Mid-High)	(Low-Mid-High)
		m3/min	5.0 - 6.0 - 7.0	5.5 - 7.0 - 8.5	6.5 - 7.5 - 9.0	8.0 - 9.5 - 11.0	10.5 - 12.5 - 14.5
Motor	Type		Motor DC				
	Output	kW	0.096	0.096	0.096	0.096	0.096
Sound pressure level			(Low-Mid-High)	(Low-Mid-High)	(Low-Mid-High)	(Low-Mid-High)	(Low-Mid-High)
		dB <A>	21-23-26	22-26-30	25-28-32	25-27-30	28-32-35
Air filter			PP honeycomb fabric				
Water piping diameter	Inlet	mm I.D.	20	20	20	20	20
	Outlet	mm I.D.	20	20	20	20	20
Field drain pipe size		mm	O.D.32 (1-1/4)	O.D.32 (1-1/4)	O.D.32 (1-1/4)	O.D.32 (1-1/4)	O.D.32 (1-1/4)

*1 The heating/cooling capacity indicates the maximum value during operation under the following conditions:

Cooling: indoor 27°C DB / 19°C WBT, outdoor 35°C DB. Heating: indoor 20°C DB, outdoor 7°C DB. Length of pipes: 7.5 m. Height difference: 0 m.

*2 The external static pressure is factory set to 20 Pa for the PFFY-WP VLRMM-E Model.

The HVRF **W** indoor units can be connected to both **HVRF Y** and **R2** systems.
Indoor unit connections 3/4" thread.

Indoor unit	Connectivity with outdoor unit
W Model	R2 + HBC Series Y Series + Idronic Unit

The table below summarizes the connectivity between different combinations of indoor units for HVRF - R2 systems

HVRF-R2 outdoor unit	Indoor unit			Connectivity
	A	B	C	
	WLV	W	-	Connectible
	WLV	WL	W	Not connectible
	WLV	W	WP	Not connectible
	WL	W	-	Not connectible
	WL	WP	W	Not connectible
	W	WP	-	Not connectible

WLV = Indoor Unit Type WL with optional valve kit

WL = Indoor Unit Type WL without optional valve kit

WP = Indoor Unit Type WP (without integrated valve and not compatible with the optional valve kit)

W = Indoor Unit Type W (With integrated valve)

In an HVRF-R2 system, if a valve kit is connected to any of the WL indoor units, all other indoor units must also have a valve.
The valve kit is required to use the HVRF-Y system.



PKFY-WL VLM-E

INDOOR UNITS - Wall-mounted



VALVE
EXCLUDED

Technical specifications

MODEL			PKFY-WL10VLM-E	PKFY-WL15VLM-E	PKFY-WL20VLM-E
Power source			1-phase 220-240 V 50 Hz, 1-phase 220 V 60 Hz	1-phase 220-240 V 50 Hz, 1-phase 220 V 60 Hz	1-phase 220-240 V 50 Hz, 1-phase 220 V 60 Hz
Cooling capacity*1		kW	1.2	1.7	2.2
		BTU/h	4,100	5,800	7,500
Heating capacity*1		kW	1.4	1.9	2.5
		BTU/h	4,800	6,500	8,500
Power input	Cooling	kW	0.02	0.02	0.03
	Heating	kW	0.01	0.01	0.02
External finish			Galvanized steel plate		
External dimension		HxWxD	299 × 773 × 237		
Net weight		kg	11(25)	11(25)	11(25)
Heat exchanger			Cross fin (Al fin and Cu pipe)		
FAN	Type x Quantity		Line flow fan x 1	Line flow fan x 1	Line flow fan x 1
	External static press.*2	Pa	-	-	-
	Air flow rate	m3/min	(Low-Mid-High) 3.3 - 3.8 - 4.1 - 4.5	(Low-Mid-High) 3.3 - 3.8 - 4.3 - 4.9	(Low-Mid-High) 4.0 - 5.0 - 6.0 - 7.0
Motor	Type		Motor DC		
	Output	kW	0.030	0.030	0.030
Sound pressure level			(Low-Mid-High)	(Low-Mid-High)	(Low-Mid-High)
		dB <A>	22-26-28-30	22-26-29-32	22-28-33-36
Air filter			PP honeycomb fabric		
Water piping diameter	Inlet	mm I.D.	Rc 3/4 screw	Rc 3/4 screw	Rc 3/4 screw
	Outlet	mm I.D.	Rc 3/4 screw	Rc 3/4 screw	Rc 3/4 screw
Field drain pipe size		mm	I.D.16 (5/8)	I.D.16 (5/8)	I.D.16 (5/8)

*1 The heating/cooling capacity indicates the maximum value during operation under the following conditions:
Cooling: indoor 27°C DB / 19°C WBT, outdoor 35°C DB. Heating: indoor 20°C DB, outdoor 7°C DB. Length of pipes: 7.5 m. Height difference: 0 m.
The HVRF **WL** indoor units can be connected to both **HVRF Y** and **R2** systems.

Technical specifications					
MODEL			PKFY-WL25VLM-E	PKFY-WL32VLM-E	PKFY-WL40VLM-E
Power source			1-phase 220-240 V 50 Hz, 1-phase 220 V 60 Hz	1-phase 220-240 V 50 Hz, 1-phase 220 V 60 Hz	1-phase 220-240 V 50 Hz, 1-phase 220 V 60 Hz
Cooling capacity*1		kW	2.8	3.6	4.5
		BTU/h	9,600	12,300	15,400
Heating capacity*1		kW	3.2	4.0	5.0
		BTU/h	10,900	13,600	17,100
Power input	Cooling	kW	0.04	0.04	0.05
	Heating	kW	0.03	0.03	0.04
External finish	Galvanized steel plate				
External dimension		HxWxD	299 × 773 × 237		299 × 898 × 237
Net weight		kg	11(25)	13(29)	13(29)
Heat exchanger	Cross fin (Al fin and Cu pipe)				
FAN	Type x Quantity		Line flow fan x 1	Line flow fan x 1	Line flow fan x 1
	External static press.*2	Pa	-	-	-
	Air flow rate	m3/min	(Low-Mid-High) 3.3 - 3.8 - 4.1 - 4.5	(Low-Mid-High) 6.3 - 7.6 - 9.0 - 10.4	(Low-Mid-High) 6.4 - 8.2 - 10.0 - 11.9
Motor	Type		Motor DC		
	Output	kW	0.030	0.030	0.030
Sound pressure level			(Low-Mid-High) 22-26-28-30	(Low-Mid-High) 29-34-38-41	(Low-Mid-High) 30-36-41-45
Air filter	PP honeycomb fabric				
Water piping diameter	Inlet	mm I.D.	Rc 3/4 screw	Rc 3/4 screw	Rc 3/4 screw
	Outlet	mm I.D.	Rc 3/4 screw	Rc 3/4 screw	Rc 3/4 screw
Field drain pipe size		mm	I.D.16 (5/8)	I.D.16 (5/8)	I.D.16 (5/8)

*1 The heating/cooling capacity indicates the maximum value during operation under the following conditions:
Cooling: indoor 27°C DB / 19°C WBT, outdoor 35°C DB. Heating: indoor 20°C DB, outdoor 7°C DB. Length of pipes: 7.5 m. Height difference: 0 m.
The HVRF WL indoor units can be connected to both HVRF Y and R2 systems.

Indoor unit	Connectivity with outdoor unit
WL Model	R2 + HBC Series Y Series + Idronic Unit

Valve kit specifications			
Model	PAC-SK35VK-E		
Dimensions	H × W × D	mm	549 × 201 × 107
Net weight	kg	kg	3.5
Water piping diameter	Inlet	mm I.D.	20
	Outlet	mm I.D.	20

*PAC-SK04VK-E phase-out after stock end

The table below summarizes the connectivity between different combinations of indoor units for HVRF - R2 systems

HVRF-R2 outdoor unit	Indoor unit			Connectivity
	A	B	C	
	WLV	WLV	-	Connectible
	WLV	W	-	Connectible
	WLV	WL	-	Not connectible
	WLV	WP	-	Not connectible
	WLV	WL	W	Not connectible
	WLV	WL	WP	Not connectible
	WLV	W	WP	Not connectible
	WL	WL	-	Connectible
	WL	WP	-	Connectible
	WL	W	-	Not connectible
	WL	WP	W	Not connectible

WLV = Indoor Unit Type WL with optional valve kit
 WL = Indoor Unit Type WL without optional valve kit
 WP = Indoor Unit Type WP (without integrated valve and not compatible with the optional valve kit)
 W = Indoor Unit Type W (With integrated valve)



In an HVRF-R2 system, if a valve kit is connected to any of the WL indoor units, all other indoor units must also have a valve.
 The valve kit is required to use the HVRF-Y system.

Heating

Hydronic heat pumps

Hybrid systems

VRF HWS & ATW Heating/Cooling/Domestic hot water 220







ECODAN MULTI - SPLIT - AIR/WATER - AIR/AIR
Heating/Cooling/Domestic hot water 230





Packaged systems

HWHP - CAHV - PACKAGED - AIR/WATER SYSTEM
Heating/Domestic Hot Water 232

HWHP - CRHV - PACKAGED - WATER/WATER SYSTEM
Heating/Domestic Hot Water 238



			Capacity				
			Heating kW	Cooling kW			
					Domestic hot water	Hot water heating	
Hybrid systems							
	PUMY-P		12.5 12.5 12.5	12.5 14.0 15.5	<input checked="" type="checkbox"/>	<input checked="" type="checkbox"/>	
HWS	VRF HWS (Hot Water Supply)		12.5	-	<input checked="" type="checkbox"/>	<input checked="" type="checkbox"/>	
ATW	VRF ATW (Air To Water)		12.5	11.2		<input checked="" type="checkbox"/>	
Packaged systems							
CAHV	HWHP (Hot Water Heat Pump)		40.0	-	<input checked="" type="checkbox"/>	<input checked="" type="checkbox"/>	
CRHV	HWHP (Hot Water Heat Pump)		60.0	-	<input checked="" type="checkbox"/>	<input checked="" type="checkbox"/>	

Supply			Functions		Applications and solutions
				Cascade systems automatic control	
Water cooling	Air heating	Air cooling	Heat recovery		

		•	•			AUTONOMOUS SOLUTIONS <ul style="list-style-type: none"> • Residential (villas, apartments) • Offices • Shops/Bars • SPA/GYMS
		•	•	•		CENTRALIZED SOLUTIONS <ul style="list-style-type: none"> • Residential (villas, apartments) • Offices • Hotel
•	•	•	•	•		INDUSTRY SHOPPING CENTER SPA/GYM

					•	CENTRALIZED SOLUTIONS <ul style="list-style-type: none"> • Residential (condons) • Offices • Hotel
					•	INDUSTRY SHOPPING CENTER SPA/GYM

VRF HWS & ATW

HYBRID SYSTEM - Heating/Cooling/Domestic hot water



CITY MULTI



WATER HEATING



DOMESTIC HOT WATER



ENERGY RECOVERY



AIR COOLING



AIR HEATING

The scalability, flexibility and modularity of the Ecodan® – VRF HWS & ATW system represents the state of the art in Mitsubishi Electric technology. This solution makes it possible to use a single producer – the VRF outdoor unit – to deliver heating water, cooling water and domestic hot water simultaneously.

Hydronic modules for VRF CITY MULTI systems.

Ecodan® heat pump technology has been used in conjunction with hydronic modules to create systems for the production of domestic hot water (HWS) and heating water for radiator panels (ATW) which are perfectly compatible with the inclusion of both thermal and photovoltaic solar panels in the installation. Systems with electric heat pumps may be used all year round, as their use is not restricted by legislation.

The added comfort of being able to use the air conditioning system in spring and autumn is yet another advantage of these VRF systems. The indoor units of the VRF CITY MULTI system gently cool and dehumidify the interior space in spring, cool and dehumidify in summer, transferring the extracted heat to both the HWS and ATW hydronic modules, and heat the interior gently at cooler times of day in autumns.

HWS hydronic modules are ideal for the production of domestic hot water all year round. They make use of the energy drawn from indoor spaces by the VRF indoor units, as well as supplementary energy provided by solar panels in summer and spring.

ATW hydronic modules provide hot water for radiant panel heating in winter and deliver warm water to heat a pool in summer, contributing to maintaining comfortable temperature conditions and making use of the energy drawn from the indoor space by the VRF indoor units supplemented by heat supplied by thermal solar panels.

In systems with this capability, ATW hydronic modules may also be used to deliver refrigerated water to radiant panels in summer.

TYPICAL APPLICATIONS: HOTEL (ROOMS)



TYPICAL APPLICATIONS: CENTRALIZED RESIDENTIAL SYSTEMS



SOLUTION FOR CLIMATIZATION, HEATING AND DOMESTIC HOT WATER PRODUCTION



- 1 R2 Outdoor Units
- 2 Photovoltaic solar panels
- 3 BC controller
- 4 HWS Hydronic Module
- 5 ATW Hydronic Module
- 6 Domestic hot water accumulator tank fed from HWS
- 7 Hot water inertial accumulator tank fed by ATW

— GREEN REFRIGERANT CIRCUIT
 — RED DOMESTIC HOT WATER CIRCUIT
 — ORANGE HEATING HOT WATER CIRCUIT
 — BLACK POWER CIRCUIT

HWS hydronic module – Hot water supply

Mitsubishi Electric was the first to introduce VRF systems for the production of high temperature hot water (up to 70°C), usable for domestic hot water production. The HWS hydronic module represents a significant, innovative technological breakthrough that uses the most advanced refrigeration technology, and has been conceived to be easily integrable with R2/WR2 series VRF CITY MULTI simultaneous cooling / heating systems.

Heat recovery plays a crucial role in these systems, as the HWS hydronic module may be used to extract heat from rooms where cooling is

required, which would otherwise be vented into the outdoor atmosphere, and then use this heat to contribute to hot water production, adding only the supplementary heat necessary to reach the desired temperature. The HWS hydronic module can produce hot water at temperatures up to 70°C in the return line, with a heating capacity of up to 12.5 kW per module which, however, is scalable in relation to internal demand.

HWS HYDRONIC MODULE – HOT WATER SUPPLY

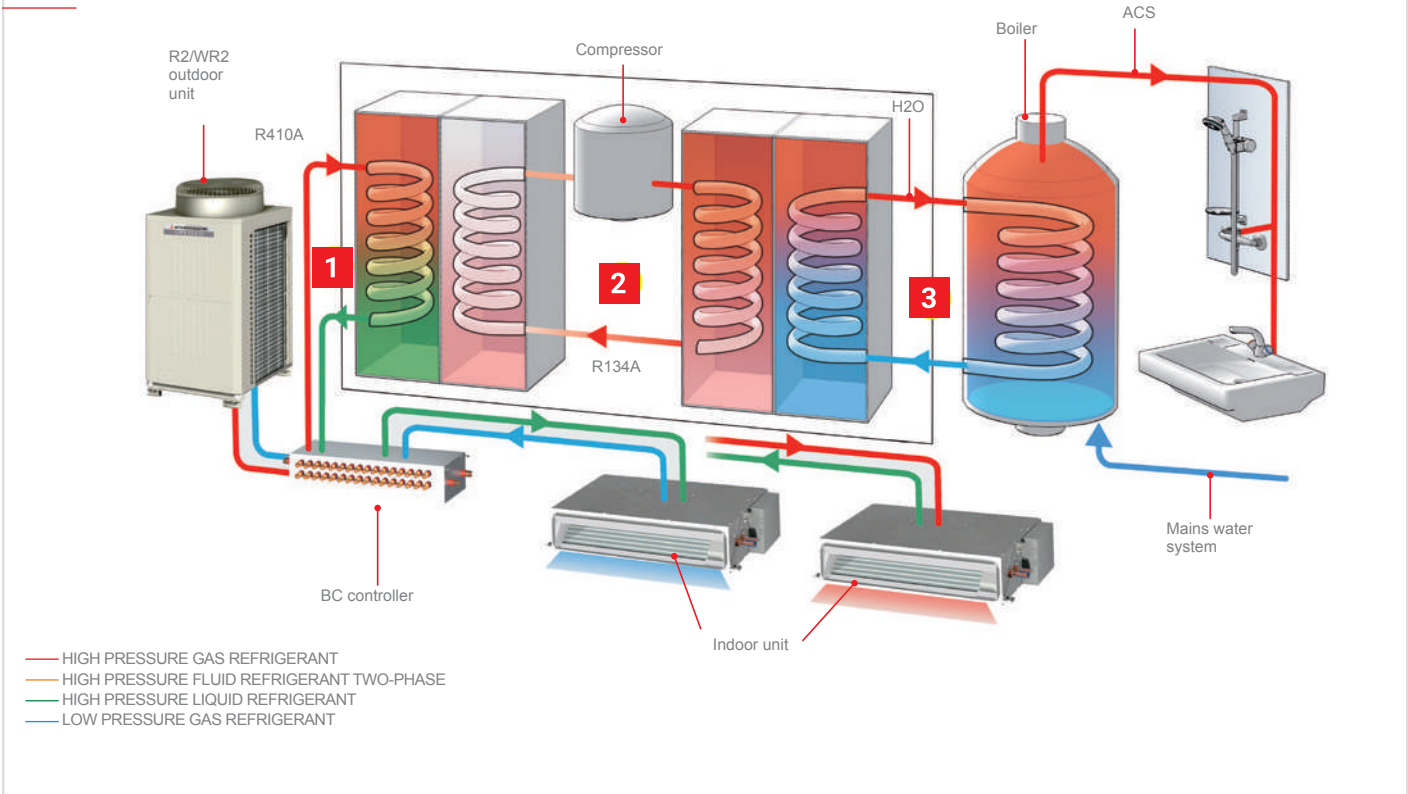

Operating principle of two-stage technology

The HWS hydronic module employs a variant of the two-stage compression principle – a principle that has been known and used for many years, but which, until now, has only been applied in refrigeration systems to reach very low temperatures (as low as -60°C). Mitsubishi Electric has redesigned the two-stage circuit to achieve the opposite effect, for units intended to produce heating power at medium to high temperatures, from 30°C to 70°C. This solution combines superior energy efficiency with high hot water temperatures that are not attainable with the conventional heat pumps currently on the market. As illustrated previously, the HWS hydronic module uses the “free” heat extracted from the air conditioned interior by the heat recovery circuit of the CITY MULTI R2 outdoor units and raises the temperature to the desired value to deliver usable hot water. This double process recovers energy from the system, increasing its overall efficiency, and raises the temperature of the water with minimal energy expenditure.

Advantages of two-stage technology

The two-stage technology employed in the HWS hydronic module offers a number of significant advantages:

- R134a refrigerant in high temperature stage. R134a is a pure HFC refrigerant which is harmless for the stratospheric ozone layer and contributes only marginally to the greenhouse effect. This refrigerant is particularly suitable for high temperature applications.
- R410A refrigerant in low temperature stage. This is also an HFC refrigerant that is harmless to stratospheric ozone, which offers extraordinary efficiency in air conditioning applications.
- Minimal external energy demand, even when the system is operating in air conditioning mode. The heat drawn from the air is used to heat water.
- When the system functions predominantly in air conditioning mode – in summer, for example – hot water is produced with extremely low energy consumption. This makes it possible for the system to attain very high COP values.
- Continuously variable heating power in relation to demand, made possible by the inverter motor scroll compressor, which reduces energy consumption proportionally.
- Compact dimensions and very light weight. These modules may be mounted on walls, even in intermediate positions. Practically zero floor space usage.
- Individual thermal energy consumption billing with field devices.

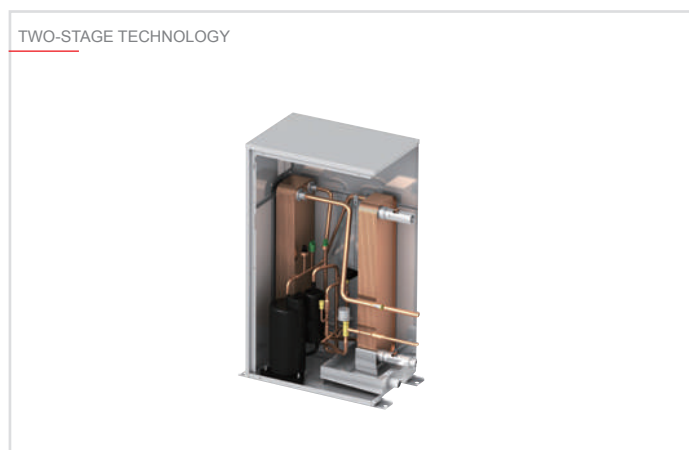

Hybrid systems

The HWS hydronic module may be used to create hybrid systems, with both hydronic modules and VRF direct expansion units. For instance, this makes it possible for the system to produce domestic hot water and heat or cool the air in the indoor space using the most suitable indoor units of the Mitsubishi Electric range (cassette units, ceiling-suspended units, ducted units etc.).

As well as superior energy efficiency, a hybrid system also offers the extraordinary flexibility needed to cater for very diverse situations, which a conventional air conditioner system simply does not.

Control and adjustment system

The HWS hydronic module can be configured for the following operating modes and hot water temperatures:

OPERATING MODE	TEMPERATURE RANGE
Hot water	30 - 70°C
Heating	30 - 50°C
ECO heating	30 - 45°C
Antifreeze	10 - 45°C

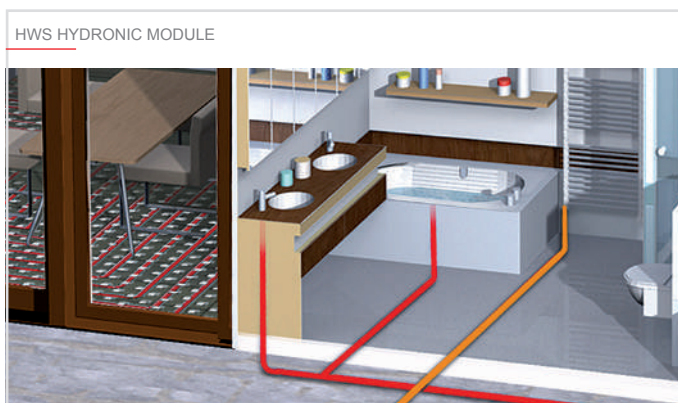



Technical specifications HWS HYDRONIC MODULE

MODEL		PWFY-P100VM-E-BU	
Power			Single-phase, 220-230-240V, 50 Hz/60Hz
Heating power output (nominal)		kW *1	12,5
		kcal/h *1	10,800
		Btu/h *1	42,700
	Power absorption	kW	2,48
	Current consumption	A	11,63 - 11,12 - 10,66
Temp. range in heating mode	PURY Series	Outdoor temp. DB	-20~32°C
	PQRY Series	Water temp. in circuit	10~45°C
	PQRY Series	Temp. in water/glycol circuit (for geothermal applications)	-5~45°C
	PWFY-P VM-E1-BU	Return line water temp.	10~70°C
Connectable outdoor units	Total capacity		50-100% of external unit capacity
	Series		R2 (E)P, WR2
Sound pressure in anechoic chamber	dB <A>		44
Refrigerant circuit piping diameter	Liquid	mm (inches)	ø 9,52 (ø 3/8") brazed
	Gas	mm (inches)	ø 15,88 (ø 5/8") brazed
Water piping diameter	Inlet	mm (inches)	ø 19,05 (R 3/4") screw-on connection
	Delivery	mm (inches)	ø 19,05 (R 3/4") screw-on connection
Drain pipe diameter		mm (inches)	ø 32 (1-1/4")
External finish			Galvanised sheet steel
External dimensions HxLxW		mm	800 (785 without feet) x 450 x 300
Dry weight		kg	60
Compressor	Type		Hermetic scroll compressor with inverter
	Manufacturer		MITSUBISHI ELECTRIC CORPORATION
	Starter method		Inverter
	Power	kW	1
	Lubricant		NEO22
Water in circuit	Nominal	m³/h	0,6 - 2,15
	(entire operating volume)		
Internal circuit protection (R134a)	Overpressure protection		Overpressure sensor, pressure switch calibrated to 3.60 Mpa (601 psi)
	Inverter circuit (COMP)		Overcurrent protection, overheat protection
	Compressor		Outlet temperature protection, overheat protection
Refrigerant	Type / original charge		R134a x1.1kg (0,50lb)
	Controller		LEV
Rated pressure	R410a	MPa	4,15
	R134A	MPa	3,60
	Water	MPa	1
Standard equipment	Manuals		Installation manual, Instruction manuals
	Accessory		Water filter, insulating material

Note:

*Nominal conditions *1 are subject to EN14511-2:2004(E)

*Install the module in an environment with a wet bulb temperature not exceeding 32°C

*Due to continuous improvements made to these products, the specifications given above are subject to modification without prior notification.

*The module is not designed to be installed outdoors.

*1Nominal heating conditions Outdoor temp.: 7°C DB/6°C WB

Nominal heating conditions Outdoor temp.: 7°C DB/6°C WB (45°F DB/43°F WB)

Pipe Length 7.5 m (24-9/16 feet) – Vertical difference: 0 m (0 feet)

ATW hydronic module – Air to water

Mitsubishi Electric has developed the ATW reversible air-water heat pump hydronic module specifically for hydronic heating and air conditioning systems. The refrigeration side of the module may be connected to VRF CITY MULTI SMALL Y and Y Series outdoor heat pump units, or to R2 heat recovery units. The hydronic side of the module may feed heated underfloor systems or other similar utilities, to provide heating in winter in heat pump mode, or cooling in summer in conditioning mode.

Connecting these modules to R2 Series VRF CITY MULTI heat recovery outdoor units offers extraordinarily levels of efficiency, especially in spring and autumn, with extremely high COP values. The HWS hydronic module can produce hot water at temperatures up to 40°C in the return line (45°C in delivery line), with a heating capacity of up to 12.5 kW per module which, however, is scalable in relation to internal demand.

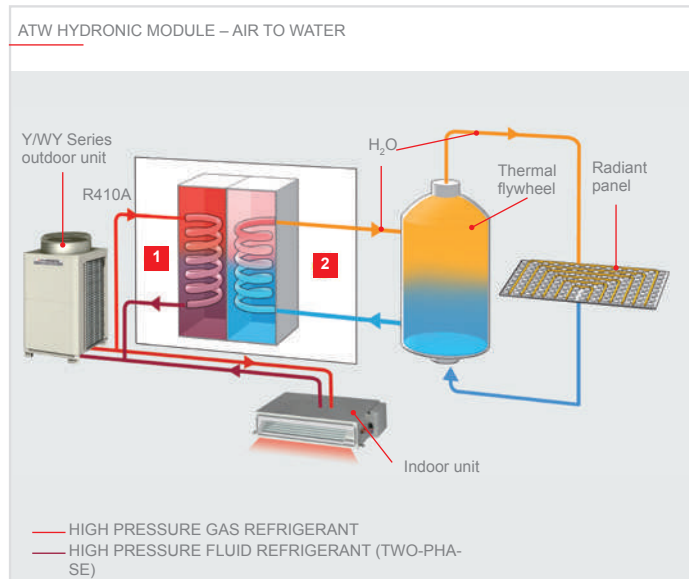

Hybrid systems

Like the HWS module, the ATW hydronic module may be used to create hybrid systems, with both hydronic modules and VRF direct expansion units. For instance, this makes it possible to create a system that can heat certain rooms with radiant panels (a heating solution that is now very popular, as it offers uniform temperatures and quietness) and heat other rooms using appropriate Mitsubishi Electric indoor units (cassette units, wall-mounted units, ducted units etc.). Similarly, conditioning in summer may be performed with a heated underfloor system in rooms where this is installed, and with cooled air in other rooms, via standard VRF indoor units.

This makes it possible to use the most effective treatment solution possible for each interior space, catering for both the requisites of the specific application and the preferences of the user. As well as superior energy efficiency, a hybrid system also offers the extraordinary flexibility needed to cater for very diverse situations, which a conventional conditioning system simply does not.

TYPICAL APPLICATIONS: HOTEL (COMMON AREAS)



TYPICAL APPLICATIONS: CENTRALIZED RESIDENTIAL SYSTEMS (RADIANT PANEL HEATING)



Main features

The functional characteristics of the ATW hydronic module cater for the needs of a very wide variety of different installations:

- nominal heating capacity: 12.5 kW;
- nominal cooling capacity: 11.2 kW;
- outdoor operating temperature range, heating mode: -20°C to +32°C (R2 heat recovery series); -20 to +15.5°C (Y heat pump series);
- outdoor operating temperature range, conditioning mode: -5°C to +46°C (R2 and Y series);
- return hot water temperature range: 10°C to 40°C;
- mains power: single-phase, 230V AC;
- individual thermal energy consumption billing with field devices.

Operating principle

The ATW reversible heat pump hydronic module consists essentially of a brazed plate stainless steel refrigerant-water heat exchanger connected to the VRF CITY MULTI outdoor unit on the refrigeration side, and to the hydronic circuit of the system (radiant panels, radiator units etc.) on the water side. The module is equipped with an electronic expansion valve which modulates the flow of refrigerant in the heat exchanger in response to heating or cooling demand and the demand required by the electronic management and control circuit. The entire system is encased in a housing with compact dimensions and very limited weight comparable to a wall-mounted boiler. The high COP value attained by the ATW hydronic module means that it delivers superior comfort with minimal operating costs, contributing to reducing the CO2 emissions produced for energy production at the power plant. This offers a two-sided advantage as emissions are not only reduced, but also delocalised away from populated areas.

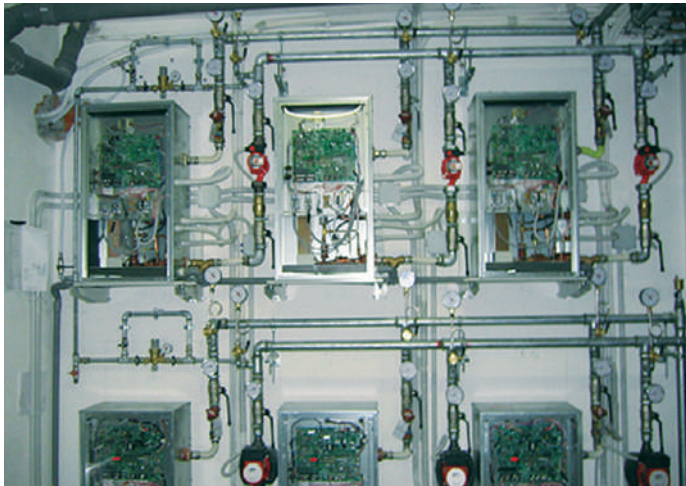

Control and adjustment system

Like the HWS module, the ATW hydronic module is equipped with a sophisticated control system offering a wide choice of functions, selectable in relation to the needs of the installation and the preferences of the user.

The ATW module may be associated with its own independent remote controller (PAR-W21MAA), allowing the user to configure all operating settings, including water temperature, which may be displayed either for the delivery circuit or for the return circuit.

The water temperature reading displayed depends on the type of installation and on the auxiliary controller devices used. The return circuit reading configuration is the most widely used of the two, and allows precise control over the water temperature in the inertial accumulator tank (which is recommended) as a means to balance flows. Once the set temperature is reached, the ATW continues to operate to maintain a constant value.

Note that with this configuration, the delivery temperature is normally higher (max. 45°C) than the set temperature until the set temperature itself is reached.

In installations operating in summer, the ATW produces cold water at a temperature regulated with the same method, based on the primary delivery circuit reading or the return circuit reading.

As the cooling action of the radiant panels only reduces the sensible heat of the interior space, suitable dehumidification systems may also be included in the installation.

The ATW hydronic module can be configured for the following operating modes and hot water temperatures:

MODE	TEMPERATURE RANGE
Heating	30 - 45°C
ECO heating	30 - 45°C
Antifreeze	10 - 45°C
Cooling	10 - 30°C



Technical specifications HWS HYDRONIC MODULE

MODEL		PWFY-EP100VM-E2-AU	
Power			Single-phase, 220-230-240V 50/60Hz
Heating power output (nominal)		kW *1	12,5
		kcal/h *1	10,800
		Btu/h *1	42,700
	Power absorption	kW	0,025
	Current consumption	A	0,138
Temp. range in heating mode	Serie PUMY	Outdoor temp. DB	-
	Serie PUHY	Outdoor temp. DB	-20~15,5°C
	Serie PURY	Outdoor temp. DB	-20~32°C
	Serie PQHY - PQRV	Water temp. in circuit	10~45°C
	Serie PQHY - PQRV	Temp. in water/glycol circuit (for geothermal applications)	-5~45°C
		Return line water temp	10~40°C
Cooling output (nominal)		kW *2	11,2
		kcal/h *2	9,600
		Btu/h *2	38,200
	Power absorption	kW	0,025
	Current consumption	A	0,138
Temp. range in cooling mode	PUMY Series	Outdoor temp. B.S.	-
	PUHY Series	Outdoor temp. B.S.	-5~46°C
	PURY Series	Outdoor temp. B.S.	-5~46°C
	PQHY - PQRV Series	Water temp. in circuit	10~45°C
	PQHY - PQRV Series	Temp. in water/glycol circuit (for geothermal applications)	-5~45°C
		Return line water temp	10~35°C
Connectable outdoor units	Total capacity		50-100% of capacity of OU
	Series		Y (Ecostandard (P), Standard Efficiency (P), High Efficiency (EP)), Zubadan Y, WY, R2 (Standard Efficiency (P), High Efficiency (EP)), WR2
			29 ø 9,52 (ø 3/8") brazed
Sound pressure in anechoic chamber	dB <A>		ø 15,88 (ø 5/8") brazed
Refrigerant circuit piping diameter	Liquid	mm (inches)	ø 19,05 (R 3/4") screw-on connection
	Gas	mm (inches)	ø 19,05 (R 3/4") screw-on connection
Water piping diameter	Inlet	mm (inches)	ø 32 (1-1/4")
	Delivery	mm (inches)	Galvanised sheet steel
Drain pipe diameter		mm (inches)	800 (785 without feet) x 450 x 300
External finish			36
External dimensions HxLxW		mm	1,8-4,30
Dry weight		kg	
Water in circuit	Nominal	m³/h	4,15
	(entire operating volume)		1
Rated pressure	R410A	MPa	Installation manual, Instruction manuals
	Water	MPa	
Standard equipment	Manuals		Water filter, insulating material, 2x external signal connectors, plumbing fittings for filter, flow regulator
	Accessory		

Note:
 *Nominal conditions *1 and *2 are subject to EN14511-2:2004(E)
 *Install the module in an environment with a wet bulb temperature not exceeding 32°C
 *Due to continuous improvements made to these products, the specifications given above are subject to modification without prior notification.
 *The module is not designed to be installed outdoors.

*1Nominal heating conditions
 Outdoor temp.: 7°C DB/6°C WB (45°F DB/43°F WB)
 Pipe length: 7.5 m (24-9/16 feet)
 Vertical difference: 0 m (0 feet)
 Intake water temp.: 30°C
 Water flow rate: 2.15 m³/h (P100)
 4.30 m³/h (P200)

*2Nominal cooling conditions:
 External temp: 35°C DB(95°F DB)
 Pipe length 7.5 m (24-9/16 feet)
 Vertical difference: 0 m (0 feet)
 Intake water temp.: 23°C
 Water flow rate: 1.93 m³/h (P100)
 3.86 m³/h (P200)



SCHEMATIC: ECODAN® VRF HWS & ATW (SIMULTANEOUS HEATING, COOLING AND DOMESTIC HOT WATER PRODUCTION)

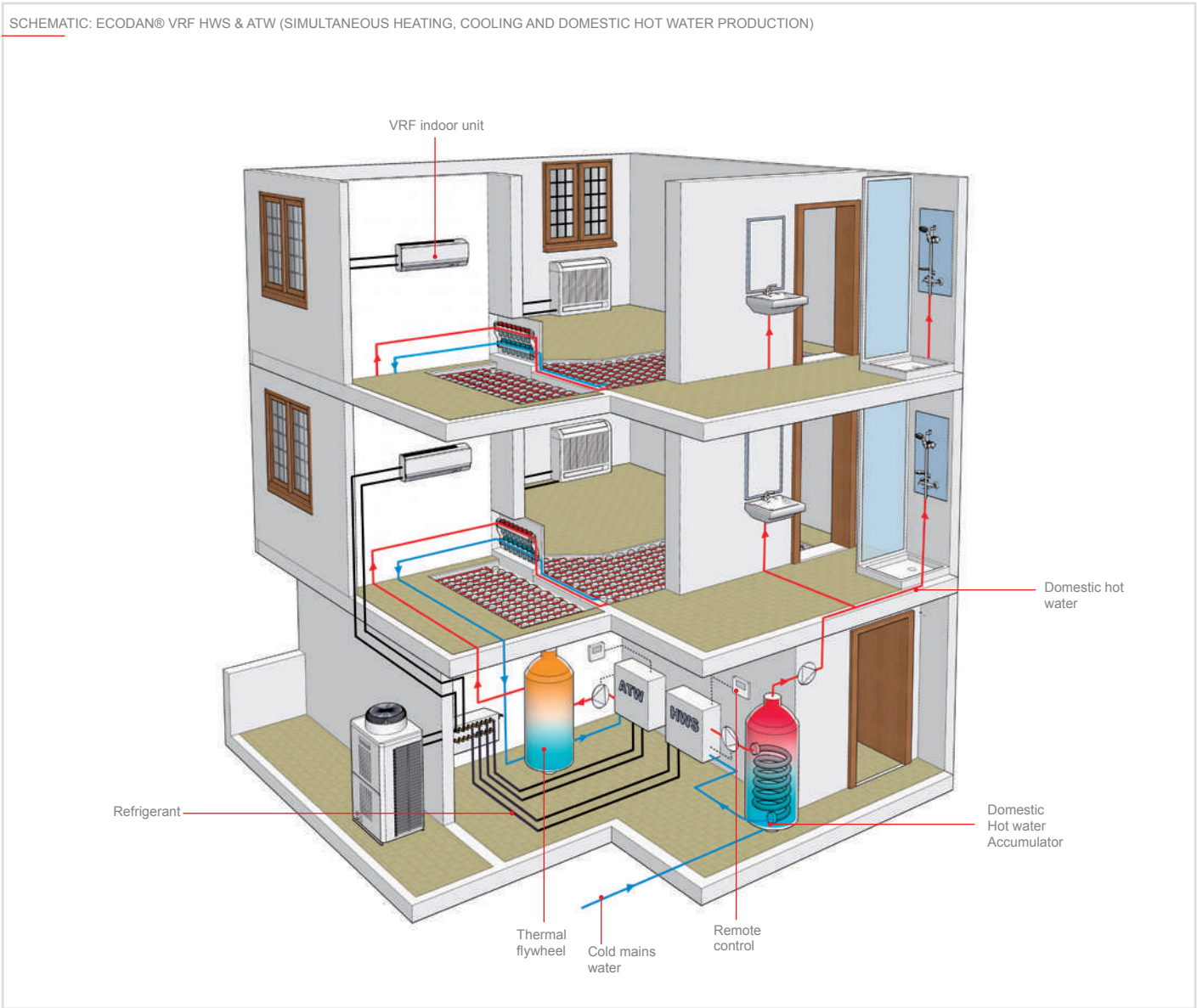

200% EXTENDED CONNECTIVITY FUNCTION



Y SERIES HEAT PUMP UNITS
 With Y Series outdoor units, this function is only applicable in mixed installations and allows the connection of indoor units (air heating or cooling) and an Ecodan@ ATW hydronic module (water heating) with a total capacity index up to 200% of the capacity of the outdoor unit.*

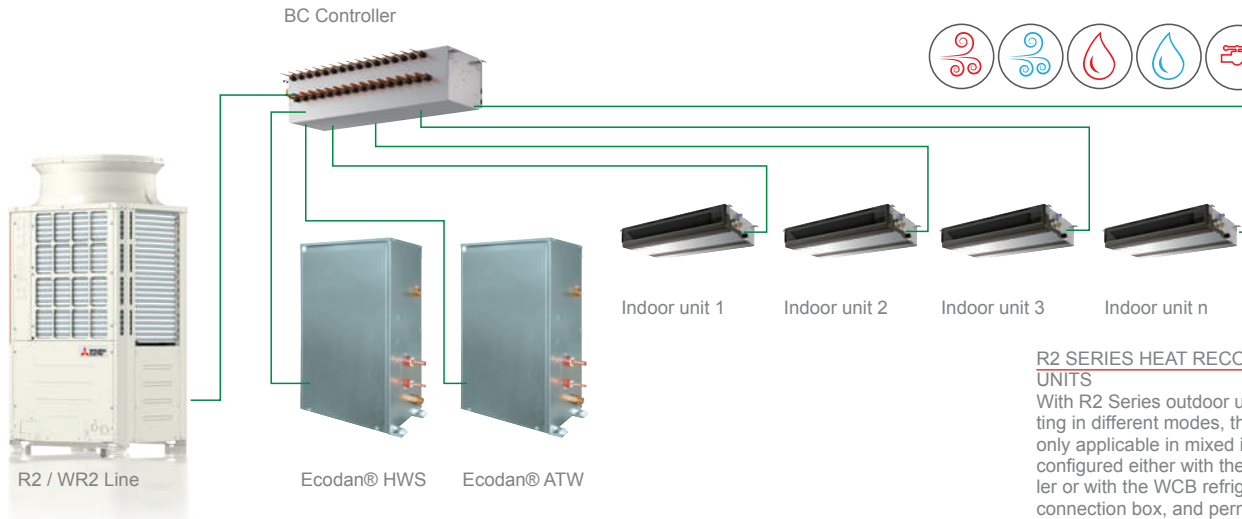

R2 SERIES HEAT RECOVERY UNITS
 With R2 Series outdoor units operating in different modes, the function is only applicable in mixed installations configured either with the BC Controller or with the WCB refrigerant-water connection box, and permits the connection of indoor units (air heating and cooling) and Ecodan@ HWS&ATW hydronic modules (DHW production and water heating) with a total capacity index up to 200% of the capacity of the outdoor unit.*



*For detailed informations, please contact your representative



ECODAN MULTI

SPLIT - AIR/WATER - AIR/AIR - Heating/Cooling/Domestic hot water



WATER HEATING



DOMESTIC HOT WATER



AIR COOLING



AIR HEATING









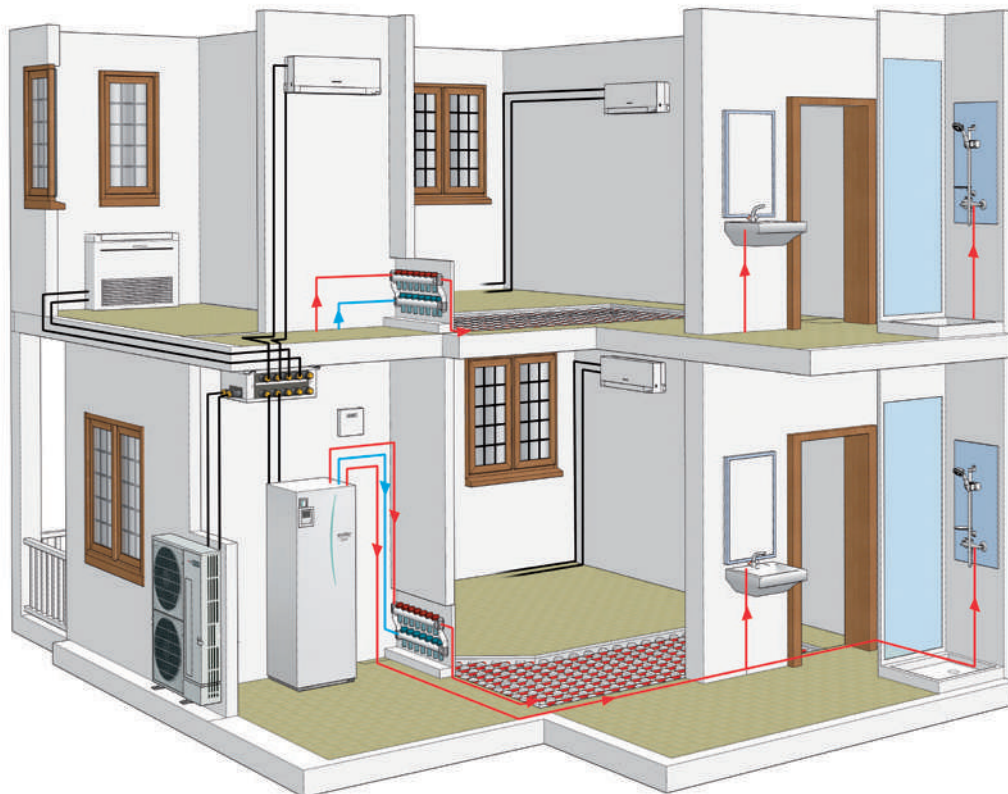



Ecodan® Multi is a hybrid Air/Air, Air/Water system that combines the flexibility of a multisplit system with the

convenience of a hydronic heat pump that can produce hot water for heating and domestic use.

SMALL Y LAYOUT WITH ECODAN

— REFRIGERANT
— WATER



Indoor unit				Outdoor units	
 EHSC	 EHST20C				PAC-MK54BC PAC-MK34BC
HYDROBOX	200-litre HYDROTANK	SERIES M/S/P/CITY MULTI	BRANCH BOX	SMALL Y	
Key Technologies					
					
		* Optional			

Technical specifications HEATING/COOLING/DOMESTIC HOT WATER						
OUTDOOR UNIT				PUMY-P112VKM6 PUMY-P112YKM5	PUMY-P125VKM6 PUMY-P125YKM5	PUMY-P140VKM6 PUMY-P140YKM5
Air/Air	Compatible hydronic modules	Size	MEDIUM			
		Hydrobox	EHSC-VM2D			
		"hot only" model	EHST20C-VM2D			
Air/Air	Power Supply	200-litre hydrotank	EHST20C-VM2D			
		"hot" model only	EHST20C-VM2D			
		Voltage/Freq./Phases	V/Hz/no.	230 / 50 / 1 400 / 50 / 3+N	230 / 50 / 1 400 / 50 / 3+N	230 / 50 / 1 400 / 50 / 3+N
Air/Air	Cooling	Nominal capacity	kW	12,5	14,0	15,5
		Absorbed power	kW	2,79	3,46	4,52
		EER		4,48	4,05	3,43
	Heating	Annual energy consumption	kWh	1395	1730	2260
		Nominal capacity	kW	14,0	16,0	18,0
		Absorbed power	kW	3,04	3,74	4,47
Air / Water Heating ¹	Air 7° / Water 35°	COP		4,61	4,28	4,03
		Nominal capacity	kW	12,5	12,5	12,5
		Absorbed power	kW	3,06	3,06	3,06
	Water temperature	max.		55	55	55
		Low water temperature 35°C (Spring/Autumn)	RANK	A++	A++	A++
		SCOP		4,20	4,20	4,20
	Medium water temperature 55°C (Spring/Autumn)	ηs	%	168	168	168
		RANK		A+	A+	A+
		SCOP		3,02	3,02	3,02
	Production of DHW ²	ηwh	%	121	121	121
		RANK (DHW load profile)		A (L)	A (L)	A (L)
		ηwh	%	106	106	106
Outdoor units	Magnetohermic switch recommended	A	32/16	32/16	32/16	
	Dimensions HxWxD	mm	1338x1050x330(+25)	1338x1050x330(+25)	1338x1050x330(+25)	
	Weight	Kg	122/125	122/125	122/125	
	Sound pressure	dB(A)	49	50	51	
	Sound power max	dB(A)	69	70	71	
	Refrigeration lines	Diameters (gas/liquid)	mm	15,88/9,52	15,88/9,52	15,88/9,52
Length max (min)		m	n.d.	n.d.	n.d.	
Respective height elevation max.		m	n.d.	n.d.	n.d.	
Guaranteed operating range		Air/Air	min/max	-5 / +46	-5 / +46	-5 / +46
Guaranteed operating range	Air/Water	Heating	min/max	-20 / 21	-20 / 21	-20 / 21
		DHW	min/max	-20 / 35	-20 / 35	-20 / 35
		Refrigerant	Type / Preload	Kg	R410A / 4,80	R410A / 4,80
		GWP ³ / Tons CO ₂ Eq.	2088 / 10,02	2088 / 10,02	2088 / 10,02	

¹ In combination with 'hot only' hydronic modules.
² In combination with 200-litre Ecodan Hydrotank.
³ In combination with the hydronic module only.
⁴ Reference notes see last page.

Table of indoor unit combinations

NO. OF CONNECTABLE UNITS	Min/max connectable capacity (kW) x 10	MODEL	Wall Mounted														Floor Standing		1 way cassette		4 way cassette		Ceiling Concealed		Ceiling Suspended																			
			Kirigamine Style							Kirigamine Zen							Plus line																											
			MSZ-LN-VG(2)		MSZ-EF-VG(K)/VE2/3		MSZ-SF VE3		MSZ-AP VG(K)		MSZ-GF VE	MFZ-KJ VE (2)	MFZ-KT VG	MLZ-KP VF	60x60 (Compact)		90x90 (Standard)		Low static pressure		Middle static pressure		PCA-M KA																					
			25	35	50	18	22	25	35	42	50	15	20	25	35	42	50	60	71	25	35	50	25	35	50	25	35	50	35	50	60	71	100	25	35	50	60	71	50	60	71	100	35	50
8	30/162	PUMY-P112																																										
	30/182	PUMY-P125																																										
	30/202	PUMY-P140																																										

* [kW]x10, COMPATIBILITY TABLE FOR MODELS PUMY P VKM5; PUMY P112-140 Y(V) KM4 R(2);
¹ ONLY MSZ-SF 15/20 VA
² ONLY MSZ-AP 15/20 VF
ONLY for R2 model : MSZ-LN VG2 ; MSZ-EF-VGK, MSZ-AP-VGK; MFZ -KT VG

HWHP - CAHV NEW

PACKAGED - AIR/WATER SYSTEM - Heating/Domestic Hot Water



WATER HEATING



DOMESTIC HOT WATER

Low-GWP refrigerant R454C

In Europe, the F-gas Regulation is implemented to prevent global warming and unwanted climate changes. The current target is to reduce the total amount of F-gases (CO₂ equivalent) by about 80% across Europe by 2030 compared to 2015. Mitsubishi Electric offers more environmentally friendly hot water heat pumps that use the low Global Warming Potential (GWP) refrigerant R454C.

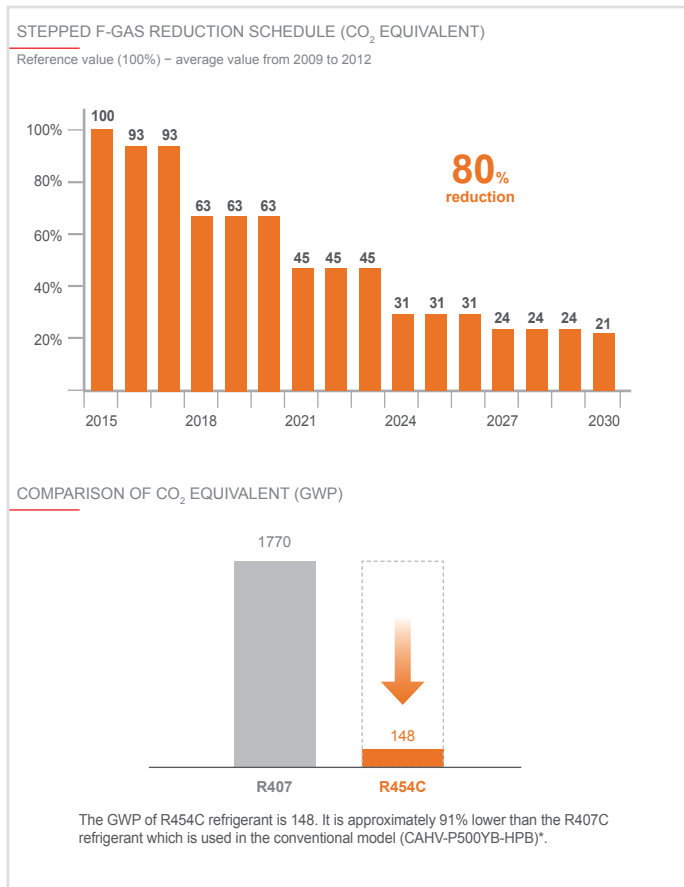

Extention of low operating temperature range

Hot water heat pumps absorb energy from the surrounding outdoor air and transfer it into refrigerant. Heat energy absorbed from air heats up the incoming water via the heat exchanger. The Seasonal Coefficient of Performance (SCOP) of the new CAHV is 3.57 (low temperature conditions) / 3.24 (medium temperature conditions)*, which means it can extract more than three times the input electric energy.

*Above values are based on Regulation (EU) No.811/2013.

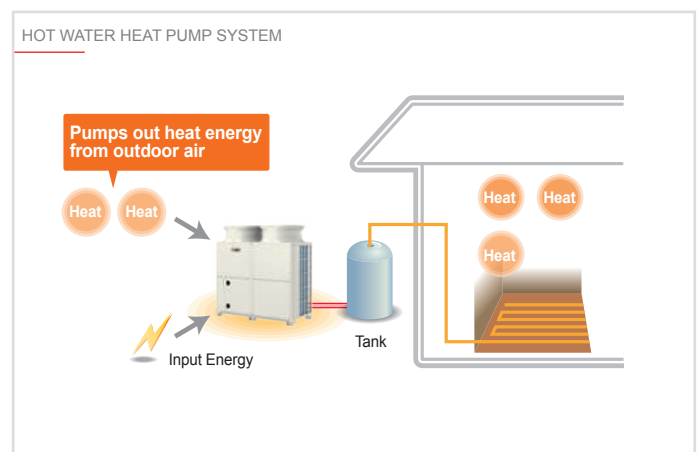

The lower outdoor temperature limit for 70°C hot water output has been extended from -10°C in the conventional model to -20°C in the new model. The operating temperature range has also been improved from "-20°C to 40°C" to "-25°C to 43°C". It is suitable for heating and heat-retention operations.

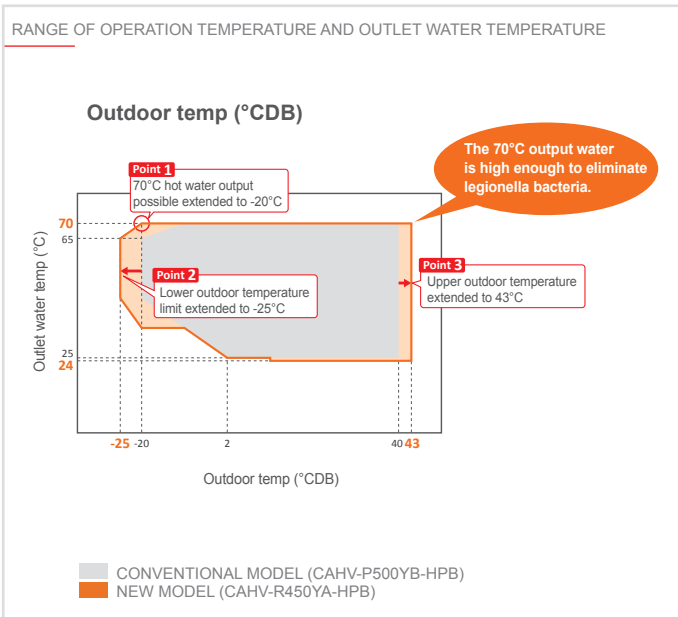

Low maintenance & design flexibility

Clean and safe

The hot water heat pump system runs on electricity only. It does not require the safety measures and periodic inspections required for gas and other combustion appliance-mounted systems, and does not generate toxic substance such as NOx.

Rotation function

When two or more units are in the system, the unit runs alternately, ensuring an optimum product lifecycle for both component units.

Multi-unit installation

The number of outdoor units can be adjusted from 1 to 16 according to the tank storage capacity.

Wide variety of external input / output

Various system configurations are available:

- Two external output for backup heater
- Analog input to control capacity
- Defrost signal

*Refer to the Data Book for other functions.

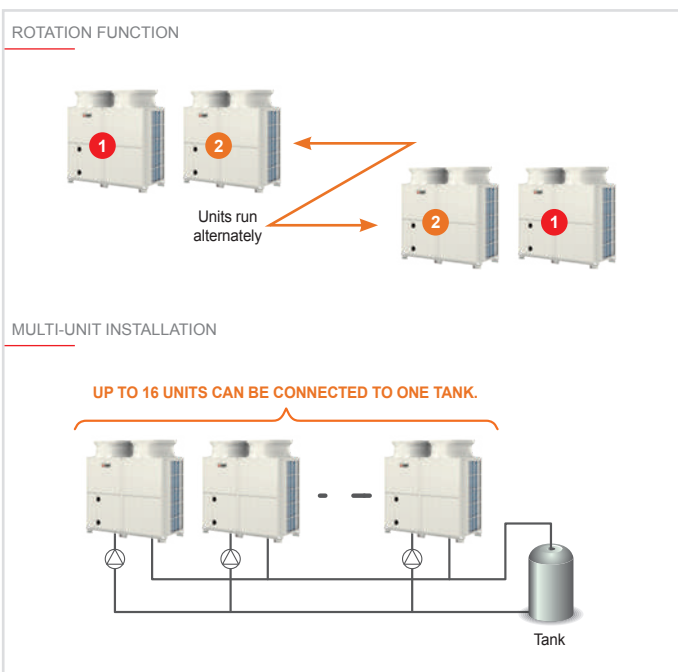

Refrigerant circulation and pressure control with two LEVs

The R454C refrigerant is a lower pressure refrigerant than R407C, which is used in the conventional model, and R410A, which is commonly used in air conditioners. Because low-pressure refrigerants have a low refrigerant density, securing circulation volume can be challenging especially when the refrigerant circuit pressure drops due to low outdoor temperatures or other conditions.

Linear expansion valves (LEVs) before heat exchanger (HEX) were increased from one to two and placed in parallel. The opening of LEV1, which focuses on securing the refrigerant circulation volume, and LEV3, which focuses on controlling the refrigerant pressure, are controlled respectively to control the refrigerant circulation.

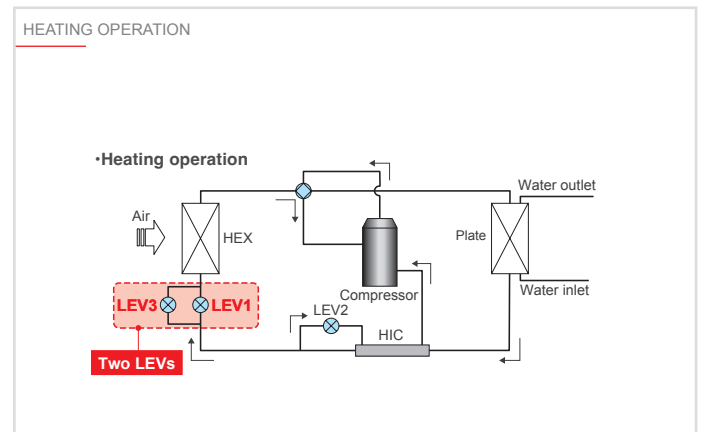



New spiral structure

The low density of R454C refrigerant requires an increased amount of refrigerant to be discharged from the discharge section. The new compressor uses a new material for the fixed spiral section, which enables the tooth to be thinner while maintaining their strength. The height of the teeth has also been lengthened. This synergistic effect has resulted in a 15% increase in the extrusion volume from the discharge section compared to the conventional model (assuming the scroll section of the old and new compressors has the same volume).

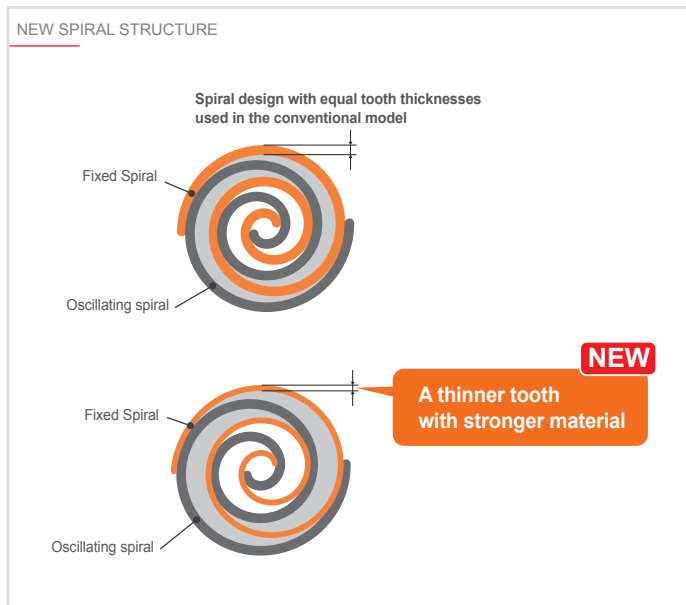

Flash injection circuit

The flash injection circuit is a Mitsubishi Electric technology used in air conditioner for cold climates. The CAHV also adopts this circuit to help units produce high-temperature water even at low outdoor temperatures.

Liquid refrigerant, whose pressure is reduced by the LEV2, exchanges heat in the HIC circuit and becomes gas-liquid two-phase refrigerant. This two-phase refrigerant flows into the injection port in the compressor for controlling the increase of the discharge temperature. Therefore the optimal amount of refrigerant can be provided to the system via the compressor.

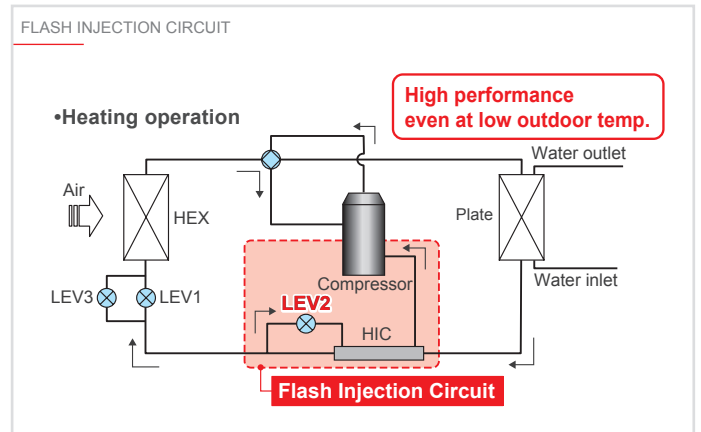

Expanded inverter frequency control lower limit

The new compressor has an expanded lower limit of the frequency control range compared to the conventional model. This expanded lower-limit control helps minimize thermo ON/OFF frequency during low-load operations, such as in intermediate seasons, and improves energy efficiency.

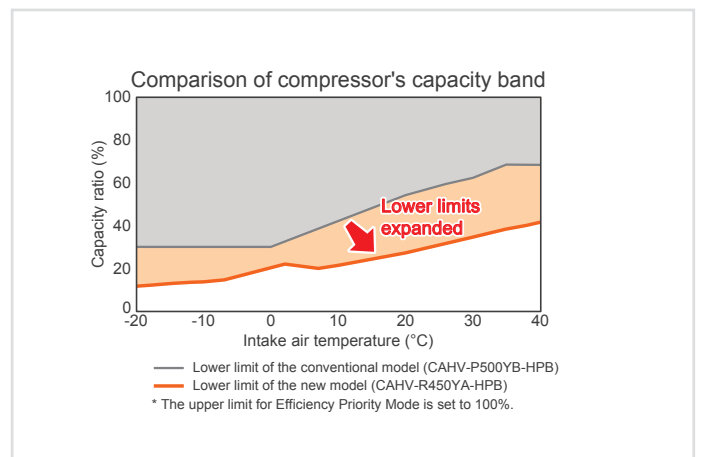

PAR-W31MAA - Individual remote controller

PAR-W31MAA offers an easy-to-see full-dot and backlit LCD display. Basic operations, such as ON/OFF, mode switching, water temperature setting and schedule setting, can be performed. Up to 16 units can be controlled with one remote controller.



MAJOR FUNCTIONS	
Operation/ setting	ON/OFF
	Hot water/Heating/HeatingECO/Anti-freeze
	Snow/regular
	Demand
	Scheduled operation (daily/weekly)
Display	Operation mode
	Current water temperature
	Error code

AE-200E / AE-50E / EW-50E Centralized remote controller

The CAHV-R450YA-HPB(-BS) is connectable to the AE-200E that centrally controls up to 50 units or 50 systems connected via M-NET.

OPTIONAL PART	
Description	Model
Representative water temperature sensor	TW-TH16-E

MAJOR FUNCTIONS	
Operation/ setting	ON/OFF
	Hot water/Heating/HeatingECO/Anti-freeze
	Snow/regular
	Scheduled operation (daily/weekly)
Display	Operation mode
	Current water temperature
	Error code

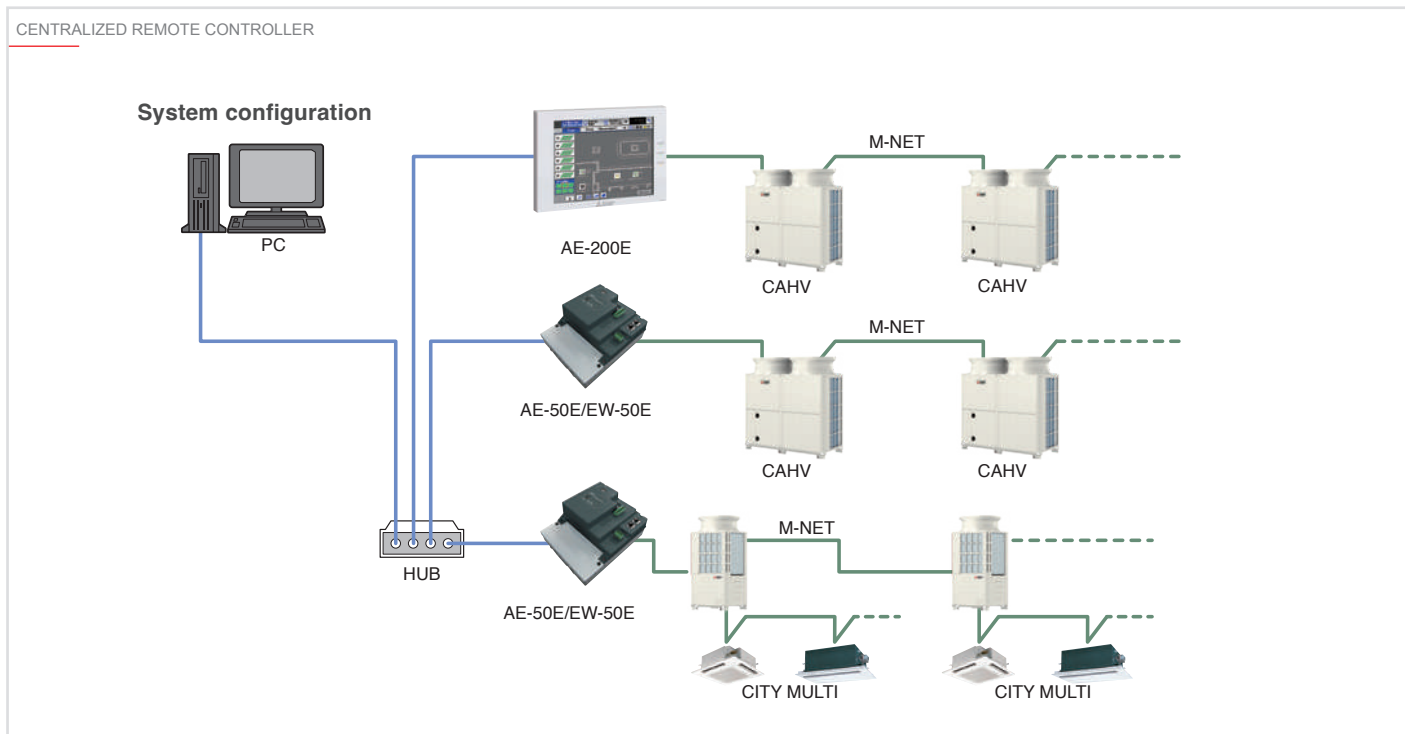

MODEL			CAHV-R450YA-HPB (-BS)
Power source			3-phase 4-wire 380-400-415V 50/60Hz
Capacity (EN14511) *1		kW	40.0
		kcal/h	34,400
		BTU/h	136,480
	Power input	kW	14.03
	Current input	A	23.7-22.5-21.7
	COP	kW/kW	2.85
	SCOP Low/Medium		3.57/3.24
Capacity (EN14511) *2		kW	35.0
		kcal/h	30,100
		BTU/h	119,420
	Power input	kW	20.13
	Current input	A	34.0-32.3-31.1
	COP	kW/kW	1.74
Maximum current input		A	44.0-41.8-40.3
Water pressure drop *1			10.2kPa (1.47 psi)
Temperature range *5	Outlet water temperature		24-70°C 75.2-158°F
	Outdoor temperature	D.B.	-25-43°C -13-109.4°F
Circulating water volume range *6			1.5m³/h-15.0m³/h
Sound pressure level (measured 1 m below the unit in an anechoic room) *1 *4		dB (A)	64
Sound pressure level (measured 1 m below the unit in an anechoic room) *3 *4		dB (A)	72
Water pipe diameter and type	Inlet	mm (in)	38.1(Rc1 1/2"),housing type joint
	Outlet	mm (in)	38.1(Rc1 1/2"),housing type joint
External finish			Acrylic painted steel sheet <Munsell 5Y 8/1 or similar>
External dimensions H × W × D		mm	1710 x 1750 x 740
Net weight		kg (lb)	359 (791)
Design pressure	R454C	MPa	3.85
	Water	MPa	1.0
Drawing number	Wiring		KW94C870
	External appearance		KW94C397
Heat exchanger	Water-side		Copper brazed stainless steel sheet
	Air-side		Plate fins and copper tubes
Compressor	Type		Inverter scroll hermetic compressor
	Manufacturer		mitsubishi electric corporation
	Starting method		Inverter
	Motor output	kW	12.1
	Lubricant		FVC32EA
Fan	Air flow rate m³/min	m³/min	150 × 2
		L/s	2500 × 2
		cfm	5297 × 2
	External static pressure		10 Pa (1 mm H2O)
	Type and quantity		Propeller fan x 2
	Control and driving mechanism		Inverter control, direct driven by motor
Motor output kW	kW		0.92 x 2
HIC (Heat inter-changer) circuit			Copper pipe
Protection devices	High pressure		High-pressure sensor and switch set at 3.85 MPa (643 psi)
	Inverter circuit		Overheat and overcurrent protection
	Compressor		Overheat protection
	Fan motor		Thermal switch
Defrosting method			Auto-defrost mode (Reversed refrigerant cycle)
Refrigerant	Type and factory charge	kg	R454C, 9.0 kg
	Flow and temperature control		LEV and HIC circuit

Note:
 *1 Under normal heating conditions at the outdoor temperature of 7°CDB/6°CWB (44.6°FDB/42.8°FWB), the outlet water temperature of 45°C (113°F), and the inlet water temperature of 40°C (104°F)
 *2 Under normal heating conditions at the outdoor temperature of 7°CDB/6°CWB (44.6°FDB/42.8°FWB) and the outlet water temperature of 70°C (158°F)
 *3 Under normal heating conditions at the outdoor temperature of 7°CDB/6°CWB (44.6°FDB/42.8°FWB) when the unit is set to the "Capacity Priority" mode through the dry NC-contact
 *4 The sound pressure level is a value measured in an anechoic room in accordance with the conventional method in JRA 4060.

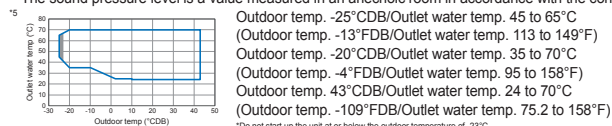

*5 4.0-15.0m³/h under the following conditions.
 a. When the outdoor temperature is below 0°C.
 b. When the outlet water temperature is 30°C or below AND the outdoor temperature is 6°C or below.

Fluorinated Greenhouse Gases Information

Model Name	Refrigerant		Model	
	type	GWP	Weight [kg]	CO ₂ equivalent [t]*
CAHV-R450YA-HPB (-BS)	R454C	148	9.0	1332



HWHP - CRHV

PACKAGED - WATER/WATER SYSTEM - Heating/Domestic Hot Water



WATER HEATING



DOMESTIC HOT WATER

The Ecodan® - Packaged HWHP (Hot Water Heat Pump) system consists of an outdoor monoblock air condensing unit which produces very high volumes of high-temperature hot water.

Packaged WtW heat pumps for hot water

With the latest Hot Water Heat Pump Packaged Water to Water CRHV system, Mitsubishi Electric has added to its range of heat pumps for hot water production and established the company as a leader in the manufacture of these systems. The CRHV packaged system is equipped with two compressors using R410A refrigerant, delivering a nominal capacity up to 60kW and drawing energy from the ground. It is the ideal solution for geothermal applications and applications using groundwater, river or lake water as a heat source to produce hot water for heating or domestic use up to 65°C. The Hot Water Heat Pump CRHV system offers class-beating innovation and efficiency.

Technology

SCOP
Over 4*

The new CRHV packaged system is also equipped with a flash-injection circuit designed for the VRF CITY MULTI ZUBADAN Y system (heat pump system for very cold climates). By using this advanced injection system and a highly efficient compressor, the CRHV packaged system can deliver

high-temperature hot water up to 65°C, and ensures fewer losses in terms of performance and capacity at very low outdoor temperatures.

* SCOP 4.33 - Outlet water/glycol temperature -3°C. Outlet water temperature 35°C.

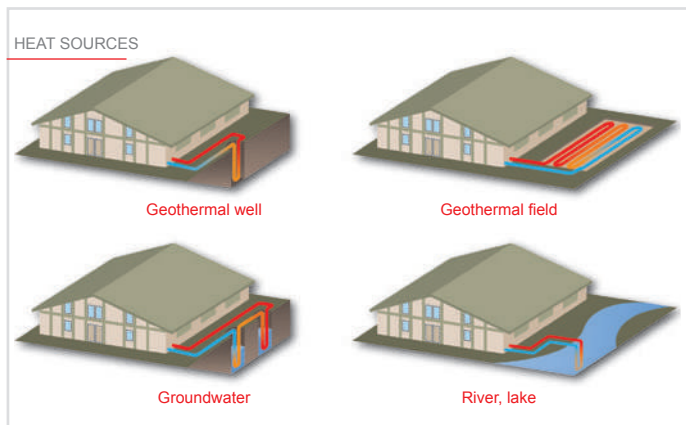
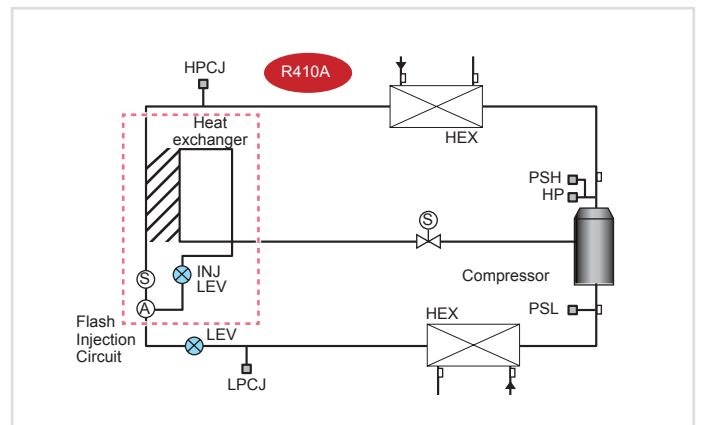

Upgrading existing systems

The latest CRHV packaged system can reuse existing geothermal probes or wells, adapting to their actual thermal capacity. The inverter-driven CRHV packaged system is capable of adjusting its thermal capacity to between 45kW and 60kW in relation to the actual amount of heat deliverable by the existing geothermal well.

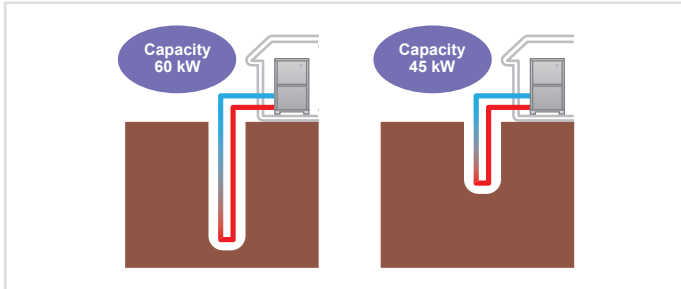

Operating temperatures

The new CRHV packaged system is capable of operating at incoming source water temperatures of between -8°C and 27°C with a counterflow configuration (the incoming source water temperature range can be extended up to 45°C using a parallel flow configuration). The water delivery temperature range is from 30°C to 65°C (in parallel flow configuration, the maximum water delivery temperature is 60°C at incoming water temperatures above 27°C). The CRHV packaged system is suited to indoor installation.

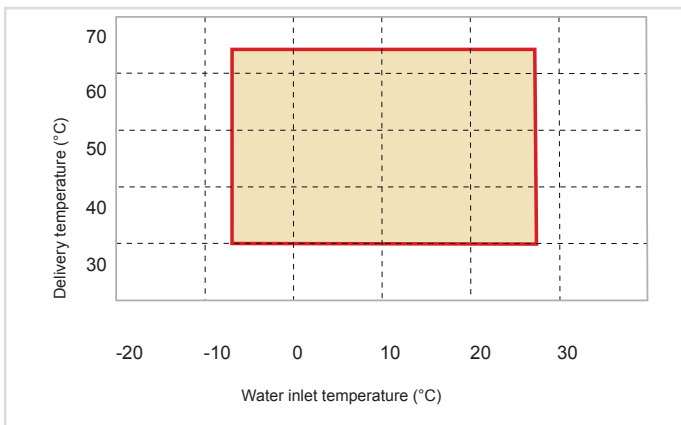

Finishing treatment

The module can also be ordered with a special protective finish on request, for installation in particularly harsh or corrosive environments.



Backup and rotation functions

Backup Function
Rotation Function

The CRHV packaged system is highly reliable thanks to its Backup function, which ensures that if one of the compressors in an individual system fails, the other will continue operating to avoid the inconvenience of the system shutting down completely. Obviously heat capacity is halved under these conditions.

Another key function for ensuring uniform operation and optimal compressor lifetime in compressors in CRHV packaged systems in multiple configurations is the Rotation function. This ensures that when an installation has two or more systems, the individual systems will operate in turn if thermal demand does not require simultaneous operation.

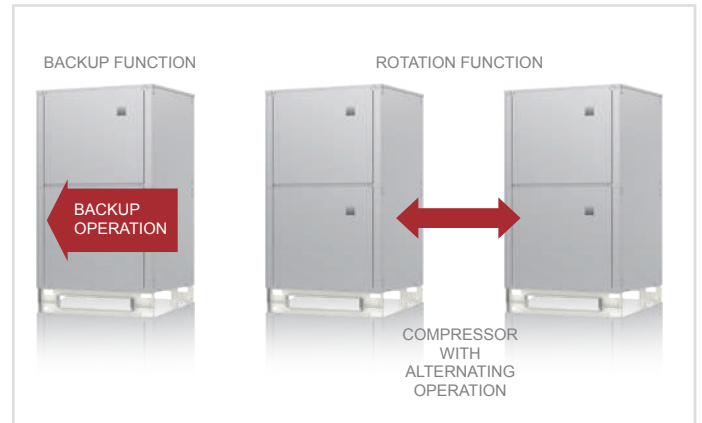

Cascade systems

When the demand for large volumes of hot water production is high, a flexible, modular thermal power installation can be created with up to 16 CRHV packaged systems, for a maximum output of up to 960 kW, with integrated cascade control.

This solution offers a high level of modularity thanks to the 2 DC scroll inverter compressors installed in an individual system, ensuring that thermal power is adjusted progressively and with extreme precision in relation to actual hot water demands. This optimises the operation of the entire installation, with only part of the CRHV packaged system operating under medium-load conditions during typical spring and autumn temperatures.

A malfunction in one or several CRHV packaged systems will not compromise the operation of the other systems in the installation, ensuring safety and continuous operation.



External remote control

Wide variety of external input/output

A wide choice of analogue and digital inputs and digital outputs available with the system's electronics enables remote control operation (via a BMS, timer or external contacts). The following are just some of the available input signals:

- Option of selecting operating mode and hot water production temperature setpoint, choosing Heating Mode or ECO Heating Mode. The latter mode is particularly advanced, as it uses the outdoor air compensation curve to automatically determine the water delivery setpoint.
- Option of selecting operating mode and hot water production temperature setpoint, choosing Domestic Hot Water Mode or Heating Mode. This makes it possible to configure two different water temperature setpoints, a higher value for domestic hot water production and a lower value for heating. This improves performance at partial loads, as DHW is only produced when required.
- Selecting Efficiency Mode (COP) or Capacity Mode for unit operation. This means system operation can be optimised in relation to demand, increasing power or performance depending on requirements.
- Selecting ON/OFF on the basis of the signals received from the flow regulator switch and the circulation pump, for increased protection of the hydronic circuit and satisfactory system operation.

The following are just some of the available output signals:

- A digital output can be enabled at a selectable minimum water temperature to start an alternative heat generator (boiler, solar panel etc.) to substitute the system if it is OFF.
- 3-way valve control in relation to hot water or heating demands.
- Pump control on circuit hot water side and heat source side (ON/OFF).

The result is maximum control flexibility, either locally using the dedicated PAR-W21MAA remote controller, or remotely using external contacts.

Compact dimensions

The unit has a compact footprint thanks to the latest, highly-efficient heat exchanger with low pressure losses. Installation footprint 0.73 m²*

*Dimensions of a unit excluding service space.

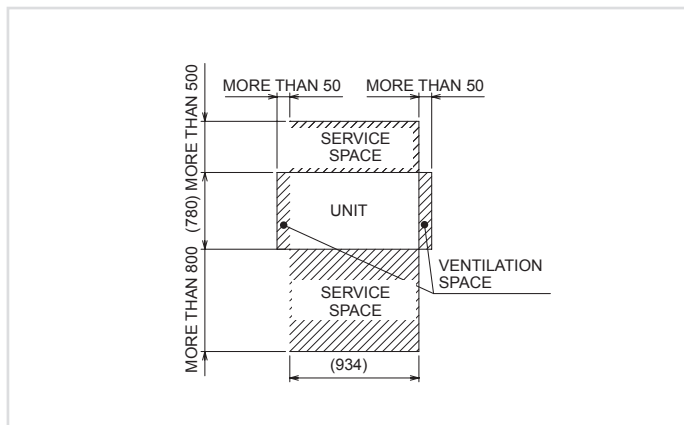

Control and monitoring functionality with centralized WEB Server controllers

With the M-Net data transmission bus, the CRHV packaged system can interface with the centralised **WEB Server 3D Touch** and **3D Blind Controllers** of the VRF CITY MULTI control system range. Depending on the application, the CRHV packaged system can therefore interface with a VRF CITY MULTI system to optimise operation when catering for hot water, heating and air conditioning demands, or to manage, monitor and supervise the system in a standalone configuration for applications solely requiring the production of large volumes of hot water. In both cases, the system can be controlled via a 10.4" backlit, colour touchscreen display on the 3DT controller, or via the Internet using the web pages for either centralised controller.



LAYOUT: ECODAN® PACKAGED HWHP CRHV (LOW AND HIGH TEMPERATURE HEATING + DHW)

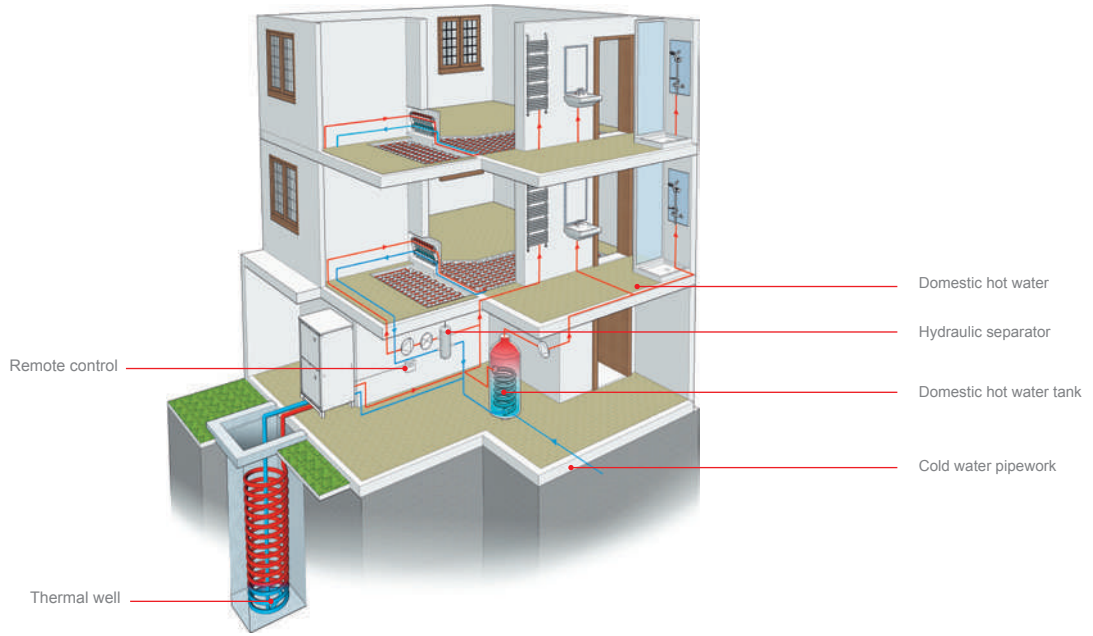

Technical specifications HEATING/COOLING/DOMESTIC HOT WATER

MODEL				CRHV-P600YA-HPB
Spring/Autumn heating	Power Supply	Voltage/Freq./Phases	V/Hz/no.	3 phases 380-400-415V; 50/60 Hz
	SCOP (power 60 kW) EN14825 Avg. clim. cond.	Heat source water/glycol 0°C/-3°C, Hot water 30°C/35°C		4,33
		Heat source water/glycol 0°C/-3°C, Hot water 47°C/55°C		2,89
	Nominal heating capacity ¹	Absorbed power	kW	60
		Absorbed current	A	24,0 - 22,8 - 22,0
		COP		4,23
		Flow rate of water in circuit	m³/h	10,3
		Flow rate of heat source water/glycol	m³/h	14,7
	Nominal heating capacity ²	Absorbed power	kW	45
		Absorbed current	A	17,2 / 16,4 / 15,8
		COP		4,41
		Flow rate of hot water in circuit	m³/h	7,7
		Flow rate of heat source water/glycol	m³/h	11,2
	Heat source liquid			Ethylene Glycol 35 WT
	Temperature range ⁴	Hot water side	°C	30 - 65
		Heat source water/glycol side	°C	-8 - 27
	Low water temperature 35°	Rank		A++
		ηS	%	153
	Medium water temperature 55°	Rank		A++
		ηS	%	127
Water pressure drop	Hot water side ³	kPa	14	
	Heat source water/glycol side ³		38	
Water pipe diameters	Return	mm	50,8 (Rc 2") threaded	
	Delivery	mm	50,8 (Rc 2") threaded	
Flow rate of water in circuit	Hot water side	m³/h	3,2 - 15,0	
	Heat source water/glycol side	m³/h	4,5 - 16,0	
Sound level at 1 m		dBA	50	
External dimensions HxWxD	HxWxD	mm	1561 x 934 x 780	
Net weight		kg	395	
Ref. refill R410A/CO ₂ Eq		kg/Tons	9/18.79	

Note:
¹ Nominal heating conditions: hot water delivery temperature 35°C; water/glycol outlet temperature -3°C; hot water return temperature 30°C; water/glycol inlet temperature 0°C.
² Includes the power absorbed by the pump in accordance with EN14511
³ Nominal heating conditions: hot water delivery temperature 35°C; water/glycol outlet temperature -3°C; hot water return temperature 30°C; water/glycol inlet temperature 0°C. Power 60 kW, hot water flow rate 10.3 m³; water/glycol flow rate 14.7 m³
⁴ GWP of HFC R410A equivalent to 2088 in line with regulation 517 / 2014.

Ventilation

All fresh air (AFA)

PEFY-P VMHS-E-F Outdoor fresh air intake unit (afa) 246

Lossnay enthalpy heat recovery (LGH)

LGH-RVS - Ducted sensible heat recovery unit 248

LGH-RVX3 Lossnay - Heat recovery ventilation unit **NEW** 252

LGH-RVXT Lossnay - Heat recovery ventilation unit 258

Outdoor air treatment indoor units

GUF-RD(H)4 Monoblock indoor unit with fresh air intake fan 260

s-AIRME Outdoor air handling units **NEW** 260



TYPE	MODEL NAME	MODEL
All fresh air (AFA)	PEFY-P125VMHS-E-F PEFY-P200VMHS-E-F PEFY-P250VMHS-E-F	
Lossnay Enthalpy heat recovery (LGH)	LGH-RVS-E	
	LGH-RVX3-E	
	LGH-150RVXT-E LGH-200RVXT-E LGH-250RVXT-E	
Outdoor air treatment indoor units (GUF)	GUF-50RD(H)4 GUF-100RD(H)4	
	s-AIRME	

Air flow (mc/h)							
500	600	800	1000	1600	2000	2500	
			•	•	•		
•		•	•				
					•	•	•
•			•				

PEFY-P VMHS-E-F

OUTDOOR FRESH AIR INTAKE UNIT (AFA)



Ideal for...

...feeding temperature-controlled fresh outdoor air into building. The ideal solution for offices, large stores and restaurants.

Enables intake of outside air

The indoor purified air delivery unit may be installed anywhere. The purified air delivery unit may be used to feed fresh, purified outdoor air into any building, in any place and at any time.

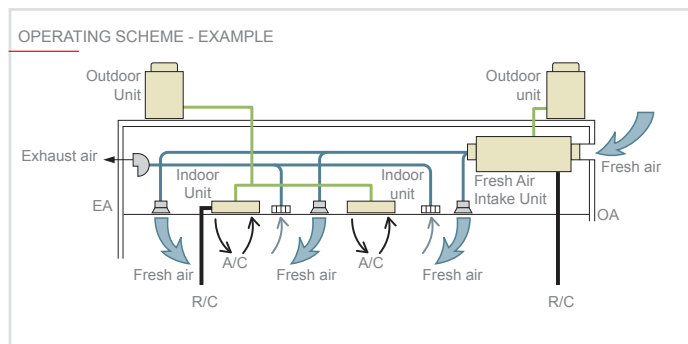
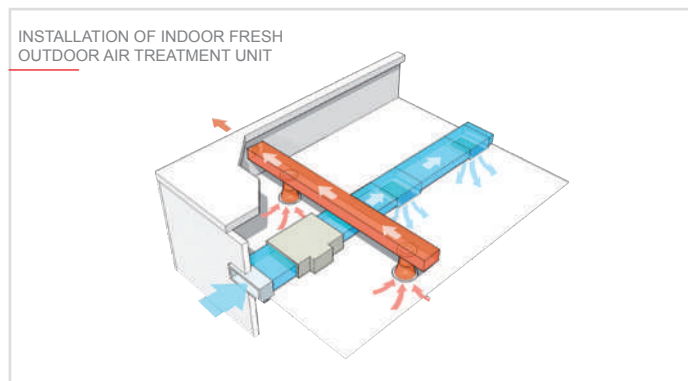

Controllable outlet air temperature

With new PEFY-P VMHS-E-F is possible to operate **Supply Air** temperature control.

OPERATION MODE	TEMPERATURE RANGE SETTABLE
COOL mode	14°C - 30°C
HEAT mode	17°C - 28°C
AUTO mode (single set point)	17°C - 28°C
FAN	Not settable

*In some cases the temperature of the air introduced into the ambient may be subject to fluctuations due to the conditions of the external air and to the operating conditions of the system.

Equipped with new DC fan motor

Fan motor has been changed to higher efficiency DC motor. Power source has been changed from three-phase power supply to **single-phase** power supply for all sizes.

Maximum connectable indoor units capacity to outdoor unit

Max. 110% of outdoor unit capacity (100% in case of heating below -5°C).

Flexible air-flow setting

4 levels of external static pressure to choose. External static pressure can be set also by remote controller (PAR-33/40MAA, PAR-U02MEDA and PAR-CT01MA).

MODEL	P125	P200	P250
External Static Pressure (Pa)	<100>-<150>-200-<250>		

*The factory setting of external static pressure is shown without chevrons "<>".

Two types of air-flow modes are available, each of which has three air-flow rates to choose from:

- Normal Airflow rate
- High Airflow rate

Air-flow rates are accessible from the remote controller (PAR-33/40MAA, PAR-U02MEDA and PAR-CT01MA).

Mode	Normal-airflow rate	High-airflow rate
Air-flow rate	Low-Medium-High	Low-Medium-High

Drain pump (optional)

Greater design flexibility made possible by the increased head height (700 mm max).

UNIT MODEL	DRAIN PUMP MODEL
PEFY-P125 VMHS-E-F	PAC-DRP10DP-E2
PEFY-P200 VMHS-E-F	PAC-KE06DM-F
PEFY-P250 VMHS-E-F	PAC-KE06DM-F

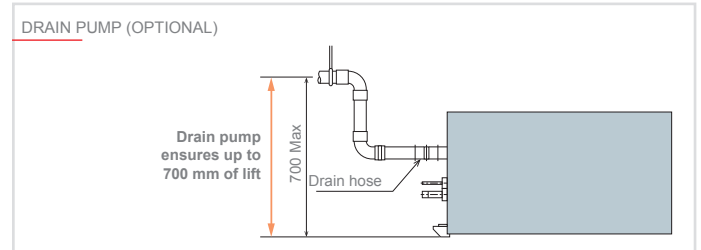

Specifications

MODEL		PEFY-P125VMHS-E-F	PEFY-P200VMHS-E-F	PEFY-P250VMHS-E-F			
Power source	V/phase/Hz	1 phase, 220-230-240V 50/60 Hz					
Cooling capacity ¹	kW	14.0	22.4	28.0			
	Btu/h	47,800	76,400	95,500			
Heating capacity ²	kW	8.9	13.9	17.4			
	Btu/h	30,400	47,400	59,400			
Temperature range	Cooling	17°C D.B./15.5°C W.B. + 43°C D.B./35°C W.B. Thermo-off (FAN-mode) automatically starts if the outdoor temperature is lower than 17°C D.B.					
	Heating	+10°C D.B. + 20°C D.B. Thermo-off (FAN-mode) automatically starts if the outdoor temperature is higher than 20°C D.B.					
Power input ³	Cooling kW	0.220	0.260	0.350			
	Heating kW	0.230	0.270	0.360			
Current input ³	Cooling A	1.43	1.66	2.16			
	Heating A	1.52	1.85	2.38			
External finish		Galvanized					
External dimension HxWxD	mm	380x1195x900	470x1250x1120	470x1250x1120			
Net weight	kg	49	78	81			
Heat exchanger		Cross fin (aluminum fin and copper tube)					
Motor	Type	DC Motor					
	Output kW	0.244	0.375	0.375			
Refrigerant piping diameter	Gas (brazed) mm	15.88	19.05	22.22			
	Liquid (brazed) mm	9.52	9.52	9.52			
Field drain pipe size	mm	O.D. 32	O.D. 32	O.D. 32			
Fan	Type x Quantity	Sirocco fan x 1	Sirocco fan x 2	Sirocco fan x 2			
	External static press. ⁴ Pa	<100> - <150> - 200 - <250>					
	Air flow rate ⁵		Normal Airflow rate mode	High Airflow	Normal Airflow	High Airflow	Normal Airflow
m ³ /min		14.0 - 15.5 - 18.0	15.5 - 18.0 - 20.0	22.5 - 25.0 - 28.0	25.0 - 28.0 - 32.0	28.0 - 31.0 - 35.0	31.0 - 35.0 - 40.0
L/s		233 - 258 - 300	258 - 300 - 333	375 - 417 - 467	417 - 467 - 533	467 - 517 - 583	517 - 583 - 667
cfm	494 - 547 - 636	547 - 636 - 706	794 - 883 - 898	883 - 989 - 1,130	989 - 1,095 - 1,236	1,095 - 1,236 - 1,412	
Sound pressure level ² (Low-Mid-High)		Normal Airflow	High Airflow	Normal Airflow	High Airflow	Normal Airflow	High Airflow
	dB(A)	34-37-41	36-40-42	35-38-41	36-39-42	38-40-44	38-41-45

¹Cooling capacity indicates the maximum value at operation under the following condition. Cooling: Indoor 33°CDB/28°CWB, Outdoor 33°CDB. The set temperature of the remote controller is 18°C.

²Heating capacity indicates the maximum value at operation under the following condition. Heating: Indoor 0°CDB/-2.9°CWB, Outdoor 0°CDB/-2.9°CWB. The set temperature of the remote controller is 25°C.

³The value are measured at the factory setting of airflow mode and external static pressure.

⁴The factory setting of airflow mode and external static pressure mode is shown without <>. Refer to "Fan characteristics curves", according to the external static pressure, in DATA BOOK for the usable range of air flow rate.

⁵If the airflow rate is over the usable range, dew drop can be caused from the air outlet and the air flow rate is changed automatically because of the output down by the fan motor control. If the air flow rate is less than the usable range, condensation from the unit surface can be caused.

The combination of fresh air intake type indoor units with other types of indoor units to handle internal thermal load which may cause the conflict of operation mode. It is not recommended when fresh air intake type indoor unit is connected to the Y or WY series.

Depending on the air conditioning load, outside temperature, and due to the activation of protection functions, the desired preset temperature may not always be achieved and the discharge temperature may swing. Note that untreated outside air may be delivered directly into the room upon the activation of protection functions.

Fresh air intake type indoor units cannot be connected to PUMY and cannot be connected to an outdoor unit together with PWFY series.

The maximum connectable indoor units to 1 outdoor unit are 110% (100% in case of heating below -5°C).

When fresh air intake type indoor units connect to an outdoor unit together with other types of indoor unit, the total capacity of fresh air intake type indoor units needs to be 30% or less of the connected outdoor unit capacity.

The AUTO mode on the local remote controller is available only when fresh air intake type indoor unit is connected to the R2 or WR2 series of outdoor unit.

The system changeover function is available only when all the connected indoor units are fresh air intake type indoor units.

The fan temporarily stops during defrost.

The cooling and heating capacities are the maximum capacities that were obtained by operating in the above air conditions and with a refrigerant pipe of about 7.5 m and a level difference of 0 m.

The actual capacity characteristics vary with the combination of indoor and outdoor units. See the technical information in DATA BOOK for the details.

Thermo off (Fan) operation automatically starts either when temperature is lower than 17°CDB in cooling mode or when the temperature exceeds 20°CDB in heating mode.

Dry mode is not available.

When this unit is used as sole A/C system, be careful about the dew in air outlet grilles in cooling mode.

Un-conditioned outdoor air such as humid air or cold air blows to the indoor during thermo off operation. Please be careful when positioning indoor unit air outlet grilles, ie take the necessary precautions for cold air, and also insulate rooms for dew condensation prevention as required.

Air filter must be installed in the air intake side. The filter should be attached where easy maintenance is possible in case of usage of field supply filters.

LGH-RVS

DUCTED SENSIBLE HEAT RECOVERY UNIT

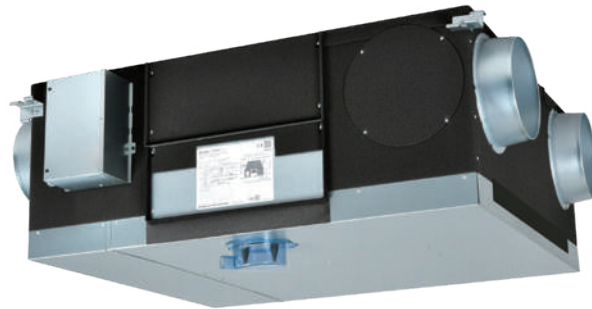

SIZES	
LGH-50RVS	500 mc/h @ 150 Pa
LGH-80RVS	800 mc/h @ 170 Pa
LGH-1000RVS	1000 mc/h @ 190 Pa

Standard filter (provided with the unit)	Optional filter
G3 (Coarse 50%)	F8 (ePM1 65%)

Ideal for...

Ducted indoor unit equipped with fresh air intake fan, exhaust fan, filtering system, Lossnay sensitive heat recovery system and bypass damper.

Sensible heat recovery unit

The new Lossnay LGH-RVS sensible heat recovery unit caters to different needs thanks to its features and accessories. Ease of installation, ultra-quiet operation and recovery efficiency are the three key features of this model.

CO₂ sensor (optional)

A CO₂ sensor connected directly to the unit means that the airflow rate can be optimised according to the level of carbon dioxide detected in the room, improving heat exchange efficiency and contributing to energy saving.

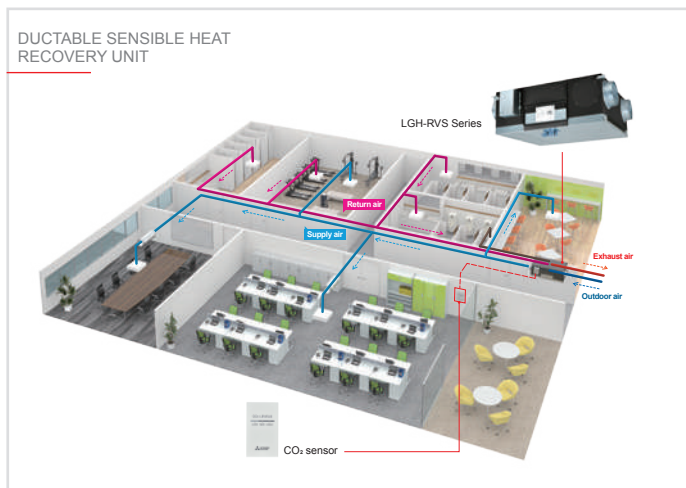

AIRFLOW MODULATION WITH CO₂ SENSOR



OPTIONAL CO₂ SENSOR



PZ-70CSW-E (sensor for wall-mounted installation). The CO₂ levels are indicated by the LEDs on the sensor.



PZ-70CSB-E (sensor built into the unit)

Easy installation

Lighter weight

Being lightweight is one of the most important factors in installation. The lightweight frame of the LGH-RVS series can provide a huge advantage in terms of installation cost and safety.

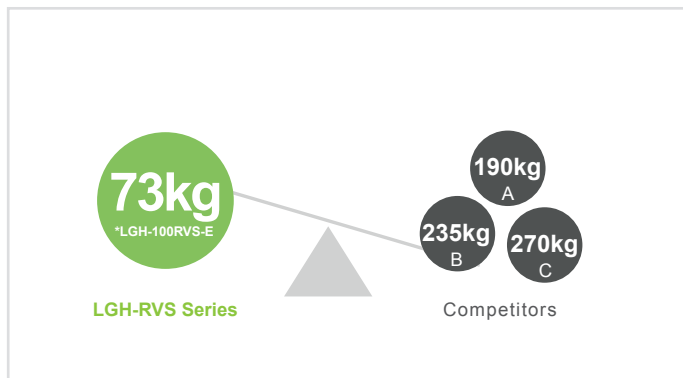

Silent and efficient operation

The new LGH-RVS recovery unit has extremely low noise emissions thanks to the special sirocco fan produced by Mitsubishi Electric coupled with a high-efficiency motor.



Single condensate drain

The LGH-RVS unit is equipped with a special condensate drain that allows the connection of a single condensate evacuation pipe. Connection to the pipeline is made easy thanks to the rotating connection system. Furthermore, thanks to the special design of the new drainage system, there is no need for an external siphon.

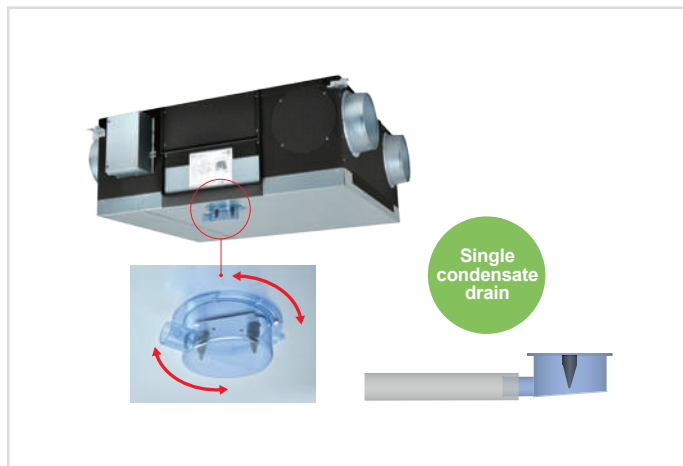

Dedicated PZ-62DR-EB wired controller

The new PZ-62DR-EB controller can be used to control all the functions of the LGH-RVS unit.

If the PZ-70CSW-E (optional) or PZ-70CSB-E (optional) CO₂ sensor is used, the carbon dioxide concentration in the room can be displayed on the control unit's display.

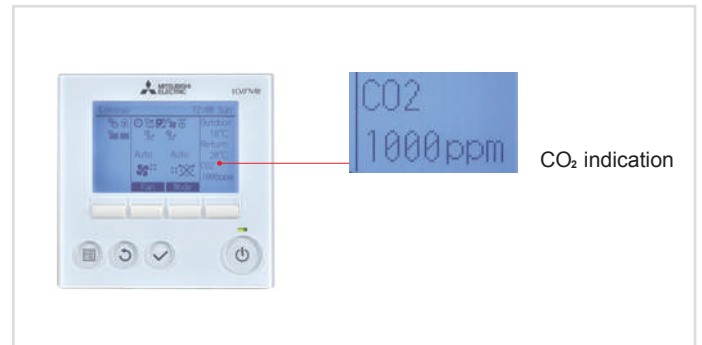

Customisable filtration level

The new LGH-RVS is fitted with G3 filters (Coarse 50%) as standard. F8 filters can be used for higher performance filtration.

Filter Model	Class. EN779:2012	Class. ISO16890:2016	No. filters per set	Compatible VL model	Filter position	Maintenance	Filter life*
PZ-S50RF-E	G3	Coarse 55%	2	LGH-50RVS-E	RA, OA	Clean the air filter once a year	Approx. 5 years with periodic cleaning/maintenance
PZ-S80RF-E				LGH-80RVS-E			
PZ-S100RF-E				LGH-100RVS-E			
PZ-S50RFH-E	F8	ePM1 65%	2	LGH-50RVS-E	SA	Disposable filter. No cleaning/washing	Approximately one year or when blocked
PZ-S80RFH-E				LGH-80RVS-E			
PZ-S100RFH-E				LGH-100RVS-E			

Airflow modulation

The fan inverter motor, designed and manufactured directly by Mitsubishi Electric, guarantees maximum performance with minimum energy consumption and allows **inlet and outlet ventilation speed modulation from 25% to 100%** (+/- 5% increments/decrements).

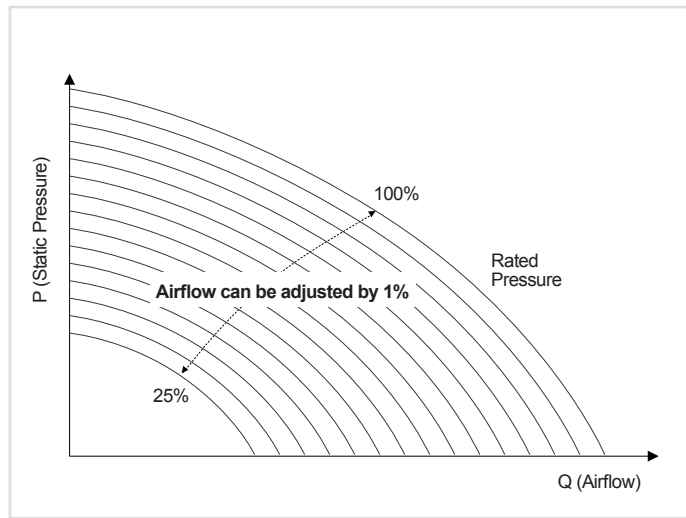

MELCloud connection (optional)

The unit can be controlled and monitored remotely via the **MeICloud** platform. This requires the installation of the optional **MAC-587IF-E** interface card.



Technical data LGH-50RVS-E

MODEL		LGH-50RVS-E			
Electrical power supply	V/Phase/Hz	220-240/MONOPHASE /50			
Fan speed		100%	75%	50%	25%
Input power	W	190	110	60	25
Air volume	m³/h	500	375	250	125
	L/s	139	104	69	35
External static pressure	Pa	150	84	38	9
Sensible heat exchange efficiency	%	87	89	91	93
Standard filter	EN 779 (ISO 16890)	G3 (Coarse 35%)			
Noise	dB(A)	33	27	22	18
Weight	kg	55			
Dimensions	HxLxD	mm 529 x 974 x 946			
Guaranteed field of operation (continuous operation)*	Outdoor temp.	°C	0 ~ +40		
	Max. indoor temp.	%	40		
	Max. indoor RU	°C	90		
	Max. indoor AH	%	0.0139		

DIAGRAM LGH-50RVS-E

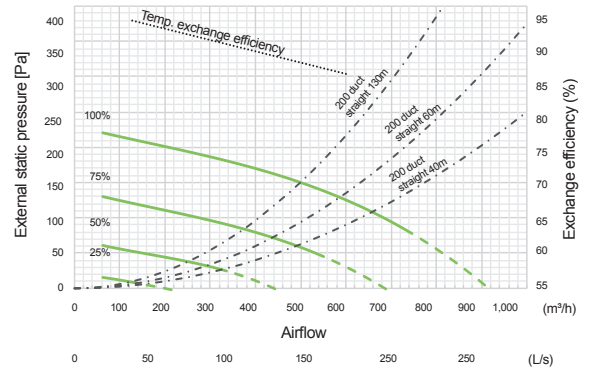

Technical data LGH-80RVS-E

MODEL		LGH-80RVS-E			
Electrical power supply	V/Phase/Hz	220-240/MONOPHASE /50			
Fan speed		100%	75%	50%	25%
Input power	W	325	175	85	32
Air volume	m³/h	800	600	400	200
	L/s	222	167	111	56
External static pressure	Pa	170	96	43	11
Sensible heat exchange efficiency	%	82	84	86	90
Standard filter	EN 779 (ISO 16890)	G3 (Coarse 35%)			
Noise	dB(A)	36	30	25	18
Weight	kg	63			
Dimensions	HxLxD	mm 529 x 1185 x 997			
Guaranteed field of operation (continuous operation)*	Outdoor temp.	°C	0 ~ +40		
	Max. indoor temp.	%	40		
	Max. indoor RU	°C	90		
	Max. indoor AH	%	0.0139		

DIAGRAM LGH-80RVS-E

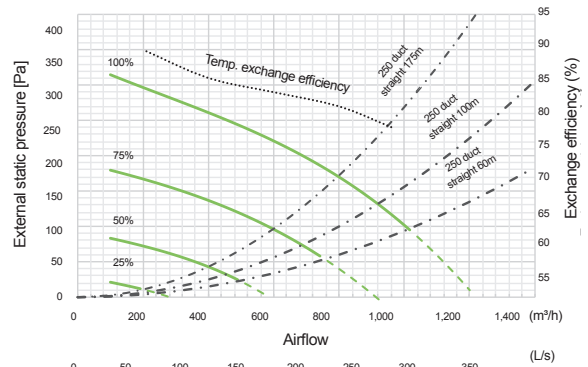

Technical data LGH-100RVS-E

MODEL		LGH-100RVS-E			
Electrical power supply	V/Phase/Hz	220-240/MONOPHASE /50			
Fan speed		100%	75%	50%	25%
Input power	W	445	225	100	35
Air volume	m³/h	1000	750	500	250
	L/s	278	208	139	69
External static pressure	Pa	190	107	48	12
Sensible heat exchange efficiency	%	82	84	86	90
Standard filter	EN 779 (ISO 16890)	G3 (Coarse 35%)			
Noise	dB(A)	37	32	24	18
Weight	kg	73			
Dimensions	HxLxD	mm 529 x 1185 x 1224			
Guaranteed field of operation (continuous operation)*	Outdoor temp.	°C	0 ~ +40		
	Max. indoor temp.	%	40		
	Max. indoor RU	°C	90		
	Max. indoor AH	%	0.0139		

DIAGRAM LGH-100RVS-E

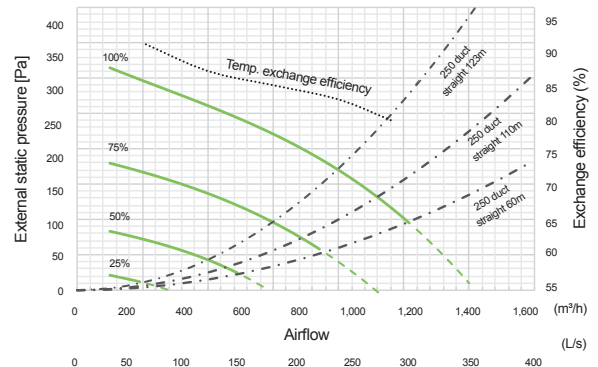

LGH-RVX3 NEW

HEAT RECOVERY UNIT FOR DUCTED INSTALLATIONS



BMS connectivity	Accessories
Modbus	Procon A1M
MELCloud connectivity	
YES with MAC-587IF-E interface	

Standard filter (included with unit)	Optional filter
Coarse 60% (equivalent to G4)	ePM1 75% (equivalent to F8)



SIZE	
LGH-65RVX3-E	150 Pa @ 650 m³/h
LGH-80RVX3-E	170 Pa @ 800 m³/h
LGH-100RVX3-E	190 Pa @ 1000 m³/h
LGH-160RVX3-E	170 Pa @ 1600 m³/h
LGH-200RVX3-E	170 Pa @ 2000 m³/h

Ideal for...

Ducted indoor unit for **horizontal or vertical** (with optional accessory) installation, with inlet and exhaust fans equipped with **EC motor** with broad speed modulation range (**25-100%**), integrated filtration system, Lossnay enthalpic heat recovery module and bypass damper.

LOSSNAY – Heat recovery ventilation units

The importance of adequate air exchange

Air quality is a primary parameter for comfort. Poor air quality in the office or at home has been proven to have a significantly detrimental influence on productivity and on the healthiness of the environment, and contribute to fatigue. This is due to increasing concentrations of CO2 caused by inadequate air exchange. To live comfortably, every individual needs 400l of fresh air per hour. Ensuring adequate ventilation in residential and commercial buildings is necessary to offer a healthy, comfortable environment for all occupants.

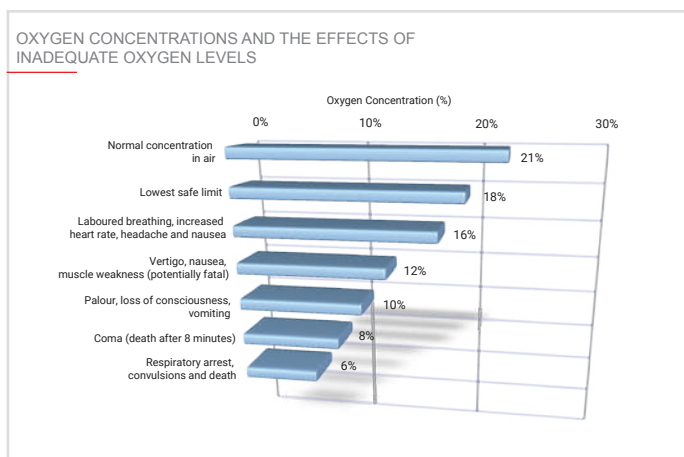

The importance of correctly controlled humidity

A dry environment offers the ideal conditions for the proliferation of bacteria and viruses, and the survival rate of these micro-organisms drops rapidly at relative humidity levels above 50%. Excessively humid environments, on the other hand, encourage the proliferation of mould and mites. Precise humidity control is therefore an important factor in maintaining the ideal, healthy conditions.

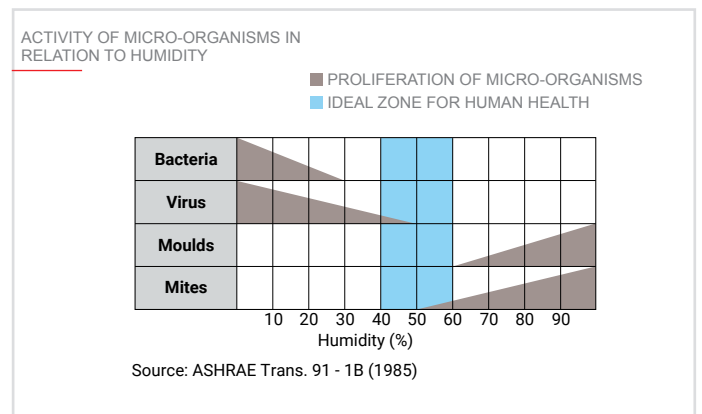

Low noise

Precise control over the flow of treated air significantly reduces the sound pressure values of the LOSSNAY unit by up to 17 dB(A). All LGH-RVX3 units ensure ideal acoustic comfort, even for residential applications, libraries, offices etc.



Simple construction

As shown in the figure, the Lossnay exchanger consists of a structure in special treated paper allowing two different air flows to cross one another and exchange thermal energy. Partitions separating the inlet and outlet channels prevent incoming fresh air from ever mixing with outgoing air.

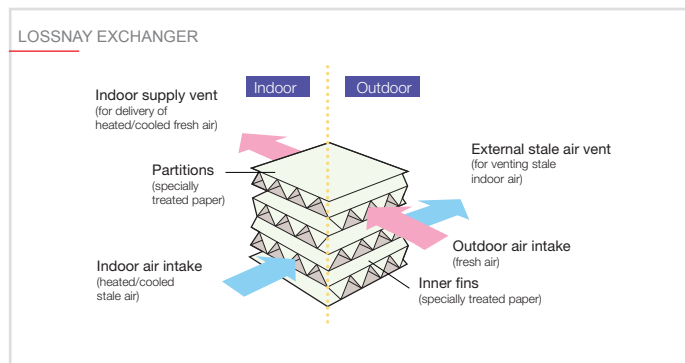

Operating principle

The Lossnay exchanger performs a highly effective total exchange action for both temperature (sensible heat) and humidity (latent heat) – the system uses moisture-permeable partitions in specially treated paper to allow stale air to be vented externally and fresh outdoor air to be fed to the indoor space with absolutely no mixing between the two air flows.

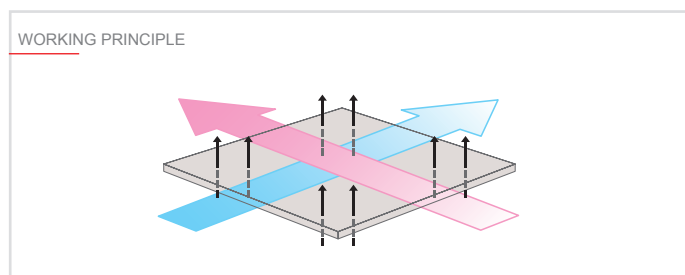

New PZ-62DR-EB dedicated remote control

NEW

The new wired remote control unit specifically for LGH-RVX3, LGH-RVS and LGH-RVXT heat recovery units boasts a fresh new look and new features:

- Manage a group of up to 15 units
- Simple and intuitive.
- Backlit LCD screen
- "Lossnay" logo
- New "Pure White" colour
- Internal weekly timer
- Custom ventilation strategies for mode switching (Auto/recovery/bypass)
- Night purge function for active night-time ventilation in summer..



Flow rate control

NEW

Both the fans of the new LGH-RVX3 can operate at 4 different pre-set ventilation speeds.

The desired speed setting can be selected independently for each of the two fans from the dedicated PZ-62DR-EB controller. Moreover, the new EC motors also allow each of the 4 set speeds to be increased or decreased within a range from 25% to 100%, letting the user fine-tune the performance of the air distribution system to perfection and reduce energy consumption.

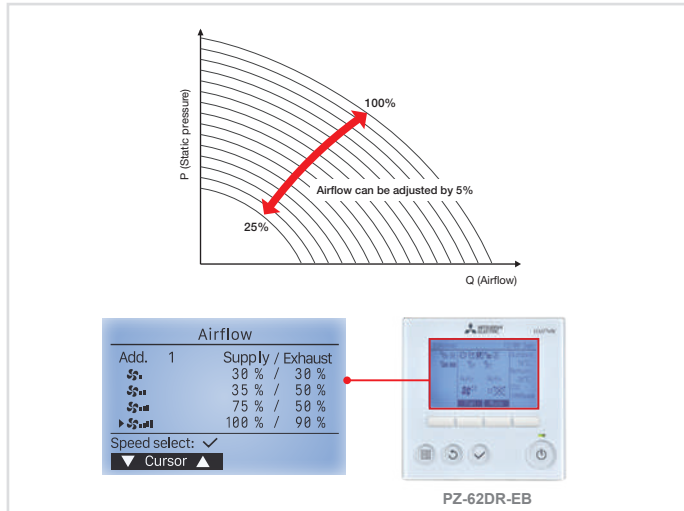

Dual Barrier Coating protective surface treatment

NEW

The new LGH-RVX3 heat recovery module uses Dual Barrier Coating technology. During operation, dust and contaminants carried by the air accumulate on the internal components of the unit, and especially on the fans, increasing energy consumption. The Dual Barrier Coating applied to both of the fans of the unit forms an additional protective layer which impedes the accumulation of dust and contaminants, even after prolonged usage, and eliminates the need for maintenance to address this problem.

Dual Barrier Coating

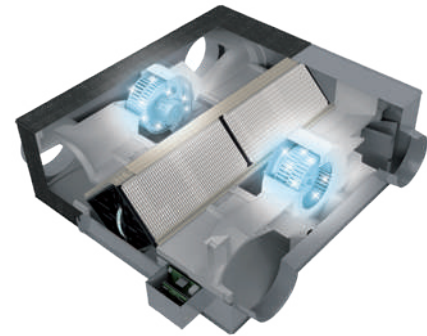

*The Dual Barrier Coating treatment is applied to both the inlet and exhaust fans

New CO₂ sensor

NEW

The optional CO₂ sensor lets the controller of the unit modulate the recirculated air flow in relation to the concentration of carbon dioxide detected by the sensor itself. This also increases heat exchange efficiency and contributes to saving energy.

NEW CO₂ SENSOR

CO₂ sensor for wall-mounted installation (PZ-70CSW-E)

or

CO₂ sensor for ducted installation (PZ-70CSD-E)

Two different CO₂ sensor versions are available, one for wall-mounted installations and the other for ducted installations. The sensors receive electrical power from the board of the LGH unit. Fan speed is modulated in 16 steps within a range from 25% at 100% in relation to the CO₂ levels measured in the ambient air

CO ₂ control	
*CO ₂ control	No / Yes
CO ₂ upper limit	1600 ppm
CO ₂ lower limit	450 ppm

Select:
 ▼ Cursor ▲ ◀ Cursor ▶

The upper and lower CO₂ limits are user-settable. Upper limit: from 600 to 2,000 ppm. Lower limit: from 300 to (upper limit -300) ppm. 50 ppm steps.

AUTOMATIC OPERATION WITH CO₂ SENSOR
 Fan speed is adjusted automatically in relation to the CO₂ concentration measured by the sensor

Low CO₂ density

High CO₂ density

Comfortable air renewal action in either cold or hot outdoor conditions

Summer - Difference in temperature between new fresh air and air already in room of only 1.7°C.
 • Incoming fresh air is brought to the same conditions as the cooled (and dehumidified) air in the room.

Winter - 4 kg/h humidity recovered.
 • Incoming fresh air is brought to the same conditions as the warmed (and humidified) air in the room.

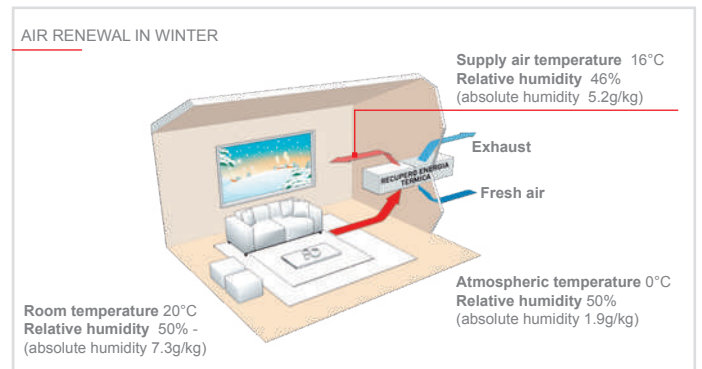
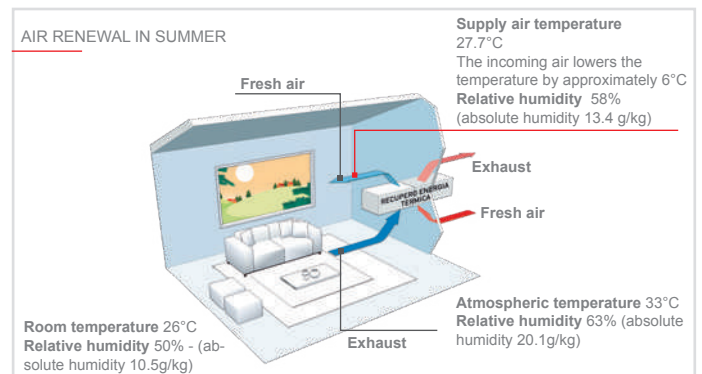

Horizontal or vertical installation



The LGH-RVX3 offers even more flexibility for installation. The optional new dedicated mounts allow the unit to also be installed in a vertical position, so it can be installed not only in false ceilings but also in spaces such as alcoves, wall cavities and utility rooms.

MODEL CODE FOR VERTICAL INSTALLATION		LOSSNAY
PZ-1VS-E		LGH-50RVX3-E
PZ-2VS-E		LGH-65RVX3-E
		LGH-80RVX3-E
		LGH-100RVX3-E

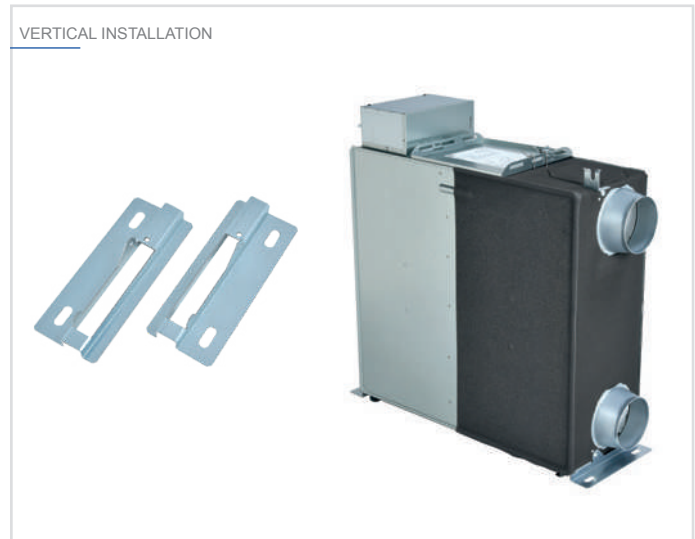

Technical specifications

MODEL		LGH-65RVX3-E				
Power supply	V/Phases/Hz	220-240 / SINGLE PHASE /50; 220-240 / SINGLE PHASE / 60				
Specific energy consumption class ¹ (SEC)						
ErP data ¹	Max. air flow	m ³ /h	650			
Fan speed			SP4	SP3	SP2	SP1
Factory flow rate setting (modifiable)			100%	75%	50%	25%
Power consumption		W	245	120	51	20
Treated air volume		m ³ /h	650	488	325	163
Static external pressure		Pa	150	85	38	10
Sensible heat exchange efficiency	Cooling	%	65	70	74,5	80
	Heating	%	72,5	75	78,5	82
Enthalpic exchange efficiency	Cooling	%	50,5	55	61,5	69
	Heating	%	69,5	72	76,5	80
Standard filter	ISO 16890		Coarse 60%			
Sound pressure		dB(A)	37,5	31,5	24	17,5
No. and diameter of channels		mm	4 x 200			
Weight		kg	41			
Dimensions	HxLxW	mm	404 x 954 x 908			
	Outd. Temp.	°C	-10 ~ +40			
	Max. outd. RH	%	80			
	Max. ind. Temp.	°C	40			
Continuous operation range*	Max. ind. RH	%	80			

Technical specifications

MODEL		LGH-80RVX3-E				
Power supply	V/Phases/Hz	220-240 / MONOPHASE /50; 220-240 / MONOPHASE / 60				
Specific energy consumption class ¹ (SEC)						
ErP data ¹	Max. air flow	m ³ /h	800			
Fan speed			SP4	SP3	SP2	SP1
Factory flow rate setting (modifiable)			100%	75%	50%	25%
Power consumption		W	343	160	64	23
Treated air volume		m ³ /h	800	600	400	200
Static external pressure		Pa	170	96	43	11
Sensible heat exchange efficiency	Cooling	%	65	70	75,5	78
	Heating	%	75	76,5	78	80
Enthalpic exchange efficiency	Cooling	%	52	56	62,5	68
	Heating	%	62	65	70,5	73,5
Standard filter	ISO 16890		Coarse 60%			
Sound pressure		dB(A)	39	33,5	25	18
No. and diameter of channels		mm	4 x 250			
Weight		kg	47			
Dimensions	HxLxW	mm	404 x 1004 x 1144			
	Outd. Temp.	°C	-10 ~ +40			
	Max. outd. RH	%	80			
	Max. ind. Temp.	°C	40			
Continuous operation range*	Max. ind. RH	%	80			

¹According to EU Regulation 1254/2014

*At temperatures <-10°C, the fan functions intermittently. In these conditions, we recommend using a heater unit that may be controlled by the LOSSNAY unit

DIAGRAM LGH-65RVX3-E

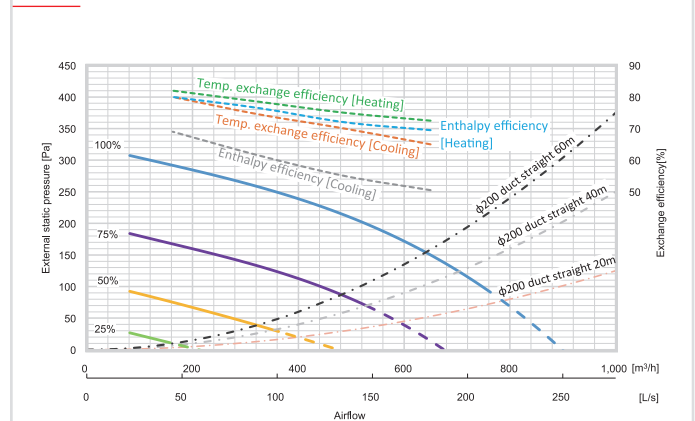

*The dotted ventilation curves are for reference values which cannot be measured

For LGH-RVX3 series

The values for power consumption, efficiency and noise are determined for the reference conditions specified with a mains power supply of 230V/50Hz and with the unit in a horizontal installation configuration.

DIAGRAM LGH-80RVX3-E

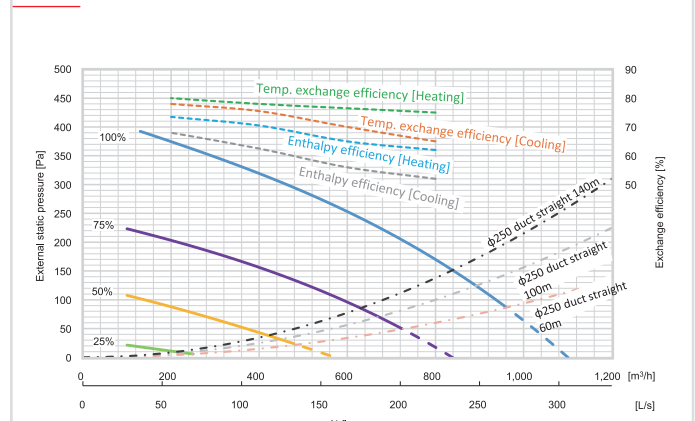

*The dotted ventilation curves are for reference values which cannot be measured

For LGH-RVX3 series

The values for power consumption, efficiency and noise are determined for the reference conditions specified with a mains power supply of 230V/50Hz and with the unit in a horizontal installation configuration.

Technical specifications

MODEL		LGH-100RVX3-E				
Power supply	V/Phases/Hz	220-240 / MONOPHASE / 50; 220-240 / MONOPHASE / 60				
Specific energy consumption class ¹ (SEC)	A (Average: -39.7 kWh/(m2.a))					
ErP data ¹	Max. air flow	m ³ /h	1000			
Fan speed			SP4	SP3	SP2	SP1
Factory flow rate setting (modifiable)			100%	75%	50%	25%
Power consumption		W	438	210	83	27
Treated air volume		m ³ /h	1000	750	500	250
Static external pressure		Pa	190	107	48	12
Sensible heat exchange efficiency	Cooling	%	67,5	72	77	82,5
	Heating	%	75,5	77	79,5	83,5
Enthalpic exchange efficiency	Cooling	%	53,5	59	64	71,5
	Heating	%	60,5	63	68,5	75,5
Standard filter	ISO 16890	Coarse 60%				
Sound pressure		dB(A)	40	35	27	18,5
No. and diameter of channels		mm	4 x 250			
Weight		kg	53			
Dimensions	HxLxW	mm	404 x 1231 x 1144			
	Outd. Temp.	°C	-10 ~ +40			
Continuous operation range*	Max. outd. RH	%	80			
	Max. ind. Temp.	°C	40			
	Max. ind. RH	%	80			

DIAGRAM LGH-100RVX3-E

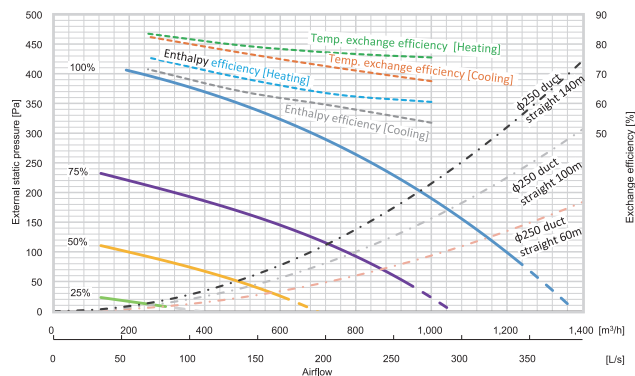

*The dotted ventilation curves are for reference values which cannot be measured

For LGH-RVX3 series
The values for power consumption, efficiency and noise are determined for the reference conditions specified with a mains power supply of 230V/50Hz and with the unit in a horizontal installation configuration.

Technical specifications

MODEL		LGH-160RVX3-E				
Power supply	V/Phases/Hz	220-240 / MONOPHASE / 50; 220-240 / MONOPHASE / 60				
Specific energy consumption class ¹ (SEC)	A (Average: -39.0 kWh/(m2.a))					
ErP data ¹	Max. air flow	m ³ /h	1600			
Fan speed			SP4	SP3	SP2	SP1
Factory flow rate setting (modifiable)			100%	75%	50%	25%
Power consumption		W	687	324	128	45
Treated air volume		m ³ /h	1600	1200	800	400
Static external pressure		Pa	170	96	43	11
Sensible heat exchange efficiency	Cooling	%	65	70	75,5	78
	Heating	%	75	76,5	78	80
Enthalpic exchange efficiency	Cooling	%	52	56	62,5	68
	Heating	%	62	65	70,5	73,5
Standard filter	ISO 16890	Coarse 60%				
Sound pressure		dB(A)	41	35	26	18
No. and diameter of channels		mm	4 x 250			
Weight		kg	98			
Dimensions	HxLxW	mm	690 x 690 x 1004			
	Outd. Temp.	°C	-10 ~ +40			
Continuous operation range*	Max. outd. RH	%	80			
	Max. ind. Temp.	°C	40			
	Max. ind. RH	%	80			

DIAGRAM LGH-160RVX3-E

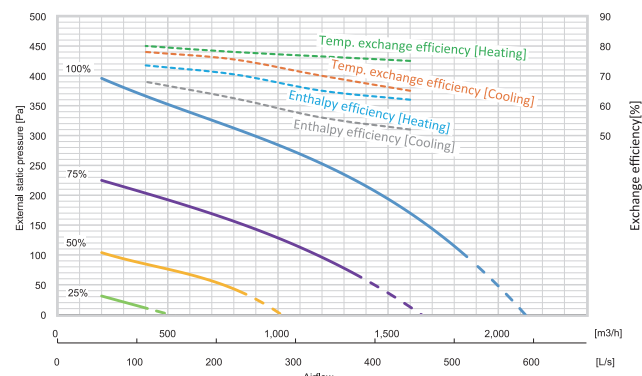

*The dotted ventilation curves are for reference values which cannot be measured

For LGH-RVX3 series
The values for power consumption, efficiency and noise are determined for the reference conditions specified with a mains power supply of 230V/50Hz and with the unit in a horizontal installation configuration.

¹According to EU Regulation 1254/2014
*At temperatures <-10°C, the fan functions intermittently. In these conditions, we recommend using a heater unit that may be controlled by the LOSSNAY unit

Technical specifications						
MODEL		LGH-200RVX3-E				
Power supply	V/Phases/Hz	220-240 / MONOPHASE / 50; 220-240 / MONOPHASE / 60				
Specific energy consumption class ¹ (SEC)		A (Average: -39.7 kWh/(m2.a))				
ErP data ¹	Max. air flow	m ³ /h	2000			
Fan speed			SP4	SP3	SP2	SP1
Factory flow rate setting (modifiable)			100%	75%	50%	25%
Power consumption		W	855	416	163	57
Treated air volume		m ³ /h	2000	1500	1000	500
Static external pressure		Pa	170	96	43	11
Sensible heat exchange efficiency	Cooling	%	66,5	71,5	76	82,5
	Heating	%	76,5	77,5	79,5	83,5
Enthalpic exchange efficiency	Cooling	%	57	59,5	64,5	70
	Heating	%	60,5	64	67,5	76
Standard filter	ISO 16890		Coarse 60%			
Sound pressure		dB(A)	41,5	36	27,5	18
No. and diameter of channels		mm	4 x 250			
Weight		kg	110			
Dimensions	HxLxW	mm	917 x 917 x 1231			
Continuous operation range*	Outd. Temp.	°C	-10 ~ +40			
	Max. outd. RH	%	80			
	Max. ind. Temp.	°C	40			
	Max. ind. RH	%	80			

¹According to EU Regulation 1254/2014

*At temperatures <-10°C, the fan functions intermittently. In these conditions, we recommend using a heater unit that may be controlled by the LOSSNAY unit

DIAGRAM LGH-200RVX3-E

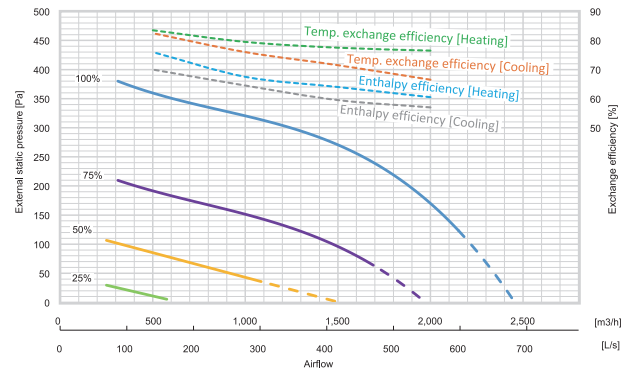

*The dotted ventilation curves are for reference values which cannot be measured

For LGH-RVX3 series

The values for power consumption, efficiency and noise are determined for the reference conditions specified with a mains power supply of 230V/50Hz and with the unit in a horizontal installation configuration.

LGH-RVXT

LOSSNAY - Heat recovery ventilation unit



Standard filter (provided with the unit)	Optional filter
Standard filter G3 - Coarse 35%	High efficiency filter M6 - ePM10 75%
	High efficiency filter ePM1 75% (equivalent to F8)

Ideale per....

Unità interna canalizzata compatta per elevate portate d'aria munita di ventilatore di immissione e di rinnovo, ventilatore di espulsione dell'aria viziata, sistema filtrante, recuperatore di calore totale Lossnay e serranda di by-pass.

Elevati volumi di aria e altezza ridotta

La Linea di recuperatori entalpici LGH si arricchisce con l'introduzione di un nuovo modello dalle importanti novità.

Il modello **RVXT** è caratterizzato da elevati volumi di aria trattata (fino a 250 m³/h) e da altezze estremamente contenute (**solo 500mm**), caratteristica che lo rende estremamente flessibile in fase di installazione soprattutto dove l'altezza del controsoffitto non permette l'utilizzo del modello RVX. Anche il modello RVXT è dotato di pacco di scambio entalpico in carta trattata ed è equipaggiato, di serie, di filtri ISO COARSE 50% (G3 secondo EN779:2012).

Vantaggi

- Nuovo Design Thin
- Tre taglie disponibili (150, 200 e 250)
- Riduzione dei consumi energetici.
- Riduzione della potenza termica necessaria per il trattamento dell'aria esterna e quindi minore potenza installata.
- Salubrità dell'ambiente.
- Miglior comfort ambientale dovuto ad un miglior controllo dell'umidità relativa.
- Maggior silenziosità (barriera acustica contro i rumori in entrata ed in uscita).
- Facilità di installazione con possibilità di installazione orizzontale e collegamento da due direzioni dei canali che vanno verso l'esterno.
- Possibilità di installazione su impianti esistenti.
- Manutenzione semplificata.
- Sistema a tutta aria esterna (Free Cooling).
- Dimensioni contenute.
- Installabili in controsoffitti ad altezza ridotta.

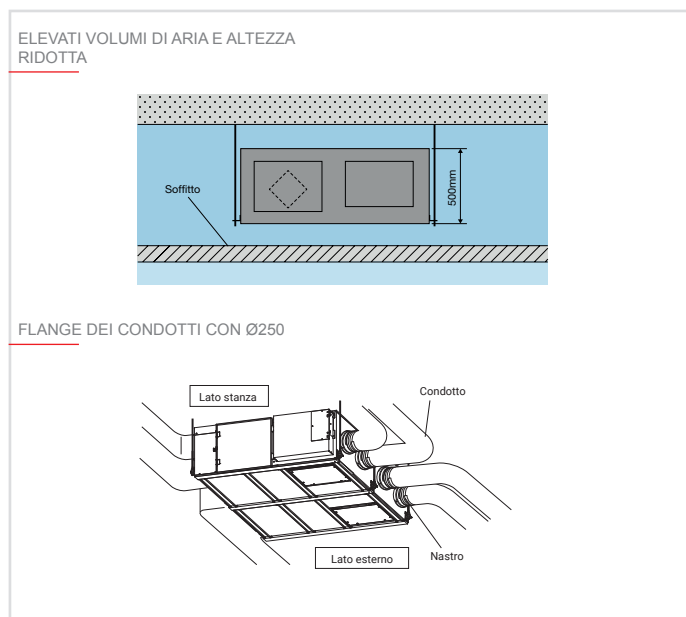

Technical specifications		MODEL				LGH-150RVXT-E					
Power supply	V/Phase/Hz	220-240 / 1-phase /50									
Speed		SP4		SP3		SP2		SP1			
Current	A	4.30 - 3.40		2.40 - 1.80		1.10 - 0.77		0.36 - 0.31			
Power input	W	792 - 625		421 - 334		176 - 134		48 - 37			
Air volume	m³/h	1500		1125		750		375			
	L/s	417		313		208		104			
External static pressure	mmH ₂ O	175		98		44		11			
	Pa	100		56		25		6			
Temp. heat exch. Efficiency	%	80.0		80.5		81.0		81.5			
Total heat exch. Efficiency	Cooling	%		69.0		70.0		72.0		74.0	
	Heating	%		70.0		71.0		73.0		75.0	
Sound pressure level	dB(A)	39.5		35.5		29.5		22.0			
Duct qty x diameter	mm	4 x 250 / 2 x 4 x 250 / 2 x 4 x 250 / 2 x 4 x 250 / 2 x (250x750)		(250x750)		(250x750)		(250x750)			
Wheight	kg	156		156		156		156			
Dimensions	HxLxD	mm		500 x 1980 x 1500		500 x 1980 x 1500		500 x 1980 x 1500		500 x 1980 x 1500	
	Operating field*	Outdoor temp.	°C	-10 ~ +40		-10 ~ +40		-10 ~ +40		-10 ~ +40	
	Max outdoor RH	%	80		80		80		80		
	Max indoor temp	°C	40		40		40		40		
	Max indoor RH	%	80		80		80		80		

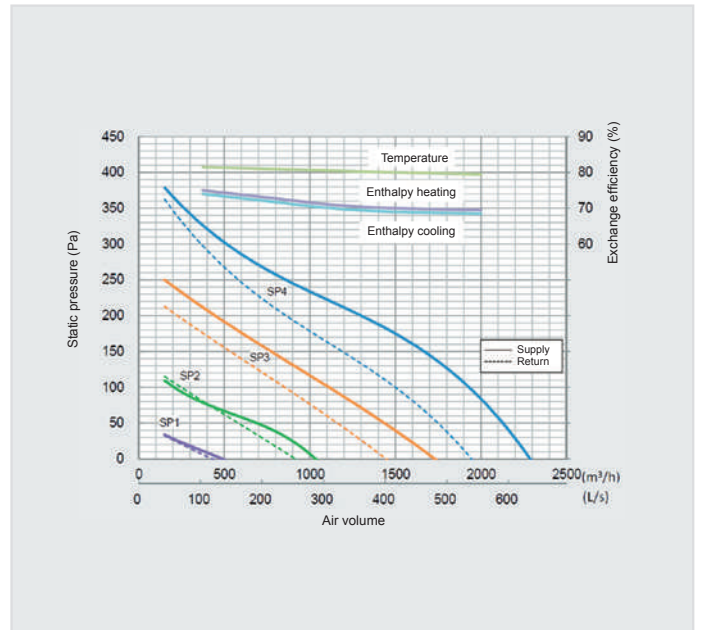

Technical specifications		MODEL				LGH-200RVXT-E					
Power supply	V/Phase/Hz	220-240 / 1-phase /50									
Speed		SP4		SP3		SP2		SP1			
Current	A	5.40 - 5.00		2.70 - 2.20		1.10 - 0.85		0.39 - 0.34			
Power input	W	1000 - 916		494 - 407		197 - 150		56 - 45			
Air volume	m³/h	2000		1500		1000		500			
	L/s	556		417		278		139			
External static pressure	mmH ₂ O	175		98		44		11			
	Pa	100		56		25		6			
Temp. heat exch. Efficiency	%	80.0		81.0		82.5		84.0			
Total heat exch. Efficiency	Cooling	%		70.0		71.0		74.5		80.5	
	Heating	%		72.5		73.5		77.0		83.0	
Sound pressure level	dB(A)	39.5		35.5		28.0		22.0			
Duct qty x diameter	mm	4 x 250 / 2 x 4 x 250 / 2 x 4 x 250 / 2 x (250x750)		(250x750)		(250x750)		(250x750)			
Wheight	kg	159		159		159		159			
Dimensions	HxLxD	mm		500 x 1980 x 1500		500 x 1980 x 1500		500 x 1980 x 1500		500 x 1980 x 1500	
	Operating field*	Outdoor temp.	°C	-10 ~ +40		-10 ~ +40		-10 ~ +40		-10 ~ +40	
	Max outdoor RH	%	80		80		80		80		
	Max indoor temp	°C	40		40		40		40		
	Max indoor RH	%	80		80		80		80		

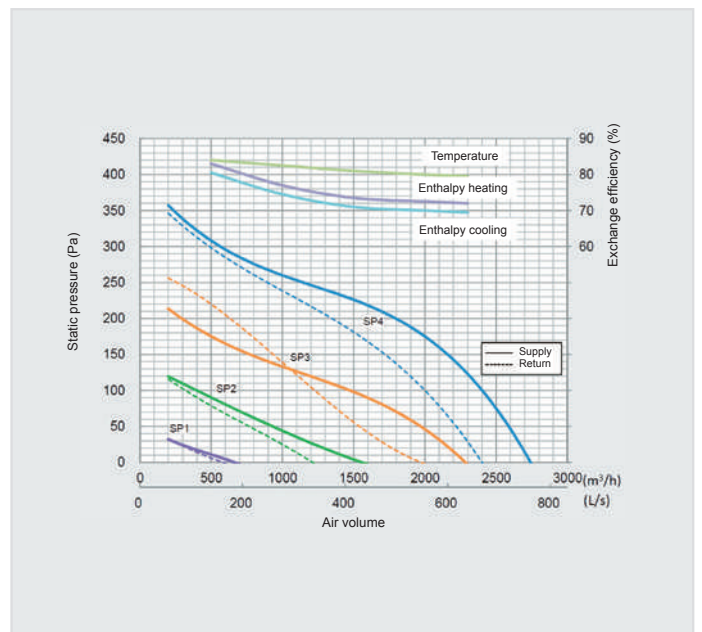

Technical specifications		MODEL				LGH-250RVXT-E					
Power supply	V/Phase/Hz	220-240 / 1-phase /50									
Speed		SP4		SP3		SP2		SP1			
Current	A	7.60 - 6.90		3.60 - 3.10		1.40 - 1.30		0.57 - 0.49			
Power input	W	1446 - 1298		687 - 587		244 - 212		82 - 69			
Air volume	m³/h	2500		1875		1250		625			
	L/s	694		521		347		174			
External static pressure	mmH ₂ O	175		98		44		11			
	Pa	100		56		25		6			
Temp. heat exch. Efficiency	%	77.0		79.0		80.5		82.5			
Total heat exch. Efficiency	Cooling	%		65.5		69.0		71.5		76.5	
	Heating	%		68.0		71.5		74.0		79.0	
Sound pressure level	dB(A)	43.0		39.0		32.0		24.0			
Duct qty x diameter	mm	4 x 250 / 2 x 4 x 250 / 2 x 4 x 250 / 2 x (250x750)		(250x750)		(250x750)		(250x750)			
Wheight	kg	198		198		198		198			
Dimensions	HxLxD	mm		500 x 1980 x 1500		500 x 1980 x 1500		500 x 1980 x 1500		500 x 1980 x 1500	
	Operating field*	Outdoor temp.	°C	-10 ~ +40		-10 ~ +40		-10 ~ +40		-10 ~ +40	
	Max outdoor RH	%	80		80		80		80		
	Max indoor temp	°C	40		40		40		40		
	Max indoor RH	%	80		80		80		80		

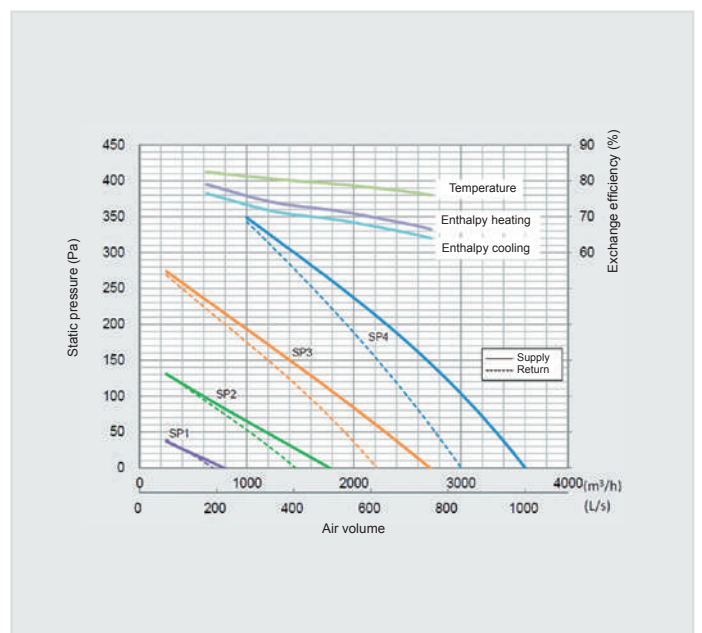

*In case of temperature < -10°C fan will work discontinuously. Lossnay controlled heat generator is recommended in this condition.

GUF-RD(H)4

MONOBLOCK INDOOR UNIT WITH FRESH AIR INTAKE FAN

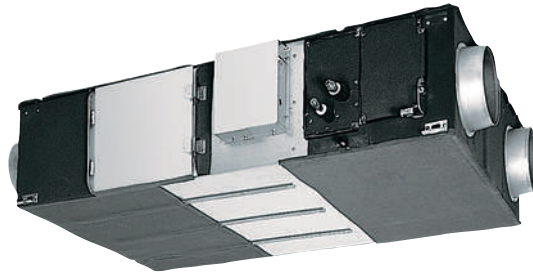

Standard filter (provided with the unit)	Optional filter
Standard filter G3 - Coarse 35%	High efficiency filter M6 - ePM10 75%
	High efficiency filter ePM1 75% (equivalent to F8)

Monoblock indoor unit with fresh air intake fan, stale air exhaust fan, filtration system, Lossnay total heat recovery module, bypass shutter, permeable film humidifier (only for RDH4 version) and direct expansion coil.

Serie RD(H)4

GUF-50RD(H)4

Cooling capacity 5.57 (DX coil: 3.63, Lossnay core: 1.94) kW Heating capacity 6.18 (DX coil: 6.21, Lossnay core: 2.04) kW 500 m³/h 220-240V 50Hz single-phase

GUF-100RD(H)4

Cooling capacity 11.44 (DX coil: 3.63, Lossnay core: 3.85) kW Heating capacity 12.56 (DX coil: 8.30, Lossnay core: 4.26) kW 500 m³/h 220-240V 50Hz single-phase

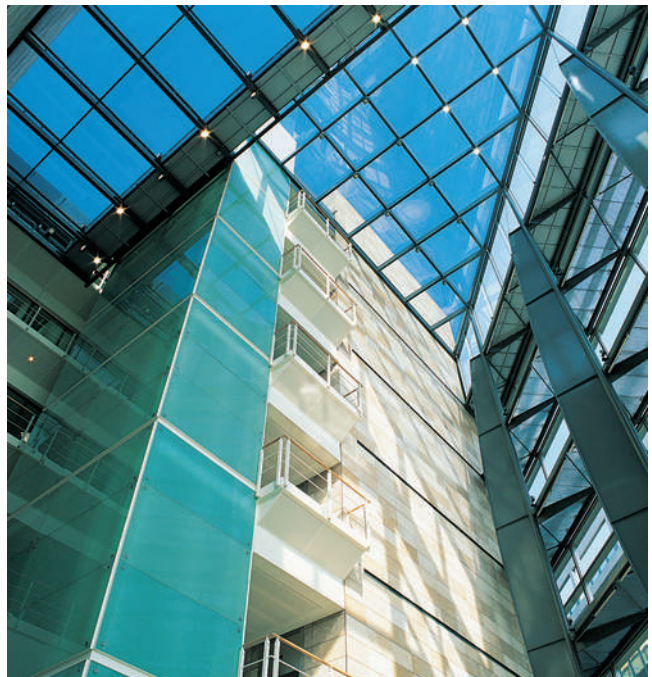

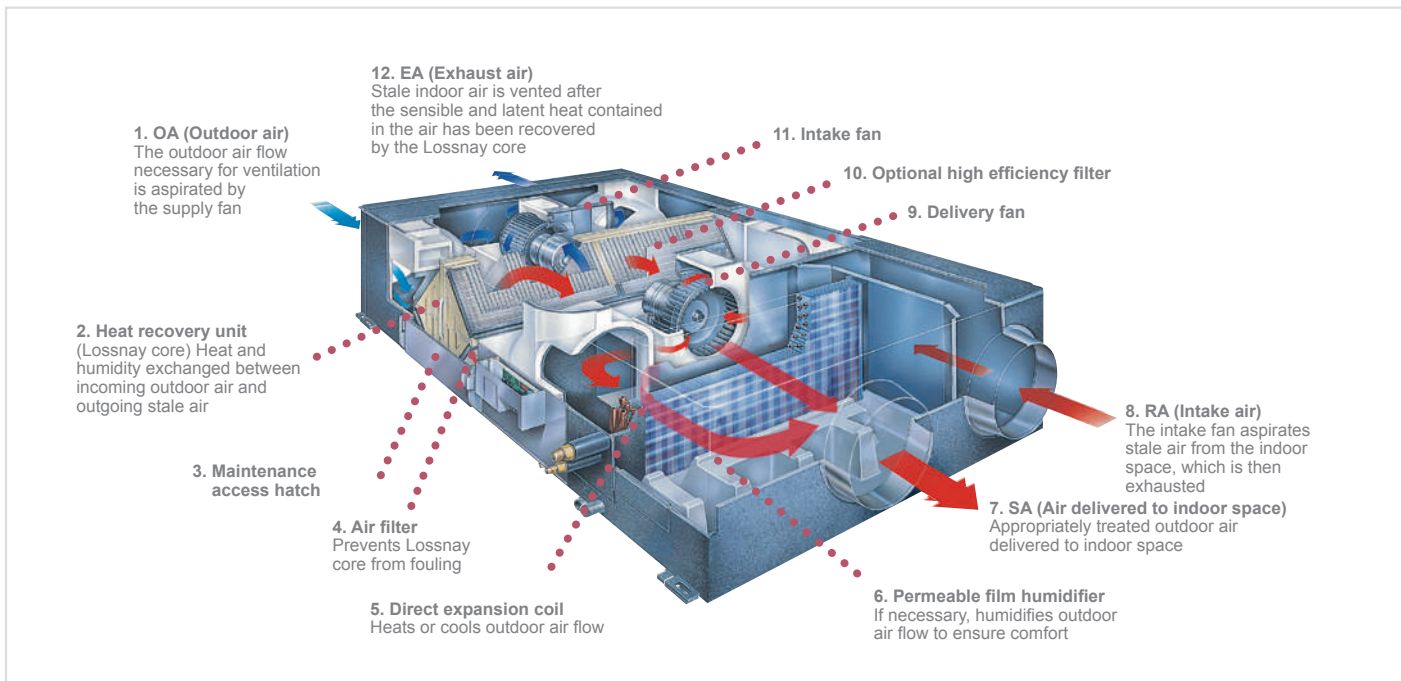

Lossnay technology

The Lossnay total heat recovery module has a cross-flow plate fin structure and heat transfer diaphragms in special treated paper. The excellent thermal transfer properties and permeability to moisture of this special paper ensure the highly efficient exchange of both sensible and latent heat between the two air flows passing through the recovery core. The result is a ventilation system with outstanding characteristics ensuring extremely high levels of comfort and wellbeing in the environment treated, which can also cut operating costs substantially.

The incoming fresh air and outgoing stale air cannot mix within the core. The diaphragm pores, which were already microscopic in previous generations, have been further reduced in size to reduce the possibility of the passage of waterborne soluble gases such as ammonia and hydrogen. To increase heat and moisture exchange, a special treatment is applied to the paper used for the diaphragms. These improvements have increased moisture permeability while reducing permeability to harmful gases, resulting in an overall increase in recovery efficiency and a more effective barrier action against the transfer of these gases.

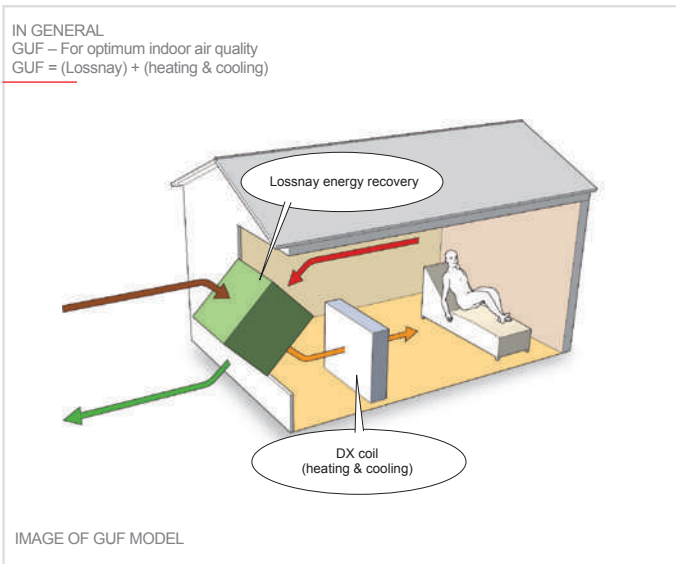

CONSTRUCTION AND OPERATING PRINCIPLE OF LOSSNAY UNIT

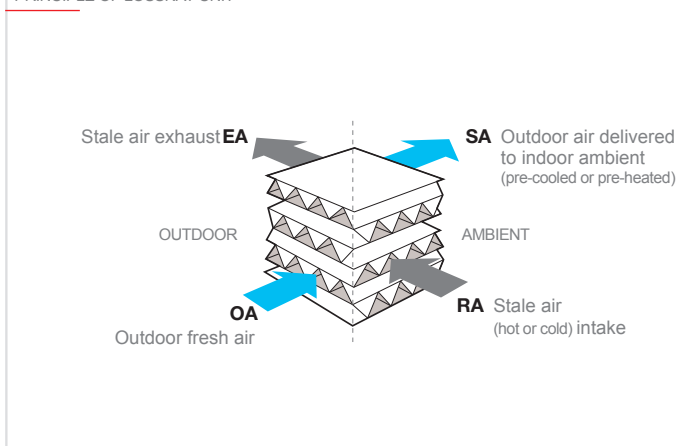

Heat exchanger

A direct expansion coil incorporated in the unit makes it possible to cover approximately 25% of the load of the system with the GUF unit. This also means that the terminal units installed in the indoor space can be smaller. Moreover, as the GUF unit covers the entire thermal load attributable to ventilation, this means that this load and the ambient load can be managed completely separately, simplifying the design process of the installation. The treated air heats the humidifier as it passes through it, further increasing humidification efficiency.

Total comfort

Maintaining the correct humidity levels in an indoor space ensures the ideal conditions for comfort and prevents the unpleasant side-effects typical of an environment with insufficient humidity such as dry eyes and throat.

The evaporation surface area is approximately 8.5 times larger than in a comparably sized natural evaporation humidifier, while performance is 6 times greater.

Humidification - RDH4 version

The innovative permeable film humidification system, which uses a natural evaporation process, is a particularly intelligent solution.

The efficiency with which the air is humidified has been significantly increased by reducing the resistance of the material used. A three-layer film ensures that only the necessary moisture is transferred to the air without any limescale dust release – a problem of certain conventional humidifiers.

Maintaining the correct humidity levels in an indoor space ensures the ideal conditions for comfort and prevents the unpleasant side-effects typical of an environment with insufficient humidity such as dry eyes and throat.

The evaporation surface area is approximately 8.5 times larger than in a comparably sized natural evaporation humidifier, while performance is 6 times greater.

Note: Use a demineraliser if residual total salt levels exceed 100 mg/l.

Increased efficiency of humidification process - RDH4 version

Optimised air flows within the unit together with a water injection system have significantly increased the efficiency of the humidification process. The system also controls the humidity in the outgoing stale air to effectively improve the air quality of the outdoor environment as well. This solution prevents limescale and silica dust from being carried in the air, so purer, less dusty air is vented into the outdoor environment.

Automatic free cooling

When the air conditioning is operating in cooling mode and the outdoor temperature is lower than the indoor ambient temperature (as normally occurs at night-time in summer), the GUF indoor unit recognises this condition and automatically bypasses the recovery core. The cooler outdoor air fed into the indoor space contributes to reducing the cooling demand sustained by the system.

Dust suppression

An optional high efficiency filter may be used for up to 3,000 hours while maintaining a filtration efficiency (evaluated with colorimetric testing) of over 65%. The filter may also be fitted in the GUF unit after initial installation and takes up no additional precious space.

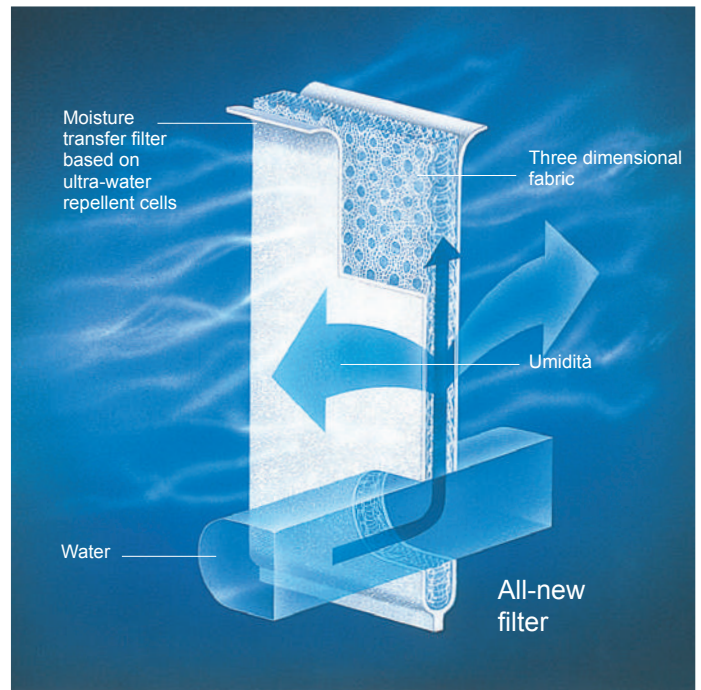

Automatic regulation

GUF ventilation and recovery units may be integrated into a Melans control and regulation system for Mitsubishi Electric air conditioner installations, as they use the same bus used for connecting indoor units.

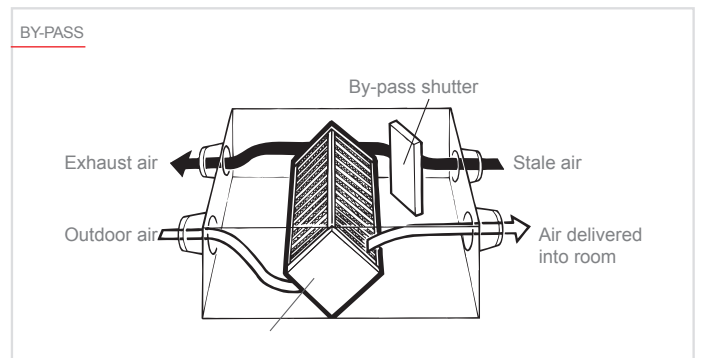

Advantages

- Reduced energy consumption
- Reduced thermal power necessary to treat outdoor air, equating to lower rated power
- Healthier environment
- Quieter operation (noise baffles in inlet and outlet)
- Free Cooling function using exclusively external air
- Humidification with film permeable to water vapour only
- Total air treatment (neutral air returned to outdoor environment)
- Custom temperature and humidity control
- Compact dimensions
- Installable in double ceilings with limited vertical space.

Flexible installation

The positions of air duct connections may be changed as needed to cater for different installation requirements.

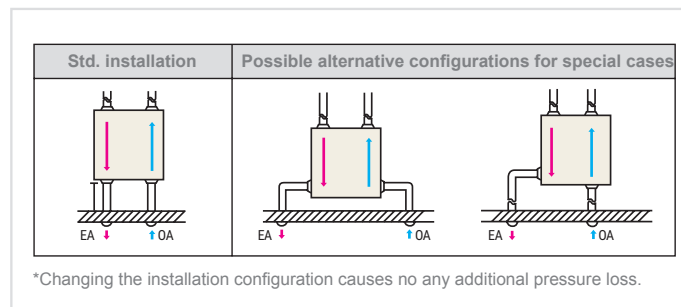

Technical specifications

MODEL			GUF-50RDH4		GUF-100RDH4		GUF-50RD4		GUF-100RD4		
Power supply	1-phase 220-240V 50Hz										
Communication system	In serie tramite rete M-NET: Mitsubishi Electric Air Conditioners Network System										
Lossnay	Mode	Air to Air Total heat recovery system									
	Material	Partition, Cross-flow structure, Special preserved paper-plate.									
Cooling capacity*1		kW	5,57	(1,94)	11,4	(4,12)	5,57	(1,94)	11,44	(4,12)	
	Power input	W	235-265		480-505		235-265		480-505		
	Current	A	1,15		2,2		1,15		2,2		
Heating capacity*1		kW	6,21	(2,04)	12,56	(4,26)	6,21	(2,04)	12,56	(4,26)	
	Power input	W	235-265		480-505		235-265		480-505		
	Current	A	1,15		2,2		1,15		2,2		
Temperature heat recovery efficiency		%	77,5/80		79,5/81,5		77,5/80		79,5/81,5		
Total heat recovery efficiency*2	Heating	%	68/71		71/74		68/71		71/74		
	Cooling	%	65/67		69/71		65/67		69/71		
Capacity index			P32		P63		P32		P63		
Humidifier capacity		kg/h	2,7		5,4		-		-		
Fan	Type x qty	SA: Centrifugal fan (Sirocco FAN) x 1 - EA: Centrifugal fan (Sirocco FAN) x 1									
	Static pressure	Pa	125		135		140		140		
		mmH ₂	12,7		13,8		14,3		14,3		
	Motor	Totally enclosed capacitor permanent split-phase induction motor, 4 poles, 2 units									
Flow rate (High speed)	m ³ /h	500		1000		500		1000			
	L/s	139		278		139		278			
SPL (Low-High)		dB(A)	33,5-34,5		38-39		33,5-34,5		38-39		
Ref. Piping diameter	Liquid	mm(in.)	Ø6,35(Ø1/4)		Ø9,52(Ø3/8)		Ø6,35(Ø1/4)		Ø9,52(Ø3/8)		
	Gas	mm(in.)	Ø12,7(Ø1/2)		Ø15,88(Ø5/8)		Ø12,7(Ø1/2)		Ø15,88(Ø5/8)		

*1 () value from Lossnay heat recovery.

*2 High/Low speed values.

s-AIRME NEW

OUTDOOR AIR HANDLING UNITS

ME-series



Connettività BMS	Accessory
Modbus	Contact sales network
Bacnet	Contact sales network
Wi-Fi connectivity	
KIPLink	
Supervisor System	
B.EYELink	
Standard filter (included with unit)	Optional filter
SUPPLY: G4+F7 (Coarse 55% + ePM1 50%)	F8 (ePM1 70%) F9 (ePM1 85%) Electronic filter
RETURN: G4 (Coarse 55%)	Active photocatalytic filter Active carbon filter H14 absolute filter

R32

R410A

SIZE	
s-AIRME 3000	3000 m ³ /h @ 300 Pa (optional 500 Pa)
s-AIRME 5000	5000 m ³ /h @ 300 Pa (optional 500 Pa)
s-AIRME 7500	7500 m ³ /h @ 300 Pa (optional 500 Pa)
s-AIRME 10000	10000 m ³ /h @ 300 Pa (optional 500 Pa)
s-AIRME 12500	12500 m ³ /h @ 300 Pa (optional 500 Pa)
s-AIRME 15000	15000 m ³ /h @ 300 Pa (optional 500 Pa)
s-AIRME 20000	20000 m ³ /h @ 300 Pa (optional 500 Pa)

Ideal for...

s-AIRME units are reversible, preconfigured and modular air handling units produced by **Mitsubishi Electric**. These units are designed and built for the complete treatment of outdoor fresh air for air renewal, recirculated air, or a combination of the two, to serve medium volume indoor spaces such as stores, small supermarkets, cinemas, theatres, logistics centres and expo centres.

Suitable for both **indoor** and **outdoor** installation, in compliance with the requirements of the standard UNI EN 378.

All s-AIRME models are fully compatible for installation in conjunction with Mitsubishi Electric Mr. Slim direct expansion outdoor units, and are **equipped with a direct expansion coil** with one or more interconnected gas circuits operating with R32 or R410A refrigerant gas, and EC plug-fans.

s-AIRME units are available in 7 sizes covering a range of delivery rates from **1,000 to 20,000 m³/h**. These machines are available in a choice of 3 configurations to cater for specific project needs (**AR** All Recirculation, **MF** Mixing and Free Cooling, and **HR/P** Plate Heat Exchanger), and 3 different basic power variants (**C** Basic, **I** Intermediate and **B** Boosted).

Perfectly compatible with direct expansion systems

s-AIRME units are fully compatible for installation together with both R32 and R410A variants of the Mitsubishi Electric Mr. Slim range of outdoor direct expansion units, for the seamless and efficient management of even the most complex installations with multiple outdoor units.

This range of air handling units is usable in conjunction with both Mr. Slim Standard Inverter and - for even greater efficiency and a broader range of operation - Mr. Slim Power Inverter units.

A WIDE RANGE OF POWER RATINGS

Partial or full air treatment
7 sizes and 3 power variants: **Basic (C)**, **Intermediate (I)** and **Boosted (B)**
2 refrigerant gases: **R32** and **R410A**



s-AIRME AR
All recirculation
Air flow rate from 1,000 to 20,000 m³/h
Cooling capacity from 10 to 125 kW



s-AIRME MF
Mixing & Free Cooling
Air flow rate from 1,000 to 20,000 m³/h
Cooling capacity from 10 to 125 kW



s-AIRME HR/P
Plate heat exchanger
Air flow rate from 2,000 to 15,000 m³/h
Cooling capacity from 20 to 150 kW

s-AIRME UNIT

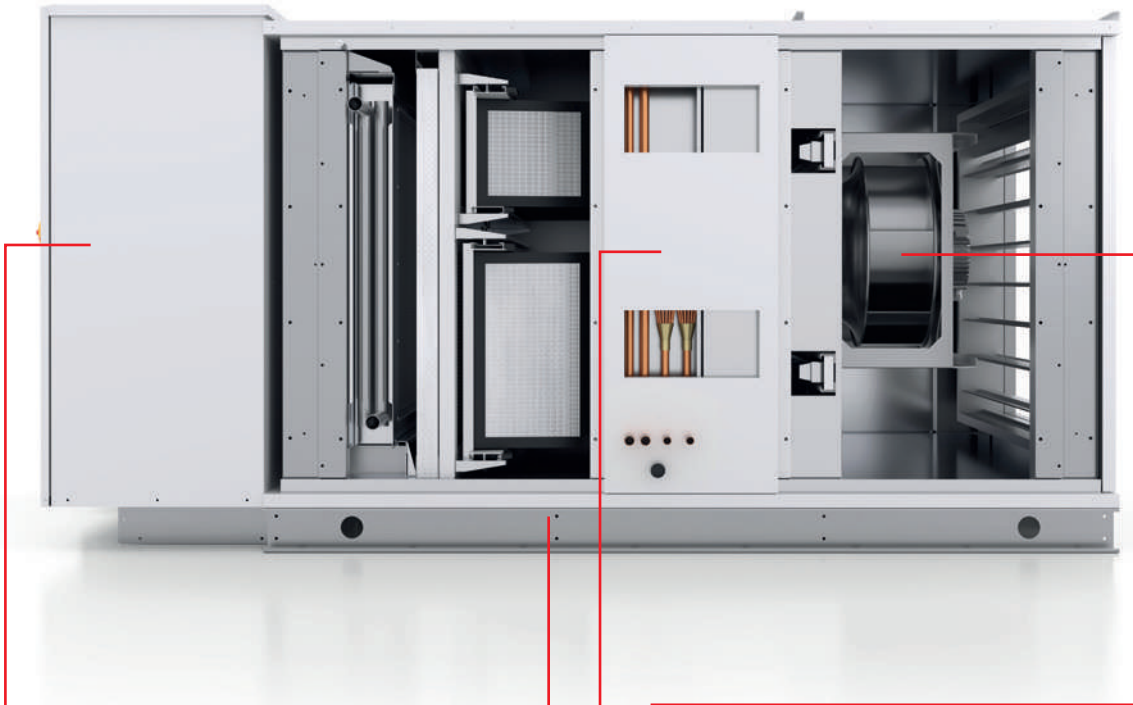

CONTROL PANEL

The s-AIRME unit is a **Plug&Play** solution equipped with the **AIR 3000+ controller system**, which takes advantage of the potential of the full inverter technology of Mr. Slim units to offer complete control over both ventilation and heating-cooling functions. The integrated ventilation system for the electrical panel ensures effective protection against overheating, the risk of pooling refrigerant gas and condensation forming on electrical components.

VENTILATION SECTION OF HANDLING UNIT

Plug-fan supply fan unit with **EC brushless IP54 direct drive motor**:

- continuous, precise air flow rate control without using an external inverter.
- available as two variants: standard, with 300Pa overpressure, and optional high output version with effective static overpressure of 500Pa. Both variants are optimised for superlative efficiency and low noise.
- The fan units installed are rated safe for operation in applications with A2L refrigerant gas.

STRUCTURE

Load-bearing **monobloc structure** with no pressed aluminium chassis elements, constructed from sandwich panels:

- thickness **60 mm**
- built-in thermal break
- outer panels with factory-applied paint finish for complete weather protection
- galvanised steel inner panel.
- thermal and acoustic insulation in expanded polyurethane foam (or optional mineral wool)
- polypropylene seal beading ensures continuous Class L1 seat tightness in accordance with EN 1886

This solution completely **eliminates all thermal bridges** forming across the aluminium profiles of a conventional structure with pressed chassis profile elements and panels, offering a drastically lower thermal bridging factor and improving the overall performance of the unit. The brackets and subframes supporting the internal components, and the load-bearing base of the unit, are fabricated in galvanised steel.

SAFETY DEVICE FOR OPERATION WITH A2L GAS

As R32 refrigerant gas is classified as an A2L refrigerant (mildly flammable) by the standard ISO 817, all s-AIRME units intended for use with this gas **are equipped with a gas detector sensor safety device**, which prevents the possibility of potentially dangerous concentrations of refrigerant gas accumulating in the space served or inside the unit itself in the event of leakage. For complete safety, R32 versions of s-AIRME units can also be equipped with optional safety dampers. Rated Class 4 devices according to the standard EN 751, and installed on both the air supply outlet and return inlet of the unit, these dampers isolate the space served from the unit if any escaping refrigerant gas is detected. For more effective evacuation of refrigerant gas, the supply damper is equipped with a rotating louvre vane which opens outwards when the unit is not operating, while the remaining vanes remain in the closed position. By shutting the last rotating vane in the array, this accessory ensures that the supply flow of the unit is ducted into the atmosphere.

DIRECT EXPANSION COIL

The expansion coil is designed with the optimal geometry defined by Mitsubishi Electric to ensure the ideal balance between rated thermal power and treated air flow rate, and complete compatibility with the outdoor units of the Mr. Slim range. The coil is also designed to be compatible with both R32 and R410A refrigerant gas types.

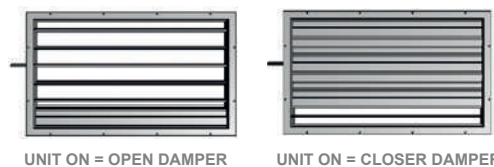

Control and Supervision Functions

Precise, efficient control

AIR 3000 + is a dedicated controller software system for both ventilation and temperature control, with advanced functions and proprietary adjustment features.

This controller can be used to manage the following functions and settings:

- unit power **on/off**
- **set manual or automatic operating mode** (heat or cool)
- ventilation, temperature and humidity set points
- **force 100% fresh outdoor air mode** (not for basic AR function)
- **force all recirculation mode**
- **automatic free-cooling and enthalpic free-cooling mode management** (not for basic AR function)
- set ventilation section mode to **constant flow** (standard), **constant pressure** (optional) or **variable flow** rate dependent on signal received from a CO₂ sensor (optional). Two different variable flow rate modes are available: modulated, or stepped with 2 levels (max. flow rate or min. flow rate)
- **automatic management of optional thermal modules** (hot water coil, electric heating element)
- **automatic modulation of proportion of fresh air for renewal** in relation to ppm CO₂ detected by dedicated sensor installed in the recirculation inlet duct of the unit or directly in the served zone (optional).

There are a number of options for setting up the architecture of the supervisor system: using either proprietary devices, or using BACnet, BACnet over-IP, Modbus, Modbus over-IP and Echelon protocols to integrate it into a third party system.

IMOUC: Intelligent Multiple Outdoor Units Control

s-AIRME can use the IMOUC (Intelligent Multiple Outdoor Units Control) protocol developed internally by Mitsubishi Electric, which offers the following capabilities and advantages:

- simultaneously connect and **manage up to 6 Mr. Slim** units, even with different power ratings;
- **maximise efficiency** by distributing thermal load over the individual Mr. Slim units, prioritising the units operating in the most favourable conditions;
- **modulate the thermal power of the system to as low as 20% of the overall rated thermal power**, which would not be possible if each Mr. Slim unit were to operate independently;
- **redistribute operating hours** uniformly and more efficiently between the outdoor units connected to the system;
- optimise **defrost** cycles, staggering start and stop times between the different Mr. Slim units connected (never allowing all units to execute defrost cycles simultaneously);
- automatic **backup** management in case of malfunction of a Mr. Slim unit;
- **NIGHT PURGE** function, which forces units into Free Cooling mode at night, when permitted by external air conditions, to offer significant energy savings.

BMS connectivity

There are a number of options for setting up the architecture of the supervisor system: using either proprietary devices, or integrating it into a third party system with the following protocols:

- BACnet/BACnet over-IP
- Modbus/Modbus over-IP
- Echelon.

KIPLink: the Keyboard in your Pocket

AIR 3000 + can also be configured with the innovative **KIPLink** optional user interface. Based on Wi-Fi technology, which also allows access to the unit from a LAN connection, this interface lets the user monitor and manage the settings of the unit directly from a smartphone or tablet by simply scanning the QR code on the unit itself.

KIPLink lets the user:

- switch the unit on and off;
- modify set points;
- monitor the status of the unit and the individual components of the system in detail;
- view/reset active alarms;
- view and download the data log

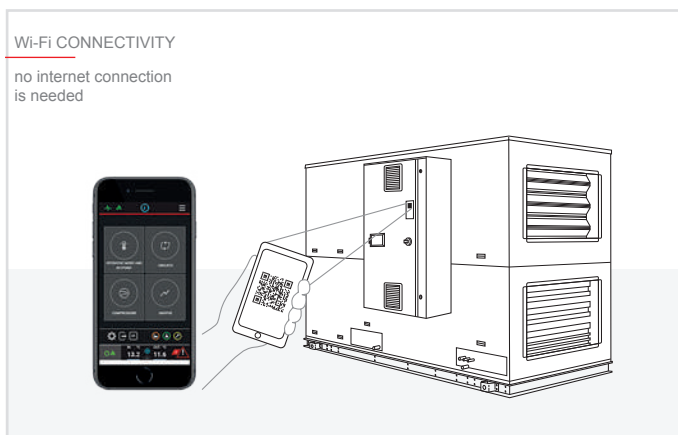

B.EYELink

B.EYELink is the new **supervisor system** for HVAC installations developed by Mitsubishi Electric. As the name itself implies ('B' for Building and 'EYE' for an overall vision of the system), this system offers total control over all the thermal management functions of Mitsubishi Electric, Climaveneta, RC and branded products.

The functions managed include:

- **Air conditioning** (air cooling and heating) and/or hot water production with VRF CITY MULTI systems;
- **Medium and high temperature water production** (for heating and DHW domestic hot water production) using heat pumps;
- **Ventilation and air renewal** with s-AIRME units and Rooftop systems.



Models and versions available

A solution which simplifies your installation while maximising versatility

s-AIRME units are extremely compact and ready to use, with all control, setting and safety components already factory-tested and installed in the respective sections.

Each application has its own specific needs and requires exactly the right solution. This is why the units of the s-AIRME range offer a wide choice of **configurations** to cater for the individual needs of each project and different thermal power requirements. Additionally, each machine configuration can be personalised even further with an extensive **selection of accessories**.

Versions

s-AIRME units are available in 7 sizes covering a range of delivery rates from 1,000 to 20,000 m³/h. Each size variant is available in a choice of 3 different thermal power versions:

- **Basic C version**, suitable for neutral air treatment. The performance and size characteristics of the direct expansion coil and the respective connection with a Mr. Slim unit are not intended to provide complete air conditioning treatment, but only to offer air recirculation and/or renewal capability.
- **Intermediate I version**, for air conditioning without dehumidification. The performance and size characteristics of the direct expansion coil and the respective connection with a Mr. Slim unit are adequate for providing an intermediate air conditioning treatment, but cannot sustain the additional latent heat load of a complete treatment inclusive of dehumidification;
- **Boosted B version**, for both conditioning and dehumidifying the treated air. The performance and size characteristics of the direct expansion coil and the respective connection with a Mr. Slim unit are sufficient for providing a complete air conditioning treatment, sustaining both the sensible heat and latent heat loads of a treatment inclusive of dehumidification.

AR configuration - All Recirculation

This is the basic unit configuration of the s-AIRME range. This unit is intended for operation in **all recirculation mode only**, in which air is drawn from the space served (yellow arrow) and then returned to the space after treatment by the direct expansion coil (blue arrow).

Other independent systems must be used to exhaust stale air from the space and renew the air with fresh outdoor air.

This is the ideal configuration for replacing obsolete units in an existing installation which already includes a dedicated unit for air renewal.



MF configuration - Mixing and Free Cooling

The main difference between this configuration and the basic unit is the addition of 2 opposed motorised dampers managed by the on-board controller for **switching between all-recirculation, mixed and free cooling operating modes**.

This configuration makes it possible to mix recirculated air drawn from the space served (yellow arrow) with a quantity of fresh outdoor air (red arrow). The proportion of fresh air used may either be a fixed value set by the controller, or variable in relation to the signal received from an optional air quality CO₂ sensor.

Free cooling mode is managed by the controller, which controls the aperture of the two dampers to obtain the most advantageous mixture of fresh air and recirculated air in relation to outdoor temperature, indoor temperature and set point. The thermal utilities connected to the unit are progressively disabled when in free cooling mode, and are disabled completely in case of total free cooling.

The supply fans ensure the rated inlet air flow of the system, while **other independent systems must be used to exhaust stale air**.

This mode is recommended where only small quantities of fresh air will be used for renewal, and for cases with limited loss of overpressure in the recirculation ducts and where the seal tightness of the building is poor (old buildings).



HR-P - Heat Recovery Plate configuration (return fan unit and plate heat exchanger recovery system)

The HR-P configuration uses a **plate heat exchanger to recover thermal energy** by transferring it as necessary between the outside air and recirculated air flows. The recovery unit is housed within the structure of the unit, together with the supply and return EC plug-fans, and situated ahead of the treatment coil.

This function is **suitable for new buildings with high air renewal rates** (such as cinemas, theatres, auditoriums, trade fair centres and shopping centres).

The thermodynamic principle of the function is as follows: the flow of fresh outside air (red arrow) passes through the plate heat exchanger, where it is heated or cooled (depending on the case) by the return air flow (yellow arrow). Seals between the aluminium plates keep the two air flows completely separate, and heat is transferred as a result of the temperature difference between them. As recovery efficiency increases with larger differences in temperature between the two air flows, this solution is particularly suitable for extreme climates.

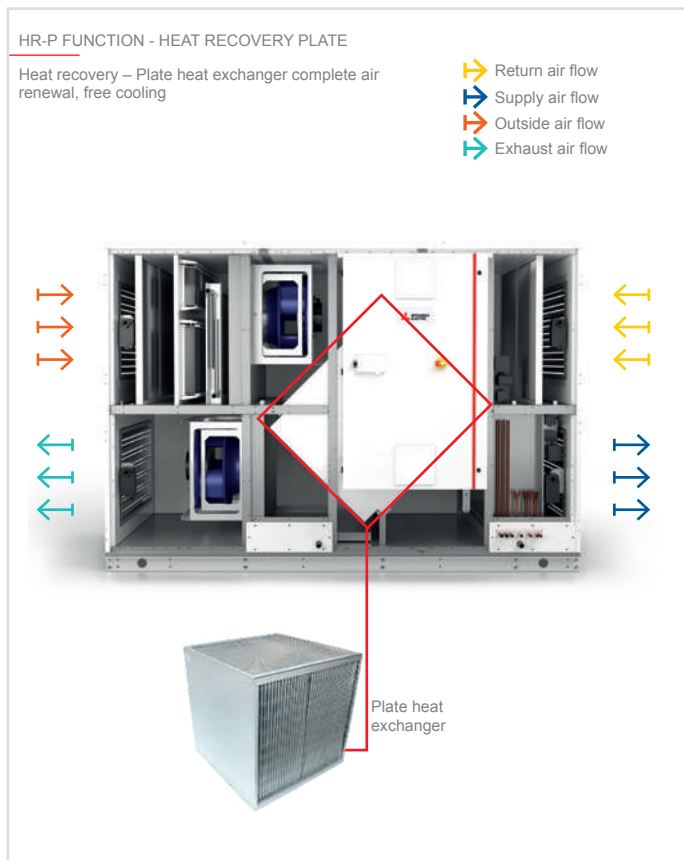

Advantages of the static heat recovery unit

- The exhaust and outside air flows are kept completely separate, with no risk of cross-contamination.
- Extremely reliable and safe operation;
- Easy to clean, and minimal maintenance;
- Excellent performance in extreme climates;
- Extends the operating range of the unit;
- Suitable for applications with high outside air flow rates;
- Aluminium heat exchanger plates for improved thermal exchange performance;
- Generous thermal exchange surface areas for minimised overpressure losses;
- In free-cooling mode, the bypass damper makes the return air bypass the heat recovery unit, reducing the power consumption of the return fan.

The operating principle of the unit in **free cooling** function is exactly the same as for the s-AIRME MF version. To implement this mode, **the unit is equipped with bypass dampers incorporated in the return air section of the plate heat recovery unit**, which prevent thermal exchange occurring within the heat exchanger between the return and fresh air flows when this is not advantageous.

Extended operating range

The **extended temperature range made possible by operating at partial load allows the s-AIRME to function with outdoor air temperatures as low as -20 °C**. The use of the optional electrical pre-heat coil is recommended for operation of the unit in heating mode at external temperatures below 5 °C.

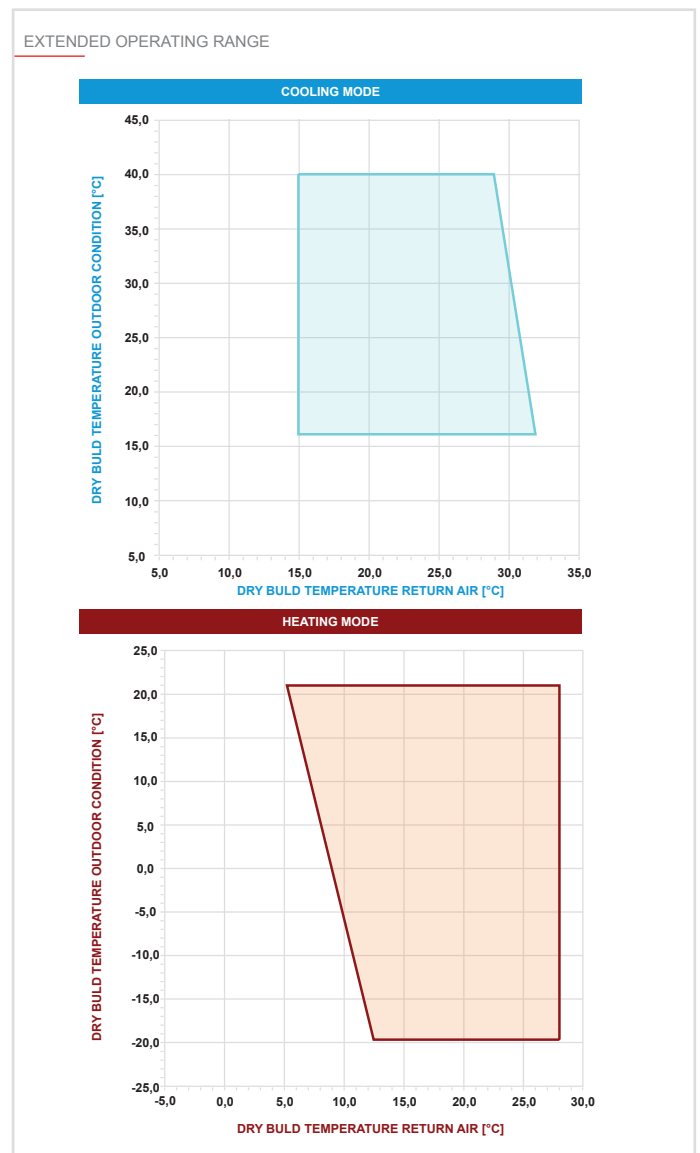

Construction Options

s-AIRME UNIT

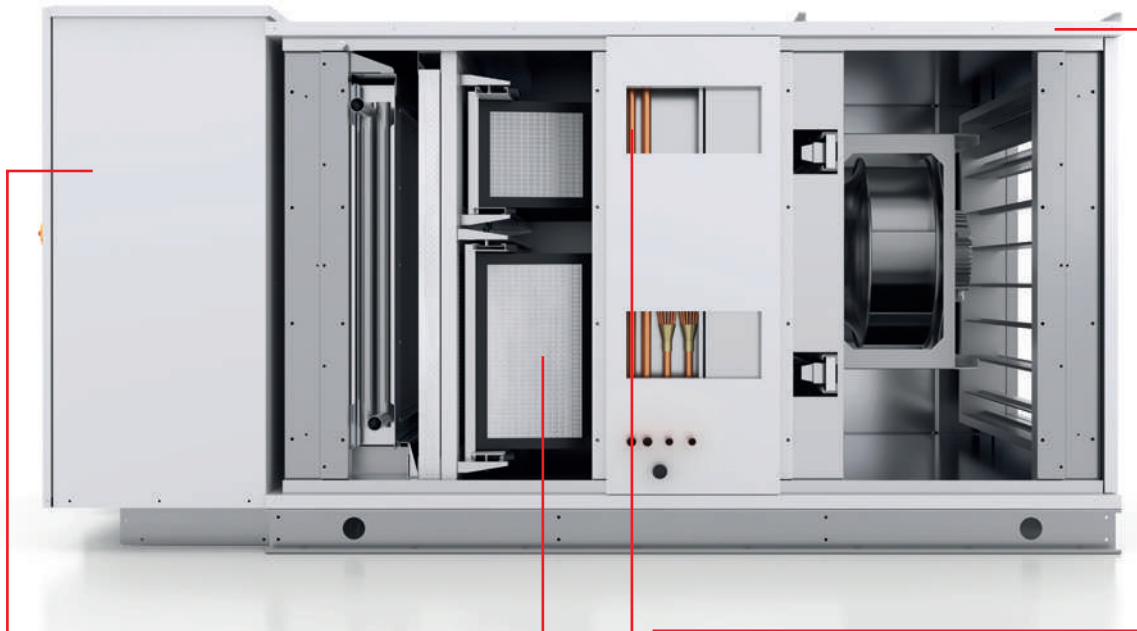

ELECTRICAL PANEL INCLUDED WITH UNIT/BMS

The 15,000 and 20,000 m³/h sizes of the AR and MF configurations, and the 12,500 and 15,000 m³/h sizes of the HR-P configuration, are shipped with the electrical panel dismantled from the unit to permit greater freedom for configuration, and to facilitate handling and installing the unit on site. Optional protocol boards: MODBUS / BACNET MS / TP RS485 / BACNET OVER IP / MOD-BUS TCP/IP

MONOBLOC UNIT WEATHER PROTECTION ROOF

In case of outdoor installations, the unit may be equipped with the optional aluminium roof offering protection against the weather.

FILTER SECTION

The unit comes complete with filters mounted on sliding steel rails allowing easy access for regular maintenance and replacement. In the standard configuration, the filter section consists of the following:

- supply outlet with ISO COARSE 55% + ePM01 50% prefilter (G4+F7 according to EN 779:2012)
- return inlet with ISO COARSE 55% prefilter (G4 according to EN 779:2012).

A wide choice of solutions related to IAQ (Indoor Air Quality) are available, and these units can also be equipped with optional filters offering higher filtration performance (see table below)

PROTECTIVE TREATMENTS FOR COIL

The unit is equipped with a copper-aluminium coil as standard.

However, the following alternatives are available as options:

- Copper-copper coil, with better corrosion resistance than the standard coil. Not susceptible to galvanic corrosion.
- FIN GUARD SILVER coil: excellent corrosion resistance in very harsh environments or coastal applications with exposure to salt.
- Coil with pre-painted fins: offers improved corrosion resistance in environments with moderate air pollution.
- Battery with Electrofin treatment: Excellent corrosion resistance in very harsh environments or coastal applications with exposure to salt.

	INDOOR AIR QUALITY - Optional solutions	
	DESCRIPTION	FUNCTION
PCO AIR PURIFICATION SYSTEM	Active purification system with photocatalytic oxidation. The combined action of a special UV light source and a honeycomb catalytic matrix generates a photocatalytic oxidation process.	This process releases hydroxyl radicals (-OH) and hydrogen peroxide (H ₂ O ₂), which are carried by the treated air flow and exert a continuous active sanitising effect on the surfaces in the space treated. This system is very effective in abating microbial load (bacteria, mould) and other contaminants such as allergens, unpleasant odours, organic and volatile compounds and ultra-fine particulate.
UVC LIGHT SOURCE	A purification system consisting of a UVC light source installed near the direct expansion coil, where condensate may promote the formation of a bacterial film.	The light source disinfects the irradiated surface, ensuring superior hygiene inside the machine.
ELECTRONIC FILTERS	These filters are an alternative to high efficiency mechanical pocket filters. This type of filter is based on the working principle of electrostatic precipitation.	It is suitable for applications where high filtration efficiency is required to eliminate pathogens and dust particles with diameters in the order of micrometers. The very limited overpressure loss of these filters reduces energy consumption for ventilation. The extended operating life and minimal maintenance needs of these filters allow the initial cost of installing them to be recouped over time.
ACTIVE CARBON FILTERS	Rigid active carbon pocket filters with a filtration efficiency of ePM01 50% (ISO 16890, F7 according to EN 779) with a deodorising action for use in conjunction with the standard pre-filters.	These offer finer filtration of the air delivered to the space served, combined with a complete deodorising action.
ABSOLUTE FILTERS	The standard high efficiency pocket filters can be supplemented with an add-on Class H14 HEPA polyhedral mini-pleat filtration module, consisting of a galvanised steel frame and glass fibre filter paper.	Installed after the air handling section, these filters exert an extremely fine filtration action on the air delivered to the space served. Suitable for healthcare sector applications.

UNITÀ S-AIRME

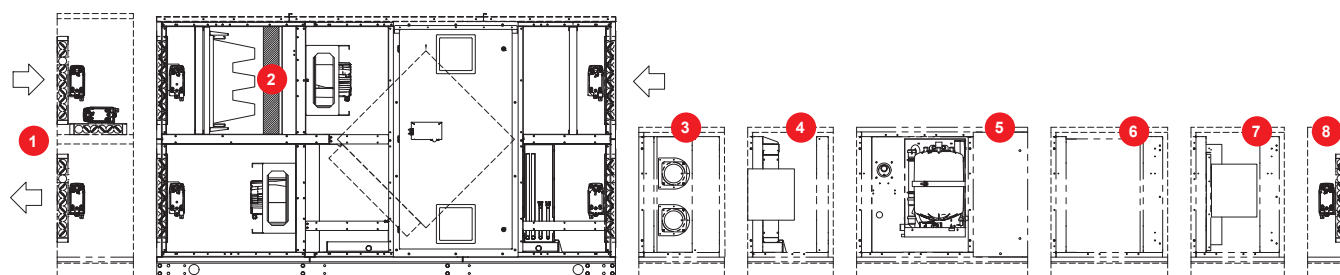

1 MIXING SECTION

For applications requiring the ability to recirculate a portion of the air extracted from the space served, the unit may be equipped with an additional accessory section with a motorised recirculation damper.

A number of different methods may be used to control the recirculation damper:

- **Using a CO₂ sensor, also available as an accessory.** If the CO₂ concentration in the extracted air exceeds the threshold set on the controller for the s-AIRME unit, the outdoor air inlet damper opens and the recirculation damper closes. When CO₂ concentration is below the set threshold, the recirculation damper is opened proportionally in relation to the level detected to reduce energy consumption.
- **Unit start in all recirculation mode.** The unit starts with the outdoor air inlet damper closed and the recirculation damper completely open. Once the set point conditions are met, the unit switches to all outdoor air operating mode.
- **Periodical air renewal:** the unit is forced to 100% outdoor air mode at precise intervals set on the controller.

2 PREHEAT COIL

Water or electric preheat coils may be installed ahead of the air handling coil. During winter operation, the preheat coil protects the heat recovery unit against exposure to excessively low temperatures. The unit controller system automatically activates the preheat coil if the outdoor air temperature drops below -10 °C to increase the air temperature by up to 5 °C. With an electric preheat coil, heating power is modulated by activating the three different stages of the coil itself. With a hot water coil, heating power is controlled by modulating the aperture of the 3-way valve feeding the coil.

These coils can also be used as supplementary heating during winter operation of the unit.

3 ACTIVE AIR PURIFICATION SYSTEM

s-AIRME units can be equipped with an active photocatalytic oxidation purification system. This system may be used to actively purify large volumes of air, eliminating a wide variety of contaminants that cannot always be captured by conventional static filters.

4 POST-HEAT COIL

Available as either water or electric versions, a post-heat coil may be used to supplement the direct expansion coil with additional heating power during winter operation of the unit, or to post-heat air after dehumidification during summer operation.

Electric coils feature three stage operation to allow finer temperature control, while the heating power of a hot water coil is controlled by modulating the aperture of a 3-way valve.

This coil can also be activated during the defrost cycle.

5 STEAM HUMIDIFIER SECTION

For applications requiring additional humidification of the air delivered to the space served, the unit may be equipped with a specific add-on humidifier accessory. The additional moisture is provided by an immersion electrode steam generator connected to a steam distributor manifold situated in the supply outlet. The quantity of steam generated and electrical power consumption of the steam generator are determined in relation to the specific size variant of the s-AIRME unit. Sensors measuring air humidity allow the controller of the s-AIRME to regulate the output of the steam generator via a 0-10V signal. Humidity control may be linked to the humidity measured in either the supply flow or the return flow. The section is designed and constructed to ensure quick and simple mechanical and electrical connection to the unit. When equipped with this accessory, the electrical panel of the s-AIRME is supplied complete with all the additional power and protection components needed for operation of the steam generator. The electrical power feed for the accessory is taken directly from the electrical panel of the s-AIRME unit.

The section includes a condensate collector tray which collects and drains the water condensing from the steam.

Alternatively, a digital ON/OFF signal provided by the unit may be used to control an external humidifier in relation to the reading of the humidity sensor situated in the return inlet.

6 SILENCERS

An add-on silencer module, with internal baffles and sound-absorbing mineral wool, may be installed to reduce the noise emissions of ventilation systems.

7 H14 ABSOLUTE FILTERS

The standard high efficiency pocket filters can be supplemented with an add-on Class H14 HEPA polyhedral mini-pleat filtration module, consisting of a galvanised steel frame and glass fibre filter paper.

These filters exert an extremely fine filtration action on the air delivered to the space served, making them suitable for healthcare sector applications.

8 OUTDOOR AIR, SUPPLY AIR, RETURN AIR AND EXHAUST AIR DAMPERS

For air distribution duct installations which require the air flow to be shut off when the unit is not running, dampers may be installed on the outdoor air inlet, the supply outlet to the space served, the return air inlet and the exhaust outlet venting into the external atmosphere as optional accessories. These dampers are supplied ready-installed on the unit, complete with servo-control mechanisms for aperture and closure. The supervisor and controller system of the unit controls the servo-mechanisms to open and close the dampers when requested by the management logic.

CO₂ SENSOR



The controller system of the s-AIRME may be supplemented with a CO₂ sensor. When a threshold for CO₂ concentration in the return air is set, the controller of the s-AIRME applies the following control strategies:

- **Two-step (min./max.) fan speed air flow modulation** (requires installation of accessory dual fan speed controller board): if the CO₂ concentration is below the threshold, the flow rate of the fans is set to the minimum value, whereas if the threshold is exceeded, the flow rate is automatically set to the maximum value.
- **Air flow modulation with accessory recirculation damper:** in this case, the fans always operate at a fixed flow rate, and the aperture or closure of the recirculation damper is modulated as described in the paragraph relative to the accessory MIXING SECTION.

WATER CONNECTION LOCATIONS

For greater configuration freedom and to facilitate on-site installation, s-AIRME units may be configured with direct expansion coil and hydronic coil connections and inspection hatches situated on different sides of the unit itself.

SMOKE DETECTOR

For greater safety, the unit may be equipped with an optional smoke detector which, if smoke is detected, forces the unit to shut down and stops the delivery of air to the indoor space served to reduce the potential risk of fire.

RAIN COWL AND MESH ON OUTDOOR AIR INLET

s-AIRME units may be equipped with a rain cowl complete with bird protection mesh installed on the outdoor air inlet, which prevents small objects or rain drops from being aspirated into the unit from outside by the incoming air flow.

Technical specifications AR CONFIGURATION			R410A						
SIZE VARIANT			3000	5000	7500	10000	12500	15000	20000
VERSION C									
Cooling (indoor + outdoor unit)	Cooling capacity	kW	10,40	20,10	25,10	40,70	45,10	50,20	75,10
	Sensible heat power	kW	8,39	15,30	21,60	30,30	36,80	42,50	61,70
	Total power consumption	kW	3,79	6,88	6,48	12,10	12,50	13,50	21,00
	EER	-	2,75	2,93	3,87	3,36	3,61	3,72	3,58
Heating (indoor + outdoor unit)	Thermal power	kW	11,30	22,50	27,10	44,90	49,40	54,20	81,10
	Total power consumption	kW	3,77	7,07	6,43	11,80	12,00	13,10	18,40
	COP	-	2,99	3,18	4,21	3,81	4,11	4,13	4,40
VERSION I									
Cooling (indoor + outdoor unit)	Cooling capacity	kW	14,10	25,10	40,40	50,10	60,40	75,30	100,00
	Sensible heat power	kW	10,50	18,60	29,90	39,00	45,90	55,10	78,20
	Total power consumption	kW	3,73	6,93	10,70	12,30	17,80	20,10	26,30
	EER	-	3,79	3,63	3,79	4,07	3,40	3,75	3,80
Heating (indoor + outdoor unit)	Thermal power	kW	16,00	27,00	44,80	54,40	67,20	81,20	108,00
	Total power consumption	kW	3,93	6,90	11,30	12,10	17,20	23,50	25,60
	COP	-	4,08	3,92	3,98	4,49	3,92	3,46	4,23
VERSION B									
Cooling (indoor + outdoor unit)	Cooling capacity	kW	20,10	34,00	50,30	60,30	80,00	100,00	125,00
	Sensible heat power	kW	13,80	23,20	34,50	45,00	56,40	68,70	88,70
	Total power consumption	kW	6,67	10,80	11,80	18,20	23,20	31,70	39,20
	EER	-	3,01	3,16	4,27	3,32	3,45	3,15	3,19
Heating (indoor + outdoor unit)	Thermal power	kW	22,4	38,4	54,2	67,2	89,6	108	135
	Total power consumption	kW	7,6	10,1	13	16,8	23,9	26,4	33,2
	COP	-	2,95	3,8	4,18	4	3,76	4,1	4,08

All values given for unit in following state:
 - Nominal operating conditions (SUMMER: 35°C/50% Outdoor air, 27°C/47% Ambient air; WINTER: 7°C/87% Outdoor air, 20°C/50% Ambient air)
 - Unit with no accessories and with clean filters

Technical specifications MF CONFIGURATION			R410A						
SIZE VARIANT			3000	5000	7500	10000	12500	15000	20000
VERSION C									
Cooling (indoor + outdoor unit)	Cooling capacity	kW	12,30	24,30	29,50	49,00	53,30	59,00	88,10
	Sensible heat power	kW	9,44	17,30	24,50	34,30	41,60	48,40	70,10
	Total power consumption	kW	3,92	7,07	6,70	12,50	13,00	14,00	21,70
	EER	-	3,15	3,44	4,40	3,92	4,11	4,22	4,06
Heating (indoor + outdoor unit)	Thermal power	kW	12,10	23,80	28,60	47,50	51,90	57,20	85,60
	Total power consumption	kW	3,25	6,10	5,42	10,00	10,20	11,10	15,50
	COP	-	3,72	3,90	5,28	4,75	5,08	5,15	5,53
VERSION I									
Cooling (indoor + outdoor unit)	Cooling capacity	kW	16,60	30,00	49,00	59,40	72,90	89,90	119,00
	Sensible heat power	kW	11,80	21,00	33,60	44,00	51,80	62,20	88,40
	Total power consumption	kW	3,88	7,18	11,00	12,80	18,30	20,90	27,40
	EER	-	4,29	4,18	4,44	4,64	3,98	4,30	4,33
Heating (indoor + outdoor unit)	Thermal power	kW	17,20	28,50	47,40	57,50	71,20	85,60	114,00
	Total power consumption	kW	3,35	5,87	9,53	10,00	14,60	19,40	21,20
	COP	-	5,12	4,86	4,98	5,73	4,89	4,41	5,39
VERSION B									
Cooling (indoor + outdoor unit)	Cooling capacity	kW	24,10	41,20	60,60	73,10	97,40	121,00	150,00
	Sensible heat power	kW	15,20	25,80	38,50	48,80	62,90	76,70	99,30
	Total power consumption	kW	6,93	11,20	12,30	18,80	24,00	33,20	41,00
	EER	-	3,48	3,68	4,93	3,89	4,05	3,63	3,67
Heating (indoor + outdoor unit)	Thermal power	kW	23,90	40,70	57,10	71,20	94,80	114,00	143,00
	Total power consumption	kW	6,33	8,59	10,70	14,20	20,10	21,90	27,40
	COP	-	3,78	4,74	5,33	5,02	4,73	5,21	5,22

All values given for unit in following state:
 - Nominal operating conditions (SUMMER: 35°C/50% Outdoor air, 27°C/47% Ambient air; WINTER: 7°C/87% Outdoor air, 20°C/50% Ambient air)
 - Unit with no accessories and with clean filters

Technical specifications HR-P CONFIGURATION

R410A

SIZE VARIANT			3000	5000	7500	10000	12500	15000
VERSION C								
Cooling (indoor + outdoor unit)	Cooling capacity	kW	25,90	42,10	59,80	84,60	105,00	119,00
	Sensible heat power	kW	16,40	27,30	38,70	52,80	67,20	74,20
	Total power consumption	kW	6,61	11,70	13,50	19,30	25,20	26,70
	EER	-	3,92	3,61	4,44	4,38	4,16	4,46
Heating (indoor + outdoor unit)	Thermal power	kW	32,00	52,60	74,00	104,00	130,00	150,00
	Total power consumption	kW	6,71	12,10	13,70	19,70	26,70	26,60
	COP	-	4,77	4,36	5,39	5,27	4,86	5,65
VERSION I								
Cooling (indoor + outdoor unit)	Cooling capacity	kW	31,00	49,60	74,70	99,50	124,00	148,00
	Sensible heat power	kW	17,10	29,90	44,80	59,90	70,10	89,30
	Total power consumption	kW	6,69	14,00	18,30	25,00	25,90	37,50
	EER	-	4,63	3,55	4,08	3,98	4,78	3,96
Heating (indoor + outdoor unit)	Thermal power	kW	37,00	60,60	91,60	122,00	149,00	186,00
	Total power consumption	kW	6,31	14,80	19,30	26,50	26,20	38,30
	COP	-	5,86	4,09	4,76	4,61	5,68	4,85
VERSION B								
Cooling (indoor + outdoor unit)	Cooling capacity	kW	33,80	59,40	84,20	119,00	148,00	178,00
	Sensible heat power	kW	19,20	32,60	48,20	62,60	77,90	93,80
	Total power consumption	kW	7,71	13,90	19,10	25,10	31,50	38,40
	EER	-	4,39	4,26	4,42	4,75	4,71	4,64
Heating (indoor + outdoor unit)	Thermal power	kW	41,70	70,20	101,00	140,00	175,00	213,00
	Total power consumption	kW	8,00	14,10	18,90	24,30	31,20	36,80
	COP	-	5,22	4,99	5,35	5,76	5,61	5,78

All values given for unit in following state:
 - Nominal operating conditions (SUMMER: 35°C/50% Outdoor air, 27°C/47% Ambient air; WINTER: 7°C/87% Outdoor air, 20°C/50% Ambient air)
 - Unit with no accessories and with clean filters

Technical specifications AR CONFIGURATION

R32

SIZE VARIANT			3000	5000	7500	10000	12500	15000	20000
VERSION C									
Cooling (indoor + outdoor unit)	Cooling capacity	kW	10,00	20,10	25,00	40,70	45,00	50,00	75,20
	Sensible heat power	kW	8,76	15,10	18,10	30,40	32,70	35,50	55,80
	Total power consumption	kW	3,72	6,73	6,47	11,90	12,50	13,30	18,90
	EER	-	2,70	2,98	3,86	3,42	3,62	3,77	3,97
Heating (indoor + outdoor unit)	Thermal power	kW	11,20	22,40	26,90	44,80	49,40	53,80	81,00
	Total power consumption	kW	3,74	6,48	6,07	11,50	11,60	12,20	17,50
	COP	-	3,00	3,46	4,42	3,89	4,27	4,40	4,62
VERSION I									
Cooling (indoor + outdoor unit)	Cooling capacity	kW	14,00	25,10	40,30	50,20	60,10	75,10	100,00
	Sensible heat power	kW	9,66	16,00	27,30	33,60	43,50	48,60	66,50
	Total power consumption	kW	3,60	6,75	10,60	12,00	17,60	18,40	24,20
	EER	-	3,90	3,72	3,79	4,16	3,41	4,08	4,13
Heating (indoor + outdoor unit)	Thermal power	kW	16,10	27,00	44,80	54,00	67,20	80,80	108,00
	Total power consumption	kW	3,66	6,18	11,20	11,50	16,40	21,80	25,30
	COP	-	4,41	4,38	4,02	4,69	4,09	3,71	4,27
VERSION B									
Cooling (indoor + outdoor unit)	Cooling capacity	kW	20,10	34,00	50,10	60,10	80,10	100,00	125,00
	Sensible heat power	kW	14,10	21,60	29,40	40,50	53,70	58,60	75,20
	Total power consumption	kW	6,64	9,72	11,60	17,10	22,70	28,30	35,60
	EER	-	3,03	3,50	4,30	3,51	3,52	3,54	3,51
Heating (indoor + outdoor unit)	Thermal power	kW	22,40	38,40	54,10	67,20	89,60	108,00	135,00
	Total power consumption	kW	7,48	9,75	12,40	16,40	22,30	26,10	32,20
	COP	-	3,00	3,94	4,37	4,10	4,03	4,14	4,19

All values given for unit in following state:
 - Nominal operating conditions (SUMMER: 35°C/50% Outdoor air, 27°C/47% Ambient air; WINTER: 7°C/87% Outdoor air, 20°C/50% Ambient air)
 - Unit with no accessories and with clean filters

Technical specifications MF CONFIGURATION			R32						
SIZE VARIANT			3000	5000	7500	10000	12500	15000	20000
VERSIONE C									
Cooling (indoor + outdoor unit)	Cooling capacity	kW	12,10	24,00	29,50	48,50	53,50	59,00	87,70
	Sensible heat power	kW	9,93	17,20	20,90	34,60	37,50	41,10	64,60
	Total power consumption	kW	3,77	6,76	6,49	12,00	12,50	13,30	19,00
	EER	-	3,21	3,55	4,54	4,05	4,27	4,43	4,62
Heating (indoor + outdoor unit)	Thermal power	kW	11,50	23,00	27,60	45,90	50,60	55,30	83,30
	Total power consumption	kW	3,09	5,37	4,92	9,28	9,40	9,95	14,10
	COP	-	3,71	4,27	5,61	4,94	5,38	5,56	5,92
VERSIONE I									
Cooling (indoor + outdoor unit)	Cooling capacity	kW	16,80	29,90	48,90	59,30	72,40	89,00	118,00
	Sensible heat power	kW	11,00	18,30	31,00	38,50	49,40	55,50	76,10
	Total power consumption	kW	3,62	6,77	10,70	12,10	17,70	18,40	24,30
	EER	-	4,64	4,42	4,57	4,91	4,09	4,83	4,87
Heating (indoor + outdoor unit)	Thermal power	kW	16,50	27,70	45,90	55,50	68,90	82,90	111,00
	Total power consumption	kW	2,99	5,10	8,93	9,11	13,10	17,30	19,90
	COP	-	5,53	5,44	5,13	6,09	5,24	4,8	5,56
VERSIONE B									
Cooling (indoor + outdoor unit)	Cooling capacity	kW	24,60	41,40	60,30	73,10	97,50	120,00	150,00
	Sensible heat power	kW	15,50	24,30	33,40	45,80	60,60	66,60	85,60
	Total power consumption	kW	6,69	9,76	11,70	17,20	22,90	28,40	35,80
	EER	-	3,68	4,24	5,16	4,25	4,26	4,24	4,20
Heating (indoor + outdoor unit)	Thermal power	kW	22,80	39,30	55,40	68,80	91,70	111,00	139,00
	Total power consumption	kW	6,10	7,97	9,76	13,10	17,80	20,60	25,30
	COP	-	3,75	4,93	5,68	5,27	5,16	5,37	5,48

All values given for unit in following state:
 - Nominal operating conditions (SUMMER: 35°C/50% Outdoor air, 27°C/47% Ambient air; WINTER: 7°C/87% Outdoor air, 20°C/50% Ambient air)
 - Unit with no accessories and with clean filters

Technical specifications HR-P CONFIGURATION			R32						
SIZE VARIANT			3000	5000	7500	10000	12500	15000	
VERSION C									
Cooling (indoor + outdoor unit)	Cooling capacity	kW	25,90	42,00	59,70	84,90	105,00	119,00	
	Sensible heat power	kW	15,80	26,30	35,90	50,20	64,70	71,60	
	Total power consumption	kW	6,62	11,60	13,60	19,20	25,70	26,30	
	EER	-	3,90	3,61	4,39	4,42	4,07	4,53	
Heating (indoor + outdoor unit)	Thermal power	kW	31,90	52,40	73,80	104,00	130,00	150,00	
	Total power consumption	kW	6,78	11,90	13,00	19,10	26,40	25,70	
	COP	-	4,71	4,39	5,68	5,46	4,91	5,85	
VERSION I									
Cooling (indoor + outdoor unit)	Cooling capacity	kW	30,80	49,50	75,00	99,50	124,00	148,00	
	Sensible heat power	kW	16,10	29,20	44,10	58,40	65,40	87,50	
	Total power consumption	kW	6,64	13,80	18,70	24,40	25,80	36,50	
	EER	-	4,64	3,59	4,01	4,08	4,81	4,07	
Heating (indoor + outdoor unit)	Thermal power	kW	36,80	60,70	91,90	122,00	148,00	186,00	
	Total power consumption	kW	6,17	14,30	19,10	25,50	24,80	38,00	
	COP	-	5,97	4,24	4,82	4,78	5,97	4,89	
VERSION B									
Cooling (indoor + outdoor unit)	Cooling capacity	kW	33,70	60,10	84,50	119,00	149,00	178,00	
	Sensible heat power	kW	18,20	29,60	43,80	58,80	73,90	88,50	
	Total power consumption	kW	7,57	13,90	18,70	24,40	31,00	36,70	
	EER	-	4,45	4,33	4,51	4,89	4,80	4,85	
Heating (indoor + outdoor unit)	Thermal power	kW	42,10	70,00	101,00	141,00	175,00	214,00	
	Total power consumption	kW	7,75	13,40	18,50	24,00	30,30	36,40	
	COP	-	5,44	5,22	5,45	5,87	5,77	5,87	

All values given for unit in following state:
 - Nominal operating conditions (SUMMER: 35°C/50% Outdoor air, 27°C/47% Ambient air; WINTER: 7°C/87% Outdoor air, 20°C/50% Ambient air)
 - Unit with no accessories and with clean filters

Control Systems

Remote control

PAC-YT52CRA Design Remote Control	278
PAR-41MAAB Deluxe Remote Control NEW	279
PAR-CT01MA Prisma Remote Control	280
PAR-U02MEDA Advanced Remote Control	282

Wireless remote control

PAR-FL32MA Wireless Remote Control	284
PAR-SL101A-E Wireless Remote Control	285

Remote control

PZ-62DR-EB Lossnay Remote Control	286
PAR-W21MAA / PAR W31MAA Ecodan Remote Control	288

Centralized control

AT-50B System Centralized Control	289
AE-200E 3D Touch Controller / Web Server Centralized Control	290
EW-50 3D Blind Controller / Web Server Centralized Control	293



Interface for hotel simplified application

MELCOTEL Integrated Solution for Hotels 294

Remote monitoring and control system

3D TABLET CONTROLLER Wi-Fi Remote Management System 300

MELCLOUD CITY MULTI

Cloud-based remote management and supervisor system 302

REMOTE MONITORING INTERFACE

Cloud Remote Management System 304

External signal integration

XML B.M.S. Interface for Ethernet Networks 306

ME-AC-MBS-100 Interface for Modbus® Networks and Interface for Knx® Networks **NEW** 307

BACnet® PIN CODE B.M.S. Interface for Bacnet® Networks 311



Control Systems



PAC-YT52CRA

DESIGN REMOTE CONTROL



NEW PAR-41MAAB

DELUXE REMOTE CONTROL



PAR-CT01MA

PRISMA REMOTE CONTROL



PAR-U02MEDA

ADVANCED REMOTE CONTROL



PAR-FL32MA

PAR-SL101A-E

WIRELESS REMOTE CONTROL



PZ-62DR-EB

LOSSNAY REMOTE CONTROL



PAR-W21MAA

PAR-W31MAA

ECODAN REMOTE CONTROL



AT-50B

SYSTEM CENTRALIZED CONTROL



AE-200E

3D TOUCH Controller
WEB SERVER CENTRALIZED
CONTROL



EW-50

3D BLIND Controller
WEB SERVER CENTRALIZED
CONTROL



3D TABLET CONTROLLER

WI-FI REMOTE MANAGEMENT
SYSTEM



MELCloud CITY MULTI

CLOUD REMOTE MANAGEMENT
SYSTEM



MELCOTEL

INTERFACE FOR HOTEL
SIMPLIFIED
APPLICATION



RMI

Remote Monitoring Interface
CLOUD REMOTE MANAGEMENT
SYSTEM



B.M.S. INTERFACE

B.M.S. INTEGRATION

PAC-YT52CRA

DESIGN REMOTE CONTROL



PAC-YT52CRA Design remote control

- Display with white backlighting.
- Simple wall-mounted installation.
- Easy and intuitive with icon-based interface.
- Operating mode selection function.
- Vane position selection function (for compatible indoor units).
- Usable to manage 1 group of up to 16 indoor units.
- Simple connection with single non-polarised two-core wire.
- **MA** self-addressing technology.

- Suitable for all types of indoor unit.
- Recommended for hotels and public spaces, as ambient air temperature display can be disabled.
- Integrated temperature sensor usable instead of indoor unit sensor.
- Configurable temperature range settable from local keypad.

Key Technologies



PAR-41MAAB

DELUXE REMOTE CONTROL UNIT



PAR-41MAAB Deluxe remote control unit

- Display with white (factory setting) or black backlighting and adjustable contrast.
- Simple wall-mounted installation.
- Night Set-back function for setting minimum winter temperature or maximum summer temperature in temperature maintenance mode.
- Effective static overpressure selection function for ducted indoor units (PEFY-P VMHS only).
- Internal weekly timer function and simplified internal timers (Auto-off, etc.).
- Usable to manage 1 group of up to 16 indoor units.
- Easy and intuitive, with icon based graphic interface, direct control buttons and function buttons.
- Simple connection with single non-polarised two-core wire.
- **MA** self-addressing technology.
- Suitable for all types of indoor unit, including GUF.
- Integrated temperature sensor usable instead of indoor unit sensor.
- Configurable temperature range settable from local keypad.
- **View and set setpoint temperatures in 0.5°C increments.**
- Supports 3D i-see sensor functions
- **14 languages available** (English, French, Spanish, German, Italian, Dutch, Portuguese, Greek, Russian, Czech, Turkish, Polish, Hungarian, Swedish).
- Draft reduction *
"Close" has been added to the manual vane angle selection.
The air outlet can be closed to reduce drafts from the air conditioner.

This remote control unit supports the R32 refrigerant leak detection system and requires the following operations to be configured:

Main: functions as a remote control unit and refrigerant leakage alarm for a single indoor unit.

Supervisor: monitors refrigerant leakage in the refrigeration system to which this remote control unit is connected. It is assumed that this function is used at a monitoring site and that the air conditioning units are not operable from the remote control unit.



Key Technologies

--	--	--	--	--	--	--	--	--	--

PAR-CT01MA

PRISMA REMOTE CONTROL



PAR-CT01MAA-SB



PAR-CT01MAA-PB

PAR-CT01MA prisma remote control

- Full color touch panel display
- 180 color patterns can be selected for control parameters or background on the display
- Easy wall mounted installation
- Night Set-back function for setting minimum winter temperature or maximum summer temperature in temperature maintenance mode.
- Effective static overpressure selection function for ducted indoor units (PEFY-P VMHS only).
- Internal weekly timer function and simplified internal timers (Auto-off, etc.).
- Usable to manage 1 group of up to 16 indoor units.
- Easy and intuitive, with icon based graphic interface, direct control buttons and function buttons.
- Simple connection with single non-polarised two-core wire.
- MA self-addressing technology.
- Suitable for all types of indoor unit, including GUF.
- Recommended for groups with only one indoor unit.
- Integrated temperature sensor usable instead of indoor unit sensor.
- Configurable temperature range settable from local keypad.
- **View and set setpoint temperatures in 0.5°C increments.**
- **Supports 3D i-see sensor functions for 60 x 60 PLFY-P VFM-E1 cassette and 90 x 90 PLFY-P(M) VEM-E cassette**

Multiple color pattern

180 MULTIPLE COLOR PATTERNS



Key Technologies

				
---	--	--	--	--

Multilingual support

The smartphone app can be displayed in the language that the guest's smartphone is set to.

Large color backlit touch display

New PRISMA remote control is equipped by 3.5 inch/HVGA Full Color LCD Touch screen,



Display customization

Customized display, color on parameter and background, editable parameter, logo image on the initial display.

Hotel setting

Simple operation panel is liked by users, especially in hotels. It is available to display only ON/OFF, set temp., fan speed.

Bluetooth connection

PAR-CT01MA remote control is equipped with Low Energy Bluetooth connection. Thanks to two dedicated Apps (one for installers and one for users) it is possible to connect your smartphone or tablet the the remote control. User App allows to control the air conditioning system connected to PAR-CT, with a simple and intuitive interface. Installer App allows to easily configure the remote control during maintenance and commissioning. Thanks to this App it is possible to save a settings pattern on mobile device and easily transfer it to the remote control, shortening service and commissioning timing.

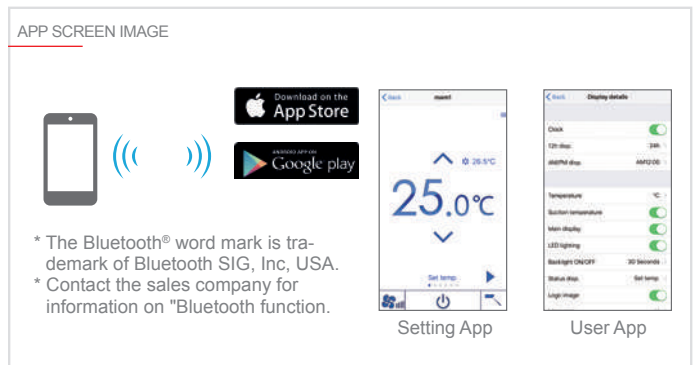

Logo image customization

Logo image can be displayed on the initial screen.

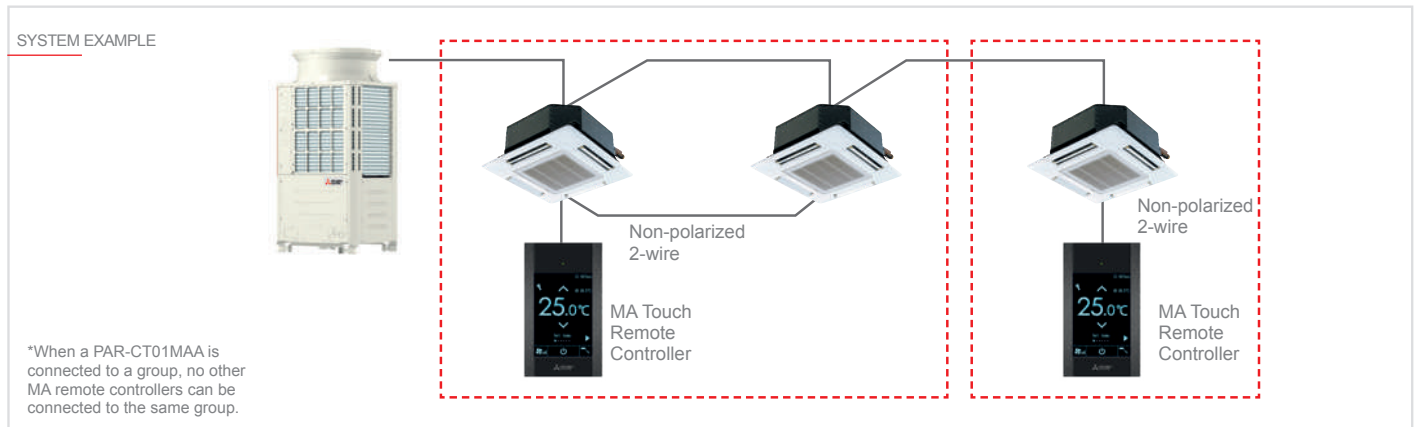

PAR-U02MEDA

ADVANCED REMOTE CONTROL



PAR-U02MEDA advanced remote control

The Mitsubishi Electric Advanced remote control may be used to control up to 16 indoor units. While advanced, this controller also offers basic functions such as monitoring and controlling the status of the units in the system, and a weekly hour timer. Four integrated sensors (temperature, humidity, occupancy and light) allow a series of advanced adjustment and control functions. For example, the occupancy sensor can be used to save energy by configuring different modes based on the occupied/vacant status of each room.

- Large monochrome LCD touch screen display with white backlighting.
- Usable to manage 1 group of up to 16 indoor units.
- **Integrated temperature, humidity, occupancy and light sensors.**
- SMART energy saving and comfort functions.

- Contextual colour LED indicating operating status of indoor units.
- **View and set setpoint temperatures in 0.5°C increments**
- **Dual Setpoint** function.
- Internal weekly timer.
- **ME M-Net** addressing technology.
- Extended setting ranges for setpoints (Cool: 19-35°C; Heat: 5-28°C).
- New functions for use in conjunction with AHC Programmable Controller (PLC M-Net), for creating operating strategies with generic devices.

Key Technologies

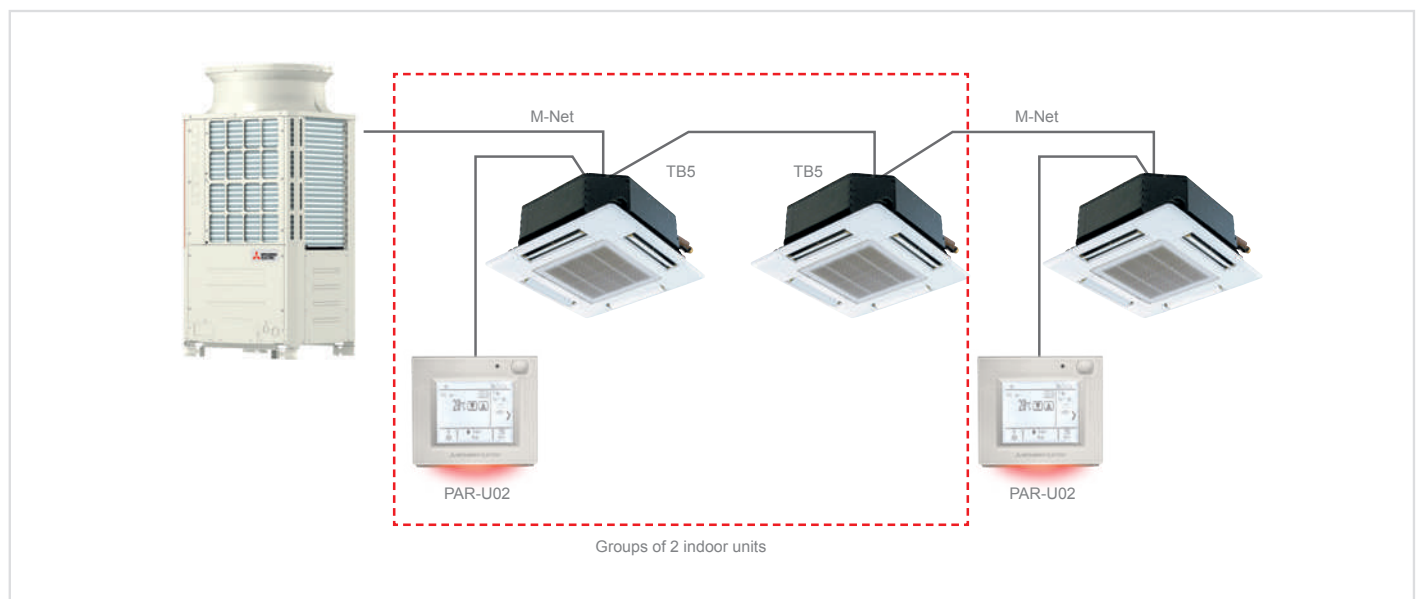

Occupancy sensor

The occupancy sensor detects if a room is vacant and enables automatic control of the indoor units to implement energy saving strategies based on the effective occupancy of each room. The occupancy sensor enables the following energy saving functions:

- Switch indoor units ON/OFF based on occupied/vacant state of room;
- Fan speed control;
- Switch indoor unit from Thermo ON to Thermo OFF state;
- Configure temperature deviation based on occupied/vacant status.

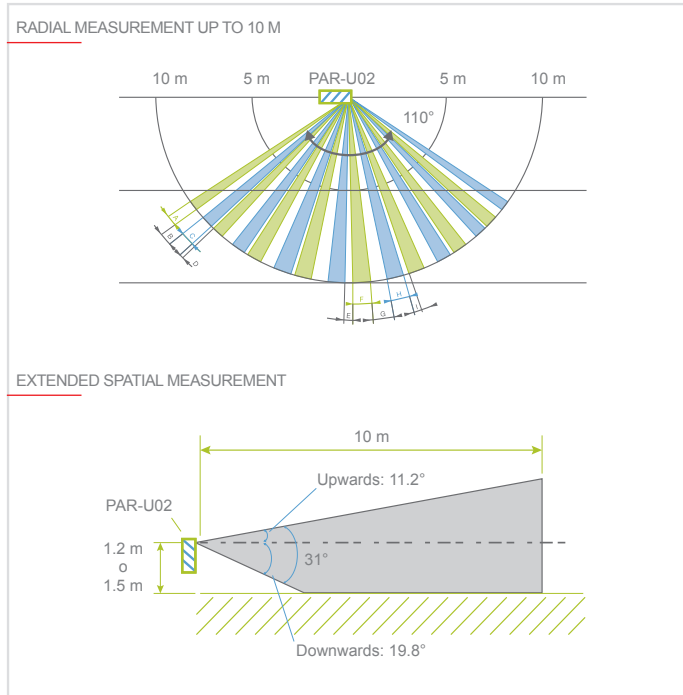

Light sensor

The light sensor measures the light levels in the conditioned room and adjusts the brightness of the remote control display accordingly. Bright/dark thresholds may be set directly from the remote control over an extended luminosity range (1 to 65535 lx). The light sensor is also used in low light conditions to confirm the occupied/vacant status of the room.

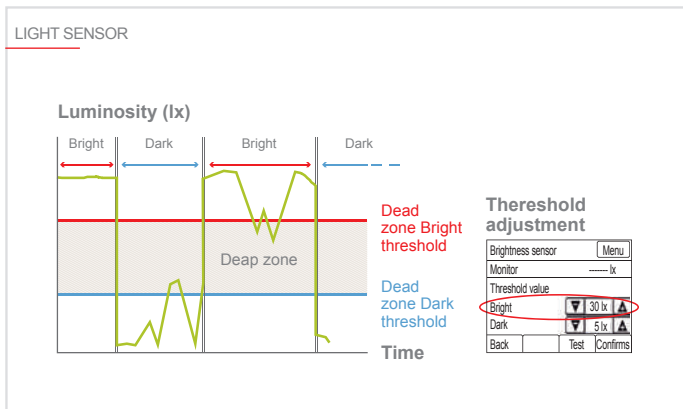

Temperature and humidity sensor

The integrated temperature and humidity sensor may be used to increase perceived comfort levels, while the ability to adjust the temperature with a precision of 0.5°C gives the user an even greater sense of control. The relative humidity sensor, combined with the ability to interlock the remote control with a programmable AHC controller, makes it possible to control humidity with external devices connected to the system via the AHC.

LED status indicator

The LED status indicator indicates the status of active functions on the remote control. Each colour is associated with a status or function: e.g. Red=Heating, Blue=Cooling etc. The LED indicator may be temporarily or permanently disabled.

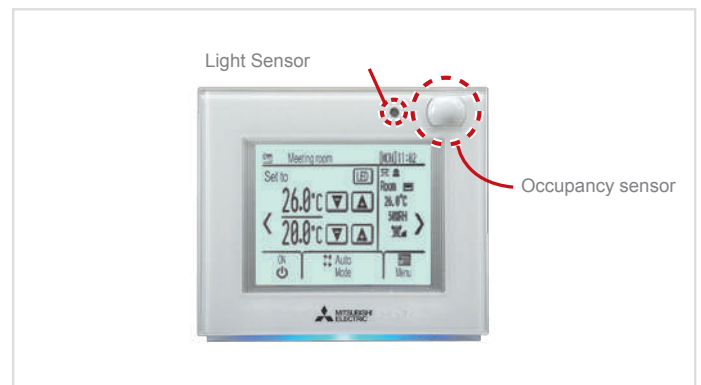
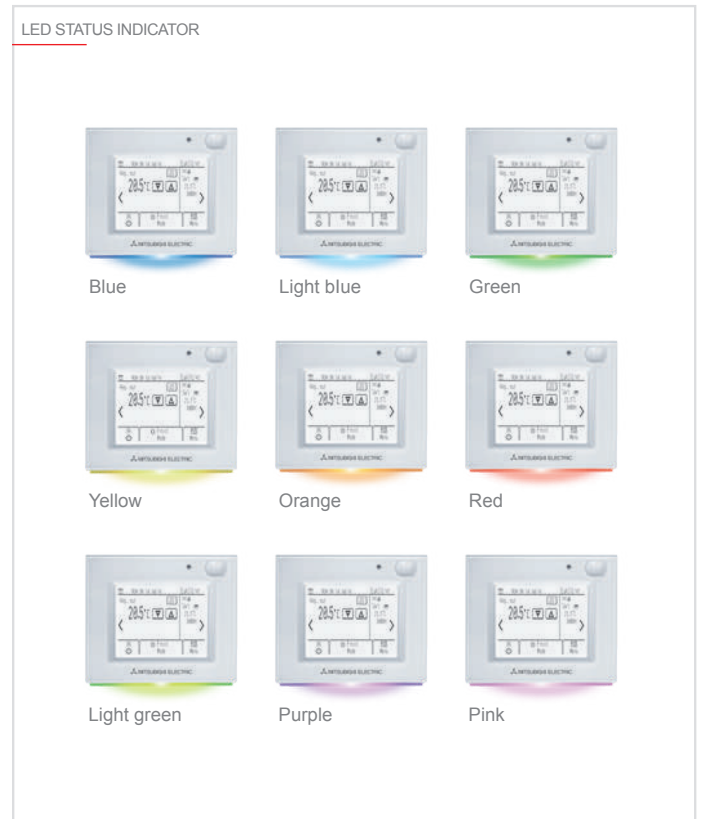

PAR-FL32MA

WIRELESS REMOTE CONTROL



PAR-FL32MA wireless remote control

- Usable to manage 1 group of up to 16 indoor units.
- Easy and intuitive with icon-based interface.
- Receiver connected simply with single non-polarised two-core wire.
- MA self-addressing technology.
- Suitable for all types of indoor unit.
- Recommended for groups with only one indoor unit.
- Generic receiver for all indoor unit types: PAR-FA32MA.
- Specific corner receiver for 4-way PLFY-P(M) VEM-E cassette units: PAR-SE9FA.

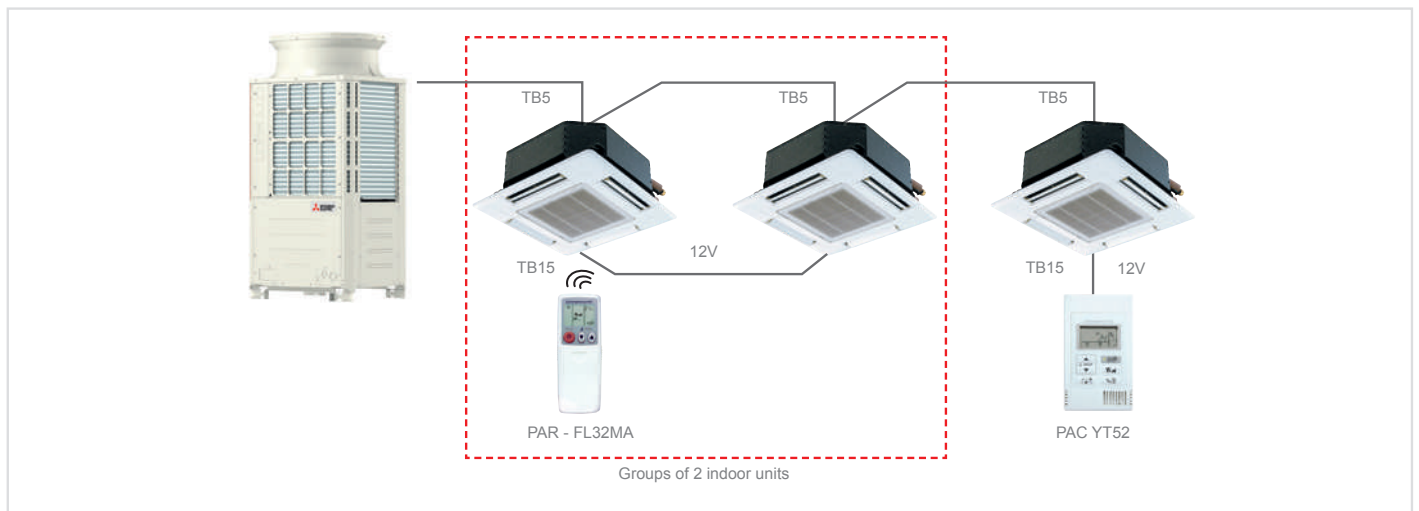

Compatibility table		
	Wireless signal receiver	Wireless remote control
PMFY-P VBM PLFY-P VLMD PEFY-P VMR/VMH PEFY-P VMS1 PEFY-M VMA PEFY-P VMA3 PEFY-P VMHS PFFY-P VLEM/VKM/VCM PCFY-P*VKM	PAR-FA32MA	PAR-FL32MA
PLFY-P/M VEM PLFY-P VFM-E1	PAR-FA32MA	PAR-FL32MA

Compatibility table		
	Wireless signal receiver	Wireless remote control
PKFY-P VLM PKFY-P VKM	Built in	PAR-FL32MA

PAR-SL101A-E

WIRELESS REMOTE CONTROL



Wireless remote control PAR-SL101A-E

- Compatible with PLFY-VFM and PLFY-VEM
- **Backlighting**
- Group with up to 16 units
- **Direct/Indirect function** with corner PAC-SF1ME-E (3D i-see sensor)
- **Single vane control**
- Temperature view and setting 0,5°C
- **3D i-see sensor compatible**

Key Technologies

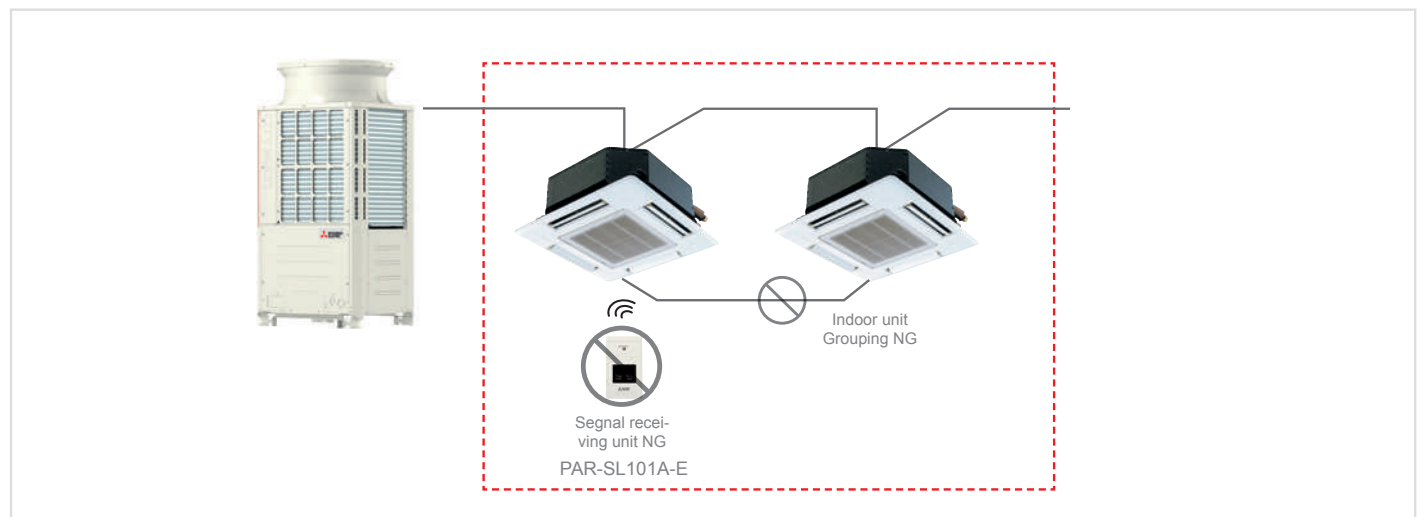

Compatibility table

	Wireless signal receiver	Wireless remote control
PLFY-P/M VEM-E	PAR-SE9FA-E	PAR-SL101A-E
PLFY-P*VFM-E1	SLP-2FAL	

PZ-62DR-EB

LOSSNAY REMOTE CONTROL



PZ-62DR-EB remote control for Lossnay

- Specific remote control for Lossnay heat recovery units.
- Usable to manage one group of up to 15 Lossnay units.
- Easy and intuitive with icon-based interface.
- Simple connection with single non-polarised two-core wire.
- Internal weekly timer.
- Custom ventilation strategies for mode switching (Auto/recovery/bypass).
- Night purge function for active night-time ventilation in summer.
- On-display service messages.

- Backlit LCD screen.
- Energy management

3 Languages are added
Greek, Slovenian, Denmark

Compatibility
PZ-62DR-EB are compatible with both RVX and RVS.

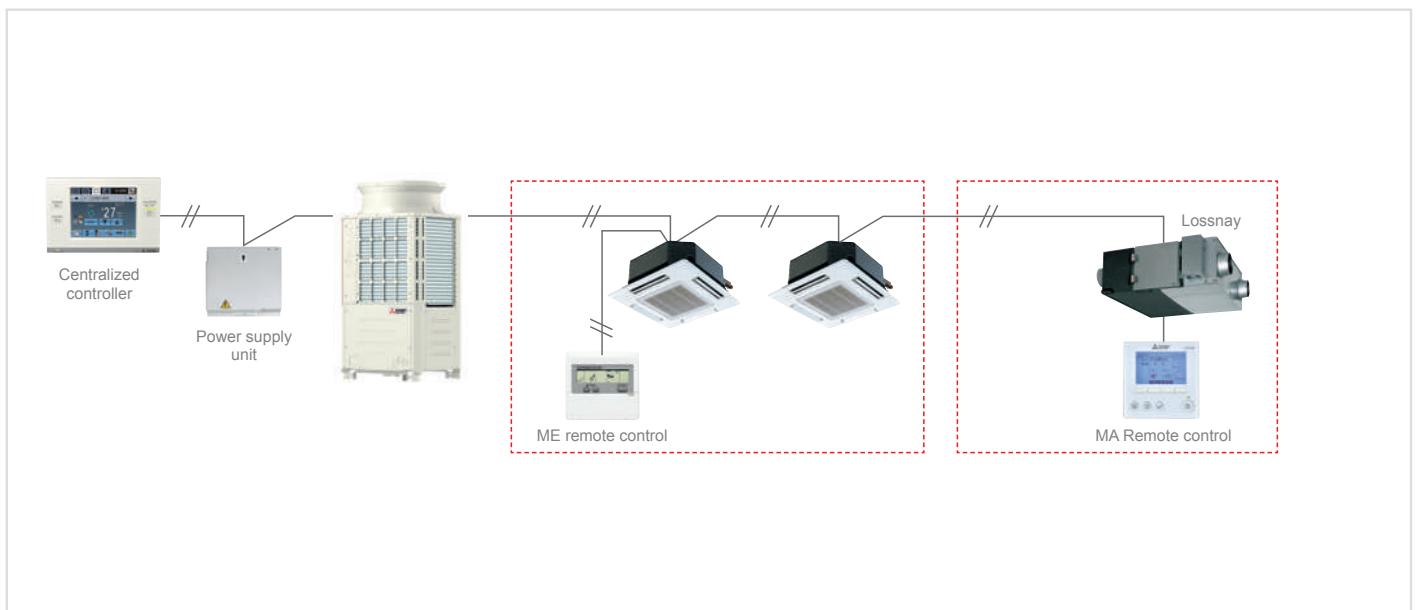

*Not compatible with LGF

Dedicated PZ-62DR-EB wired controller

The new PZ-62DR-EB controller can be used to control all the functions of the LGH-RVS unit.

If the PZ-70CSW-E (optional) or PZ-70CSB-E (optional) CO₂ sensor is used, the carbon dioxide concentration in the room can be displayed on the control unit's display.

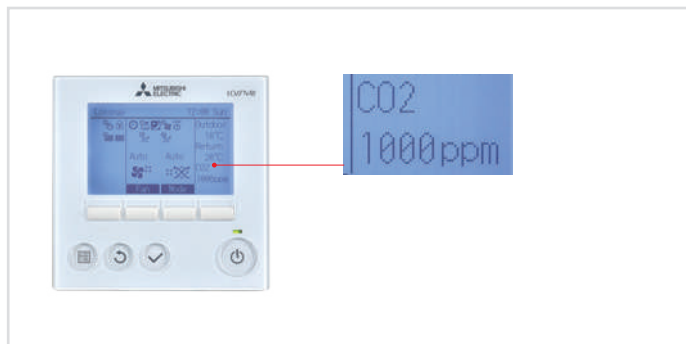

Function	PZ-62DR-E
Fan speed selection	4 fan speeds and Auto (Auto is available when using a CO2 sensor)
Control with a CO2 sensor	Yes (Fan speed automatically changes from 25% to 100% depending on the CO2 concentration*)
Ventilation mode selection	Energy recovery/Bypass/Auto
Night-purge	Yes
Function setting from remote controller	Yes
Bypass temp. free setting	Yes
Multi-stage air flow control	Yes (Both supply and exhaust fan speeds can be set separately from 25% to 100% in 5% pitches)
ON/OFF timer	Yes
Auto-off timer	Yes
Weekly timer	Yes
Fan speed timer	Yes
Operation restrictions (ON/OFF, ventilation mode, fan speed)	Yes
Operation restrictions (fan speed skip setting)	Yes
Screen contrast adjustment	Yes
Language selection	Yes
CO2 concentration indication	Yes (available when using a CO2 sensor)
Filter cleaning sign	Yes (maintenance interval can be changed)
Error indication	Yes (displays model name, serial number, contact information if they are input)
Error history	Yes
OA/RA/SA temp. display	Yes

*When using a CO₂ sensor. Upper and lower limits may be changed.

PAR-W21MAA / PAR-W31MAA

ECODAN REMOTE CONTROL



PAR-W21MAA / PAR-W31MAA remote control for hydronic modules and HWHP units / E-SERIES

- (PAR-W21MAA) Remote control for hydronic modules, HWS and ATW units and Hot Water Heat Pump package systems (HWHP) CAHV&CRHV.
- Usable to manage 1 group of up to 16 indoor units.
- Easy and intuitive with icon-based interface.

- Simple connection with single non-polarised two-core wire.
- MA self-addressing technology.
- Operating mode selection (Heating, Heating ECO, Hot water, etc.).
- Internal weekly timer.
- Customisable water temperature ranges for switching operating mode from local keypad.
- On-display service messages.
- PAR-W31MAA specific for E-SERIES



AT-50B

SYSTEM CONTROLLER



AT-50B system controller

- 5" backlit LCD touch screen.
- Usable to manage 50 groups of up to 50 indoor units.
- Individual or collective group control, with groups displayed in grid, list or group format.
- **Dual-Setpoint** function.
- **View and set setpoint temperatures in 0.5°C increments.**
- Two weekly timers (for seasonal switching) and one daily timer.
- Simple connection with single non-polarised two-core wire.
- ME M-Net addressing technology.
- Two function buttons programmable to access any of a choice of functions (Night Set-back, weekly hour timer setting, switch operating mode, adjustable temperature range restriction, local restrictions).
- Recommended for controlling a single system.

Key Technologies

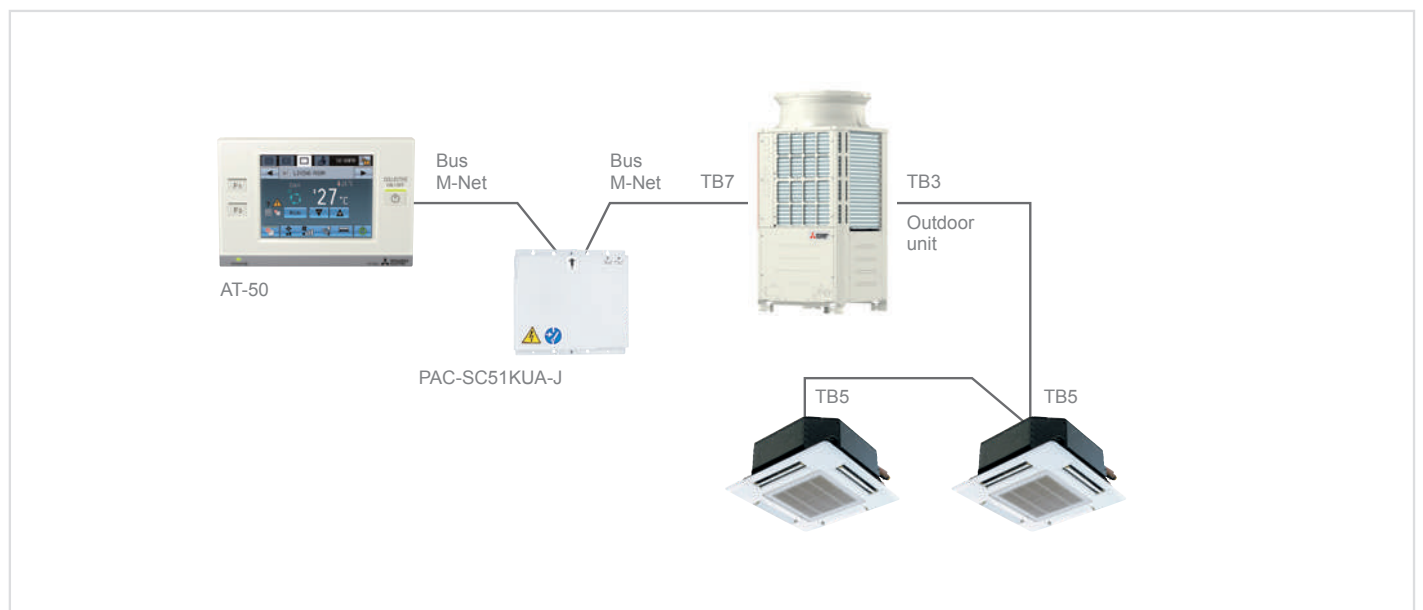

AE-200E

WEB SERVER CENTRALIZED CONTROLLER



3D TOUCH controller

- Generously sized backlit 10.4" SVGA touch screen with graphic layout display function.
- Built-in 240 V AC 50 / 60 Hz power supply.
- Standalone configuration: management of up to 50 indoor units.
- Extended configuration: management of up to 200 indoor units (with 3 expansion controllers EW-50).
- Individual or collective control of groups, blocks or zones.
- Ethernet interface for connection to BMS supervisor systems.
- Integrated WEB server software for management using Internet Explorer®.
- Integrated 2 GB SD memory card for storing system data.
- Direct management of 4 impulse meters with no external interface.
- Power consumption data for billing downloadable via internet connection.
- Complete support for all advanced RMI platform functions for energy consumption monitoring and for multi-installation and multi-user management.
- Temperature setpoints settable and viewable with a precision of 0.5°C.
- Energy saving functions: Maintenance temperature, Sliding temperature, Optimised start, Dual Setpoint.
- M-Net interfacing with Ecodan package Hot Water Heat Pump systems (CAHV and CRHV).
- **Allows direct connection to BMS BACnet NEW**

Superior management, functional and monitoring capabilities with new Mitsubishi Electric controller systems

The 3D TOUCH Controller supports the management, operational and monitoring capabilities of all the new functions offered by the new **ADVANCED remote control**.

Information concerning **occupancy, light levels**, relative humidity in the **indoor space and dual setpoints** is accessible directly from the display and via the WEB.



Key Technologies

				
---	--	--	--	--

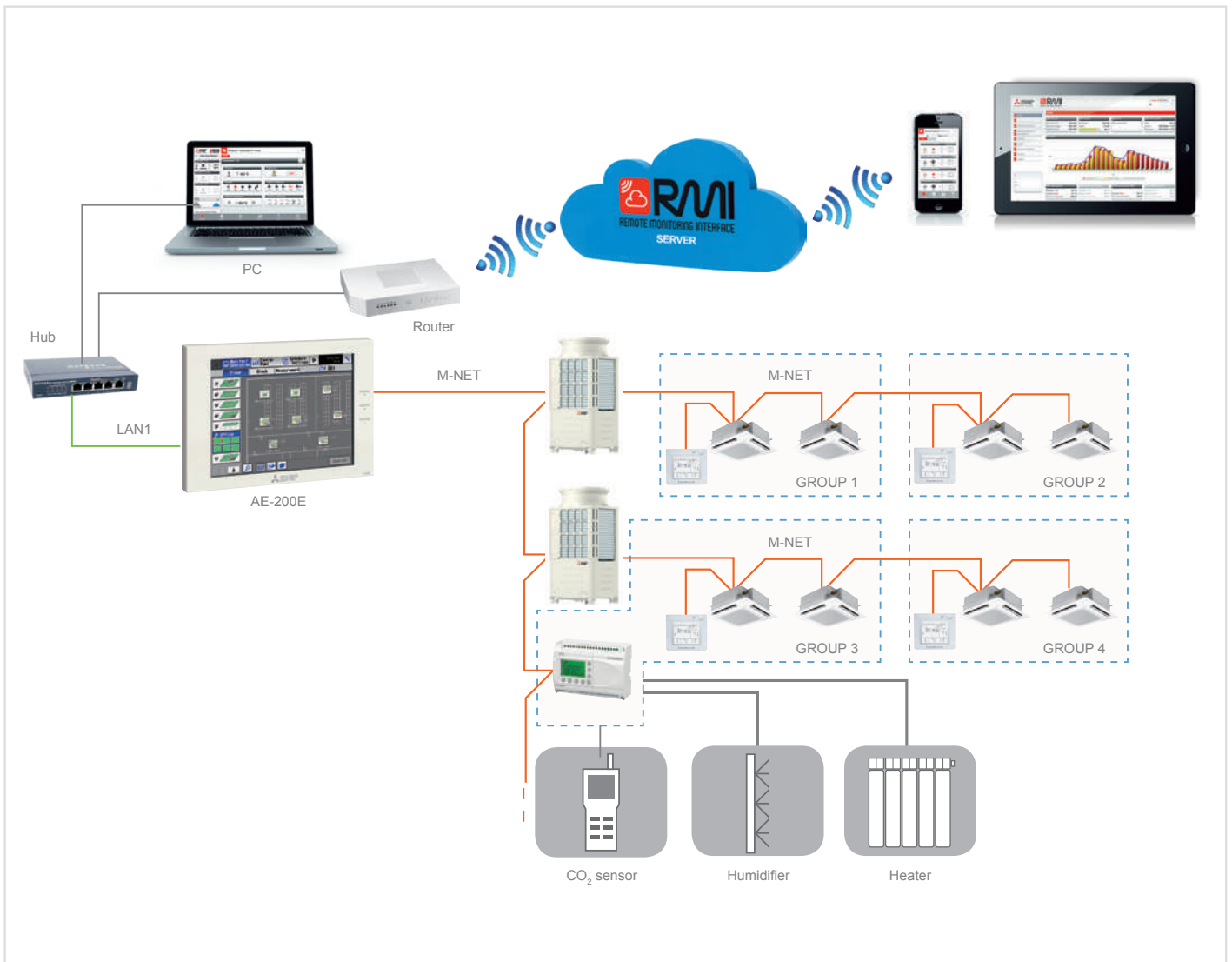

Power and flexibility in a compact device

While measuring practically the same as the previous AG-150, the new 3D TOUCH Controller WEB Server centralized controller offers a larger screen area, greater processing power and expandable flexibility for future applications.

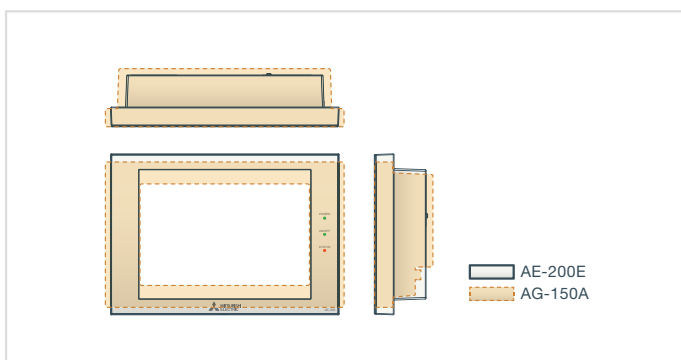

RMI Ready



The **3D TOUCH Controller WEB Server** centralized controller performs the crucial role of acquiring and monitoring data via the M-Net data transmission bus linking all the components of the VRF CITY MULTI, Mr. Slim or Residential system.

A router (available as wired ADSL or 3G Mobile versions) creates a secure, protected communication channel with the RMI Server. The modular flexibility of the RMI Server makes it possible to store enormous volumes of data, which is acquired, processed and archived for access from portable devices.

This infrastructural complexity, combined with superior processing, management and security capabilities, is encapsulated in an extremely user friendly concept, to help users optimise the energy usage of their systems.



EW-50

WEB SERVER CENTRALIZED CONTROLLER



3D blind controller

- “Black Box” version (no display).
- Compact dimensions (external 230V AC power supply).
- Usable to manage 50 groups for a total of up to 50 indoor units.
- Individual or collective group control.
- Ethernet interface for connection to supervisor systems.
- Integrated WEB server software for management using Internet Explorer®.
- Simplified connection, with single non-polarised two-core wire, using ME technology.
- Integrated 2 GB SD memory card for storing system data.
- Direct management of 4 impulse meters with no external interface.

- Status indicator LED indicating data transmission status and/or errors.
- Consumption data for billing downloadable via internet connection.
- A wide choice of energy saving functions offered as standard, with additional optional functions accessible with PIN code licenses.
- Complete support for all advanced RMI platform functions for energy consumption monitoring and for multi-installation and multi-user management.
- **Expansion controller for AE-200.**
- Allows direct connection to BMS BACnet NEW

Key Technologies

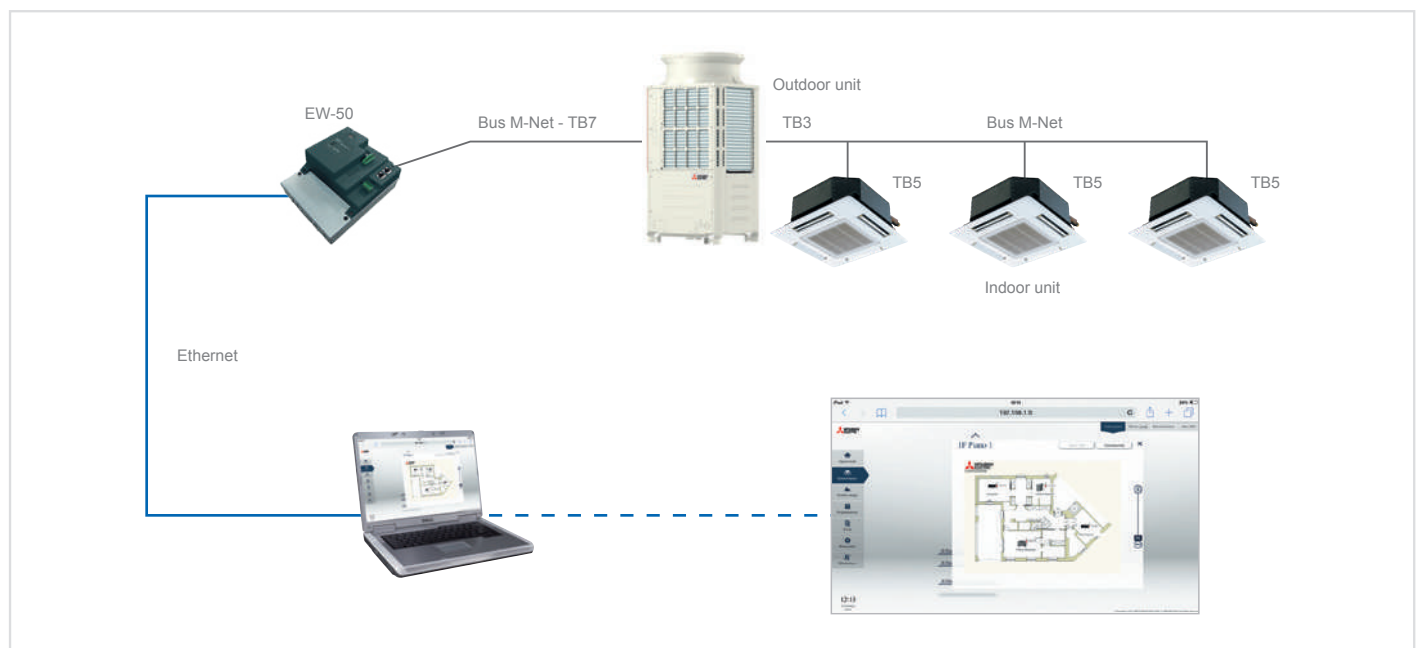

MELCOTEL

INTERFACE FOR HOTEL SIMPLIFIED APPLICATION



MELCOTEL

- Integrated solution interface for small-medium hotels;
- Centralized solution;
- Higher level of control and therefore greater energy saving and a substantial reduction in running costs;
- Key Card contact and Window contact management (1 PAC-SE55RA for each indoor unit is required)
- It works in combination with 1 AE-200 and up to 3 more Web Server Centralized Controllers AE-200/EW-50 (up to 200 Indoor Units).

HOTEL ROOM MANAGEMENT

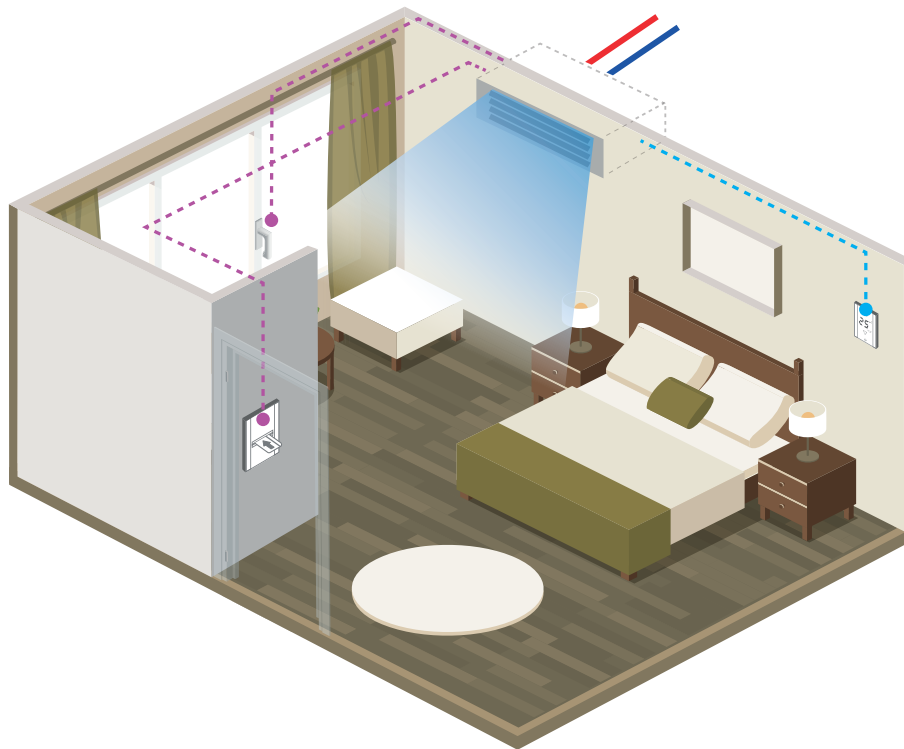

Key card contact and window contact management

The Melcotel Interface allows a hotel to have more accurate control over its air conditioning and can be used to control and monitor up to 200 bedrooms.

KEY CARD CONTACT MANAGEMENT

It allows the resetting of the status (Setpoint Temperature) set by Melcotel when key card is reinserted

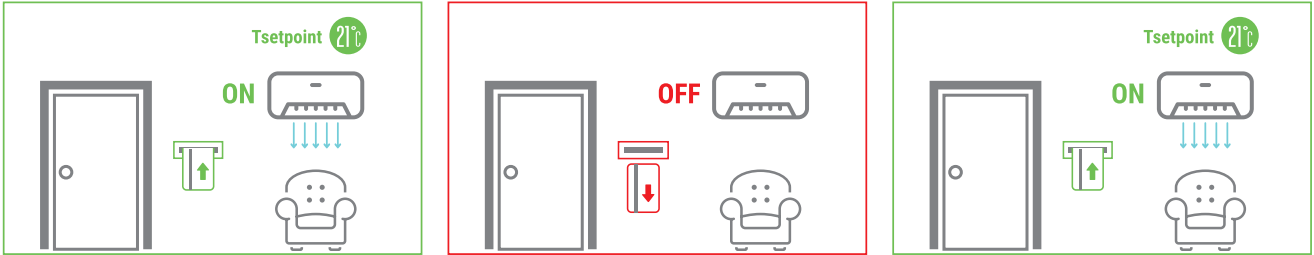

Application example:

When key card is inserted, the indoor unit switches on with the setpoint temperature set by MELCOTEL, for example 21°C. The chamber customer changes the setpoint to 24°C. When key card is removed the indoor unit switches off and remote control is disabled. When key card is reinserted, the indoor unit switches to ON with the setpoint of 21 °C, the one set by MELCOTEL, in order to guarantee energy savings.

WINDOW CONTACT MANAGEMENT

It allows restoring the previous state (ON / OFF status, Setpoint Temperature) when the window is reclosed;

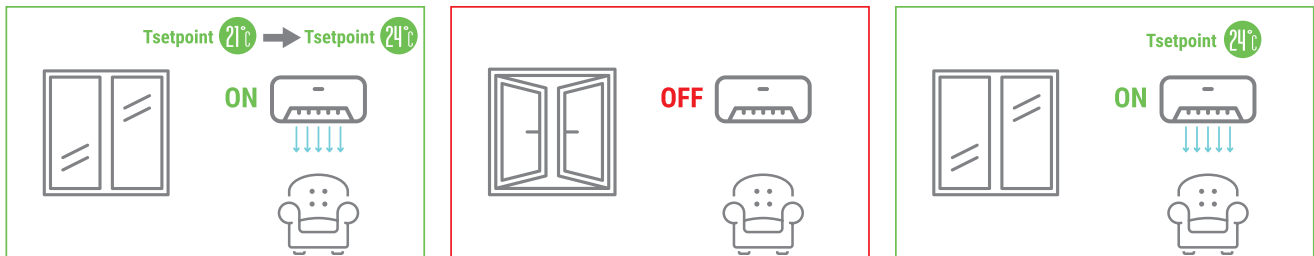

Application Example:

The indoor unit is on and with a setpoint temperature equal to that set by MELCOTEL, for example 21°C. The chamber customer changes the setpoint to 24°C. When the window is opened, the indoor unit switches off and remote control is disabled in order to avoid energy waste. When the window is reclosed, the state prior to opening is restored, i.e. the indoor unit returns to ON and to the setpoint previously set by the customer chamber, i.e. 24 ° C.

ARCHITECTURE

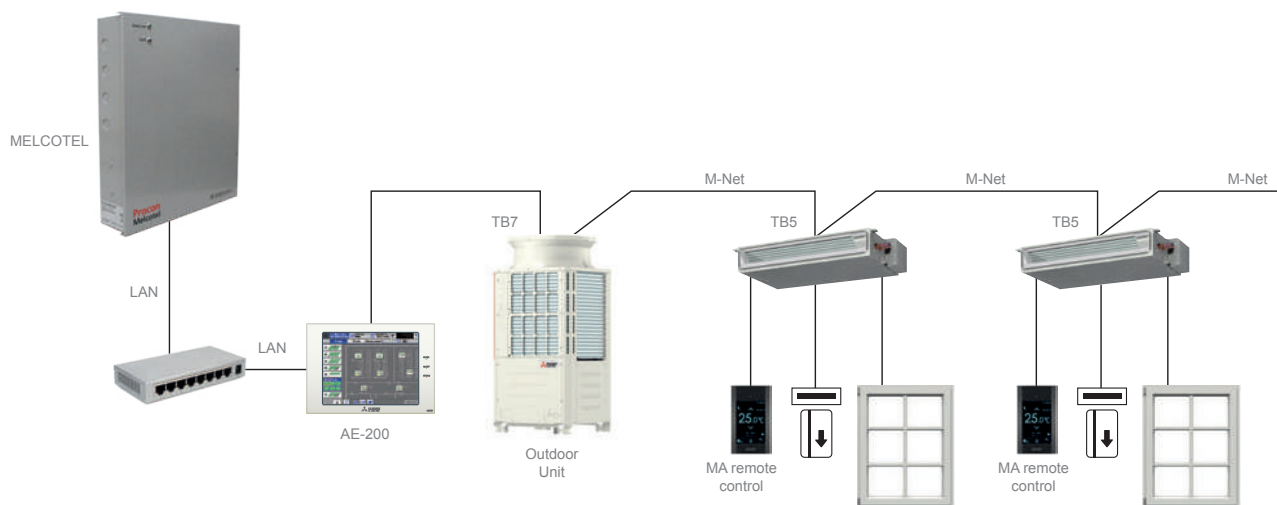

First Centralized Controller HAVE to be necessarily AE-200;
In order to implement the window and/or key card contact system it is necessary to provide one PAC-SE55RA for each indoor unit.





Remote monitoring and control system



3D Tablet Controller

3D Tablet Controller is the new solution by Mitsubishi Electric

allowing portable system management from Smartphone and Tablet **inside the building**. User configuration, with restrictions and privileges, makes it the ideal solution in those application serving different environments, such as offices or apartments. Thanks to its simple and intuitive interface the user is able to control and monitor **air conditioning** and **hot water production** units on **mobile device**, just as easily as he would on a traditional remote control.

This is possible thanks to WEB Server 3D centralized control installed on site, connected to the building Wi-Fi router*1.

*1 Not supplied by Mitsubishi Electric.

INSIDE THE BUILDING



 **MELCloud®** MELCloud
CITY MULTI



• Cloud remote **monitoring and control** system.

- Born for residential applications, it's now being expanded to VRF CITY MULTI.
- **Complete and intuitive** solution with all main control and monitoring functions.
- Does not require WEB Server 3D centralized control (AE-200, EW-50).

 **RMI** RMI
REMOTE MONITORING INTERFACE

• Cloud remote monitoring and control system **for professional use.**

- Allows all main remote control and monitoring functions.
- **Advanced energy monitoring** features are available, such as hourly consumption view, custom charts and data collection and display.
- Geo-localized **multi-site** management.
- **Multi-user** management for centralized systems.
- **Energy consumption apportioning***2.

			
Group/Individual simplified management*2	•	•	•
Available for Smartphone and Tablet	•	•	•
Dedicated App		•	•
User restrictions	•	•	•
Outside the building (Cloud)		•	•
Internet connection needed		•	•
WEB Server centralized control needed	•		•
Advanced energy monitoring			•
Monthly/Custom charts and reports			•
Multi-site management			•
Energy consumption apportioning			•

*2 For compatible product lines please refer to catalogues or contact headoffice

OUTSIDE THE BUILDING



3D TABLET CONTROLLER

WI-FI REMOTE MANAGEMENT SYSTEM



New Wi-Fi management system by Mitsubishi Electric

3D Tablet Controller allows system management and control through Smartphone and Tablet under LAN Wi-Fi coverage.

Simple and intuitive interface

Thanks to its simple and intuitive interface the user is able to freely control air conditioning and water production units from mobile device, inside the building.

This interface has been designed to have the look&feel of a typical App for Smartphone, with immediate feedback from units and fast setting of operating parameters.

Access and components

WEB Server centralized control connected to Wi-Fi router is needed. 3D Tablet Controller is compatible with all Smartphone and Tablets, thank to access through internet browser.

The user can login at the address:

[http://\[AE-200/EW-50 IP address\]/mobile](http://[AE-200/EW-50 IP address]/mobile)





Mobile interface

The web interface has been designed following the modern style of App for Smartphone and Tablet, maximizing easy of use and intuitiveness for mobile use.

Advantages

- Compatible with all Smartphone and Tablet mobile devices, regardless of the brand and operating system.
- No need for internet connection, communication is direct between device, router and centralized controller.
- Possibility to replace the wired remote controls
- Possibility of configuring different users with privileges/restrictions on the available functions

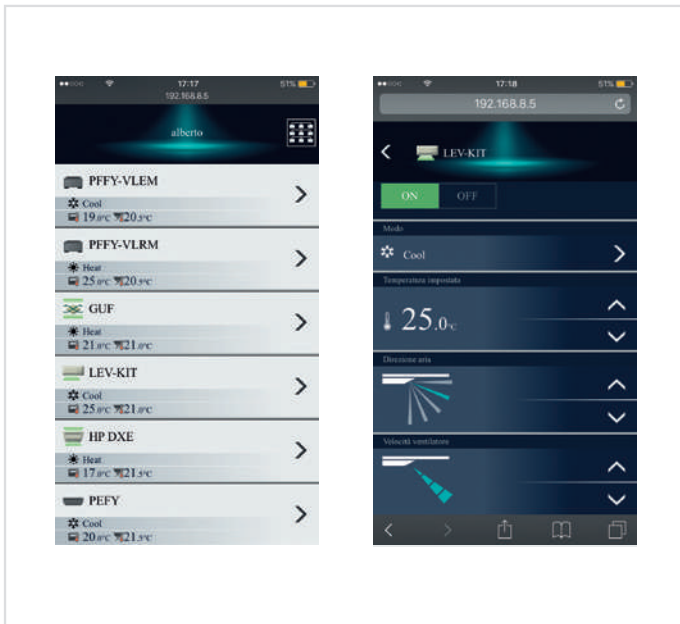

MELCLOUD CITY MULTI

CLOUD-BASED REMOTE MANAGEMENT AND SUPERVISOR SYSTEM



MELCloud, the Wi-Fi controller for VRF CITY MULTI systems.



MELCloud, the new Wi-Fi controller for your Mitsubishi Electric VRF system. By using the cloud for sending and receiving information and the dedicated Wi-Fi interface (MAC-5671F-E), you

can now control your VRF system easily wherever you are from any PC, tablet or smartphone with an internet connection.

The MELCloud service has been designed to ensure complete compatibility with PCs, tablets and smartphones via dedicated apps or via a web browser

Registering the system

The system must be registered to activate the MELCloud service. Once the interface is connected to the indoor unit and paired with the router, the system itself may be registered. To activate Wi-Fi control capability, simply access the website www.melcloud.com, sign up as a user and register the interface used. After registering, you will be able to take full advantage of the potential offered by the MELCloud service and manage your VRF system from any location over the internet.

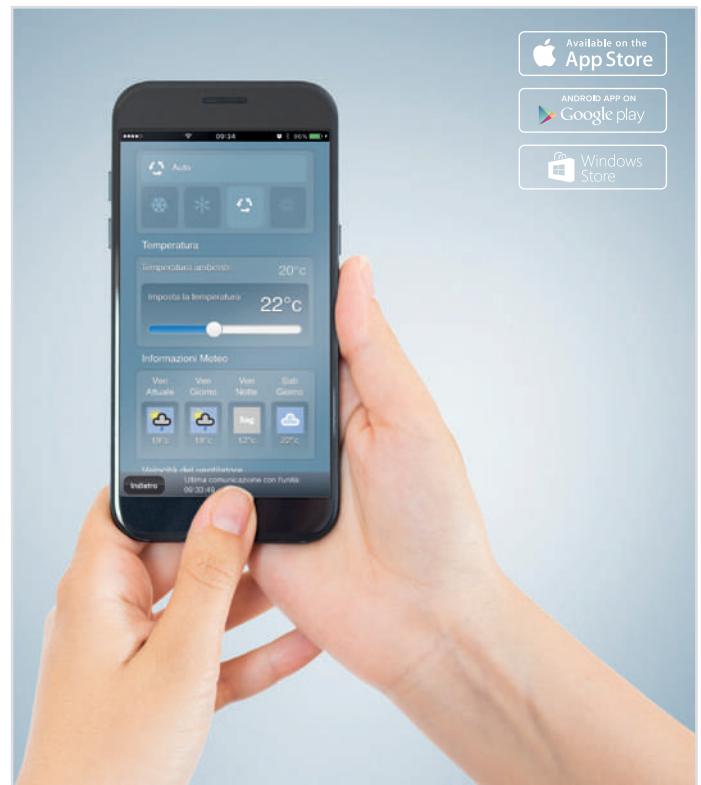

Control functions for CITY MULTI indoor units

Main functions:

- On / Off
 - Mode (Auto/Heat./Cool./Ventilation)
 - Fan speed
 - Programmable weekly timer
 - Louvre angle setting
 - View and set ambient temperature
 - Local weather information
- (availability of functions depends on the model of indoor unit connected to the controller)



Control functions for Lossnay ventilation systems

Main functions:

- On / Off
- Ventilation mode
- Fan speed
- Timer

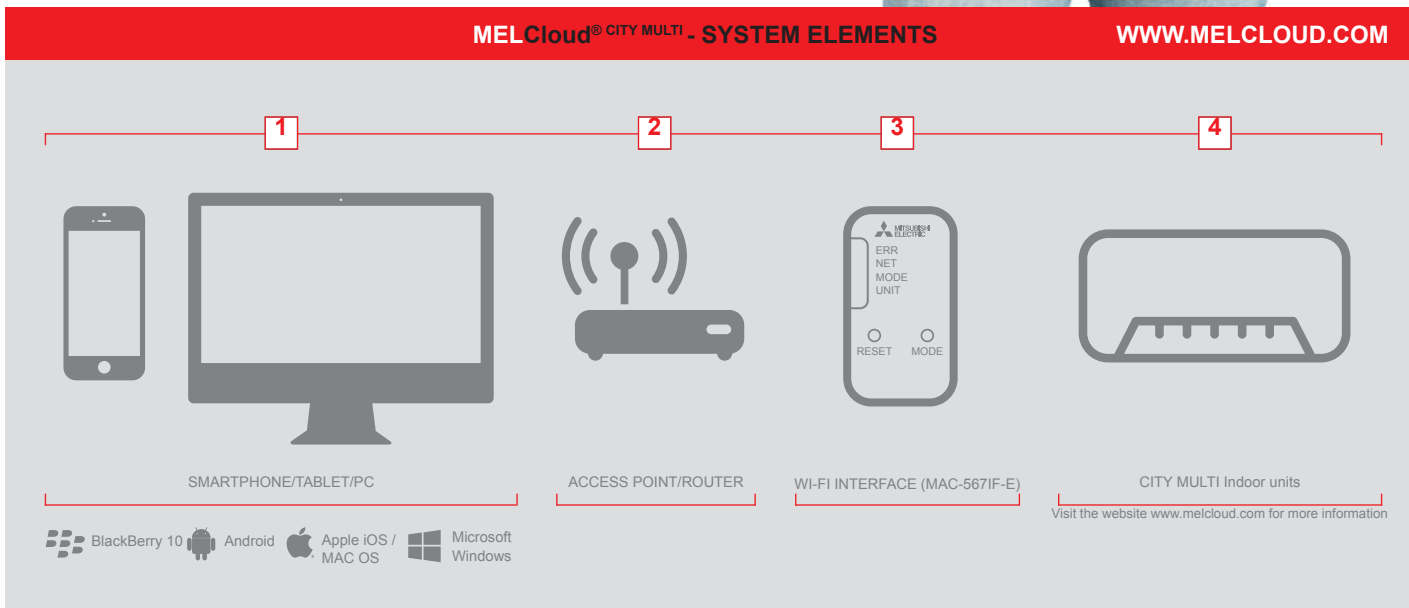

REMOTE MONITORING INTERFACE

CLOUD REMOTE MANAGEMENT SYSTEM



The Cloud system by Mitsubishi Electric for large installations

The RMI system lets you control your air conditioning, heating and domestic hot water production system remotely from a smartphone, tablet or PC. The system may be used to monitor the performance of your appliances, programme functions, check consumption and view operating states to optimise the efficiency of the system.

Your perfect climate in an App!

Control your air conditioner, adjust temperature and air flow settings, view and manage hot and cold water production status and check for system faults.

Simplified control for all of your systems

Set weekly programmes and special events, and view and analyse the operating parameters of your system remotely from a mobile device with a graphic interface that lets you change settings instantaneously when needed.



ALL FROM AN APP ON YOUR SMARTPHONE OR TABLET.

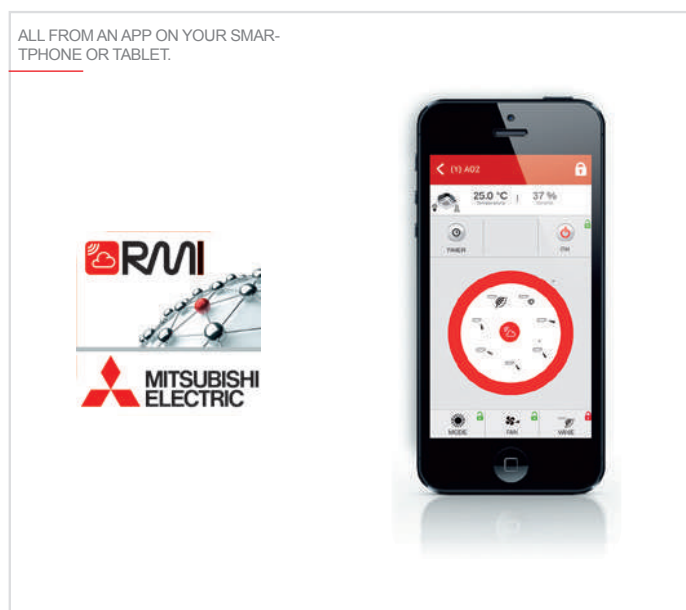

Manage your systems with detailed information and analytical functions

Manage multiple installations with different sizes and architectures conveniently from the application on your PC, view function parameters in a summarised dashboard interface, and analyse specifically created reports to make your installation work even more efficiently. RMI is also the ideal solution for the centralized management and supervision of multiple installations in different locations.



System architecture

The 3D TOUCH Controller WEB Server centralized controller performs the crucial role of acquiring and monitoring data via the M-Net data transmission bus linking all the components of the VRF CITY MULTI, Mr. Slim or Residential system.

A router (available as wired ADSL or 3G Mobile versions) creates a secure, protected communication channel with the RMI Server. The modular flexibility of the RMI Server makes it possible to store enormous volumes of data, which is acquired, processed and archived for access from portable devices. This infrastructural complexity, combined with superior processing, management and security capabilities, is encapsulated in an extremely user friendly concept, to help users optimise the energy usage of their systems.

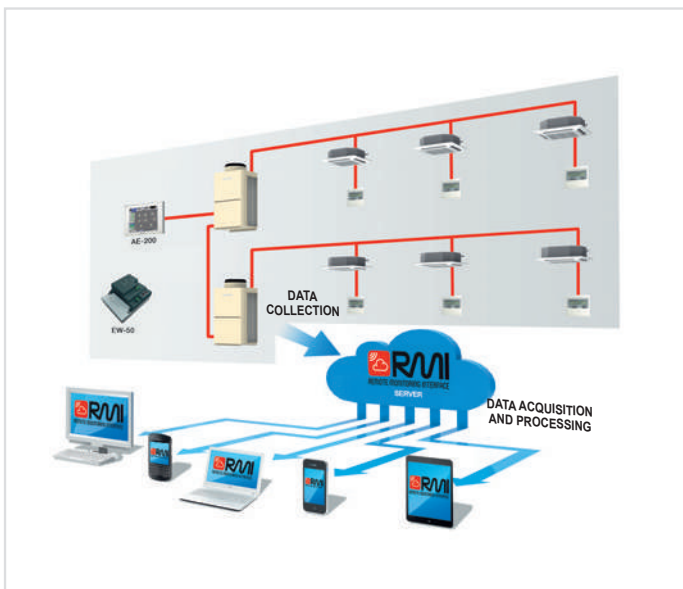

The project

The RMI project is the result of a forward thinking idea by Mitsubishi Electric to offer its customers the capability of managing their installations from portable devices, adding a significant new advantage offered by these systems. The all-new RMI system is the FIRST system of its kind based on **Cloud Computing** technology, which lets you interface with your system via a simple yet secure internet connection. RMI makes it possible to manage Mitsubishi Electric air conditioning solutions, with **energy consumption monitoring and maintenance functions**, from **smartphone** and **tablet** apps for the iOS and **Android** operating systems, and via a private **WEB Client** area **from a PC**. The RMI system is based on a dedicated infrastructure (RMI Server), which may be described as a container for installation data that is collected and made accessible **simply and intuitively**, and filtered and represented appropriately for the type of user analysing and using the data.

The project was designed from the start with security in mind, to protect the installation and the client against unauthorised access with a secure VPN connection (Virtual Private Network).

Who can use RMI?

Because of its many different functions, the RMI system is suitable for all types of installation, from centralized residential systems to commercial applications and large scale installations.

The remote management and monitoring functions are intended for end users (e.g. tenants), owners, administrators, energy/building managers, global service providers and installing and maintenance technicians.

RMI Service packages

RMI can also be applied to an existing VRF CITY MULTI system, by interfacing through the installation's existing WEB Server centralized controllers. Contact head office to check compatibility between hardware and available functions.

See DEMO RMI at:

<http://demo-it.rmi.cloud>

RMI IS AVAILABLE IN THE FOLLOWING PACKAGES

 **RMI SMART**
REMOTE MONITORING INTERFACE

 **RMI ADVANCED**
REMOTE MONITORING INTERFACE

 **RMI MULTI-TENANT**
REMOTE MONITORING INTERFACE

 **RMI PLAN**
REMOTE MONITORING INTERFACE

 **RMI CHARGE**
REMOTE MONITORING INTERFACE

XML

BMS INTERFACE FOR ETHERNET NETWORKS

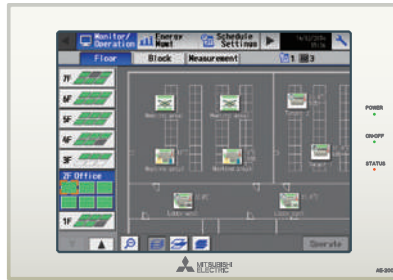

AE-200



EW-50

XML BMS interface for ethernet networks

XML is an innovative new communication system developed specifically for exchanging data over the web. XML makes it possible to create custom software extremely simply, which can even be used with a standard internet browser. The XML protocol makes it possible to integrate with a BMS system using the AE-200E or EW-50 WEB Server centralized controllers, with no additional dedicated hardware interfaces. As all the information necessary for the BMS system is available in XML

format directly over the Ethernet communication port of the AE-200E / EW-50 controller, all that needs to be done is to connect both the AE-200E / EW-50 WEB Server centralized controllers and the BMS computer system to the same network. Connecting to a BMS system with the XML protocol is extremely simple, as the Ethernet network platform is used. No dedicated conversion or interface hardware is needed, as shown in the typical layout schematic.

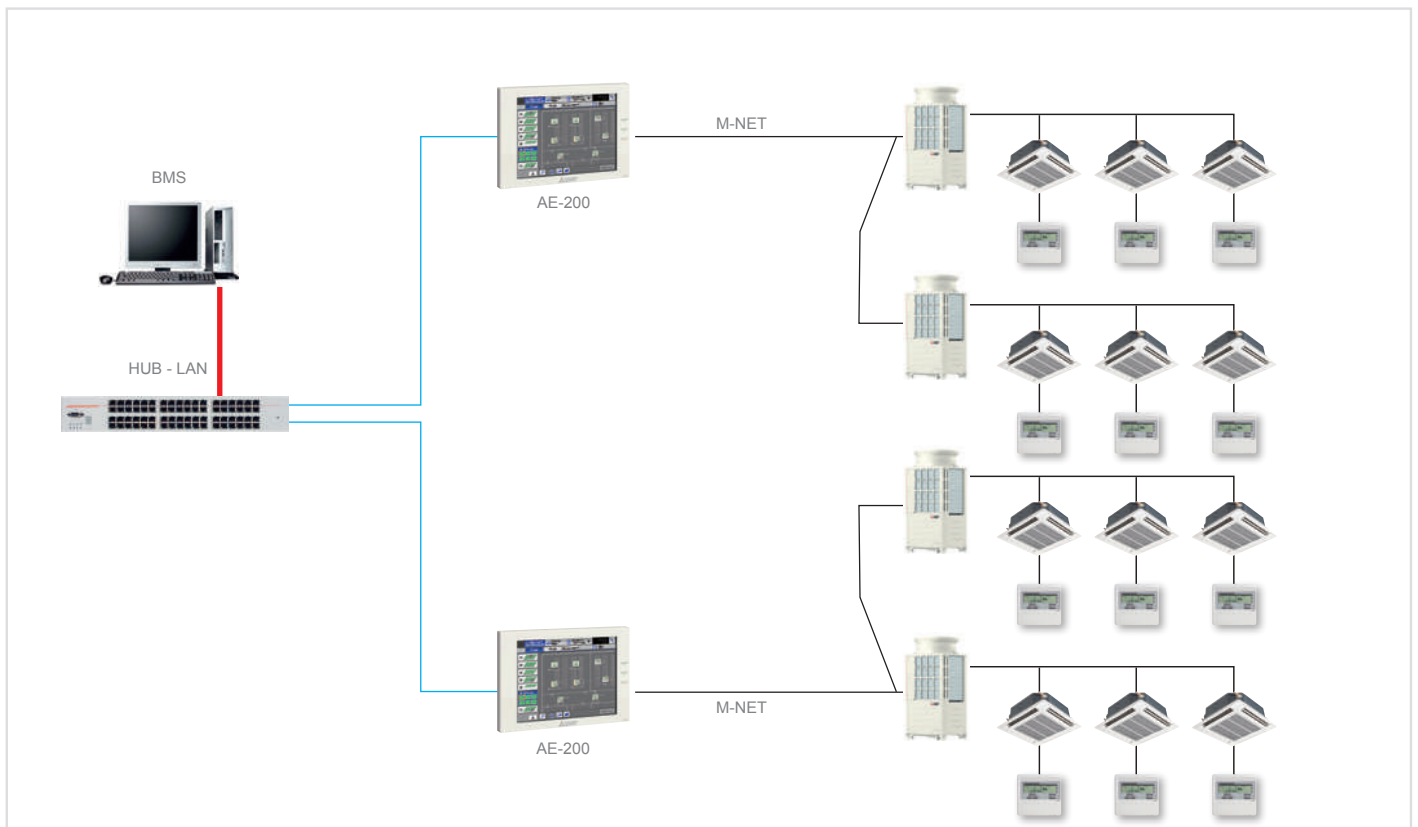

ME-AC-MBS-KNX-100

B.M.S. INTERFACE FOR MODBUS® AND KNX NETWORKS®



ME-AC-MBS-KNX-100

With this gateway **ME-AC-MBS-KNX-100**, you can easily integrate Mitsubishi Electric's City Multi systems into an installation based on Modbus TCP, Modbus RTU, KNX, BACnet/IP. To do this, the gateway acts as a server device for the installation itself, accessing all signals from each air-conditioning unit and controlling the entire air-conditioning network.

The gateway is continuously interrogating the air conditioning network, storing in its memory the current status of each signal to be monitored and providing this data to the installation when requested.

In addition, when the status of a signal changes, the gateway sends a write telegram to the installation, waits for a response and performs the corresponding action. A non-response from a signal triggers a communication error, allowing you to know which signal from which airconditioning unit is malfunctioning.

The interface is connected to the Modbus supervisory system via an RS232/RS485 or TCP/IP over Ethernet connection and via Ethernet to the Mitsubishi Electric VRF CITY MULTI system.

NEW B.M.S INTERFACE FOR

ModBus TCP
ModBus RTU
KNX
Control up to a maximum of 100 IUs

Fully backward compatible with the same variable addresses used in the old hardware



B.M.S. interface - for Modbus networks®

The Modbus protocol is a communication protocol originally used for PLC networks. Mitsubishi Electric offers an interface for the management of up to 100 indoor units (ME-AC-MBS-KNX-100) for management via B.M.S. of the VRF CITY MULTI system.

The interface is connected to the Modbus supervisory system via either an RS232/RS485 or TCP/IP over Ethernet connection and via

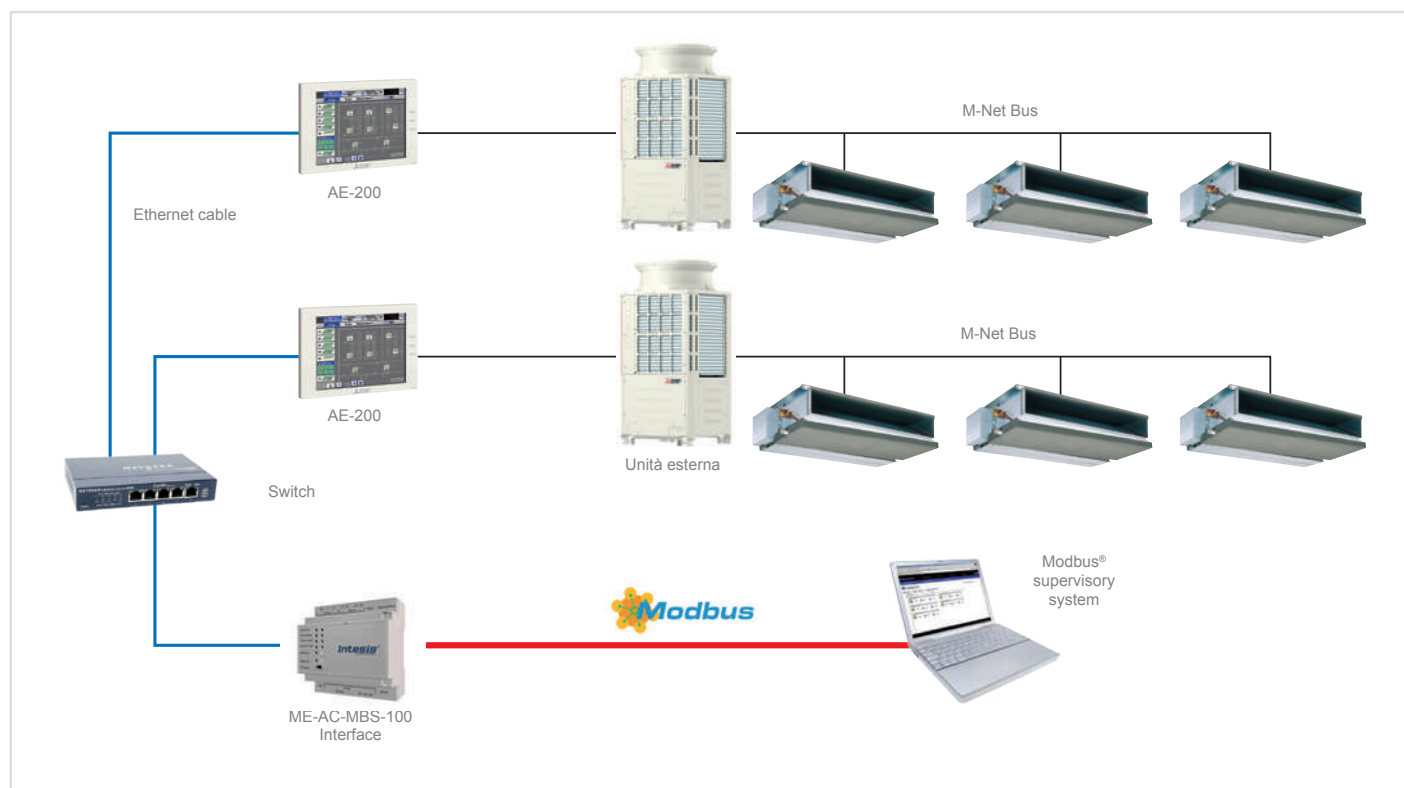

Function table

OPERATION	
FUNCTION	DESCRIPTION
On/Off	Unit on/off setting
Mode	Setting the operating mode
Set Temperature	Setpoint temperature setting
Air direction	Setting airflow direction
Fan speed	Setting ventilation speed
Prohibit remote control	Remote control prohibition setting
Prohibit Local On/Off	Setting prohibition command On/Off
Prohibit local mode change	Operation mode change command prohibition setting
Prohibit Temperature Set	Setpoint setting prohibition
Prohibit local filter signal reset	Filter signal reset prohibition setting
Lossnay ventilation set	Lossnay ventilation speed setting
Reset filter signalling	Reset filter signal
Reset error status	Reset error status
Active polling	Activation/deactivation of group polling
Forced off	Forced shutdown

Function table

MONITORING	
FUNCTION	DESCRIPTION
On/Off	Unit on/off setting
Communication error	Communication error with centraliser
Mode	Setting the operating mode
Set Temperature	Setpoint temperature setting
Air direction	Airflow direction setting
Fan speed	Setting ventilation speed
Prohibit remote control	Remote control prohibition setting
Prohibit Local On/Off	Setting prohibition command On/Off
Prohibit local mode change	Operation mode change command prohibition setting
Prohibit Temperature Set	Setpoint setting prohibition
Prohibit local filter signal reset	Filter signal reset prohibition setting
Lossnay ventilation set	Lossnay ventilation speed setting
Signal filter	Dirty filter signal
Error signal	Unit signal in error
Internal temperature	Indoor room temperature display
Reset filter signalling	Reset filter signal
Reset error status	Reset error status
Group communication error	Group communication error
Active polling	Polling on/off display per group
Forced off	Forced shutdown

B.M.S. interface - for KNX networks®

KNX is one of the world's standard protocols for home and building control. This open protocol ensures product interoperability and compatibility of third-party products. Mitsubishi Electric offers an interface for the management of up to 100 indoor units (ME AC KNX - 100) for

management via B.M.S. of the VRF CITY MULTI system. The interface is connected directly to the EIB bus to the KNX world and via Ethernet to Mitsubishi Electric's VRF CITY MULTI system.

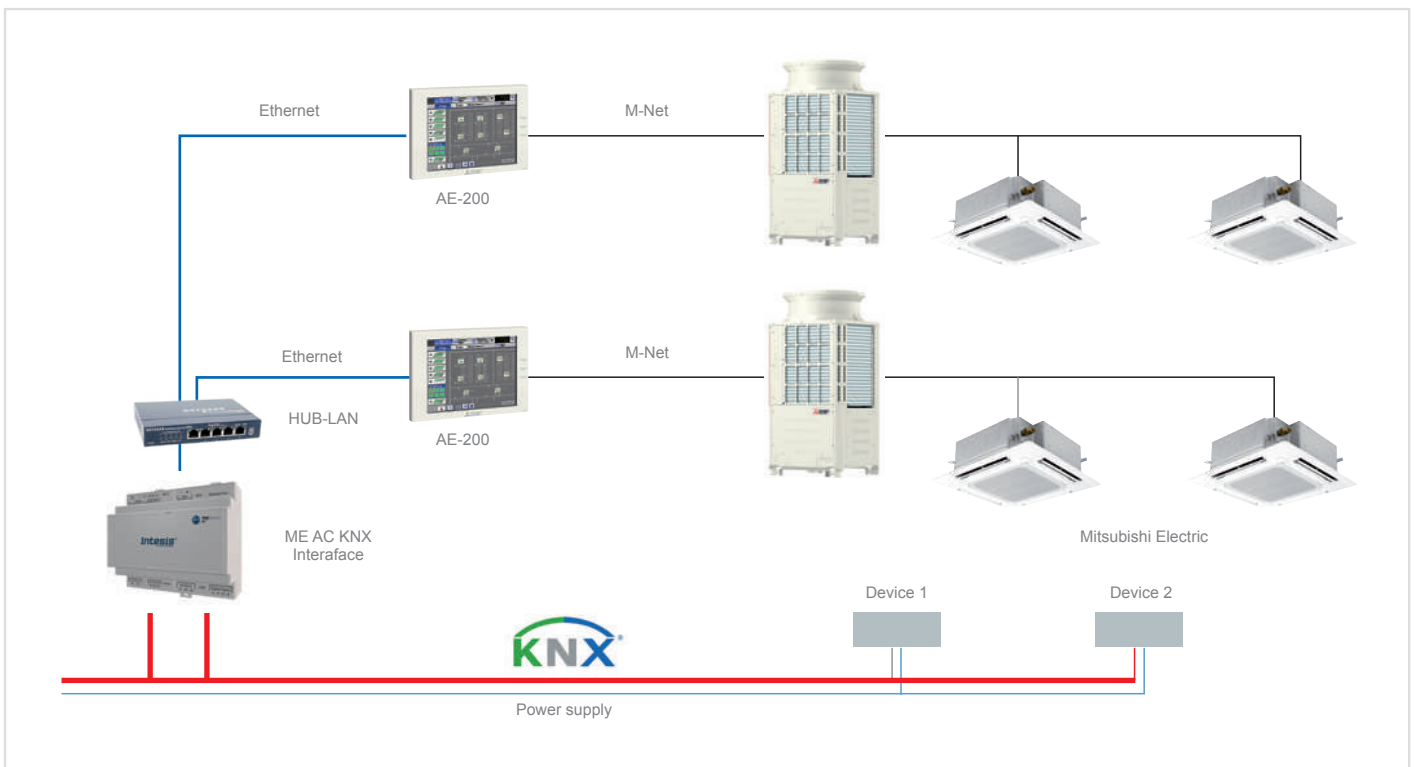

Function table

OPERATION	
FUNCTION	DESCRIPTION
On/Off	Unit on/off setting
Mode	Setting the operating mode
Set Temperature	Setpoint temperature setting
Air direction	Setting airflow direction
Fan speed	Setting ventilation speed
Prohibit remote control	Remote control prohibition setting
Prohibit Local On/Off	Setting prohibition command On/Off
Prohibit local mode change	Operation mode change command prohibition setting
Prohibit Temperature Set	Setpoint setting prohibition
Prohibit local filter signal reset	Filter signal reset prohibition setting
Lossnay ventilation set	Lossnay ventilation speed setting
Reset filter signalling	Reset filter signal
Reset error status	Reset error status
Inlet Temp	Virtual setpoint setting (temperature supplied by KNK)
MONITORING	
FUNCTION	DESCRIPTION
On/Off	Unit on/off setting
Communication error	Communication error with centraliser
Mode	Setting the operating mode
Set Temperature	Setpoint temperature setting
Air direction	Setting airflow direction
Fan speed	Setting ventilation speed
Prohibit remote control	Remote control prohibition setting
Prohibit Local On/Off	Setting prohibition command On/Off
Prohibit local mode change	Operation mode change command prohibition setting
Prohibit Temperature Set	Setpoint setting prohibition
Prohibit local filter signal reset	Setting prohibition reset filter signalling
Lossnay ventilation set	Lossnay ventilation speed setting
Signal filter	Dirty filter signal
Error signal	Unit signal in error
Internal temperature	Indoor room temperature display
Reset filter signalling	Reset filter signalling
Reset error status	Reset error status
Group communication error	Group communication error
Inlet Temp	Virtual temperature display (provided by KNK)

Lista di compatibilità

MONITORING	
G-50	AE-200
G-50A	AE-50
GB-50A	AG-150A
GB-50ADA	EW-50
AB-150	EB-50GU

BACnet® PIN CODE

BMS INTERFACE FOR BACNET® NETWORKS

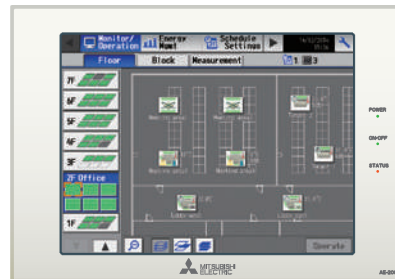

BACnet® PIN code

The BACnet® protocol was originally developed by ASHRAE in North America specifically for HVAC applications (Heat, Ventilation, Air Conditioning). It was subsequently also adopted in Europe as one of the standard communication solutions for air conditioning systems, together with LonWorks® and other protocols. One of the greatest advantages of this protocol is the extraordinary degree of cross-compatibility it offers, allowing systems from different manufacturers to be integrated with each other. New BACnet PIN code allows communication between Mitsubishi Electric system and BACnet BMS network with the same monitoring

information and settings which were available with BAC-HD150. **BACnet PIN code is available only for WEB Server 3D centralized controls (AE-200, EW-50).** Physical connection is via Ethernet cable through a dedicated port on centralized control. Thanks to new BACnet PIN code it is possible to remove one hardware component (BAC-HD150) from the system, simplifying its structure and removing one potential source of malfunction. Each centralized control equipped with BACnet PIN code is able to handle up to 50 indoor units and 50 groups.

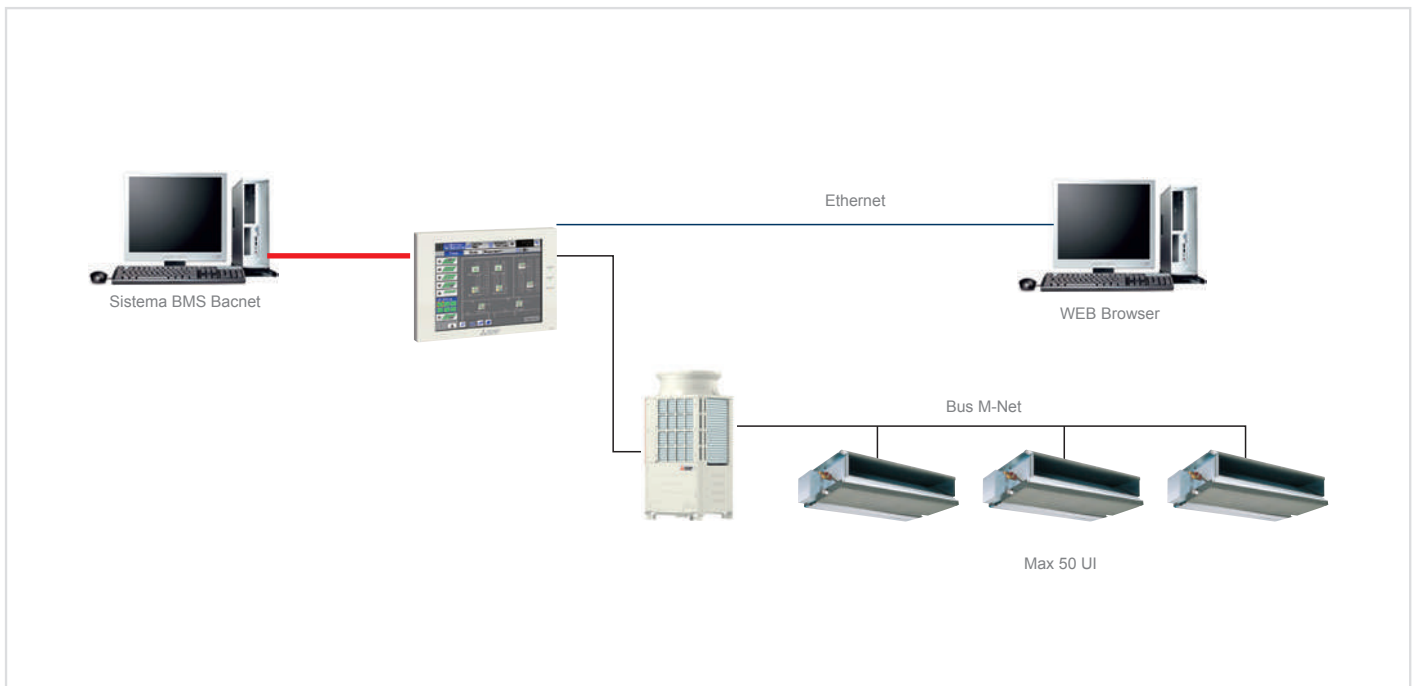

Applied Hydronic systems

ME-series Modular Chillers and heat pumps

MECH-MEHP Line	314
EAC(H)V Line	332



Formidable. In every aspect.

ME-series **R32**
EUROVENT
CERTIFIED
PERFORMANCE

Air source chillers and reversible heat pumps with Mitsubishi Electric variable speed scroll compressors and R32 low GWP refrigerant. From 50 to 220 kW.



MECH-iS-G07

1 2 3 4 5

MEHP-iS-G07

1 2 3 4 5

Brand	1	ME - Mitsubishi Electric
Unit type	2	CH - Chiller unit HP - Heat pump unit
Technology	3	i - Inverter driven
Compressor type	4	S - Scroll
Refrigerant	5	

NEW

MECH-iS-G07 and MEHP-iS-G07 are the new Mitsubishi Electric chiller and heat pump ranges designed with the utmost care in terms of quality and details. Dedicated to different applications, from comfort to industrial or IT cooling processes, MECH-iS-G07 and MEHP-iS-G07 achieve top-level energy efficiencies, in the most compact footprints in their category.

Extended range

7 new sizes developed in 3 compact modules to fit any thermal load request up to 110 kW, extendable up to 220 kW through the optional twin module configuration, the connection of two modules of the same size.

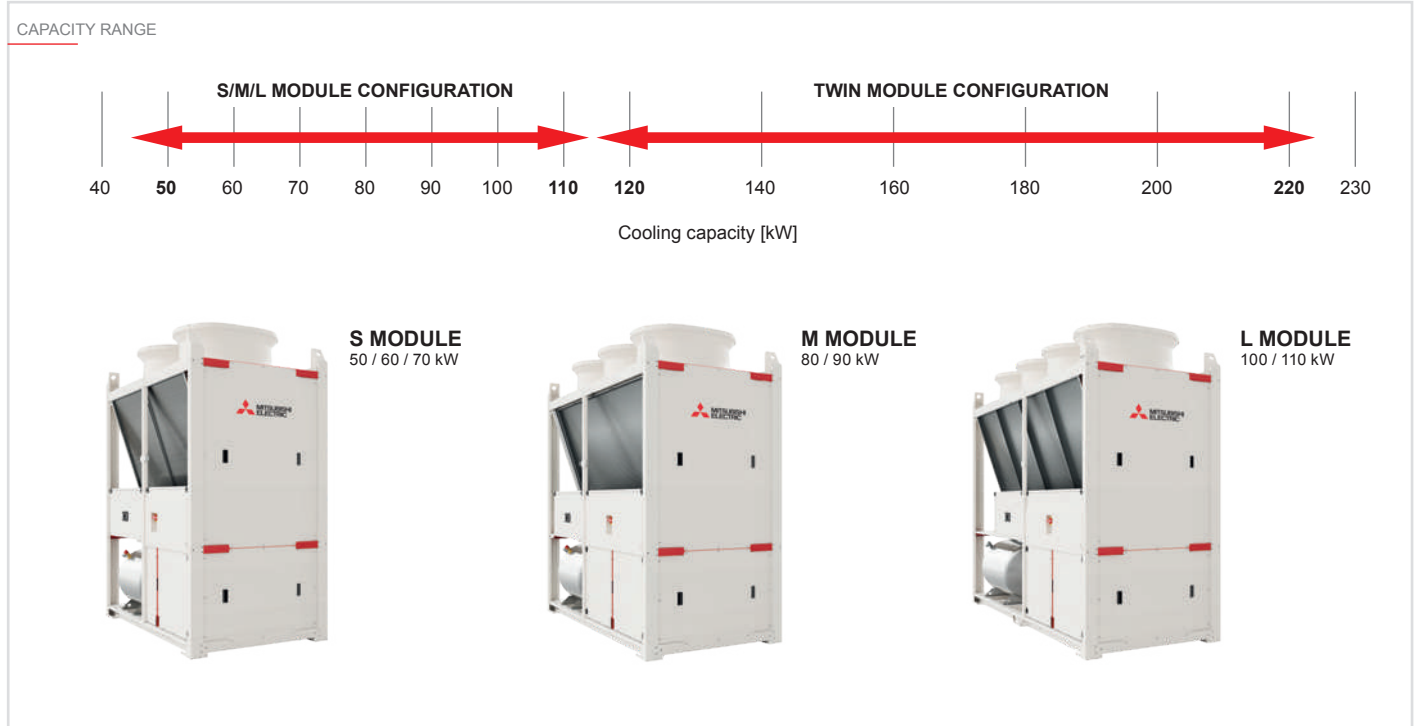



Key technologies

Electrical Control Box

W3000+ control software, available with standard keyboard or touch screen, features proprietary settings, to perfectly manage each single product dynamic.



Complete Hydronic Kit Options

Factory-installed several pumps (with VPF options) and buffer tank (opt.)

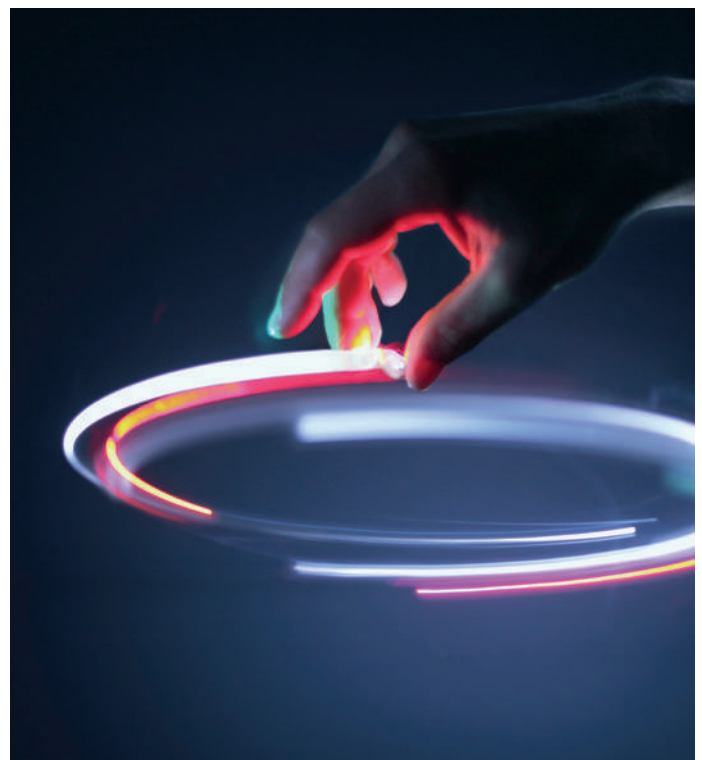

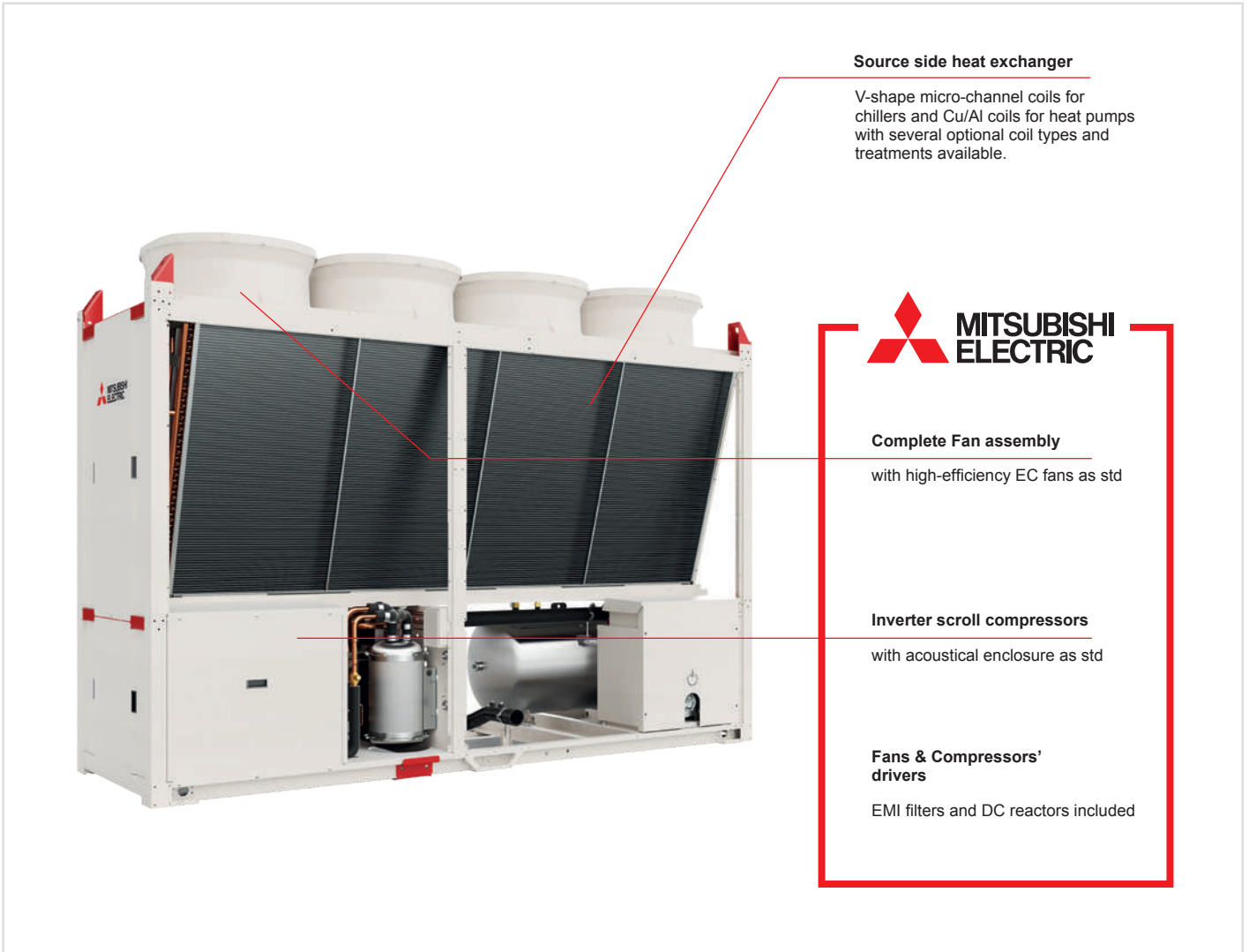

Source side heat exchanger

V-shape micro-channel coils for chillers and Cu/Al coils for heat pumps with several optional coil types and treatments available.



Complete Fan assembly

with high-efficiency EC fans as std

Inverter scroll compressors

with acoustical enclosure as std

Fans & Compressors' drivers

EMI filters and DC reactors included

Mitsubishi Electric quality

MECH-iS-G07 and MEHP-iS-G07 ranges have been perfectly designed to achieve the highest quality standards, adopting the Japanese Poka Yoka technique.

Poka-yoke

The 'Zero Defects' idea

Poka Yoke is a Japanese term that means "mistake-proofing" approach applied on the equipment manufacturing processes. This implies activities that help an equipment operator avoid (yokeru) mistakes (poka) and defects, and the selection of technological choices that make maintenance activities as easy as possible.

Scroll compressor

- Proprietary Mitsubishi Electric compressor
- VSD compressor with BLDC motor for outstanding seasonal efficiencies
- Motor's shape designed to reduce vibrations and to assure the lowest sound power emissions
- Injection gas refrigerant into compressor with medium temperature for increased capacity and efficiency
- All rotating parts are designed to guarantee absolute reliability in every operating condition
- Unrivalled operating map to suit every kind of application: Comfort, Process or IT Cooling without any limitation



COMPRESSOR CONFIGURATIONS

i = inverter



S MODULE

1+i = 1 x inverter
1 x on/off



M MODULE

1+i = 1 x inverter
1 x on/off



L MODULE

VSD single-compressor or VSD solution (1+i) tandem configuration, Mitsubishi Electric proprietary technology

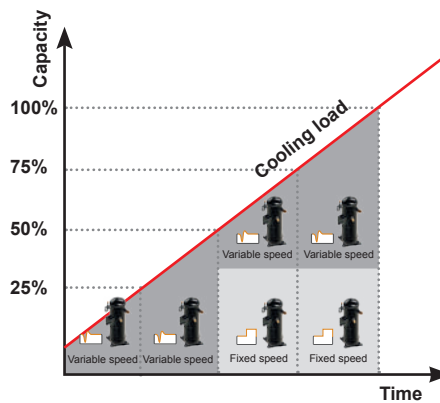

- High seasonal efficiency
- Stable leaving water temperature
- Continuous capacity modulation
- Perfect and accurate load delivery in all working conditions

Axial fan

High performing, 700mm-diameter variable speed axial fans (with inverter driven BLDC motor).

Fan, fan motor, inverter and the layout of the external bell mouth are Mitsubishi proprietary technologies, for the highest efficiency and very low sound power levels.

High-end-components designed to achieve very high efficiencies, minimizing the sound level of the unit.

POKA-YOKE Philosophy: smart design in order to avoid mistakes during assembly operations and to simplify maintenance operations. Quick couplers for fans for an easier and quick connection.

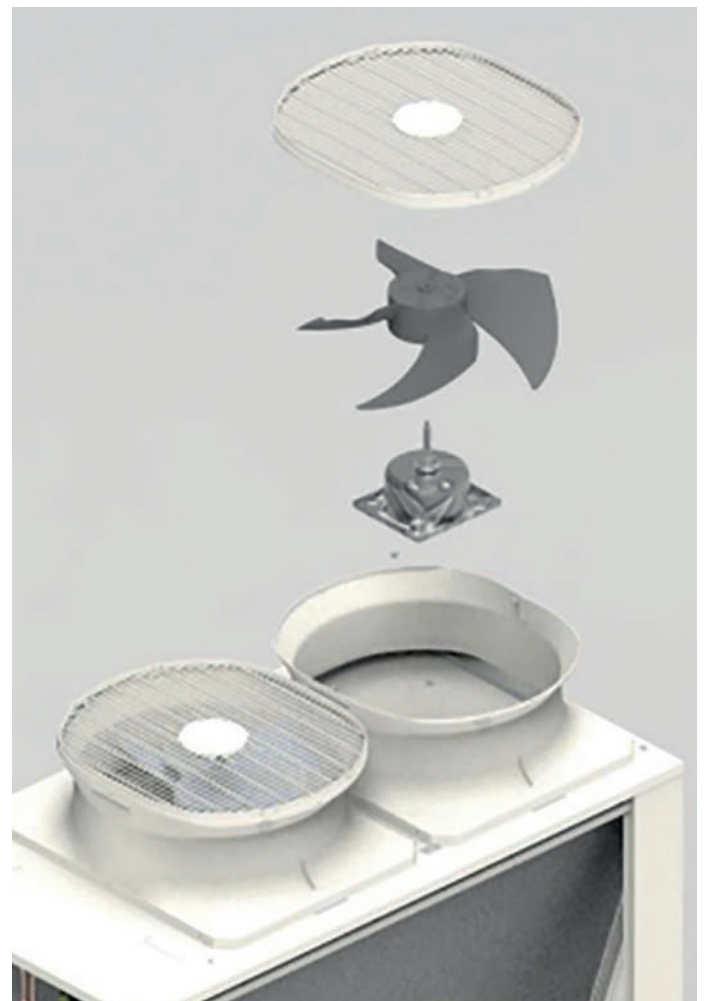

AXIAL FAN

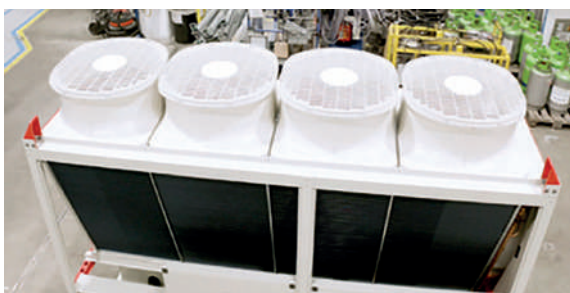
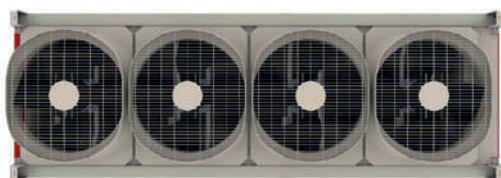

Why R32?

MECH-iS-G07 and MEHP-iS-G07 with R32 refrigerant are key in the company's path towards the creation of a greener future

The reduced GWP level of this refrigerant gas tackles both direct and indirect global warming, offering customers a concrete forward-looking solution for your building and a concrete alternative to traditional refrigerants.

R32



Low GWP
-66% GWP vs R410A



Safety Class A2L

Reduced Environmental Impact



- ODP - Ozone Depletion Potential
- One-third GWP that R410A
- F-Gas phasedown compliant

Performance & Envelope



- Ideal for the next generation of equipment
- Requires less refrigerant volume per kW
- High refrigeration and thermal conductivity
- Low pressure drops
- Affordable and readily available

Reliability



- Easy to handle, reuse, and recycle
- Low toxicity, low flammability
- A single component refrigerant

Designed down to a fine art

Groundbreaking performance. Especially in partial load



MECH-iS-G07 and MEHP-iS-G07 bring brilliant performance, particularly in partial load conditions, thus helping individuals and business reduce the energy bill of their HVAC system.

MECH-iS-G07			
up to	EER: 3.3	SEER: 5.6	SEPR HT: 6.5

EER – conditions: evap. 12/7 C, air 35 C – NET values [EN14511 – EN14825]

SEER – Regulation (EU) N.2281/2016

SEPR-HT – Regulation (EU) N.2281/2016

MEHP-iS-G07			
up to	COP: 3.4	SEER: 4.6	SCOP LT: 4.6 SCOP MT: 3.5

COP – conditions: cond. 40/45 C, air 7(6) C – NET values [EN14511 – EN14825]

SCOP LT – Regulation (EU) N.813/2013

SCOP MT – Regulation (EU) N.813/2013

Supreme class quietness

Best-in-class sound levels without additional accessories. MECH-iS-G07 and MEHP-iS-G07 units are equipped as standard with the acoustical enclosure for compressors and hydronic kits.

Best-in-class footprint

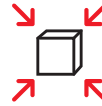

Extremely compact footprint, among the best in the category. The reduced width of the units is ideal for multi-unit transportation, optimizing the shipping spaces and shipment via container.

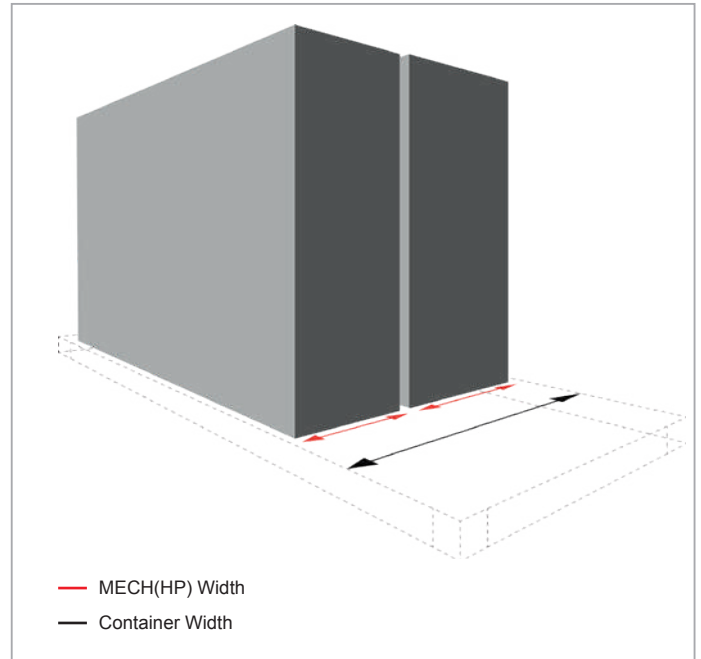

Wide operating range

Going beyond ordinary limits of standard heat pumps and chillers, MECH-iS-G07 and MEHP-iS-G07 ranges achieve extreme water temperatures, making these units ideal for many uses from Comfort to Process and IT Cooling applications.

Matching mission critical applications requirements

MECH-iS-G07 can operate with outdoor temperatures up to **+50 C** and chilled water temperatures from **-12 C** to **+24 C**, significant values which make these units ideal for Process and IT Cooling applications.

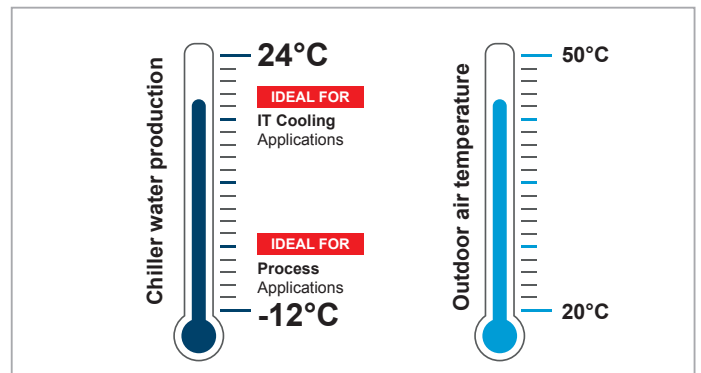

One unique unit for heating, cooling and producing hot water

MEHP-iS-G07 can produce, alone and without any auxiliary accessory, both medium temperature water for space heating and cooling, and hot water for domestic use up to 65 C. These key features make MEHP-iS-G07 an interesting alternative for classic gas or fuel oil heating systems.

- Use of renewables sources
- Considerable energy savings
- Green footprint

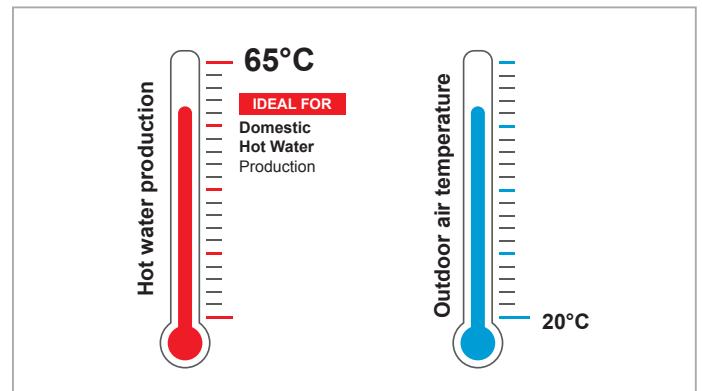

Group control systems integrated solutions

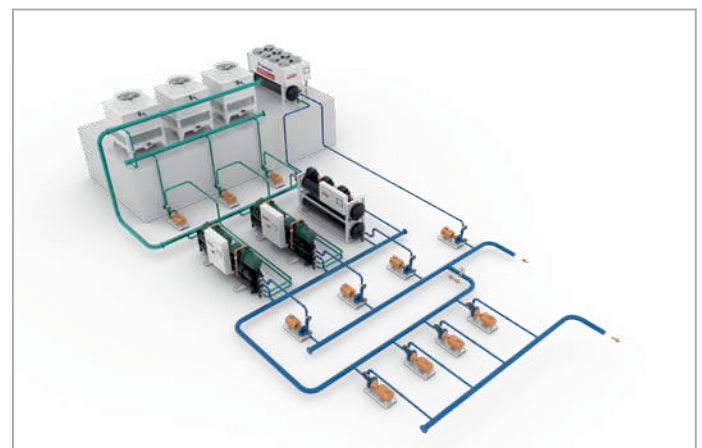

Architecture	Exploits proprietary LAN technology to connect a group of chillers and heat pumps.
Interfacing	Completely integrated in the units.
Applications	<ul style="list-style-type: none"> • Multi Manager Comfort, Process and IT Cooling applications. Chillers and heat pumps. • HPC IT cooling applications. Chillers and CRAHs (Computer Room Air Handlers)
Function	Smart management of the group of units with dynamic master logic, stand-by management, load and resource management.

Smart coordinated defrost

Smart control logic for coordinating the non-simultaneous start of defrosting cycles of a group of heat pumps:

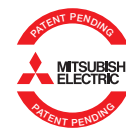

- Minimization of the energy required for defrost
- Increase of the maximum heat output of the system which can be constantly supplied
- Increased system efficiency
- Minimum impact on leaving water temperature

Multimanager

With opt. 1541 and 1542 – MULTI MANAGER, MECH-iS and MEHP-iS ranges feature **embedded LAN logics for an easy connection between group of units**. The entire cooling equipment works as one, with **one master unit that coordinate and optimize the operation of the unit group**:

- **Up to 8 units connected on the same group**
- **Load sharing and Sequencing logics** for the smart distribution of thermal loads among the units
- **No simultaneous start-ups of different unit's compressors**, to prevent dangerous current peaks, but a selectable units' start-up sequence
- **Stand by unit management with automatic unit rotation.**
- **Dynamic master with succession priority:** one master unit is elected to coordinate the equipment group and once it becomes disconnected, the candidate unit takes full control.
- **Resource prioritymanagement:** In case of a varying group of units, with different technologies, it is possible to set the usage priority of each unit, making the most of the available thermal resources.

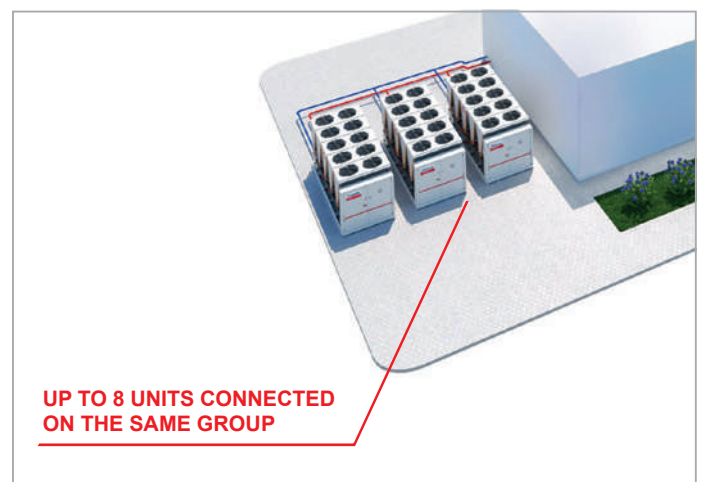

RANGE EXTENSION UP TO 880KW. MAXIMUM EFFICIENCY ON PARTIAL LOADS CONDITIONS.

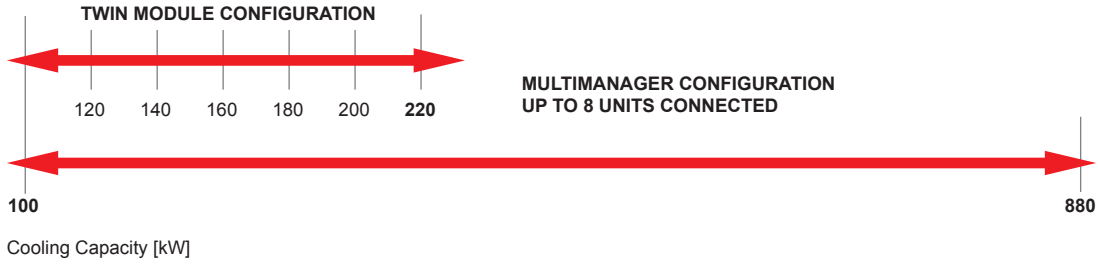

Dynamic master with succession priority

One master unit is elected to coordinate the equipment group and once it becomes disconnected, the candidate unit takes full control.

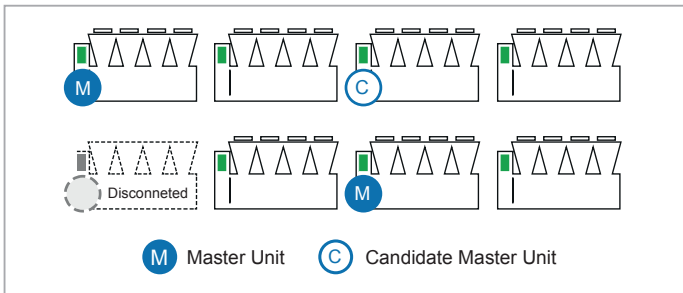

Resource priority management

In case of a varying group of units, with different technologies, it is possible to set the usage priority of each unit, making the most of the available thermal resources.

HPC (Hydronic Plant Connect)

System approach: Chillers + CRAHS

A complete Mitsubishi Electric cooling package dedicated to your high efficiency data center. **Up to 20 groups of CRAHs are connected to the group of chillers.**

Proprietary LAN network for the optimization of the entire cooling system: CRAHs, chillers, FC availability, fans, pumps, and valves.

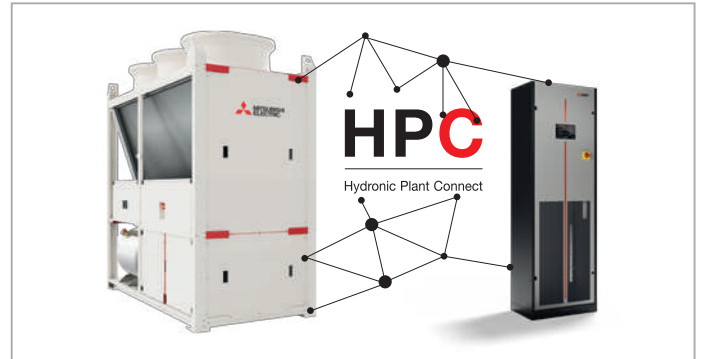

Main options

Energy Meter for BMS Energy Meter for W3000+	Acquires the electrical data and the power absorbed by the unit. Data is sent to the BMS or directly readable on the unit keyboard.
Thermal Energy Meter	Evaluates the cooling/heating capacity delivered by the unit.
External Capacity Cap	This option controls the maximum capacity output of the unit and it's ideal for full inverter or hybrid units.
Hydrophilic Treatment	Source side heat exchanger treatment that allows water droplets to flow off the surface (MEHP-iS-G07 only).
Hydronic Kits	Low or high head, fixed or variable speed, single or twin pumps and buffer tank always integrated in the unit.
Auxiliary Source and DHW Management	Functions for plants requiring the production of DHW in a storage tank. (MEHP-iS-G07 only).
Multifunction Card	Night mode, hydraulic decoupler probe for pump activation and User Limit Control Function.
Modular Installation Kit	Two modules of the same size can be connected thanks to a dedicated kit: <ul style="list-style-type: none"> • structural and mechanical connection for reinforcement and safety • hydraulic connections • a software connection through multi-unit multi manager control

Simplified operations during installation, commissioning and service of the units

Thanks to an accurate design it was possible to include with meticulous detail every mechanical and electrical component for an easier and more effective maintenance.

EASY AND EFFECTIVE MAINTENANCE OPERATIONS

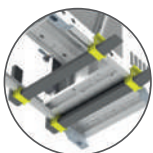
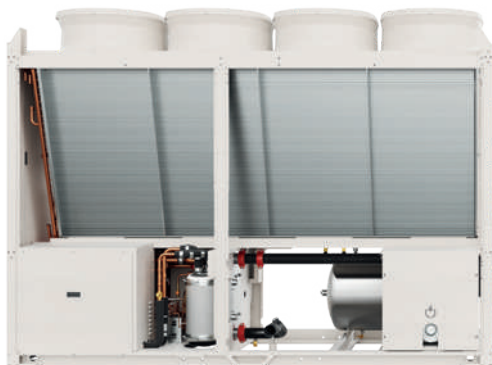

Forklift brackets for lateral handling of the units



Extremely easy power cable connection thanks to the precise design of the structure with the front entrance or from the basement of the unit and a convenient direct connection to the electrical connectors

In and out hydraulic connections label directly printed on the metal frame



The electrical power panel is separated from the electrical control panel and from the compressor and fans drivers box

EASY AND EFFECTIVE MAINTENANCE OPERATIONS



Hinged speed drivers boxes for an easier access to each internal component



Easy access to the service points



Quick electrical couplings for fans

Huge benefits for every kind of application

Comfort applications

- Top-level performance at partial loads
- Extremely silent and compact unit
- Large operating map down to -20 C of outdoor air temperature; up to 65 C of hot water production in heat pump mode
- Plug & Play solution, thanks to integrated pumps kit + buffer tank
- Domestic Hot Water production (for MEHP-iS-G07)
- Optimized for heating mode (MEHP-iS-G07)

Process Applications

- Large operating map down to -12 C of evaporator leaving water temperature and down to -20 C of outdoor air temperature
- Extremely high reliability components
- Fully accessible service points for an easier maintenance
- Refrigerant leak detection options available
- Several coil solutions including e-coated microchannel, Cu/Al, pre-painted fins, fin guard silver and hydrophilic treatments (for MEHP-iS-G07)

IT Cooling applications

- MECH-iS-G07 combined with w-MEXT creates a complete Mitsubishi Electric System ideal for small and medium data centers
- High leaving water temperature up to 24 C
- LAN functions with up to 8 units
- HPC software for optimizing the entire chillers + CRAHs systems
- Wide option availability ideal for this kind of application (demand limit, external capacity cap, thermal energy meter)

Factory acceptance

Factory acceptance test experience

Test your heat pump before installation and make sure its performance is totally reliable.

Factory acceptance test

Factory Acceptance Test is available as additional service in order to test the unit under specific conditions.

Carried out within modern and sophisticated facilities, this service gives the customer the possibility to choose among different test options in order to:

- Verify unit operation under severe conditions
- Check performance, both at full and partial loads
- Test the unit with low outdoor air temperature operation
- Detect sound emissions
- Time the fast restart





GENERAL TECHNICAL DATA									
MECH-IS-G07			0051	0061	0071	0082	0092	0102	0112
Power supply	(4)	V/ph/Hz	400/3/50	400/3/50	400/3/50	400/3/50	400/3/50	400/3/50	400/3/50
PERFORMANCE									
COOLING ONLY (GROSS VALUE)									
Cooling capacity	(1)	kW	50,09	60,11	70,14	80,14	90,23	100,2	110,2
Total power input	(1)	kW	15,16	19,13	26,89	26,24	32,57	31,43	37,90
EER	(1)	kW/kW	3,296	3,147	2,606	3,057	2,767	3,191	2,908
COOLING ONLY (EN14511 VALUE)									
Cooling capacity	(1)(4)	kW	50,00	60,00	70,00	80,00	90,00	100,00	110,00
EER	(1)(4)	kW/kW	3,280	3,110	2,580	3,020	2,740	3,150	2,870
COOLING WITH PARTIAL RECOVERY									
Cooling capacity	(5)	kW	51,97	62,36	72,77	83,15	93,61	104,00	114,30
Total power input	(5)	kW	14,66	18,50	25,99	25,37	31,48	30,39	36,64
Desuperheater heating capacity	(5)	kW	12,68	16,19	23,11	22,16	27,82	26,37	32,15
EXCHANGERS									
HEAT EXCHANGER USER SIDE IN COOLING									
Water flow	(1)	l/s	2,395	2,874	3,354	3,833	4,315	4,792	5,270
Pressure drop at the heat exchanger	(1)(4)	kPa	15,6	22,5	30,6	23,6	29,9	28,3	34,2
PARTIAL RECOVERY USER SIDE IN REFRIGERATION									
Water flow	(1)	l/s	0,612	0,781	1,116	1,070	1,343	1,273	1,552
Pressure drop at the heat exchanger	(1)	kPa	8,57	14,0	28,5	12,9	20,4	12,9	19,1
PERFORMANCE									
COOLING ONLY (GROSS VALUE)									
16°C/10°C									
Cooling capacity	(2)	kW	54,69	65,32	75,82	87,60	98,20	109,4	120,1
Total power input	(2)	kW	15,47	19,61	27,69	26,82	33,41	32,06	38,73
EER	(2)	kW/kW	3,529	3,332	2,736	3,269	2,940	3,408	3,103
23°C/15°C									
Cooling capacity	(3)	kW	62,37	73,93	85,00	100,1	111,5	124,7	136,4
Total power input	(3)	kW	15,86	20,25	28,85	27,55	34,52	32,81	39,78
EER	(3)	kW/kW	3,925	3,640	2,941	3,640	3,232	3,802	3,427
EXCHANGERS									
16°C/10°C									
Water flow	(2)	l/s	2,181	2,605	3,024	3,494	3,917	4,362	4,788
Pressure drop at the heat exchanger	(2)	kPa	12,9	18,5	24,9	19,6	24,7	23,4	28,2
23°C/15°C									
Water flow	(3)	l/s	1,868	2,215	2,546	2,999	3,339	3,735	4,086
Pressure drop at the heat exchanger	(3)	kPa	9,50	13,3	17,6	14,5	17,9	17,2	20,6
REFRIGERANT CIRCUIT									
Compressors nr.		N°	1	1	1	2	2	2	2
Number of capacity steps		N°	0	0	0	0	0	0	0
No. Circuits		N°	1	1	1	1	1	1	1
Regulation			Stepless	Stepless	Stepless	Stepless	Stepless	Stepless	Stepless
Min. capacity step		%	27	27	27	22	22	20	20
Refrigerant			R32	R32	R32	R32	R32	R32	R32
Theoretical refrigerant charge		kg	8,00	8,00	8,00	11,0	11,0	13,0	13,0
Oil charge		kg	3,50	3,50	3,50	7,00	7,00	7,00	7,00
Rc (ASHRAE)	(6)	kg/kW	0,16	0,13	0,12	0,14	0,12	0,13	0,12
FANS									
Quantity		N°	2	2	2	3	3	4	4
Air flow		m³/s	6,86	7,01	7,01	9,84	9,84	12,97	12,97
Total fans power input		kW	0,96	1,00	1,00	1,41	1,41	1,88	1,88
NOISE LEVEL									
Total sound Pressure	(7)	dB(A)	45	46	48	48	49	50	50
Total sound power level in cooling	(8)(9)	dB(A)	77	78	80	80	81	82	82
SIZE AND WEIGHT									
A	(10)	mm	2085	2085	2085	2600	2600	3225	3225
B	(10)	mm	1100	1100	1100	1100	1100	1100	1100
H	(10)	mm	2400	2400	2400	2400	2400	2400	2400
Operating weight	(10)	kg	630	630	630	830	830	940	940

Notes:
 1 Plant (side) cooling exchanger water (in/out) 12,00°C/7,00°C; Source (side) heat exchanger air (in) 35,0°C.
 2 Plant (side) cooling exchanger water (in/out) 16,00°C/10,00°C; Source (side) heat exchanger air (in) 35,0°C.
 3 Plant (side) cooling exchanger water (in/out) 23,00°C/15,00°C; Source (side) heat exchanger air (in) 35,0°C.
 4 Values in compliance with EN14511
 5 Plant (side) cooling exchanger water (in/out) 12,00°C/7,00°C; Source (side) heat exchanger air (in) 35,0°C; Plant (side) heat exchanger recovery water (in/out) 40,00°C/45,00°C.
 6 Rated in accordance with AHRI Standard 550/590
 7 Average sound pressure level at 10m distance, unit in a free field on a reflective surface; non-binding value calculated from the sound power level.
 8 Sound power on the basis of measurements taken in compliance with ISO 9614.
 9 Sound power level in cooling, outdoors.
 10 Unit in standard configuration, without optional accessories.

TECHNICAL DATA SEASONAL EFFICIENCY IN COOLING (EN14825 VALUE)

MECH-iS-G07	0051	0061	0071	0082	0092	0102	0112
-------------	------	------	------	------	------	------	------

SEASONAL EFFICIENCY IN COOLING (REG. EU 2016/2281) AMBIENT REFRIGERATION

Prated,c	(1)	kW	50,0	60,	70,0	80,0	90,0	100,0	110,0
SEER	(1)(2)	-	5,29	5,28	4,98	5,15	5,12	5,32	5,29
Performance ηs	(1)(3)	%	209,0	208,0	196,0	203,0	202,0	210,0	209,0

Notes:
 (1) Parameter calculated according to [REGULATION (EU) N. 2016/2281]
 (2) Seasonal energy efficiency ratio
 (3) Seasonal space cooling energy efficiency
 The units highlighted in this publication contain R32 [GWP100 677] fluorinated greenhouse gases.

TECHNICAL DATA SEASONAL EFFICIENCY IN COOLING (EN14825 VALUE)

MECH-iS-G07	0051	0061	0071	0082	0092	0102	0112
-------------	------	------	------	------	------	------	------

SEASONAL EFFICIENCY IN COOLING (REG. EU 2016/2281) HIGH TEMPERATURE PROCESS COOLING

Prated,c	(1)	kW	50,0	60,0	70,0	80,0	90,0	100,0	110,0
SEPR HT	(1)(3)	-	6,29	5,96	5,18	6,27	6,04	5,98	5,89

Notes:
 1 Seasonal energy efficiency of high temperature process cooling [REGULATION (EU) N. 813/2013]
 3 Seasonal space cooling energy efficiency

OPERATING LIMITS - GRAPHS

COOLING MODE

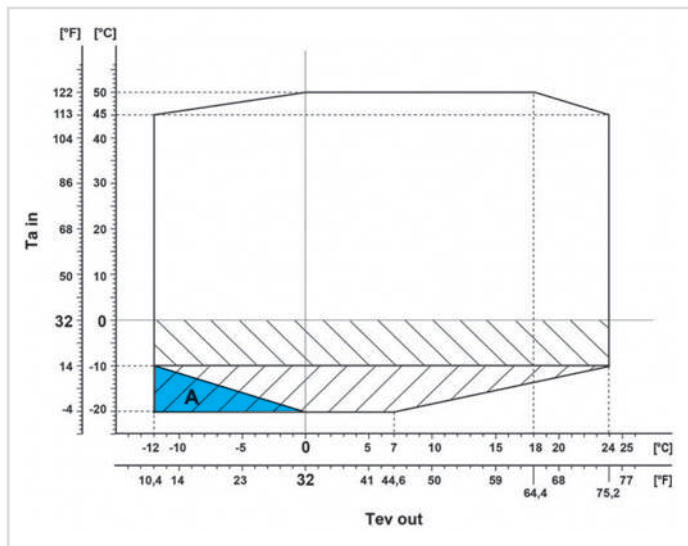

- Ta in** Outdoor air temperature
- Tev out** Evaporator leaving water temperature
- Required: Antifreeze heaters on pipes (opt. 2431) Antifreeze heaters on pipes, pumps*, and buffer tank* (opt. 2432 or 2433) *if present.
- Required: Antifreeze heaters on pipes (opt. 2431) Antifreeze heaters on pipes, pumps*, and buffer tank* (opt. 2432 or 2433) *if present. Extra insulation on heat exchangers (opt. 2641)
- A** Operation between -10 °C / 14 °F and -20 °C / -4 °F of outdoor air temperature is allowed for wind protected installations (wind speed lower than 2 m/s - 6,56 ft/s)

In particular operating conditions the unit can work with forced ventilation, at partial loads or with derating compressors. For any specific information please refer to the ElcaWorld software selection.

For the specific temperature limits of each model please refer to the selection software ElcaWorld.

COOLING MODE /D VERSION

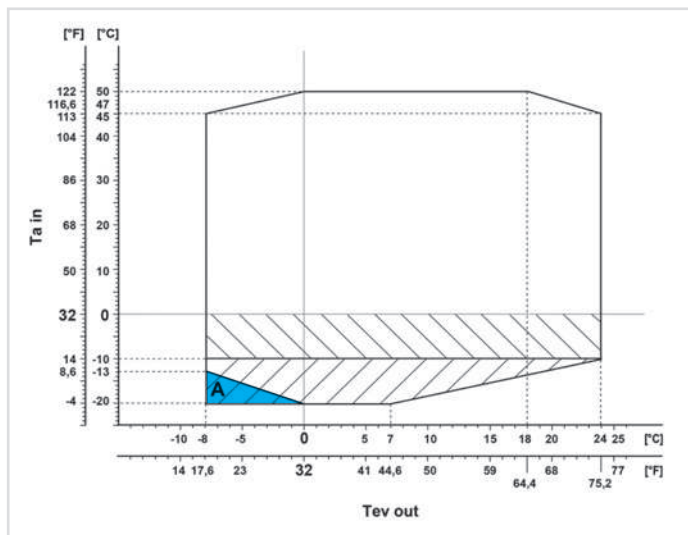

- Ta in** Outdoor air temperature
- Tev out** Evaporator leaving water temperature
- Required: Antifreeze heaters on pipes (opt. 2431) Antifreeze heaters on pipes, pumps*, and buffer tank* (opt. 2432 or 2433) *if present.
- Required: Antifreeze heaters on pipes (opt. 2431) Antifreeze heaters on pipes, pumps*, and buffer tank* (opt. 2432 or 2433) *if present. Extra insulation on heat exchangers (opt. 2641)
- A** Operation between -10 °C / 14 °F and -20 °C / -4 °F of outdoor air temperature is allowed for wind protected installations (wind speed lower than 2 m/s - 6,56 ft/s)

In particular operating conditions the unit can work with forced ventilation, at partial loads or with derating compressors. For any specific information please refer to the ElcaWorld software selection.

For the specific temperature limits of each model please refer to the selection software ElcaWorld.

GENERAL TECHNICAL DATA									
MEHP-IS-G07		0051	0061	0071	0082	0092	0102	0112	
Power supply	⁽¹⁾ V/ph/Hz	400/3/50	400/3/50	400/3/50	400/3/50	400/3/50	400/3/50	400/3/50	
PERFORMANCE									
COOLING ONLY (GROSS VALUE)									
Cooling capacity	⁽¹⁾ kW	48,10	53,11	60,09	68,39	74,18	85,99	93,98	
Total power input	⁽¹⁾ kW	17,00	19,95	25,48	24,91	30,10	31,86	37,61	
EER	⁽¹⁾ kW/kW	2,829	2,668	2,357	2,747	2,465	2,696	2,500	
COOLING ONLY (EN14511 VALUE)									
Cooling capacity	⁽¹⁾⁽²⁾ kW	48,00	53,00	60,00	68,30	74,10	85,90	93,80	
EER	⁽¹⁾⁽²⁾ kW/kW	2,810	2,640	2,340	2,730	2,450	2,680	2,480	
HEATING ONLY (GROSS VALUE)									
Total heating capacity	⁽³⁾ kW	49,92	59,86	69,87	79,89	89,85	100,1	110,0	
Total power input	⁽³⁾ kW	14,39	17,65	21,98	23,95	28,53	29,65	34,19	
COP	⁽³⁾ kW/kW	3,465	3,403	3,177	3,343	3,151	3,382	3,216	
HEATING ONLY (EN14511 VALUE)									
Total heating capacity	⁽³⁾⁽²⁾ kW	50,00	60,00	70,00	80,00	90,00	100,3	110,3	
COP	⁽³⁾⁽²⁾ kW/kW	3,440	3,380	3,150	3,320	3,120	3,350	3,180	
COOLING WITH PARTIAL RECOVERY									
Cooling capacity	⁽⁴⁾ kW	49,90	55,10	62,34	70,95	76,96	89,22	97,50	
Total power input	⁽⁴⁾ kW	16,44	19,28	24,62	24,09	29,10	30,81	36,36	
Desuperheater heating capacity	⁽⁴⁾ kW	14,39	17,02	21,96	20,98	25,61	26,76	31,89	
EXCHANGERS									
HEAT EXCHANGER USER SIDE IN COOLING									
Water flow	⁽¹⁾ l/s	2,300	2,540	2,874	3,270	3,547	4,112	4,494	
Pressure drop at the heat exchanger	⁽¹⁾ kPa	14,4	17,6	22,5	17,2	20,2	20,8	24,9	
HEAT EXCHANGER USER SIDE IN HEATING									
Water flow	⁽³⁾ l/s	2,410	2,889	3,373	3,856	4,337	4,832	5,311	
Pressure drop at the heat exchanger	⁽³⁾ kPa	15,8	22,7	31,0	23,9	30,2	28,7	34,7	
PARTIAL RECOVERY USER SIDE IN REFRIGERATION									
Water flow	⁽⁴⁾ l/s	0,695	0,822	1,060	1,012	1,236	1,292	1,539	
Pressure drop at the heat exchanger	⁽⁴⁾ kPa	11,1	15,5	25,7	11,6	17,3	13,3	18,8	
REFRIGERANT CIRCUIT									
Compressors nr.	N°	1	1	1	2	2	2	2	
Number of capacity steps	N°	0	0	0	0	0	0	0	
No. Circuits	N°	1	1	1	1	1	1	1	
Regulation		Stepless	Stepless	Stepless	Stepless	Stepless	Stepless	Stepless	
Min. capacity step	%	27	27	27	22	22	20	20	
Refrigerant		R32	R32	R32	R32	R32	R32	R32	
Theoretical refrigerant charge	kg	12,0	12,0	12,0	18,0	18,0	25,0	25,0	
Oil charge	kg	3,50	3,50	3,50	7,00	7,00	7,00	7,00	
Rc (ASHRAE)	⁽⁵⁾ kg/kW	0,25	0,23	0,20	0,27	0,24	0,29	0,27	
FANS									
Quantity	N°	2	2	2	3	3	4	4	
Air flow	m³/s	5,89	5,89	5,89	8,89	8,89	11,77	11,77	
Total fans power input	kW	0,88	0,88	0,88	1,41	1,41	1,88	1,88	
NOISE LEVEL									
Total sound Pressure	⁽⁶⁾ dB(A)	59	60	62	62	63	63	63	
Total sound power level in cooling	⁽⁷⁾⁽⁸⁾ dB(A)	77	78	80	80	81	82	82	
Total sound power level in heating	⁽⁷⁾⁽⁹⁾ dB(A)	77	78	80	80	81	82	82	
SIZE AND WEIGHT									
A	⁽¹⁰⁾ mm	2085	2085	2085	2600	2600	3225	3225	
B	⁽¹⁰⁾ mm	1100	1100	1100	1100	1100	1100	1100	
H	⁽¹⁰⁾ mm	2400	2400	2400	2400	2400	2400	2400	
Operating weight	⁽¹⁰⁾ kg	710	710	710	960	960	1085	1085	

- Notes:
- Plant (side) cooling exchanger water (in/out) 12,00°C/7,00°C; Source (side) heat exchanger air (in) 35,0°C.
 - Values in compliance with EN14511
 - Plant (side) heat exchanger water (in/out) 40,00°C/45,00°C; Source (side) heat exchanger air (in) 7,0°C - 87% R.H.
 - Plant (side) cooling exchanger water (in/out) 12,00°C/7,00°C; Source (side) heat exchanger air (in) 35,0°C; Plant (side) heat exchanger recovery water (in/out) 40,00°C/45,00°C.
 - Rated in accordance with AHRI Standard 550/590
 - Average sound pressure level at 1m distance, unit in a free field on a reflective surface; non-binding value calculated from the sound power level.
 - Sound power on the basis of measurements taken in compliance with ISO 9614.
 - Sound power level in cooling, outdoors.
 - Sound power level in heating, outdoors.
 - Unit in standard configuration, without optional accessories.

TECHNICAL DATA SEASONAL EFFICIENCY IN HEATING (EN14825 VALUE) - LOW TEMPERATURE APPLICATION									
MEHP-IS-G07		0051	0061	0071	0082	0092	0102	0112	
Power supply	(1)	V/ph/Hz	400/3/50	400/3/50	400/3/50	400/3/50	400/3/50	400/3/50	400/3/50
WEATHER CONDITIONS - AVERAGE									
Rated heat output at Tdesignh	(1)(2)	kW	40	48	55	64	72	80	89
Bivalent temperature	(1)(2)	°C	-7	-7	-7	-7	-7	-7	-7
SCOP	(1)(2)		4,39	4,33	4,34	4,35	4,12	4,30	4,32
Seasonal space heating energy efficiency	(1)(2)	%	172	170	171	171	162	169	170
Seasonal space heating energy efficiency class	(1)(2)		A++	A++	A++	A++	A++	-	-

Notes:
 1 Seasonal space heating energy efficiency class MEDIUM TEMPERATURE [REGULATION (EU) N. 813/2013]
 2 Type of calculation with variable flow and variable temperature.

TECHNICAL DATA SEASONAL EFFICIENCY IN HEATING (EN14825 VALUE) - MEDIUM TEMPERATURE APPLICATION									
MEHP-IS-G07		0051	0061	0071	0082	0092	0102	0112	
Power supply	(1)	V/ph/Hz	400/3/50	400/3/50	400/3/50	400/3/50	400/3/50	400/3/50	400/3/50
WEATHER CONDITIONS - AVERAGE									
Rated heat output at Tdesignh	(1)(2)	kW	40	48	48	64	64	82	82
Bivalent temperature	(1)(2)	°C	-7	-7	-7	-7	-7	-7	-7
SCOP	(1)(2)		3,43	3,37	3,37	3,37	3,23	3,39	3,43
Seasonal space heating energy efficiency	(1)(2)	%	134	132	132	132	126	133	134
Seasonal space heating energy efficiency class	(1)(2)		A++	A++	A++	A++	A++	-	-

Notes:
 1 Seasonal space heating energy efficiency class LOW TEMPERATURE [REGULATION (EU) N. 813/2013]
 2 Type of calculation with variable flow and variable temperature.

TECHNICAL DATA SEASONAL EFFICIENCY IN COOLING (EN14825 VALUE)									
MEHP-IS-G07		0051	0061	0071	0082	0092	0102	0112	
Prated,c	(1)	kW	48,0	53,0	60,0	68,3	74,1	85,9	93,8
SEER	(1)(2)	-	4,63	4,58	4,46	4,49	4,46	4,81	4,75
Performance ηs	(1)(3)	%	182,0	180,0	175,0	177,0	175,0	189,0	187,0

Notes:
 1 Seasonal space heating energy efficiency class LOW TEMPERATURE [REGULATION (EU) N. 813/2013]
 2 Type of calculation with variable flow and variable temperature.

OPERATING LIMITS - GRAPHS

HEATING MODE

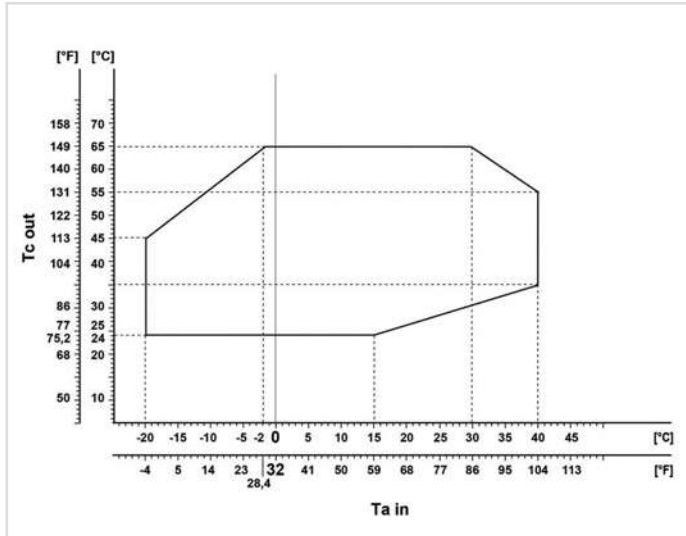

Ta in Outdoor air temperature
Tev out Condenser leaving water temperature

In particular operating conditions the unit can work with forced ventilation, at partial loads or with derating compressors. For any specific information please refer to the ElcaWorld software selection.

For the specific temperature limits of each model please refer to the selection software ElcaWorld.

COOLING MODE

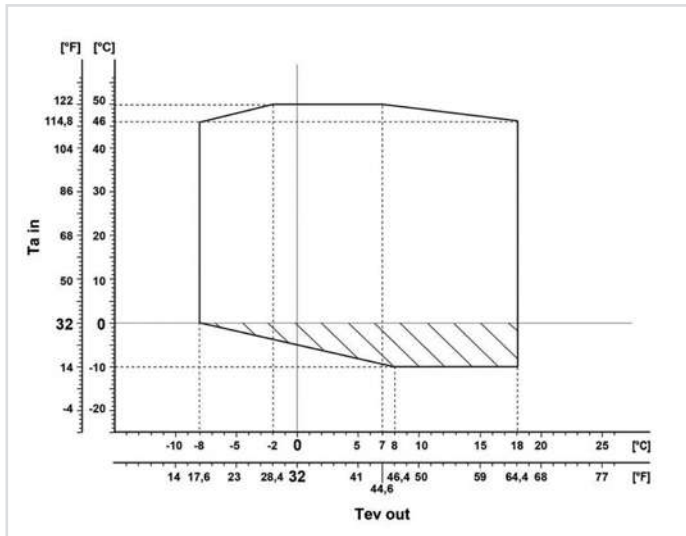

Ta in Outdoor air temperature
Tev out Evaporator leaving water temperature

 Required: Antifreeze heaters on pipes (opt. 2431)
 Antifreeze heaters on pipes, pumps*, and buffer tank* (opt. 2432 or 2433) *if present.

In particular operating conditions the unit can work with forced ventilation, at partial loads or with derating compressors. For any specific information please refer to the ElcaWorld software selection.

For the specific temperature limits of each model please refer to the selection software ElcaWorld.

COOLING MODE /ID VERSION

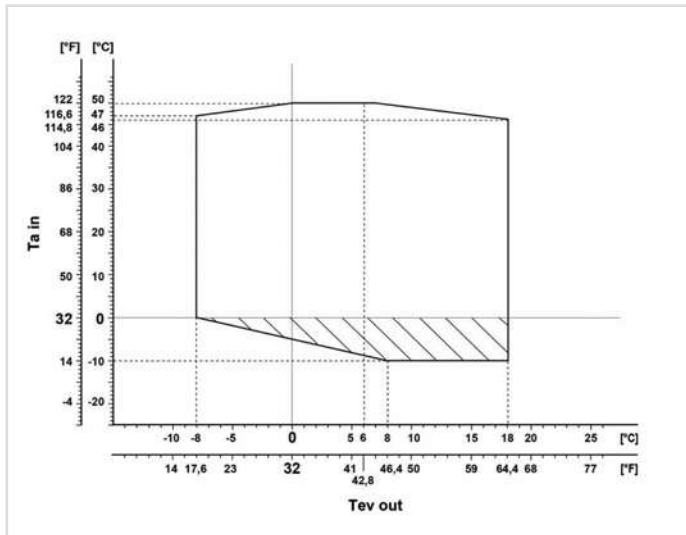

Ta in Outdoor air temperature
Tev out Evaporator leaving water temperature

 Required: Antifreeze heaters on pipes (opt. 2431)
 Antifreeze heaters on pipes, pumps*, and buffer tank* (opt. 2432 or 2433) *if present.

In particular operating conditions the unit can work with forced ventilation, at partial loads or with derating compressors. For any specific information please refer to the ElcaWorld software selection.

For the specific temperature limits of each model please refer to the selection software ElcaWorld.



EAC(H)V Line

ME-series **R32**

The EAC(H)V Line allows for up to six individual units to be connected together. Available as a cooling only or heat pump version, the EAC(H)V Line is suitable for both comfort, process and IT cooling applications.

Mitsubishi Electric's modular chiller line-up contributes to realizing high functionality, reliability and energy saving with its own control.

Three capacity modules with the side flow type of 90 kW, the top flow type of 150, 180 kW.

The 90kW model is equipped with R410A refrigerant, whereas the 150 and 180 kW models come with the R32 low GWP refrigerant.



A new generation of chiller technology

Mitsubishi Electric is the first name for comfort and efficiency.

Founded in 1921, Mitsubishi Electric is now a global, market leading environmental technologies manufacturer. In the worldwide market, the Living Environment Systems Division provides pioneering solutions that heat, cool, ventilate and control our buildings in some of the most energy efficient ways possible.

Through our technical expertise, long experience and innovative product range, we enable building operators everywhere to significantly improve energy efficiency, reduce running costs and adhere to increasingly tough legislation. We believe that global climate challenges need local solutions. There are number of challenges facing building owners and managers today, they must tackle ongoing requirements to reduce energy used in their buildings and their running costs, and our aim is to help them in achieving these goals.

At Mitsubishi Electric, we have evolved and today we offer advanced technology that really can make a world of difference.

Why chillers?

Today's building owners and managers face the challenge of providing a comfortable, productive space that is also energy efficient.

As the drive to reduce energy waste continues with further legislation, building services are being scrutinised to find more ways to optimise performance. Air conditioning is acknowledged as a significant energy user in buildings, therefore chillers can make a significant impact on the energy performance and running cost for many buildings. As manufacturers, we are being tasked with producing more efficient equipment and with enabling specifiers to compare products easily with regard to efficiency and performance.

In Commercial buildings HVAC accounts for 45% of total energy consumption

In commercial buildings, HVAC is by far the most energy intensive system, accounting for close to half of the total energy consumption. For this reason every efficiency improvement in HVAC performance can significantly reduce the energy profile of the building, turning HVAC optimisation into a value generating opportunity.

ErP Directive - Lot 21

The main impact of the ErP (Energy Related Products) Lot 21 will be on the way that chiller efficiency is measured. Ratings will be based on higher requirements for seasonal efficiency, and many older existing chillers will not comply. The ErP uses different performance parameters for different types of product to set the Minimum Energy Performance Standards (MEPS).

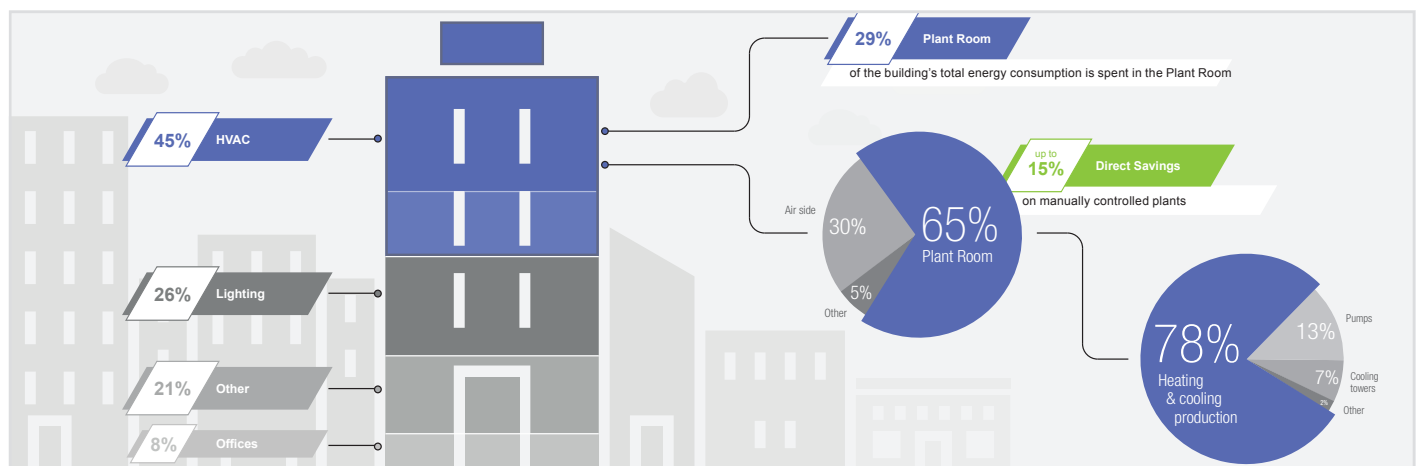

Source	Cooling Capacity	Minimum Efficiency	
		Jan 2018	Jan 2021
Air Cooled	<400kW	149%	161%
Air Cooled	≥400kW	161%	179%
Water Cooled	<400kW	196%	200%
Water Cooled	≥400kW ≤1500kW	227%	252%
Water Cooled	≥1500kW	245%	272%

The latest chiller technologies help to address the ERP Directive by ensuring that they operate to meet the precise cooling demand of the building, conserving energy usage within the building. The main components of water and air cooled chillers are very similar.

The way we use buildings today is changing, and the energy demands are changing with them. So now is a good time to consider the benefits of upgrading chiller plant.

With legislation pushing buildings towards greater energy efficiency and reducing carbon, and new regulations bringing even more efficient chiller options, such as heat recovery, to the market, specifiers have every reason to take a look at the benefits of a modern chiller for both new construction and retrofit scenarios.

The impact of a chiller on the comfort of occupants should also be considered. With a modern, robust technology in place, building owners can be assured that they are providing a comfortable and healthy environment, as well as saving themselves energy costs in the long-term.

Best in class efficiency for energy saving performance by the use of inverter compressors

- Inverter compressor is automatically controlled according the load.
- Optimal control of fans by using inverters contributes to save energy.

High functionality of modular chiller

- Up to 6 modules can be connected.
- The combination control of modules helps to continue operation even when one module has stopped due to maintenance.

Saving space and installation work

- Small footprint installation helps to save space.
- Built-in header type is optional, external piping space can be reduced.

Easy system control



- Water temperature can be controlled remotely by using local remote controllers.
- By installing an AE-200E/A, it is possible to centrally control e-series and CITY MULTI at the same time.



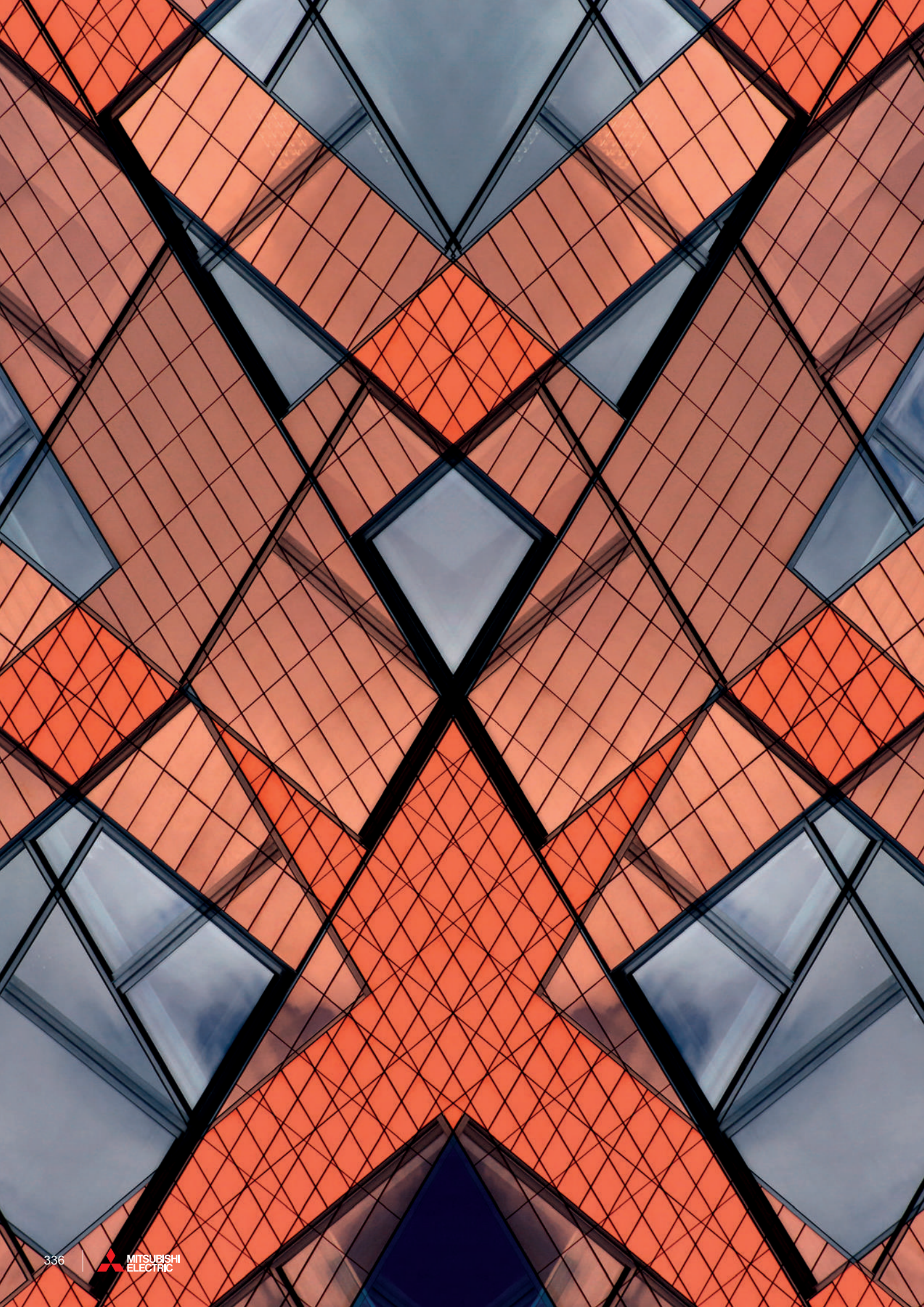



Module line-up

	90kW module*1	150kW module	180kW module
			
Heat Pump	EAHV-P900YAL(-N)(-BS)	EAHV-M1500YCL(-N)(-BS) R32	EAHV-M1800YCL(-N)(-BS) R32
	EAHV-P900YAF(-N)(-BS)		
Heating Only	EAHV-P900YAL-H(-N)(-BS)		
	EAHV-P900YAF-H(-N)(-BS)		
Cooling Only	EACV-P900YAL(-N)(-BS)	EACV-M1500YCL(-N)(-BS) R32	EACV-M1800YCL(-N)(-BS) R32
	EACV-P900YAF(-N)(-BS)		

*(-N) indicates model with built-in header.

*1The amount of pre-charged refrigerant differs among models. YAF indicates full refrigerant charging model.

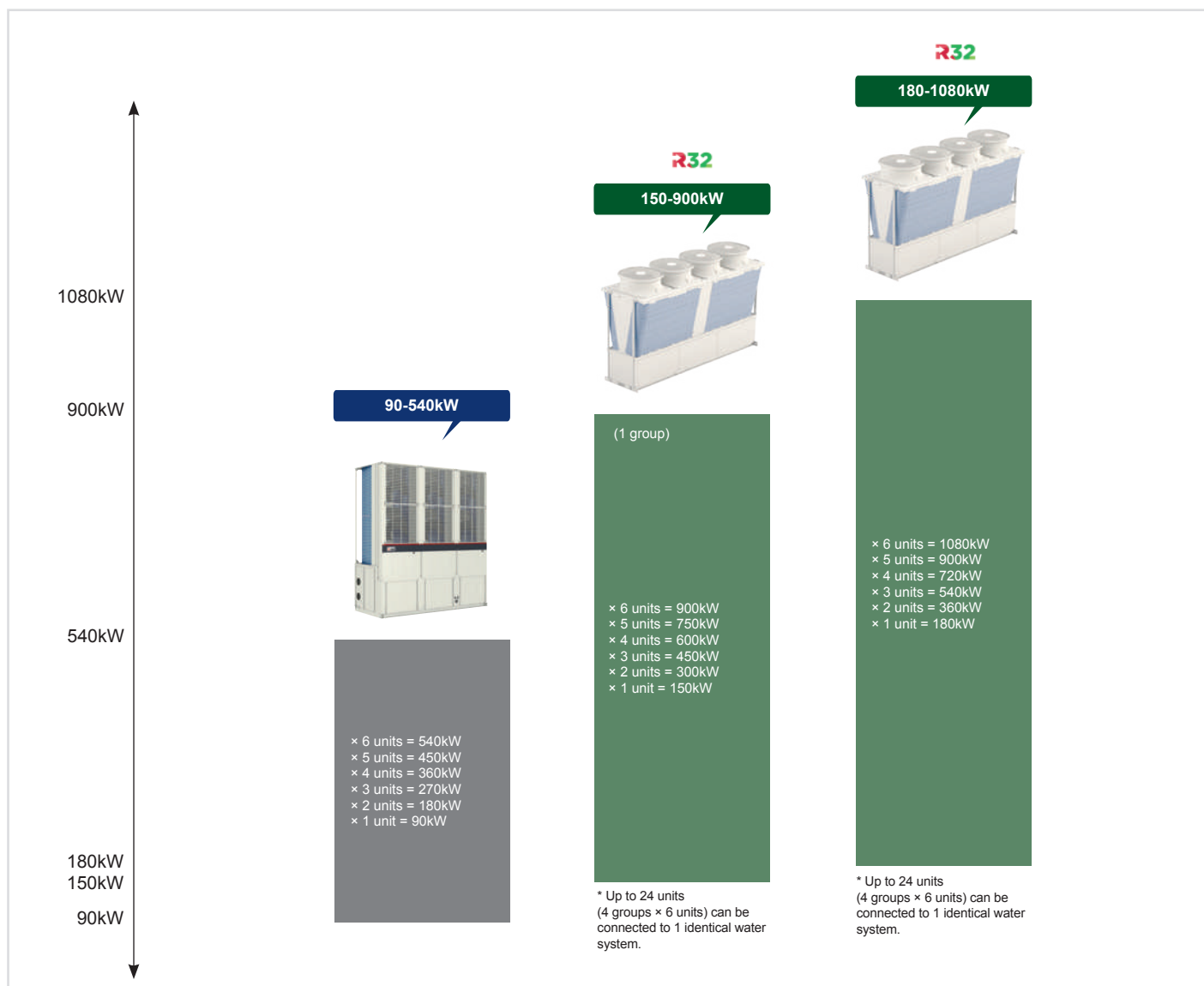

P900

R410A

ME-series

HIGH ENERGY SAVING
PERFORMANCE BY
THE USE OF INVERTER
COMPRESSORS

BEST IN CLASS
EFFICIENCY FOR ENERGY
SAVING PERFORMANCE

ENERGY-SAVING
TECHNOLOGY



UP TO 6 MODULES
CAN BE CONNECTED

COMBINATION
CONTROL FUNCTION

*LAST AVAILABILITY: DECEMBER 2024

High energy saving performance by the use of inverter compressors

Each module is provided with two high-efficiency inverter scroll compressors developed by Mitsubishi Electric and can operate optimally according to the load. This improves the high energy saving performance.

Best in class efficiency for energy saving performance

High EER, High COP

- The air suction area is expanded to maximize the performance of the air heat exchanger.
- Two independent refrigerant circuits are provided in the module to cool and heat water in two stages in series to improve EER and COP.

EER 3.30

COP 3.50

*EER shows the value at an outdoor air temperature of 35°C and cool water inlet/outlet temperatures of 12°C/7°C, respectively. COP shows the value at an outdoor air temperature of 7°C and hot water inlet/outlet temperatures of 40°C/45°C, respectively. Pump input is not included.

High SEER

- Achieved the same SEER from 30 to 180 HP.

SEER 4.48

* SEER shows the value at an outdoor air temperature of 35°C and cool water inlet/outlet temperatures of 12°C/7°C, respectively. Pump input is included based on EN14511.

Suppression of heating capacity drop at low outside temperatures

- A heat pump technology captures heat from the outdoor air. The heating performance decrease which occurs with a decrease in outdoor air temperature has been made up for by installing a larger number of units. This disadvantage has been eliminated with the e-series by increasing the heating performance in the low outdoor air temperature range. This allows the user to reduce the required number of units.

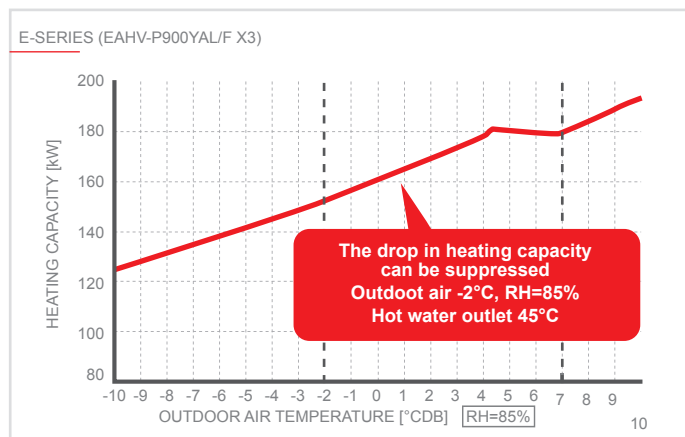

Energy-saving technology

High Efficiency Inverter Compressor

DC inverter scroll compressor is incorporated. Two compressors each are incorporated to increase efficiency.

Two refrigerating cycles

A configuration of two independent refrigerant circuits and the series connection of water-side heat exchangers increase the performance (two-stage cooling).

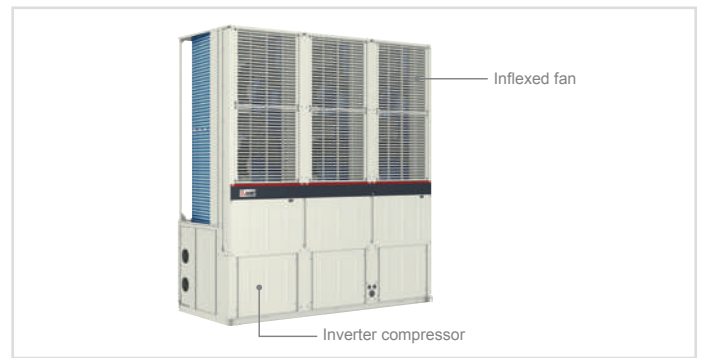

U-shaped High Performance Compact Air Heat Exchanger

U-shaped air heat exchangers are used. Installing them in a row makes the system thinner.

Weather resistant coating is provided for the heat transfer plate fin as standard.

Inflexed Fan

Adoption of a fan with improved ventilation characteristics and a newly designed trailing edge that suppresses wind turbulence raises fan operation efficiency.

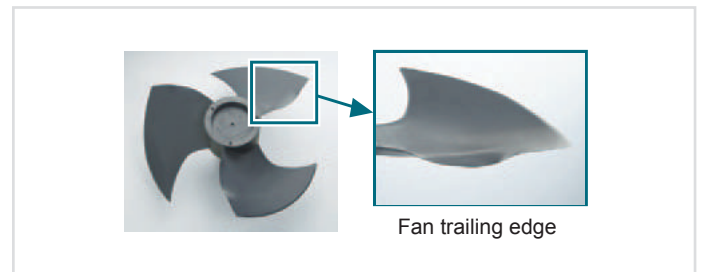

Fan Inverter Control

Air blower fans are also equipped with an inverter to save energy.

Up to 6 modules can be connected

The total capacity can be increased to up to 30HP × 6 modules = 180HP. Because modules can be installed horizontally in a row. Installation in narrow places such as along building walls is possible.

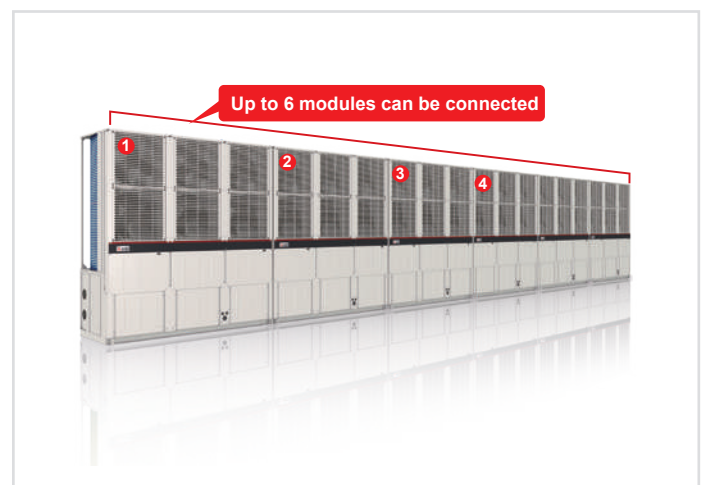

Combination control function

The flexible backup operation among the combined modules enables the continuous operation, even when one module is stopped due to maintenance.

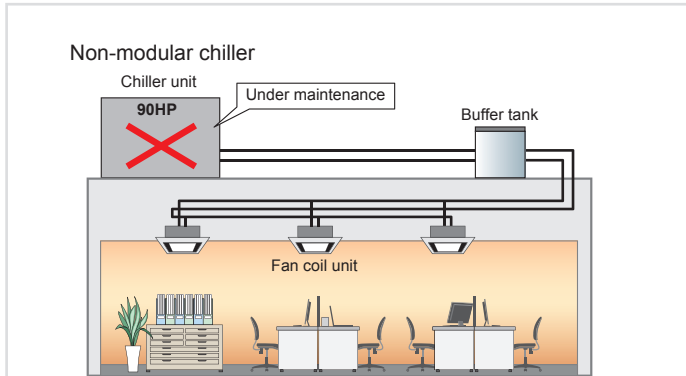

Since the chiller unit can not operate during maintenance, the timing of maintenance is limited.

Mitsubishi Electric modular chiller

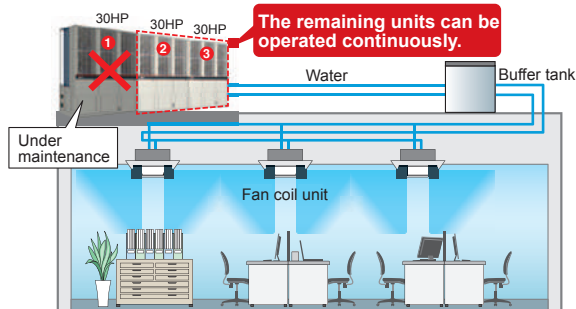

With our module chiller system, even if one module is stopped, the remaining modules back the continuous operation up.

* When performing maintenance, please confirm that the remaining modules

Small footprint installation

Since this module has a compact and thin body, it is suitable for installation along the exterior walls of buildings or in narrow spaces, and it is possible to install the modules on each floor.



Installation example

Installable in limited space, such as along the outer wall or in the corner of a factory, or in a narrow space of a building. The compact and thin design allows for the consideration of installation on each floor of a building, as is the case with industrial air conditioners. (If the inside header specification is selected).

The figure shows the air blowing surface directed toward the wall (a diagonal blowing air guide is equipped as standard). Directing the air blowing surface toward the wall is effective in preventing short cycling.

The modules can be installed in two rows or in one row on each of two stages using a frame. They can be installed flexibly according to the installation space.

EXAMPLE OF INSTALLATION ALONG THE OUTER WALL OF A FACTORY

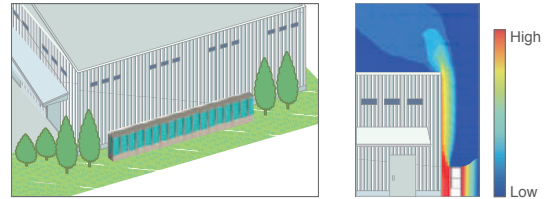

FRONT SURFACE-FACING DOUBLE-ROW INSTALLATION EXAMPLE

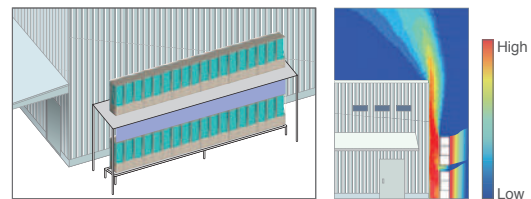

SINGLE-ROW DOUBLE-STACK INSTALLATION EXAMPLE

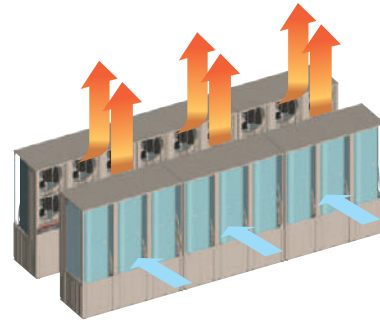

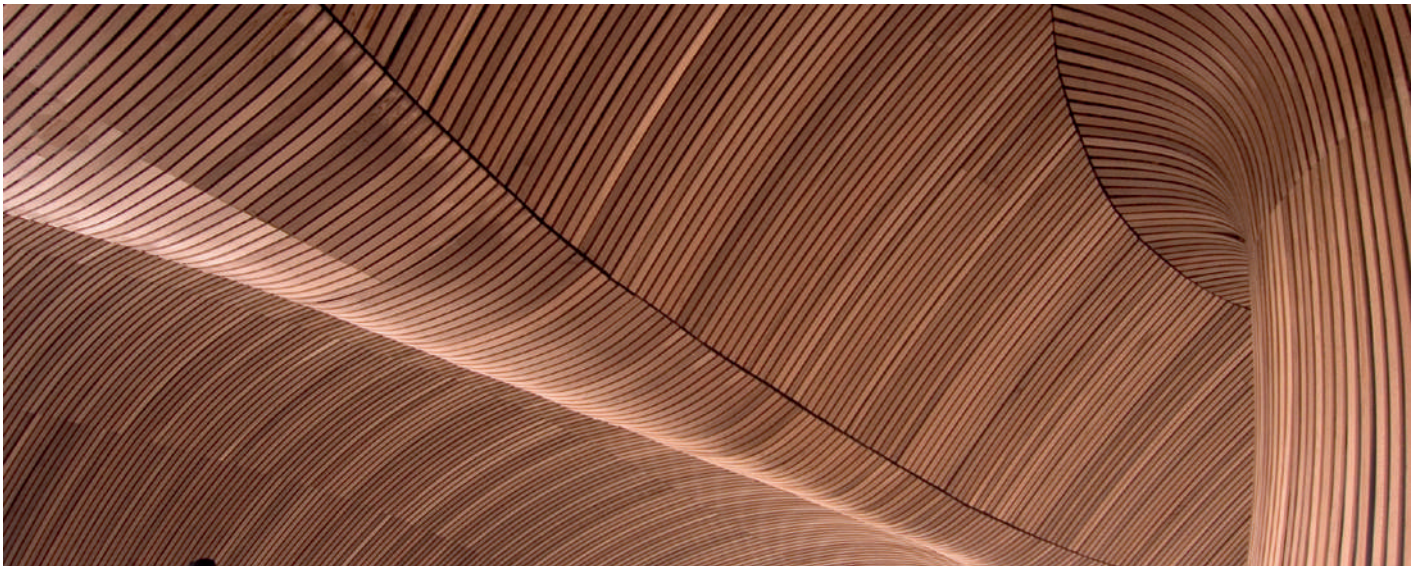

Inside Header

Mitsubishi Electric's Unique Inside Header Incorporates Field Water Pipe Header into Module

• The field water pipe header section that is usually required to connect the module to the field water pipe is now available as a manufacturer option (hereinafter referred to as the "inside header") which can be incorporated into the module at the factory before shipment (a supplied connection kit is used for the connection work at the customer's site).

• This allows for incorporating the field water pipe header section into the module.
 • In addition, the field connection work of the inside header is very simple. Significant simplification of the water pipe connection compared to the previous one has reduced the installation time.

Standard Pipe Specification

THE FIGURE SHOWS A 60 HP UNIT IN WHICH TWO 30 HP MODULES ARE CONNECTED

FIELD WATER PIPE HEADER CONNECTION IMAGE *1
(in the case of installing one pump for each module)

• Number of pumps: 6
 • Pipes connected at the site: 12 points

*1 Be sure to install a strainer (optional parts: YS-50A) near the chiller on the inlet side of the cool/hot water pipe to prevent the entry of foreign substances such as dirt and sand particles to the plate heat exchanger

Inside Header Specification

(Left or right connection can be selected for the water pipes)

THE FIGURE SHOWS A 60 HP UNIT IN WHICH TWO 30 HP MODULES ARE CONNECTED

FIELD WATER PIPE HEADER CONNECTION IMAGE *1
(in the case of installing one pump for the system)

• Number of pumps: 1
 • Pipes connected at the site: 2 points (10 internal connection points)

*1 Be sure to install a strainer near the chiller on the inlet side of the cool/hot water pipe to prevent the entry of foreign substances such as dirt and sand particles to the plate heat exchanger.

About Pipe Connection Kit

THIS FIGURE SHOWS 540 HP (EAHV-P900YAL/F-N×6) AS AN EXAMPLE.

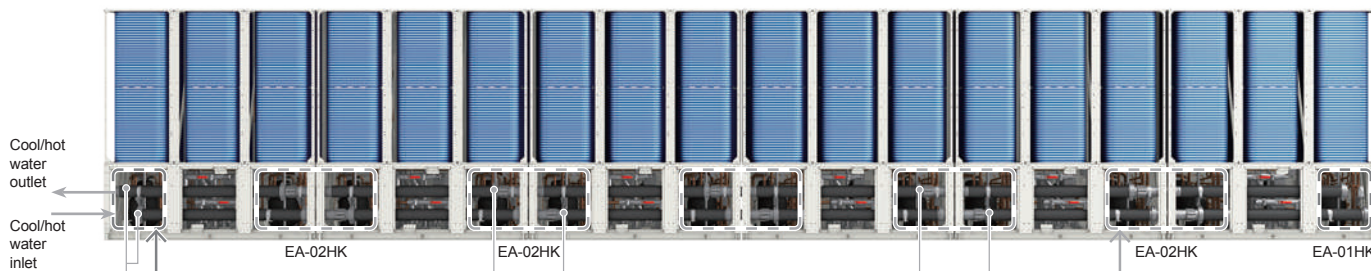

A Victaulic coupling is used to connect with the pipe at the customer's site (to be supplied in the field).
*Straub couplings and short pipes are included for the inside header specification

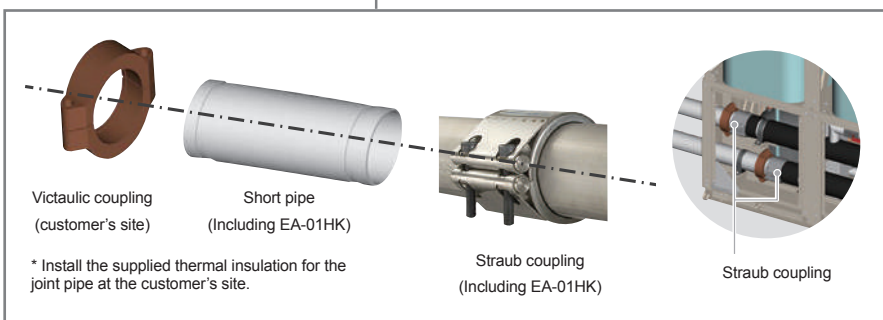

STRUCTURE

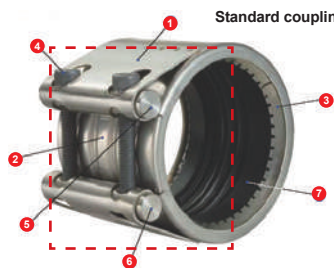

No.	Part name	Material
1	Casing	SUS 304
2	Sliding plate	SUS 301 or 304
3	Grip ring	SUS 301
4	Tightening bolt	SUS XM7
5	Rod washer	SUS 304
6	Rod nut	SUS 304
7	Rubber sleeve	EPDM

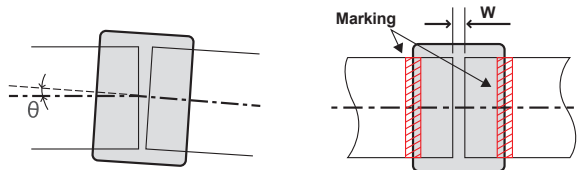

Allowable clearance and tilt range

Allowable pipe clearance value [W]=0 to 25 mm

Allowable pipe tilt angle [θ]=±2°

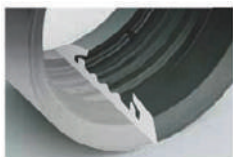

The sealed rubber has a lip structure to improve the water-stopping performance. Adjust the position of the Straub coupling so the marking on both sides can be seen.

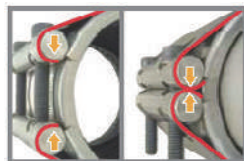

Just tighten the bolt until the casing fits against (comes into contact with) the metal. Anyone can connect the pipes evenly and securely, regardless of their skills and the type of the pipe used.

CONNECTING PIPE END (Connection at Customer's Site)

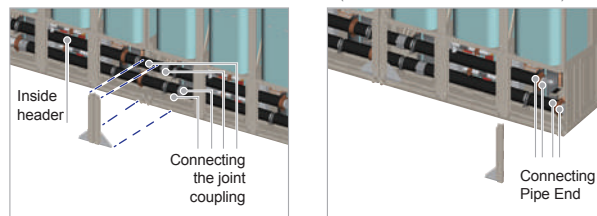

Capacity	Module (Inside header)	Optional parts -1- EA-01HK (model)	Optional parts -2- EA-02HK (model)
30 HP	1	1	0
60 HP (30 HP×2)	2	1	1
90 HP (30 HP×3)	3	1	2
120 HP (30 HP×4)	4	1	3
150 HP (30 HP×5)	5	1	4
180 HP (30 HP×6)	6	1	5

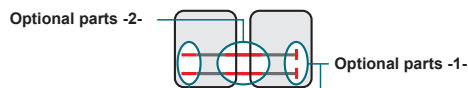
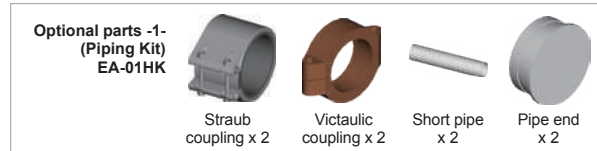

The Victaulic coupling and Straub coupling mentioned in the explanation are product names.

Control technology

- Up to 6 modules and one unit can be connected for each remote control.
- Simultaneous control

Unit Remote Control

 PAR-W31MAA	
Control	Simultaneous control
Number of modules that can be connected	6
Number of units that can be connected	1
Number of supported water lines	1
ON/OFF	•
Cooling/heating switch	•
FAN operation switch for snowfall	•
Target outlet temperature setting	•
Scheduled operation	•
Individual error display	•
Outlet water temperature setting of 5°C or below (Brine)	•

Centralized controller*

When connected to the AE-200E/A centralized controller or the EW-50A/E expansion controller, up to 6 e-series modules can be connected to 1 group for centralized monitoring and management. Combined management of CITY MULTI is also possible.

* Centralized monitoring and management are possible only for M-NET-connected e-series units.

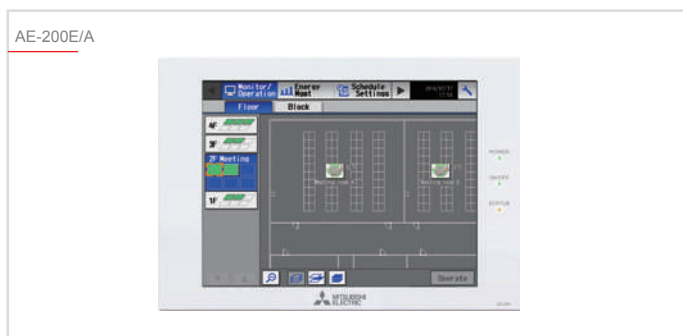

Monitoring on LCD touch panel and web browser

Monitoring of the operating condition—including the water temperature—of e-series units are possible from the LCD screen of the AE-200E/A or from a Web browser. Combined management of CITY MULTI is also possible.

System configuration

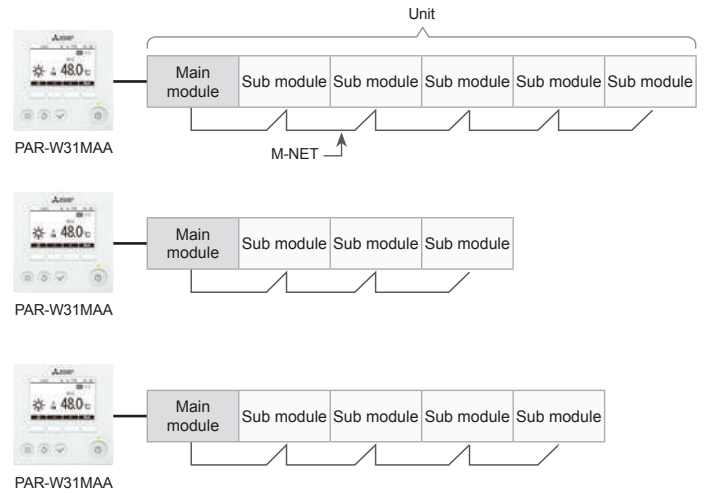

Demand control

Forced capacity control up to the demand upper limit by an external input to the unit (non-voltage normal open). Heating demand is possible in addition to the cooling demand.

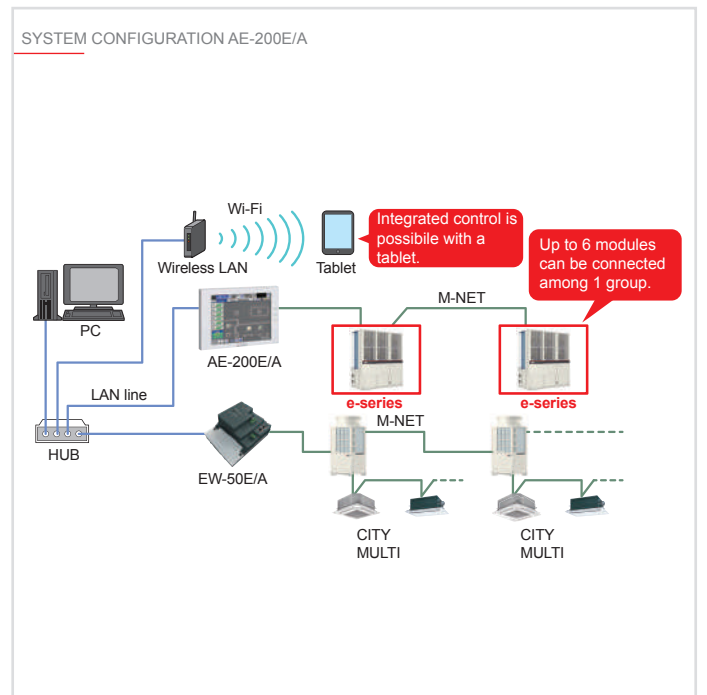

Technical specifications COOLING ONLY MODEL

MODEL		SET	EACV-P900YAL(-N)(-BS) EACV-P900YAF(-N)(-BS)	
Power source	3-phase 4-wire 380-400-415V 50/60Hz			
Capacity change mode			Capacity priority	COP priority
Cooling capacity *1 Water			kW	90.00
			kcal/h	77,400
			BTU/h	307,080
	Power input *2		kW	27.27
	Current input 380-400-415V	A	46.0 - 43.7 - 42.2	
	Pump input is not included	EER		3.30
		ESEER		5.66
	Certified value by EUROVENT	EER *3		3.08
		ESEER *3 *4		4.71
	ESEER (Includes pump input based on EN14511) *3 *5			5.46
SEER (Includes pump input based on EN14511) *3			4.88	
IPLV *6	kW/kW		6.34	
Water flow rate	m³/h		15.5	
Cooling capacity *7 *8 Brine(ethylene glycol 35wt%)			kW	56.73
			kcal/h	48,788
			BTU/h	193,563
	Power input *2		kW	25.98
	Current input 380-400-415V	A	43.9 - 41.7 - 40.2	
	EER(Pump input is not included)			2.18
	EER(Includes pump input based on EN14511) *3			2.10
	Brine flow rate	m³/h		11.5
Maximum current input	A		61	
Water pressure drop	Water *9	kPa	135	65
	Brine(ethylene glycol 35wt%) *8 *10	kPa	106	50
Temp range	Cooling	°C	Outlet water 5~25 *11	
	Water	°F	Outlet water 41~77 *11	
	Cooling	°C	Outlet brine -10~25 *8 *12	
	Brine(ethylene glycol 35wt%)	°F	Outlet brine 14~77 *8 *12	
	Outdoor	°C	-15~43 *11 *12	
	°F	5~109.4 *11 *12		
Circulating water volume range	m³/h		7.7~25.8	
Sound pressure level (measured in anechoic room) at 1m *1	dB (A)		65	63
Sound power level (measured in anechoic room) *1	dB (A)		77	75
Diameter of water pipe (Standard piping)	Inlet	mm (in)	50A (2B) housing type joint	
	Outlet	mm (in)	50A (2B) housing type joint	
Diameter of water pipe (Inside header piping)	Inlet	mm (in)	100A (4B) housing type joint	
	Outlet	mm (in)	100A (4B) housing type joint	
External finish	Polyester powder coating steel plate			
External dimension HxWxD	mm		2450 x 2250 x 900	
Net weight	Standard piping	kg (lbs)	957 (2110)	
	Inside header piping	kg (lbs)	992 (2187)	
Design pressure	R410A	MPa	4.15	
	Water	MPa	1.0	
Heat exchanger	Water side	Stainless steel plate and copper brazing		
	Air side	Plate fin and copper tube		
Compressor	Type	Inverter scroll hermetic compressor		
	Maker	MITSUBISHI ELECTRIC CORPORATION		
	Starting method	Inverter		
	Quantity	2		
	Motor output	kW	11.7 x 2	
	Case heater	kW	0.045 x 2	
	Lubricant	MEL32		
Fan	Air flow rate	m³/min	77 x 6	
		L/s	1283 x 6	
		cfm	2719 x 6	
	Type, Quantity	Propeller fan x 6		
	Starting method	Inverter		
Motor output	kW	0.19 x 6		
Protection	High pressure protection	High pres.Sensor & High pres.Switch at 4.15MPa (601psi)		
	Inverter circuit	Over-heat protection, Over current protection		
	Compressor	Over-heat protection		

*1 Under normal cooling conditions at outdoor temp 35°CDB/24°CWB (95°FDB/75.2°FWB) outlet water temp 7°C (44.6°F) inlet water temp 12°C (53.6°F).
 *2 Pump input is not included.
 *3 Pump is not included in e-series.
 *4 EN14511 standard (2013) formula is applied to figure out this value in case of fixed flow rate operation (flow rate is fixed at any heat load)
 Pump input is included in cooling capacity for EER calculation. Condition of water inlet and outlet is fixed at inlet 12°C and outlet 7°C.
 *5 EN14511 standard (2013) formula is applied to figure out this value in case of variable flow rate operation (flow rate varies per heat load).
 Pump input is included in cooling capacity for EER calculation. Condition of water temperature : inlet water temperature varies due to fixed water flow rate and outlet is fixed at outlet 7°C.
 *6 Calculations according to standard performances (in accordance with AHRI 550-590).
 *7 Under normal cooling conditions at outdoor temp 35°CDB/24°CWB (95°FDB/75.2°FWB) outlet brine temp -5°C (23.0°F) inlet brine temp 0°C (32.0°F).
 *8 Set the dipswitch SW3-6 on both main and sub modules to ON.
 *9 Under normal cooling conditions capacity 90kW, water flow rate 15.5m³/h
 *10 Under normal cooling conditions capacity 56.73kW, brine flow rate 11.5m³/h
 *Please don't use the steel material for the water piping.
 *Please always make water circulate, or pull the circulation water out completely when not in use.
 *Please do not use groundwater or well water in direct.
 *The water circuit must be closed circuit.
 *Due to continuous improvement, the above specifications may be subject to change without notice.

Technical specifications HEATPUMP MODEL

MODEL	SET	EAHV-P900YAL(-N)(-BS) EAHV-P900YAF(-N)(-BS)	
Power source		3-phase 4-wire 380-400-415V 50/60Hz	
Capacity change mode		Capacity priority	COP priority
Cooling capacity *1		kW	90.00
		kcal/h	77,400
		BTU/h	307,080
	Power input *3	kW	27.27
	Current input 380-400-415V	A	46.0 - 43.7 - 42.2
	Pump input is not included	EER	3.30
	Certified value by EUROVENT	EER *4	3.08
	SEER (Includes pump input based on EN14511) *4		4.88
	IPLV *8	kW/kW	6.34
	Water flow rate	m ³ /h	15.5
Heating capacity *2		kW	90.00
		kcal/h	77,400
		BTU/h	307,080
	Power input *3	kW	25.71
	Current input 380-400-415V	A	43.4 - 41.2 - 39.7
	COP (Pump input is not included)		3.50
	COP (Includes pump input based on EN14511) *4		3.25
	SCOP (Reversible) Low/Medium (Includes pump input based on EN14511) *4		3.66/2.89
	Seasonal space heating energy efficiency class for medium-temperature application		A+
	Seasonal space heating energy efficiency class for low-temperature application		A+
Water flow rate	m ³ /h	15.5	
Maximum current input	A	61	
Water pressure drop *5	kPa	135	65
Temp range	Cooling	°C	Outlet water 5~25 *9
		°F	Outlet water 41~77 *9
	Heating	°C	Outlet water 30~55 *9
		°F	Outlet water 86~131 *9
	Outdoor	°C	-15~43 *9
		°F	5~109.4 *9
Circulating water volume range	m ³ /h	7.7~25.8	
Sound pressure level (measured in anechoic room) at 1m *1	dB (A)	65	63
Sound power level (measured in anechoic room) *1	dB (A)	77	75
Diameter of water pipe (Standard piping)	Inlet	mm (in)	50A (2B) housing type joint
	Outlet	mm (in)	50A (2B) housing type joint
Diameter of water pipe (Inside header piping)	Inlet	mm (in)	100A (4B) housing type joint
	Outlet	mm (in)	100A (4B) housing type joint
External finish		Polyester powder coating steel plate	
External dimension HxWxD	mm	2450 x 2250 x 900	
Net weight	Standard piping	kg (lbs)	987 (2176)
	Inside header piping	kg (lbs)	1022 (2253)
Design pressure	Refrigerant	MPa	4.15
	Water	MPa	1.0
Heat exchanger	Water side		Stainless steel plate and copper brazing
	Air side		Plate fin and copper tube
Compressor	Type		Inverter scroll hermetic compressor
	Maker		MITSUBISHI ELECTRIC CORPORATION
	Starting method		Inverter
	Quantity		2
	Motor output	kW	11.7 x 2
	Case heater	kW	0.045 x 2
	Lubricant		MEL32
Fan	Air flow rate	m ³ /min	77 x 6
		L/s	1283 x 6
		cfm	2719 x 6
	Type, Quantity		Propeller fan x 6
	Starting method		Inverter
	Motor output	kW	0.19 x 6
Protection	High pressure protection		High pres.Sensor & High pres.Switch at 4.15MPa (601psi)
	Inverter circuit		Over-heat protection, Over current protection
	Compressor		Over-heat protection

*1 Under normal cooling conditions at outdoor temp 35°CDB/24°CWB (95°FDB/75.2°FWB) outlet water temp 7°C (44.6°F) inlet water temp 12°C (53.6°F).

*2 Under normal heating conditions at outdoor temp 7°CDB/6°CWB (44.6°FDB/42.8°FWB) outlet water temp 45°C (113°F) inlet water temp 40°C (104°F).

*3 Pump input is not included.

*4 Pump is not included in e-series.

*5 Under normal cooling or heating conditions capacity 90kW, water flow rate 15.5m³/h

*6 EN14511 standard (2013) formula is applied to figure out this value in case of fixed flow rate operation (flow rate is fixed at any heat load)

Pump input is included in cooling capacity for EER calculation. Condition of water inlet and outlet is fixed at inlet 12°C and outlet 7°C.

*7 EN14511 standard (2013) formula is applied to figure out this value in case of variable flow rate operation (flow rate varies per heat load). Pump input is included in cooling capacity for EER calculation.

Condition of water temperature : inlet water temperature varies due to fixed water flow rate and outlet is fixed at outlet 7°C.

*8 Calculations according to standard performances (in accordance with AHRI 550-590).

*Please don't use the steel material for the water piping.

*Please always make water circulate, or pull the circulation water out completely when not in use.

*Please do not use groundwater or well water in direct.

*The water circuit must be closed circuit.

*Due to continuous improvement, the above specifications may be subject to change without notice.

Technical specifications HEATING ONLY MODEL

MODEL		SET	EAHV-P900YAL-H(-N)(-BS) EAHV-P900YAF-H(-N)(-BS)	
Power source			3-phase 4-wire 380-400-415V 50/60Hz	
Capacity change mode			Capacity priority	COP priority
Heating capacity *1		kW	90.00	63.00
		kcal/h	77,400	54,180
		BTU/h	307,080	214,956
	Power input *2	kW	25.71	16.96
	Current input 380-400-415V	A	43.4 - 41.2 - 39.7	28.6 - 27.2 - 26.2
	COP (Pump input is not included)		3.50	3.71
	COP (Includes pump input based on EN14511) *3		3.25	3.61
	SCOP (Reversible) Low/Medium (Includes pump input based on EN14511) *4		3.56/2.83	-
	Seasonal space heating energy efficiency class for medium-temperature application		A+	-
	Seasonal space heating energy efficiency class for low-temperature application		A+	-
Water flow rate	m ³ /h	15.5	10.8	
Maximum current input	A	61		
Water pressure drop *5	kPa	135	65	
Temp range	Heating	°C	Outlet water 30~55 *6	
		°F	Outlet water 86~131 *6	
	Outdoor	°C	-15~43 *6	
		°F	5~109.4 *6	
Circulating water volume range	m ³ /h	7.7~25.8		
Sound pressure level (measured in anechoic room) at 1m *4	dB (A)	65	63	
Sound power level (measured in anechoic room) *4	dB (A)	77	75	
Diameter of water pipe (Standard piping)	Inlet	mm (in)	50A (2B) housing type joint	
	Outlet	mm (in)	50A (2B) housing type joint	
Diameter of water pipe (Inside header piping)	Inlet	mm (in)	100A (4B) housing type joint	
	Outlet	mm (in)	100A (4B) housing type joint	
External finish	Polyester powder coating steel plate			
External dimension HxWxD	mm	2450 x 2250 x 900		
Net weight	Standard piping	kg (lbs)	987 (2176)	
	Inside header piping	kg (lbs)	1022 (2253)	
Design pressure	Refrigerant	MPa	4.15	
	Water	MPa	1.0	
Heat exchanger	Water side	Stainless steel plate and copper brazing		
	Air side	Plate fin and copper tube		
Compressor	Type	Inverter scroll hermetic compressor		
	Maker	MITSUBISHI ELECTRIC CORPORATION		
	Starting method	Inverter		
	Quantity	2		
	Motor output	kW	11.7 x 2	
	Case heater	kW	0.045 x 2	
	Lubricant	MEL32		
Fan	Air flow rate	m ³ /min	77 x 6	
		L/s	1283 x 6	
		cfm	2719 x 6	
	Type, Quantity	Propeller fan x 6		
	Starting method	Inverter		
Motor output	kW	0.19 x 6		
Protection	High pressure protection	High pres. Sensor & High pres. Switch at 4.15MPa (601psi)		
	Inverter circuit	Over-heat protection, Over current protection		
	Compressor	Over-heat protection		

*1 Under normal heating conditions at outdoor temp 7°CDB/6°CWB (44.6°FDB/42.8°FWB) outlet water temp 45°C (113°F) inlet water temp 40°C (104°F).

*2 Pump input is not included.

*3 Pump is not included in e-series.

*4 Under normal heating conditions at outdoor temp 7°CDB/6°CWB (44.6°FDB/42.8°FWB) outlet water temp 45°C (113°F) inlet water temp 40°C (104°F).

*5 Under normal heating conditions capacity 90kW, water flow rate 15.5m³/h

*Please don't use the steel material for the water piping material.

*Please always make water circulate, or pull the circulation water out completely when not in use.

*Please do not use groundwater or well water in direct.

*The water circuit must be closed circuit.

*Due to continuous improvement, the above specifications may be subject to change without notice.

Operating limits

COOLING ONLY

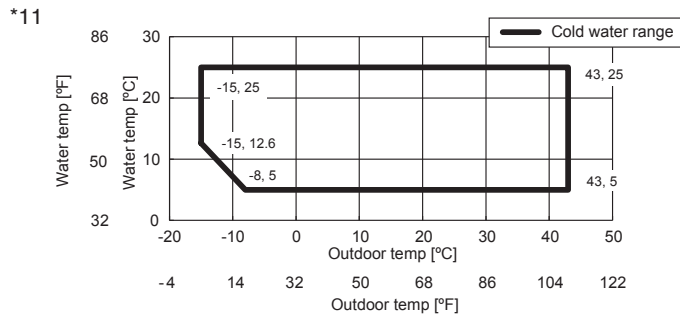

COOLING ONLY -
BRINE MODE

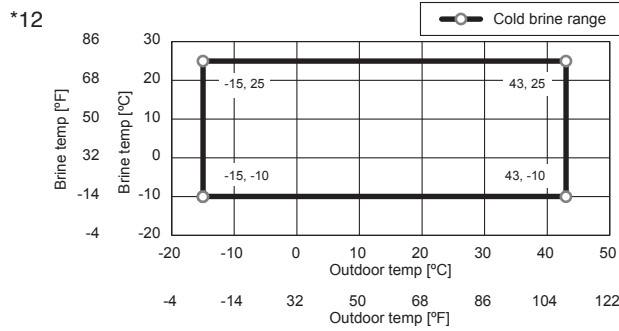

REVERSIBLE HEAT
PUMP

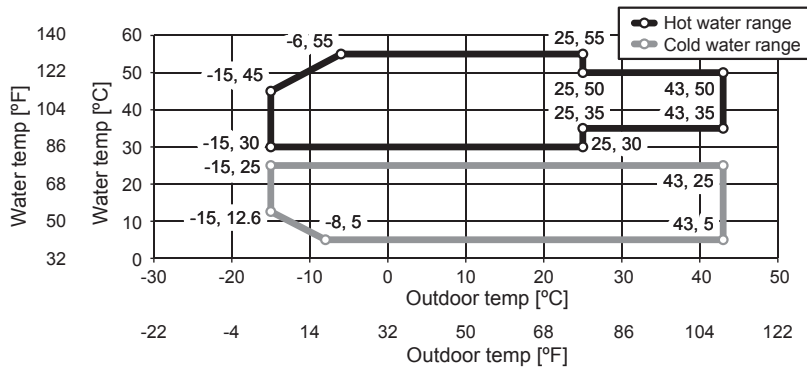

HEATING ONLY

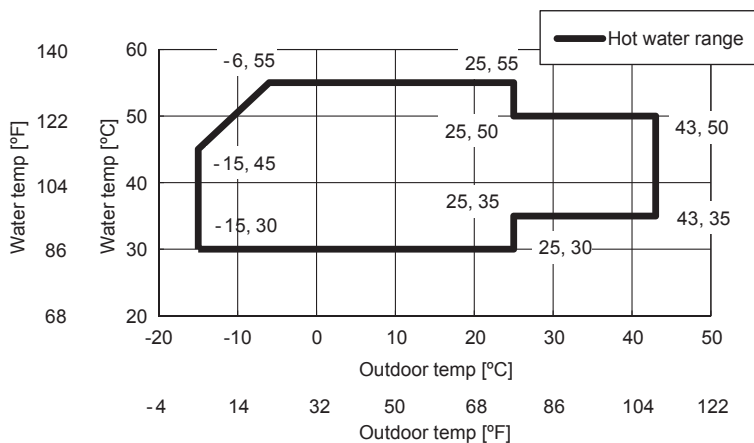

Unit converter

kcal/h = kW x 860
 BTU/h = kW x 3,412
 lbs = kg/0.4536
 cfm = m³/min x 35.31





M1500/M1800

R32 | ME-series

KEY COMPONENTS
SAVE ENERGY

HIGH FUNCTIONALITY
OF MODULAR CHILLERS

BEST IN CLASS
EFFICIENCY FOR
ENERGY SAVING
PERFORMANCE

WIDE OPERATING RANGE
BOTH IN COOLING AND
HEATING MODE

OPTIMUM FREQUENCY
CONTROL

LOW GWP REFRIGERANT R32
FOR REDUCED IMPACT ON
THE ENVIRONMENT

IMPROVED
REDUNDANCY &
RESILIENCE

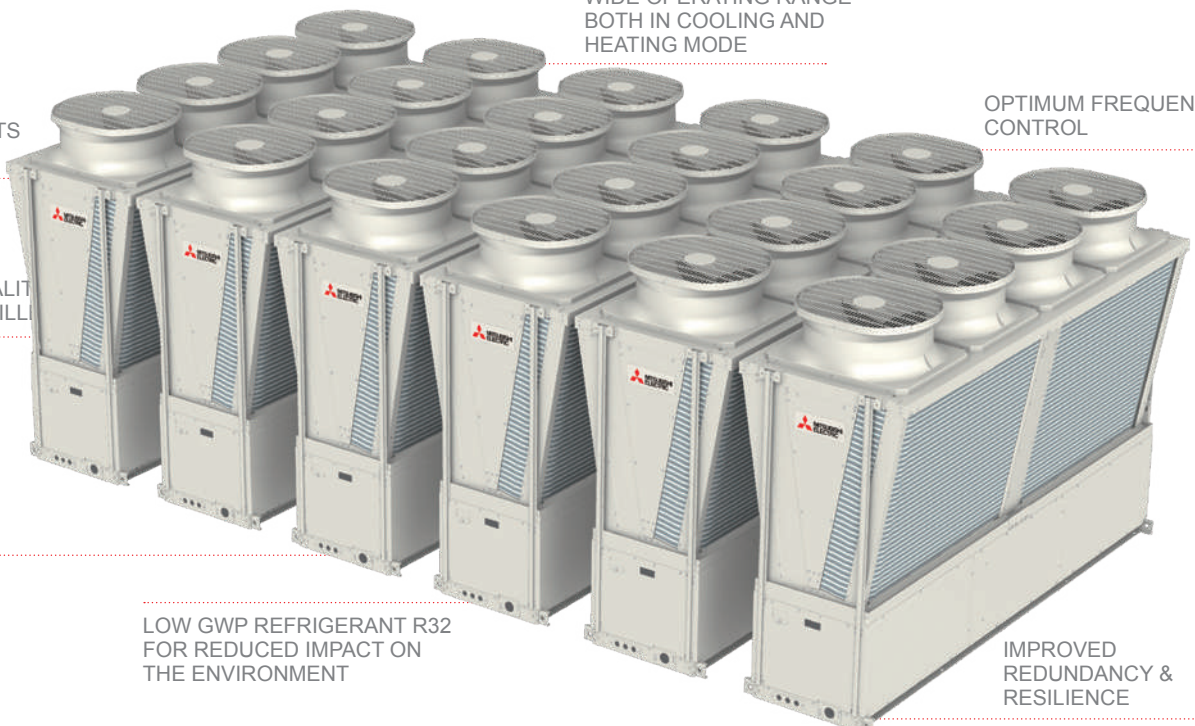

High energy-saving performance thanks to high-performance inverter compressor and proprietary Y-shaped construction.

Best in class efficiency for energy saving performance

The rated and seasonal energy efficiency ratios have been increased to achieve high energy saving performance.

Rated efficiency

The use of the high-efficiency inverter compressors achieves high energy saving performance. The 50 HP model has cooling EER and heating COP rating corresponding to energy saving class A.

Model M1500
EER 3.28*¹

Model M1500
COP 3.47*²

*¹Under normal cooling conditions at outdoor temp 35°DB/24°WB(95°FDB/75.2°FWB) outlet water temp 7°C(44.6°F) inlet water temp 12°C(53.6°F). Pump input is included in cooling capacity and power input based on EN14511.

*²Under normal heating conditions at outdoor temp 7°DB/6°WB(44.6°FDB/42.8°FWB) outlet water temp 45°C(113°F) inlet water temp 40°C(104°F). Pump input is included in heating capacity and power input based on EN14511.

Seasonal efficiency

The use of the high-efficiency inverter compressors ensures optimum operation according to the operation load. The compressors can operate efficiently even during nighttime and intermediate seasons with low load, thereby saving energy throughout the year.

Model M1500
SEER 5.52*¹
SCOP 3.31*¹

SEERavg. +18%
vs R410 version

Model M1800
SEER 5.36*¹
SCOP 3.31*¹

*¹Compliant with EN14511

Key Components and Technologies

The high-grade functionality, energy efficiency, and endurance of the e-series are achieved by Mitsubishi Electric's technology.

Compressor

R32-compatible high-efficiency inverter compressor

Each unit has four high-efficiency R32-compatible inverter compressors. Compared to R410A, R32 has low pressure loss, contributing to better operation efficiency. The inverter compressor automatically controls the compressor frequencies based on various air-conditioning conditions such as outside air temperature and changes in load, helping to achieve higher seasonal efficiency.



Stable operation with a suction chamber injection mechanism

Returning the liquid refrigerant to the suction chamber suppresses a rise in the discharge temperature of R32 while the units are operated at low outside temperatures. The amount of injected refrigerant is adjusted according to the refrigerant state, allowing the units to operate in heating mode at an intake temperature as low as -20°C.

IH (induction heating) warmer

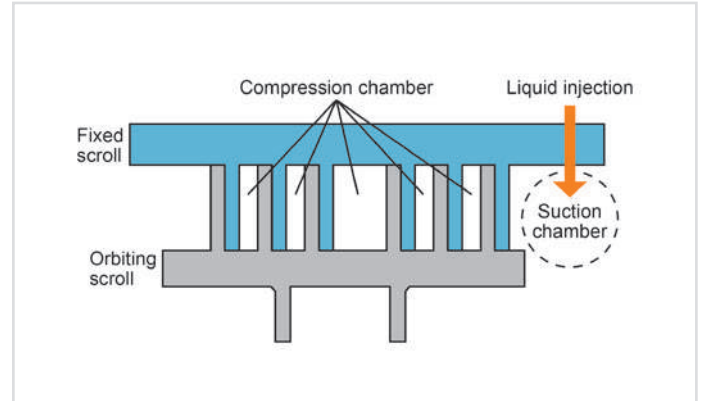

The e-series adopts an IH (induction heating) warmer to prevent refrigerant stagnation while the unit is stopped. The IH warmer suppresses standby power more than the belt case heater, which is wrapped around the compressor shell surface to constantly heat the compressor.

CASE HEATER

Heated from the outside
with a heater

IH WARMER

The magnetic property of the iron motor core inside the compressor is used to heat the compressor shell and prevent refrigerant stagnation while the unit is stopped. In addition, compressor heating remains on for 30 minutes after operation is stopped, and subsequently is switched on and off every 30 minutes. Standby power consumption therefore is lower than a case heater.

Heated by energizing the motor

*Low voltage at a level that will not start up the compressor

Motor
Refrigerant oil in liquid refrigerant

Operation while the air conditioner is stopped

On/off is repeated every 30 minutes

*Normally the compressor is heated while the unit is stopped to prevent liquid refrigerant from remaining in the compressor and to evaporate the liquid refrigerant in the compressor.

Water heat exchanger

Reduction in head loss

Head loss in the water pipe is reduced by the use of a different water heat exchanger and by reducing the number of water piping routes in the unit.

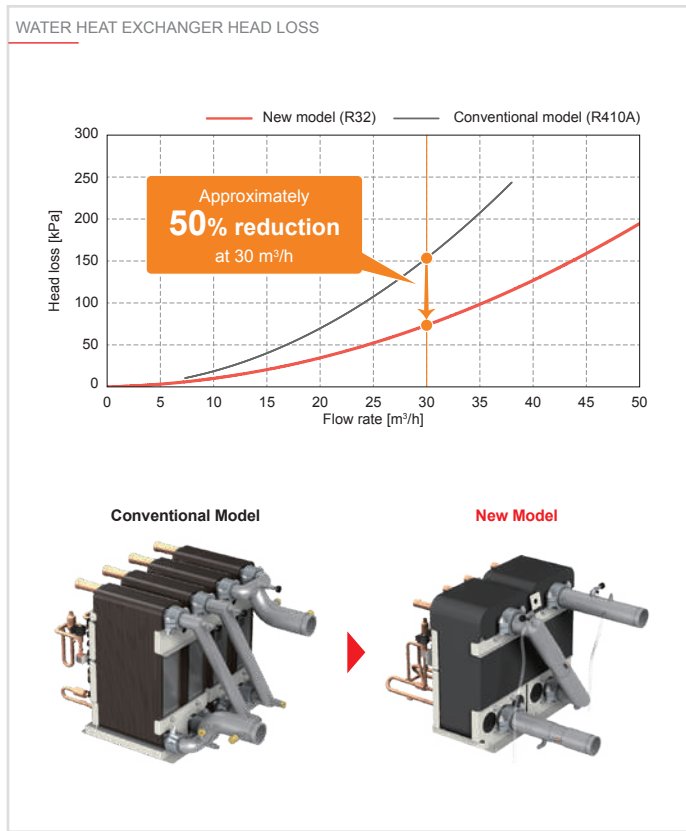

Water piping in the unit

- A water-release plug prevents water splashing when bleeding air.
- Separate air-vent valves are installed at both the inlet and outlet of the water pipes, allowing for easy water drainage just by plugging in and out the plugs.

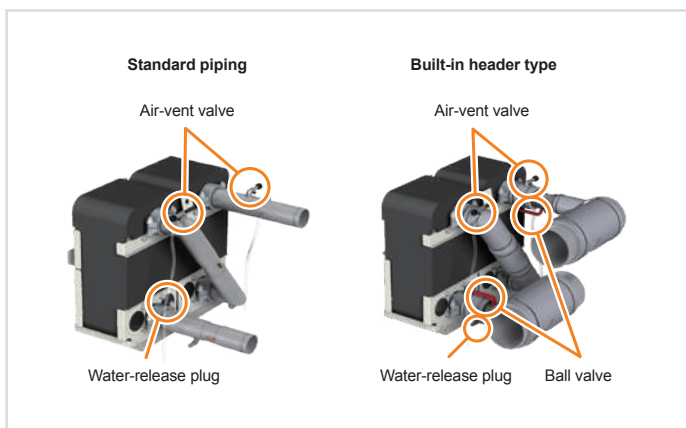

Flat tube heat exchanger

Flat tubes are sub-divided into smaller fins to increase the contact area with the refrigerant, resulting in greater heat-exchanging efficiency. The cooling only models and the heat pump models have fins that are shaped differently to increase the overall heat-exchange efficiency of each model, resulting in reduced refrigerant volume, greater operating range, and higher operation efficiency.

Conventional Model (R410A)

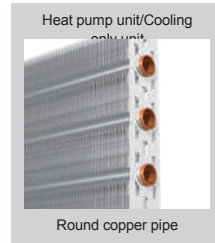

New Model (R32)

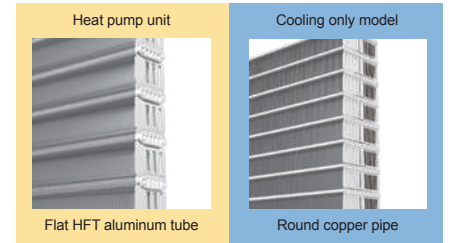

Parallel flow condenser

The heat pump and cooling only models adopt different fins in consideration of the influence of drain water clogging during heating. The heat pump model uses a horizontal flat tube and the cooling only model uses a parallel flow condenser.

The shape of the corrugated fin used in the cooling only model increases the contact area with air and the amount of heat exchange in cooling operation.

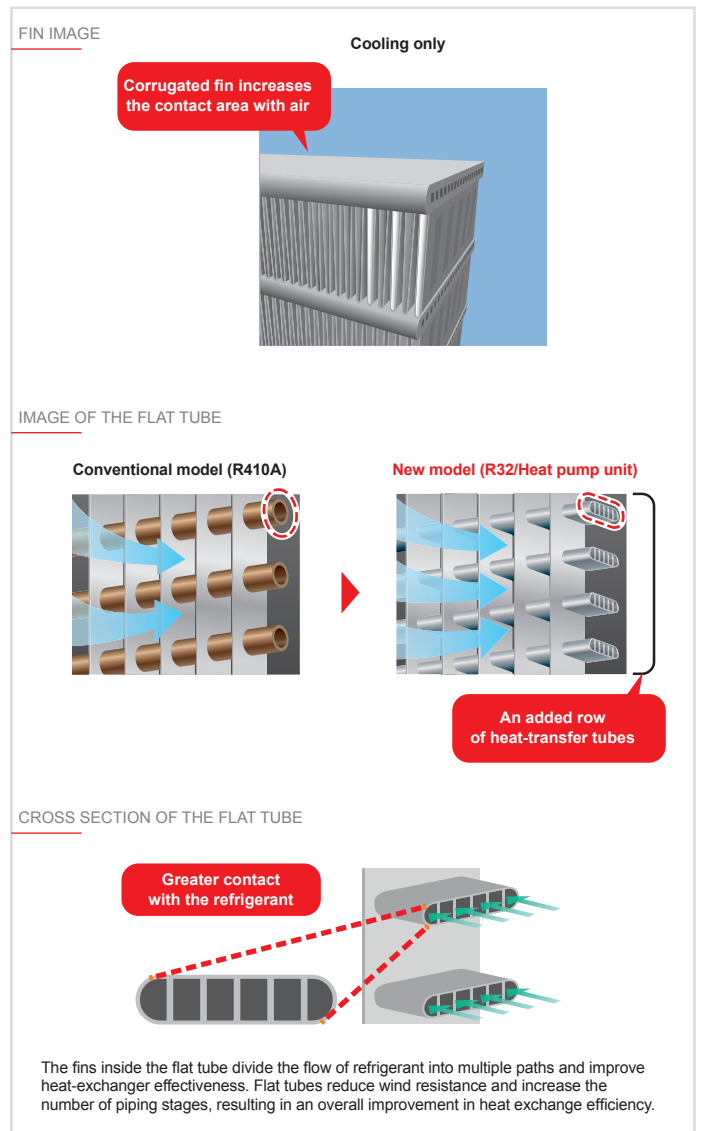

Use of Y-shape structure for effective operation

When the modules are connected, the intake air passages can be ensured on the floor and sides. This structure contributes to effective operation.

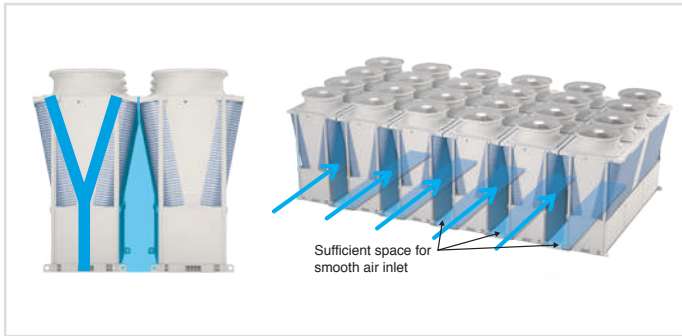

High functionality of modular chiller

The capacity among 1 group can be increased to up to 360 HP by combining units.

Large-capacity 50 HP and 60 HP units are available. Even a 360 HP system using six 60 HP units can be installed in a floor area of 8.53 m × 5.2 m including the service space

* Only modules with the same capacity can be combined.



Heat Pump	EAHV-M1500YCL(-N)
Cooling Only	EACV-M1500YCL(-N)

Heat Pump	EAHV-M1800YCL(-N)
Cooling Only	EACV-M1800YCL(-N)

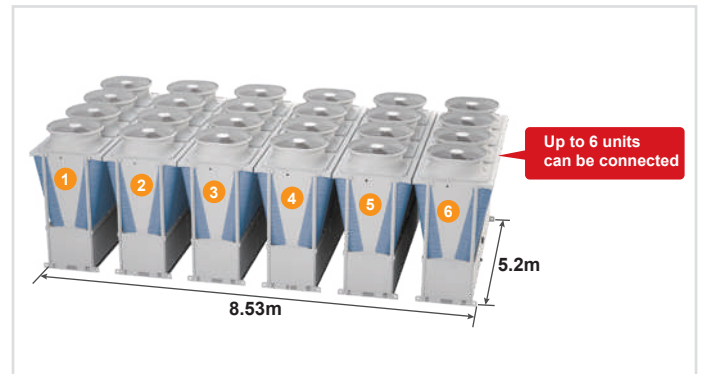

Optimum frequency control

When multiple modules are connected, the frequency of each inverter compressor is controlled during operation to increase the efficiency of each module, achieving a high energy saving performance.

This control can be implemented by simply using our unique M-NET control, without the need for any other on-site design.

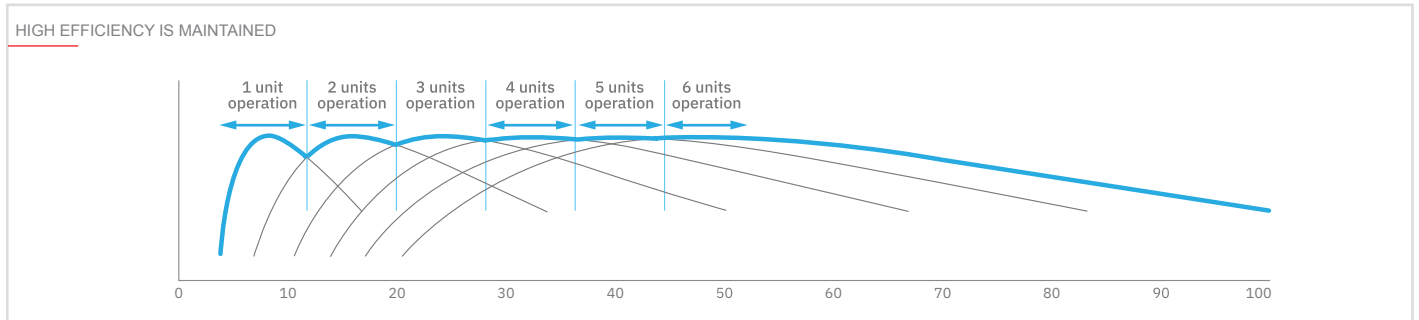

WHEN THE OVERALL SYSTEM LOAD IS 60%

Without optimum frequency control

100% 100% 100% 0% 0%

With non-inverter compressors, it is only possible to turn the unit on or off, and the compressor frequency cannot be adjusted according to the required capacity.

With optimum frequency control

60% 60% 60% 60% 60% 60%

Our modules are equipped with inverter compressors, so the system can be operated in frequency ranges in which the efficiency of each module is at its peak. Optimum frequency control of each unit increases the efficiency of the whole system.

WHEN THE OVERALL SYSTEM LOAD IS 20%

Without optimum frequency control

100% 0% 0% 0% 0%

Since the compressors are running at inefficient frequencies, the efficiency of the whole system is lower.

With optimum frequency control

50% 50% 0% 0% 0% 0%

Peak efficiency is between 40 and 60%. In low load conditions, modules can be switched off to **keep remaining modules at optimum efficiency.** The output of the pumps connected to the remaining group can be decreased, and the efficiency of the whole system is then increased. This control is achieved by connecting to M-NET. There is no need to prepare sensors, and the instrumentation is simple.

Improved redundancy & resilience

When a non-modular chiller is used as the main 300kW unit, as in this example, the same capacity would also be required as a backup. However, when a Mitsubishi Electric e-series modular chiller is used, two modules can still operate even if one module goes down, continuing normal operation. This reduces the backup capacity requirement.

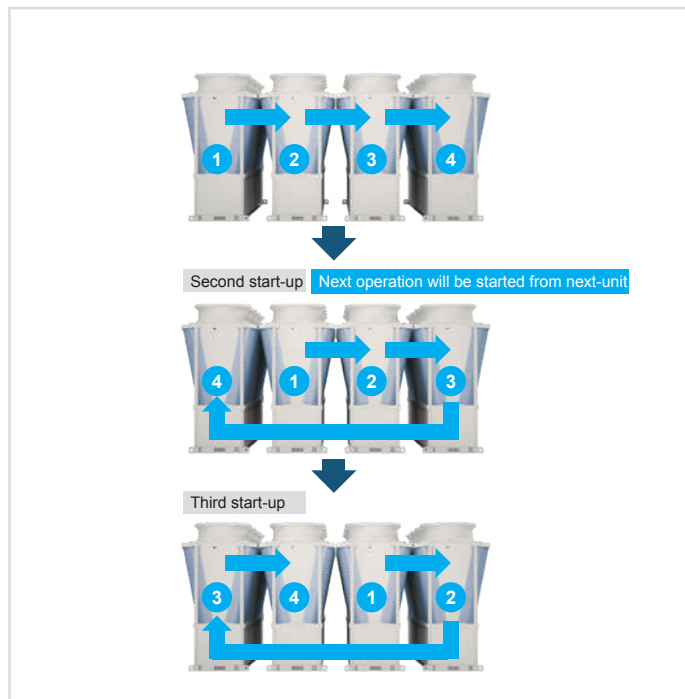
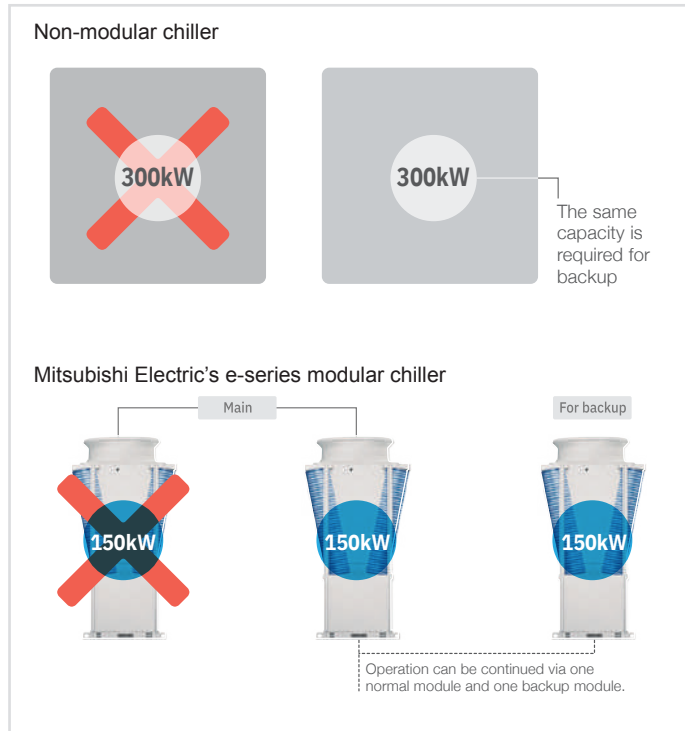

Emergency operation mode

When a single module

The e-series module contains four compressors (two for the 90kW module) developed by Mitsubishi Electric. The four compressors operate as two pairs. If something is wrong with one of the two pairs, the other pair can temporarily continue to operate. The 90kW module achieves this by operating its two compressors independently.



When multiple modules

If one of the e-series modules goes down, the remaining modules can continue to operate. Each module can independently control the outlet water temperature. Even if the main module goes down, operation can be continued.

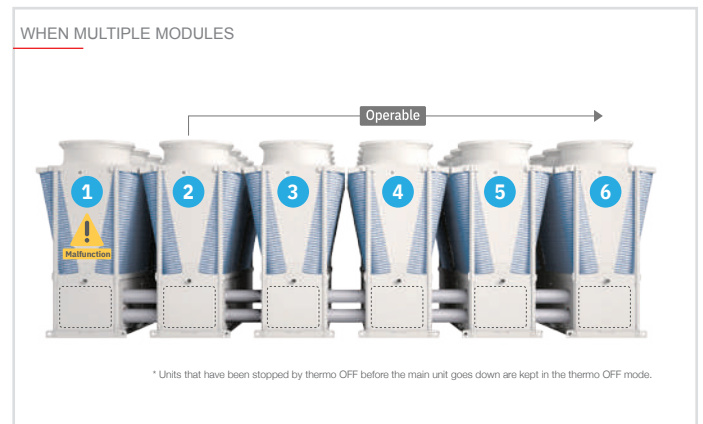

Procedure for installing the connection kit

Selectable piping system

Standard piping and built-in header types are available. The optimum type can be selected according to the design and construction needs of the building.

STANDARD PIPING TYPE	BUILT-IN HEADER TYPE (models with "-N" in the name only)
Type without built-in pump or header	Type of built-in header piping for connection between modules
Advantages The flexibility of design is high, and it is possible to select the most suitable number of pumps and water circuit for the on-site system.	Advantages The piping space and number of connections are reduced, allowing simple construction and short construction times. * It is not possible to build both the pump and the header in each unit.

Standard piping type

The flexibility of design is high, and the system can be designed according to the on-site system and load pattern. Up to 24 units (4 groups × 6 units) can be connected to one system. The number of pumps and the piping structure can be designed according to the on-site.

STANDARD PIPING TYPE
<div style="display: flex; justify-content: space-around;"> <div style="text-align: center;"> <p><System with 6 chillers and one pump></p> </div> <div style="text-align: center;"> <p><System with 6 chillers and 2 pumps></p> </div> </div>

Built-in header type

The piping to connect to other units is built into each unit. The number of piping connections is reduced (saving construction work and reducing the construction time), and the installation space can be also reduced.

BUILT-IN HEADER TYPE
<div style="display: flex; justify-content: space-around;"> <div style="text-align: center;"> <p><Standard piping construction></p> <p>* Less space and equipment cost</p> </div> <div style="text-align: center;"> <p><Built-in header type></p> <p>Piping space is reduced</p> </div> </div>
<p>SPACE FOR RETURN PIPING IS NOT REQUIRED</p> <div style="display: flex; justify-content: space-around;"> <div style="text-align: center;"> <p><Standard piping construction></p> <p>* Reduced installation work</p> </div> <div style="text-align: center;"> <p><Built-in header type> (models with "-N" in the name only)</p> <p>The piping space can be reduced.</p> </div> </div>

Details of built-in header type modules

Up to six units with built-in headers can be connected. (Piping size: 150A)
 When 6 units or a less are connected, flow adjustment and reverse return piping for each unit are unnecessary.

Built-in header type

Header pipings, which are normally required for connecting the unit to local water pipes, are built into the unit. Multiple units are easily connectable by using optional parts. This eliminates the need to procure water pipes for connecting the units, and reduces installation work.

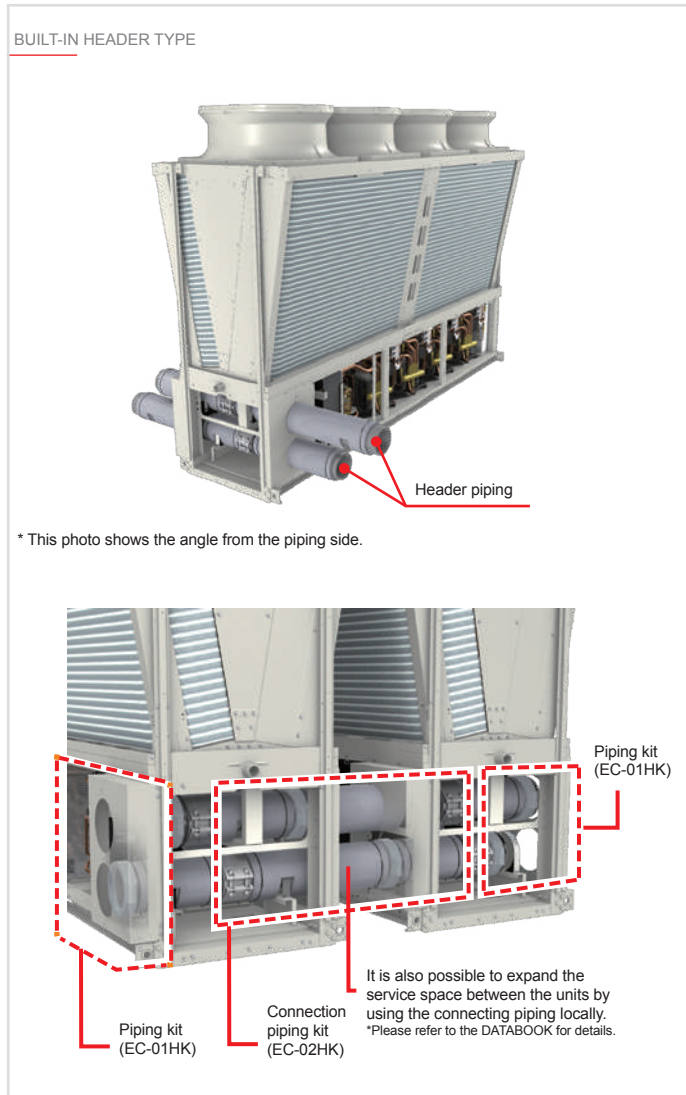

PARTS LIST

EC-01HK
 Optional parts
 (Piping kit)

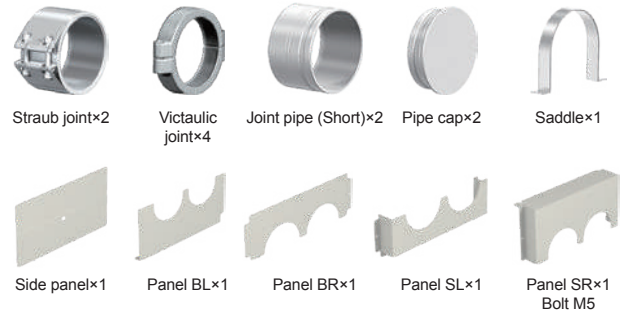

INSTALLING THE PIPING KIT (EC-01HK)

Header piping

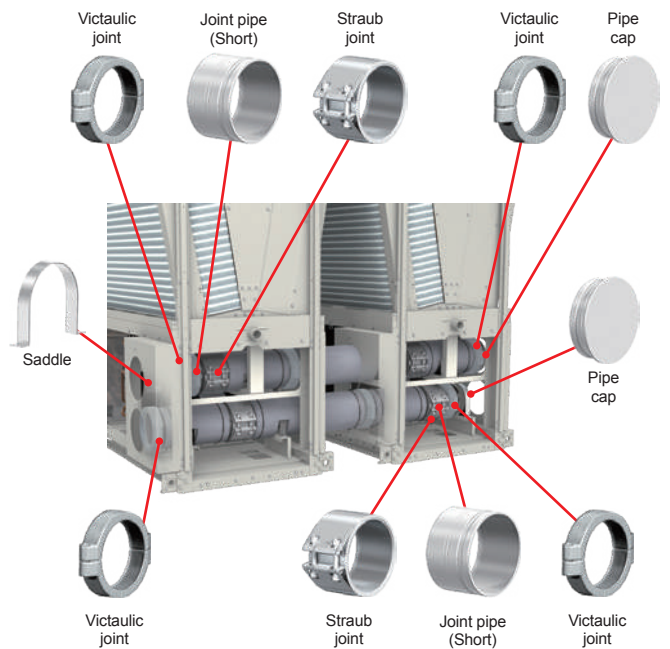

INSTALLING THE PIPING KIT (EC-01HK)

Panel

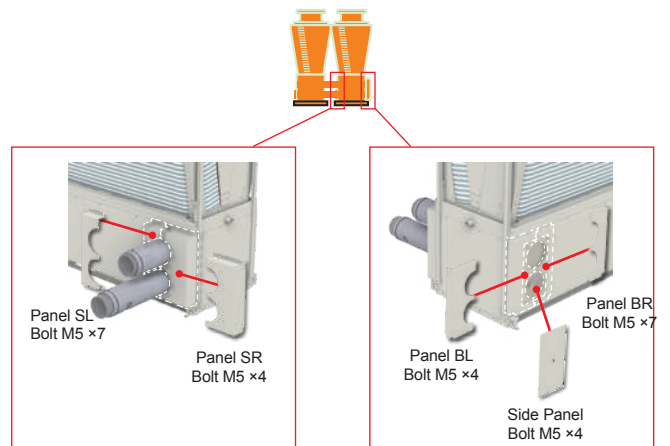

PARTS LIST

EC-02HK
(Connection piping kit)

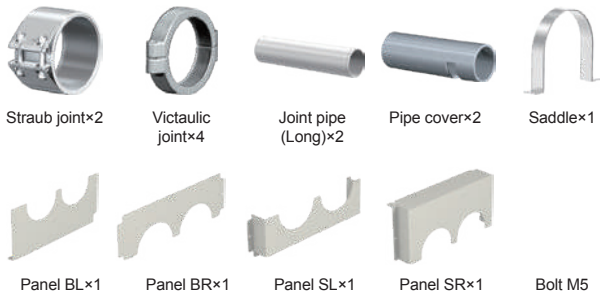

INSTALLING THE PIPING KIT (EC-02HK)

Header piping

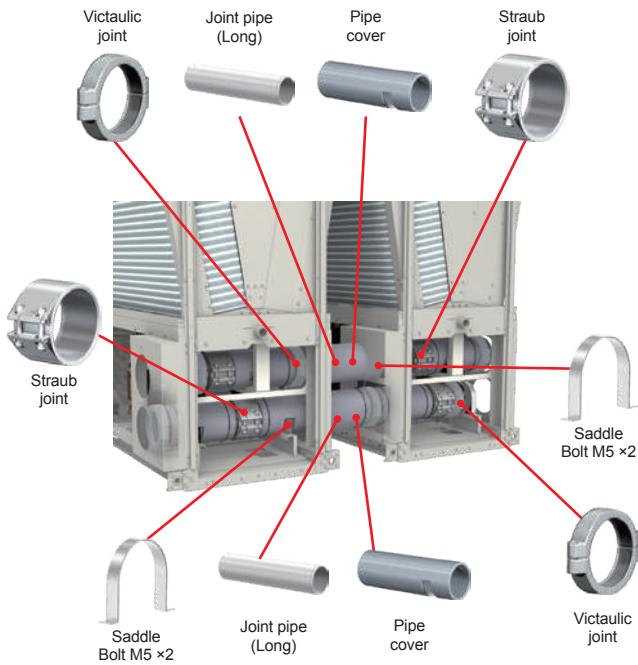

INSTALLING THE PIPING KIT (EC-02HK)

Panel

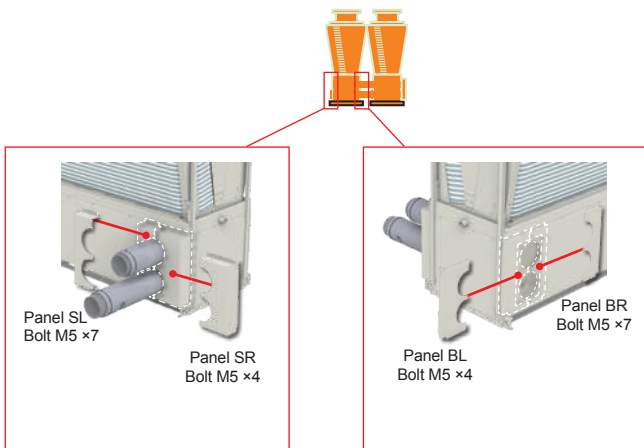

Easy control

The water temperature in each module can be controlled by using local remote controller PAR-W31MAA or by using centralized controller AE-200E. The control method can be selected at the request of each customer.



External signal input

Basic operations, such as operation command, mode switching and water temperature setting, can be performed by inputting external signals directly to the unit.

*Optional products, such as remote controllers, are not always required.



Input	ON/OFF
	Cooling/Heating
	Snow/regular
	Demand
	Target water temperature
Output	Operation command
	Operation mode
	vError
Control function (function of chiller)	Control of number of units Control to prevent simultaneous defrosting

Remote controller

Basic operations, such as ON/OFF, mode switching, water temperature setting and schedule setting, can be performed by connecting a remote controller.

Operation/setting	ON/OFF
	Cooling/Heating/HeatingECO/Anti-freeze
	Snow/Normal
	Demand
	Scheduled operation (daily/weekly)
	Target temperature
Display	Operation mode
	Current water temperature
	Target temperature
	Error code
Control function (function of chiller body)	Control of number of units
	Control to prevent simultaneous defrosting



SYSTEM CONFIGURATION

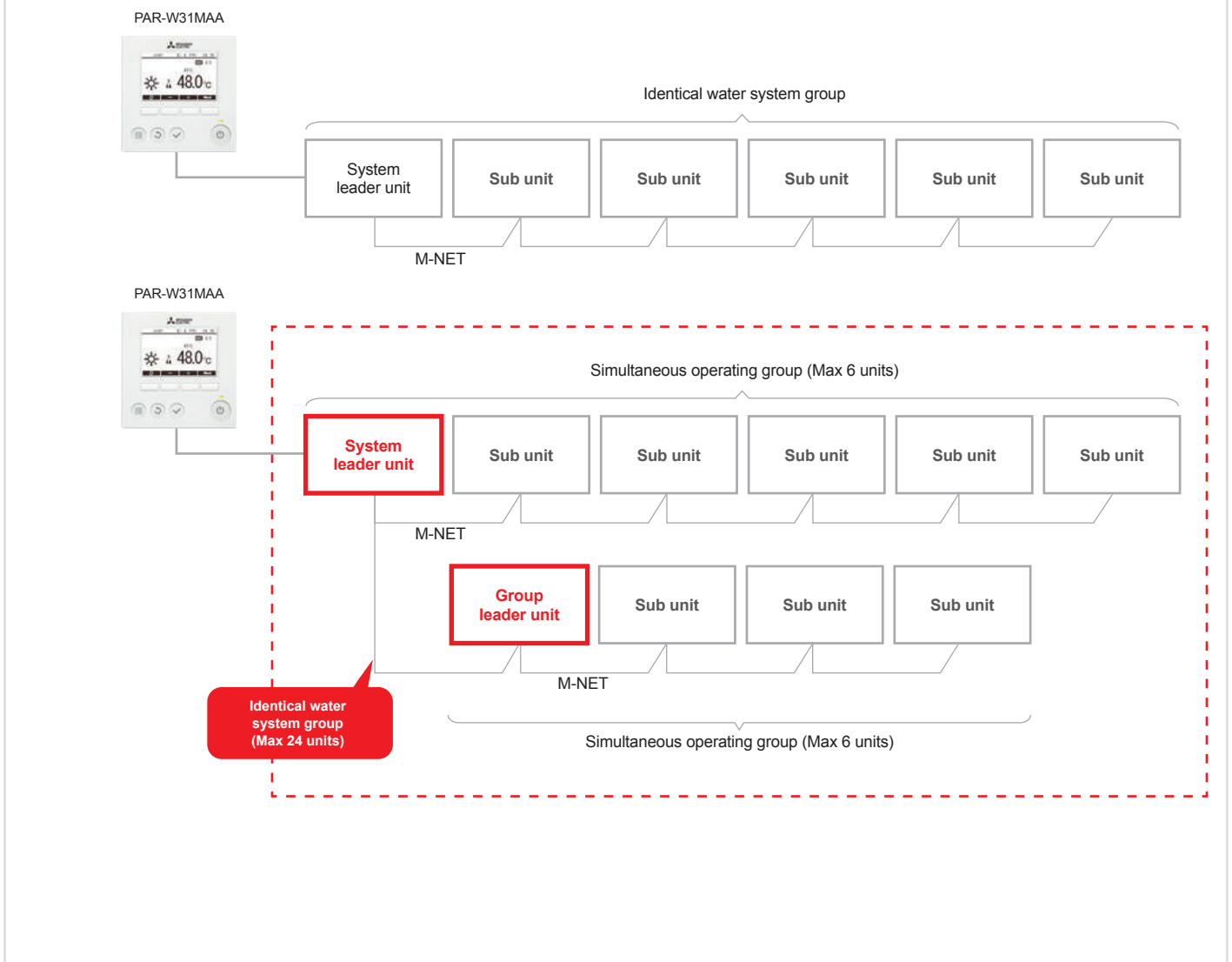

Centralized controller*

The e-series units are connectable to the AE-200E that centrally controls up to 24 units or 24 systems connected via M-NET.

By using EW-50E or AE-50E, the maximum number of connectable units can be further increased.

The use of AE-200E enables various operation settings and integrated control of the e-series and CITY MULTI.

*AE-200E with software Ver.7.8.0 or later can be connected.

Operation/setting	ON/OFF
	Cooling/Heating/HeatingECO/Anti-freeze
	Snow/Normal
	Scheduled operation (daily/weekly/annual)
	Target temperature
	Local control disabled (ON/OFF, operation mode, target temperature)
Display	WEB browser connected
	Operation mode
	Current water temperature
	Error code
	Outdoor temperature
Control function (function of chiller body)	Control of number of units
	Control to prevent simultaneous defrosting



Centralized controller AE-200E

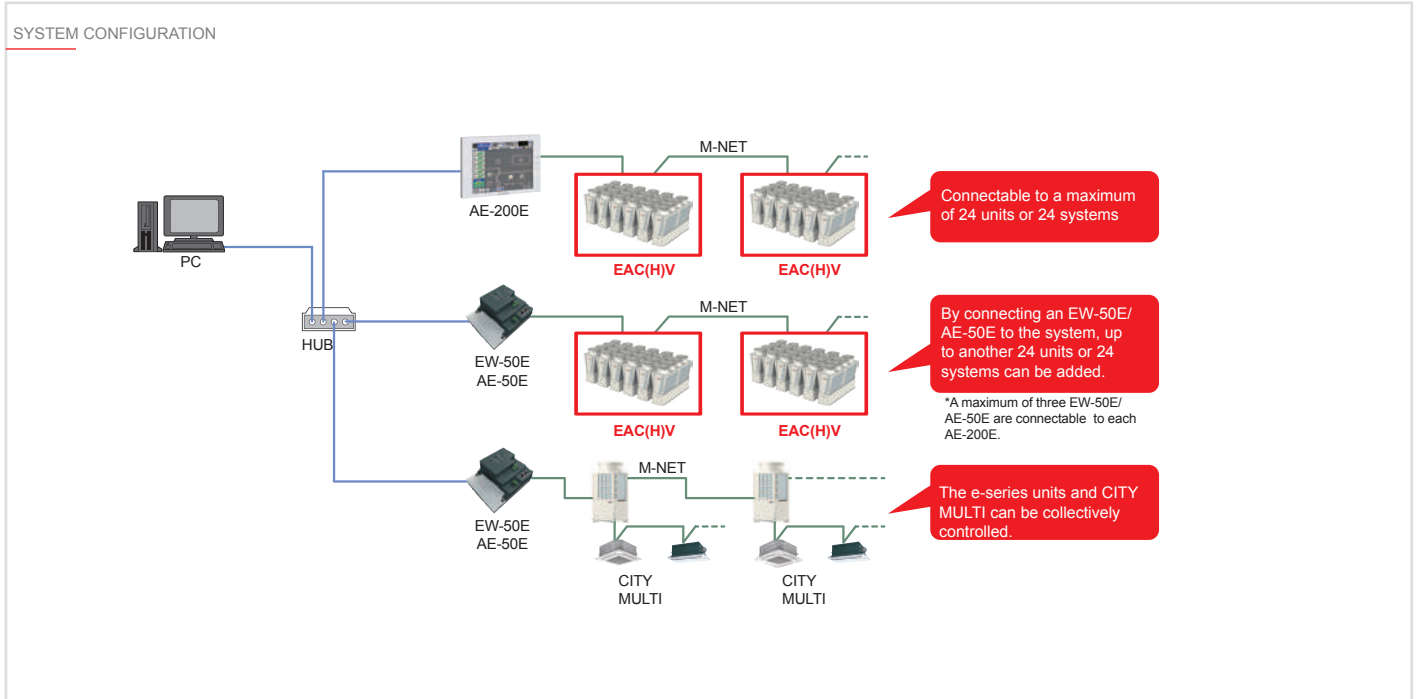

BACnet® connection function

Connectable to a central monitoring device via AE-200E using BACnet®

*BACnet® is a registered trademark of ASHRAE in the United States of America.

*BACnet® can be connected to AE-200E with software Ver.7.9.0 or later.

Operation/setting	ON/OFF
	Cooling/Heating/Heating ECO/Anti-freeze
	Snow/Normal
	Target water temperature
	Local control disabled (ON/OFF, operation mode, target temperature)
Display	ON/OFF
	Cooling/Heating/Heating ECO/Anti-freeze
	Snow/Normal
	Local control disabled (ON/OFF, operation mode, target temperature)
	Inlet/outlet water temperature
	Collective error
	Communication error
Individual unit error	

Technical specifications COOLING ONLY MODEL

MODEL	SET	EACV-M1500YCL(-N)(-BS)	EACV-M1800YCL(-N)(-BS)		
Power source		3-phase 4-wire 380-400-415V 50/60Hz			
Cooling capacity *1		kW	150.00	180.00	
		kcal/h	129,000	154,800	
		BTU/h	511,800	614,160	
	Power input	kW	44.73	57.02	
	EER		3.35	3.16	
	IPLV **		6.42	6.31	
Cooling capacity(EN14511) *2	Water flow rate	m ³ /h	25.8	31.0	
		kW	149.18	178.80	
		kcal/h	128,295	153,768	
		BTU/h	509,002	610,066	
	Power input	kW	45.55	58.22	
	EER (EUROVENT certified)		3.28	3.07	
Current input	SEER		5.52	5.36	
	Water flow rate	m ³ /h	25.8	31.0	
	Cooling current 380-400-415V *1	A	76 - 72 - 69	96 - 91 - 88	
	Maximum current	A		120	
	Water pressure drop *1	Standard piping	kPa	56	79
		Inside header piping	kPa	134	190
Temp range	Cooling	°C	Outlet water 5~30 *5		
		°F	Outlet water 41~86 *5		
	Outdoor	°C	-15~52 *5		
		°F	5~125.6 *5		
Circulating water volume range		m ³ /h	12.9~34.0		
Sound pressure level (measured in anechoic room) at 1m *1		dB (A)	65	67	
Sound power level (measured in anechoic room) *1		dB (A)	83	85	
Diameter of water pipe (Standard piping)	Inlet	mm (in)	65A (2 1/2B) housing type joint		
	Outlet	mm (in)	65A (2 1/2B) housing type joint		
Diameter of water pipe (Inside header piping)	Inlet	mm (in)	150A (6B) housing type joint		
	Outlet	mm (in)	150A (6B) housing type joint		
External finish			Polyester powder coating steel plate		
External dimension HxWxD		mm	2350 x 3400 x 1080		
Net weight	Standard piping	kg (lbs)	1039 (2291)		
	Inside header piping	kg (lbs)	1067 (2352)		
Design pressure	Refrigerant	MPa	4.15		
	Water	MPa	1.0		
Heat exchanger	Water side		Stainless steel plate and copper brazing		
	Air side		Salt-resistant corrugated fin & aluminium micro channel		
Compressor	Type		Inverter scroll hermetic compressor		
	Maker		MITSUBISHI ELECTRIC CORPORATION		
	Starting method		Inverter		
	Quantity		4		
	Motor output	kW	11.5 x 4		
	Lubricant		MEL46EH		
Fan	Air flow rate	m ³ /min	270 x 4		
		L/s	4500 x 4		
		cfm	9534 x 4		
	Type, Quantity		Propeller fan x 4		
	Starting method		Inverter		
	Motor output	kW	0.92 x 4		
External static press.	Pa	20			
Protection	High pressure protection		High pres.Sensor & High pres.Switch at 4.15MPa (601psi)		
	Inverter circuit		Over-heat protection, Over current protection		
	Compressor		Over-heat protection		
Refrigerant *3	Type x charge		R32 x 4.7 (kg) x 4 *3		
	Control		LEV		

*1 Under normal cooling conditions at outdoor temp 35°C DB / 24°C WB (95°F DB / 75.2°F WB) outlet water temp 7°C (44.6°F) inlet water temp 12°C (53.6°F). Pump input is not included in cooling capacity and power input.

*2 Under normal cooling conditions at outdoor temp 35°C DB / 24°C WB (95°F DB / 75.2°F WB) outlet water temp 7°C (44.6°F) inlet water temp 12°C (53.6°F). Pump input is included in cooling capacity and power input based on EN14511.

*3 Amount of factory-charged refrigerant is 3 (kg) x 4. Please add the refrigerant at the field.

*4 IPLV is calculated in accordance with AHRI 550-590.

*Please don't use the steel material for the water piping.

*Please always make water circulate, or pull the circulation water out completely when not in use.

*Please do not use groundwater or well water directly.

*The water circuit must be closed circuit.

*Due to continuous improvement, the above specifications may be subject to change without notice.

*This model is not equipped with a pump.

Technical specifications HEATPUMP MODEL

MODEL	SET	EAHV-M1500YCL(-N)(-BS)	EAHV-M1800YCL(-N)(-BS)	
Power source		3-phase 4-wire 380-400-415V 50/60Hz		
Cooling capacity *1		kW	150.00	180.00
		kcal/h	129,000	154,800
		BTU/h	511,800	614,160
	Power input	kW	44.73	57.02
	EER		3.35	3.16
	IPLV *6		6.42	6.31
Cooling capacity(EN14511) *2	Water flow rate	m ³ /h	25.8	31.0
		kW	149.18	178.80
		kcal/h	128,295	153,768
		BTU/h	509,002	610,066
	Power input	kW	45.55	58.22
	EER (EUROVENT certified)		3.28	3.07
Heating capacity *3	SEER		5.52	5.36
	Water flow rate	m ³ /h	25.8	31.0
		kW	150.00	180.00
		kcal/h	129,000	154,800
		BTU/h	511,800	614,160
	Power input	kW	42.61	53.09
Heating capacity(EN14511) *4	COP		3.52	3.39
	Water flow rate	m ³ /h	25.8	31.0
		kW	150.82	181.20
		kcal/h	129,705	155,832
		BTU/h	514,598	618,254
	Power input	kW	43.43	54.29
Current input	COP		3.47	3.34
	SCOP Low temp. application/Medium temp. applic.		3.31 / 2.88	
	Water flow rate	m ³ /h	25.8	31.0
	Cooling current 380-400-415V *1	A	76 - 72 - 69	96 - 91 - 88
	Heating current 380-400-415V *3	A	72 - 68 - 66	90 - 85 - 82
	Maximum current	A	120	
Water pressure drop *1	Standard piping	kPa	56	79
	Inside header piping	kPa	134	190
Temp range	Cooling	°C	Outlet water 4~30 *7	
		°F	Outlet water 39.2~86 *7	
	Heating	°C	Outlet water 25~55 *7	
		°F	Outlet water 77~131 *7	
	Outdoor (Cooling)	°C	-15~-52 *7	
		°F	5~125.6 *7	
Outdoor (Heating)	°C	-20~43 *7		
	°F	-4~109.4 *7		
Circulating water volume range		12.9~43.0		
Sound pressure level (measured in anechoic room) at 1m *1		dB (A)	65	67
Sound power level (measured in anechoic room) *1		dB (A)	83	85
Diameter of water pipe (Standard piping)	Inlet	mm (in)	65A (2 1/2B) housing type joint	
	Outlet	mm (in)	65A (2 1/2B) housing type joint	
Diameter of water pipe (Inside header piping)	Inlet	mm (in)	150A (6B) housing type joint	
	Outlet	mm (in)	150A (6B) housing type joint	
External finish		Polyester powder coating steel plate		
External dimension HxWxD		mm	2350 x 3400 x 1080	
Net weight	Standard piping	kg (lbs)	1280 (2822)	
	Inside header piping	kg (lbs)	1307 (2881)	
Design pressure	Refrigerant	MPa	4.15	
	Water	MPa	1.0	
Heat exchanger	Water side		Stainless steel plate and copper brazing	
	Air side		Salt-resistant cross fin & aluminium tube	
Compressor	Type		Inverter scroll hermetic compressor	
	Maker		MITSUBISHI ELECTRIC CORPORATION	
	Starting method		Inverter	
	Quantity		4	
	Motor output	kW	11.5 x 4	
	Lubricant		MEL46EH	
Fan	Air flow rate	m ³ /min	270 x 4	
		L/s	4500 x 4	
		cfm	9534 x 4	
	Type, Quantity		Propeller fan x 4	
	Starting method		Inverter	
	Motor output	kW	0.92 x 4	
External static press.	Pa	20		
Protection	High pressure protection		High pres.Sensor & High pres.Switch at 4.15MPa (601psi)	
	Inverter circuit		Over-heat protection, Over current protection	
	Compressor		Over-heat protection	
Refrigerant *5	Type x charge		R32 x 11.5 (kg) x 4 *5	
	Control		LEV	

*1 Under normal cooling conditions at outdoor temp 35°C DB / 24°C WB (95°F DB / 75.2°F WB) outlet water temp 7°C (44.6°F) inlet water temp 12°C (53.6°F). Pump input is not included in cooling capacity and power input.

*2 Under normal cooling conditions at outdoor temp 35°C DB / 24°C WB (95°F DB / 75.2°F WB) outlet water temp 7°C (44.6°F) inlet water temp 12°C (53.6°F). Pump input is included in cooling capacity and power input based on EN14511.

*3 Under normal heating conditions at outdoor temp 7°C DB / 6°C WB (44.6°F DB / 42.8°F WB) outlet water temp 45°C (113°F) inlet water temp 40°C (104°F). Pump input is not included in heating capacity and power input.

*4 Under normal heating conditions at outdoor temp 7°C DB / 6°C WB (44.6°F DB / 42.8°F WB) outlet water temp 45°C (113°F) inlet water temp 40°C (104°F). Pump input is included in heating capacity and power input based on EN14511.

*5 Amount of factory-charged refrigerant is 3 (kg) x 4. Please add the refrigerant at the field.

*6 IPLV is calculated in accordance with AHR1 550-590.

*Please don't use the steel material for the water piping.

*Please always make water circulate, or pull the circulation water out completely when not in use.

*Please do not use groundwater or well water directly.

*The water circuit must be closed circuit.

*Due to continuous improvement, the above specifications may be subject to change without notice.

*This model is not equipped with a pump.

Operating limits

COOLING ONLY

Operable in cooling mode at an intake air temperature of up to 52°C.

The use of the flat tube heat exchanger has made it possible to increase the maximum intake air temperature from 43°C to 52°C in cooling mode, extending the cooling performance of the units in intense heat and in collective installation.

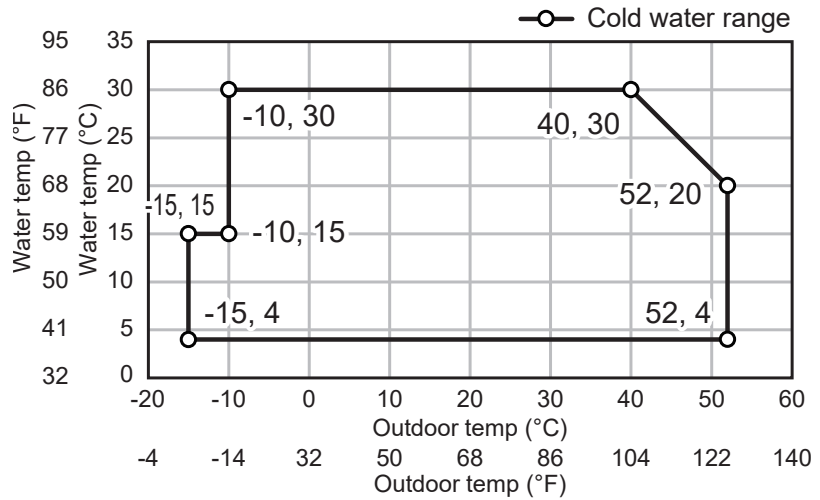

REVERSIBLE HEAT PUMP

Operable in heating mode at an intake air temperature of down to -20°C.

The new model has a greater heating capacity range due to the flat tube heat exchanger and the suction chamber injection mechanism of the compressor. It is operable at the minimum intake air temperature of -20°C and the minimum outlet water temperature of 25°C. The new model is suitable for use in manufacturing lines requiring heating throughout the year.

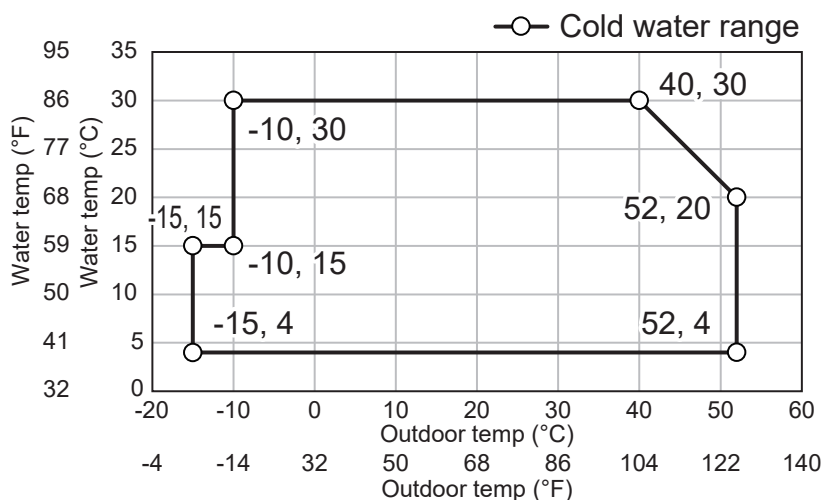
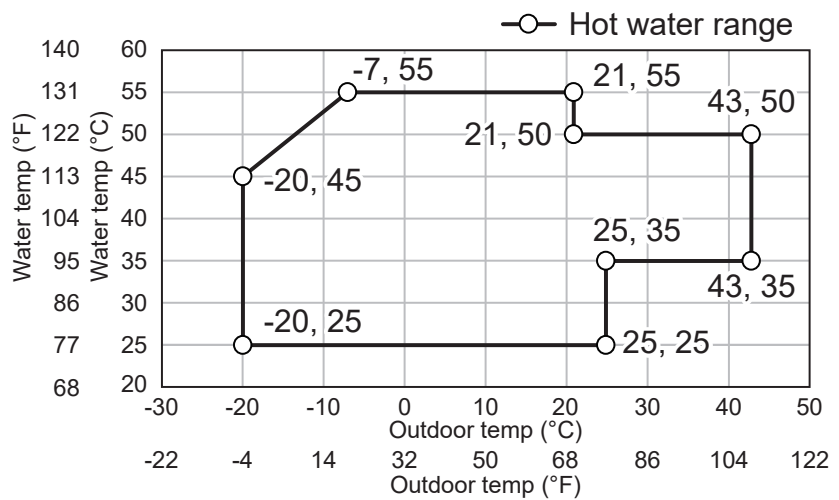

R32 refrigerant properties

Under the conditions shown below, there is a possibility that R32 could burn.

	R32	R410	R22
Chemical formula	CH ₂ F ₂	CH ₂ F ₂ /CHF ₂ CF ₃	CHClF ₂
Composition (blend ratio wt. %)	Single composition	R32/R125 (50/50 wt %)	Single composition
Ozone depletion potential (ODP)	0	0	0.055
Global warming potential (GWP) *1	675	2088	1810
LFL(vol.%) *2	13.3	-	-
UFL(vol.%) *3	29.3	-	-
Flammability *4	Lower flammability (2L)	No flame propagation (1)	No flame propagation (1)

*1 IPCC 4th assessment report

*2 LFL: Lower flammable limit

*3 UFL: Upper flammable limit

*4 ISO 817:2014

*5 R32 consistency is higher than LFL*2 and lower than UFL*3.

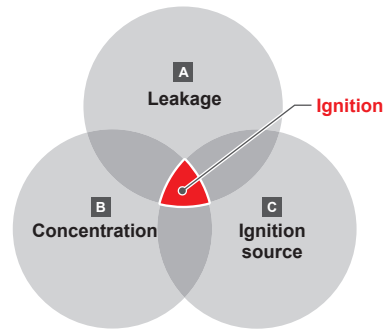

- A Do not leak refrigerant.**
 - <Installation>
 - Vacuum drying should be done.
 - Do not release refrigerant into the atmosphere unnecessarily.
 - Follow "Installation points of charging refrigerant."
 - <Repair/Removal>
 - Refrigerant should be recovered.
- B Prevent concentration.**
 - Follow "Installation restrictions".
- C Keep ignition sources away from the unit.**
 - Do not braze pipes that contain refrigerant. Before brazing, refrigerant should be recovered.
 - Do not install the unit while electricity is on. Turn off electricity and check using a tester.
 - Do not smoke during work and transportation.

Note: Both R32 / R410A emit toxic gas when exposed to naked flame.

	Gauge manifold	Charge hose	Electronic weight scales	Charge valve	Electric leak tester (Gas leak detector)	Vacuum pump	Vacuum pump adapter	Refrigerant recovery equipment	Refrigerant recovery cylinder
TOOLS									
R32	Shareable *3	Shareable *3	Shareable *3	Shareable *3	Shareable *3	Shareable *3	Shareable *3	Shareable *3	EXCLUSIVE
R410	Shareable *3	Shareable *3	Shareable *3	Shareable *3	Shareable *3	Shareable *3	Shareable *3	Shareable *3	EXCLUSIVE

NOTE: Be sure to confirm with the manufacturers that the electric leak tester, vacuum pump and refrigerant recovery equipment are compliant with R32.

*1 Refer to catalogs provided by the manufacturers of the tools above to ensure that the tools are usable with R32.

*2 Do not use R32 and R410A in combination in the same refrigerant recovery cylinder.

*3 The types of tools required for R32 units and R410A units are the same. Each tool must be used only with either R32 units or R410A units.

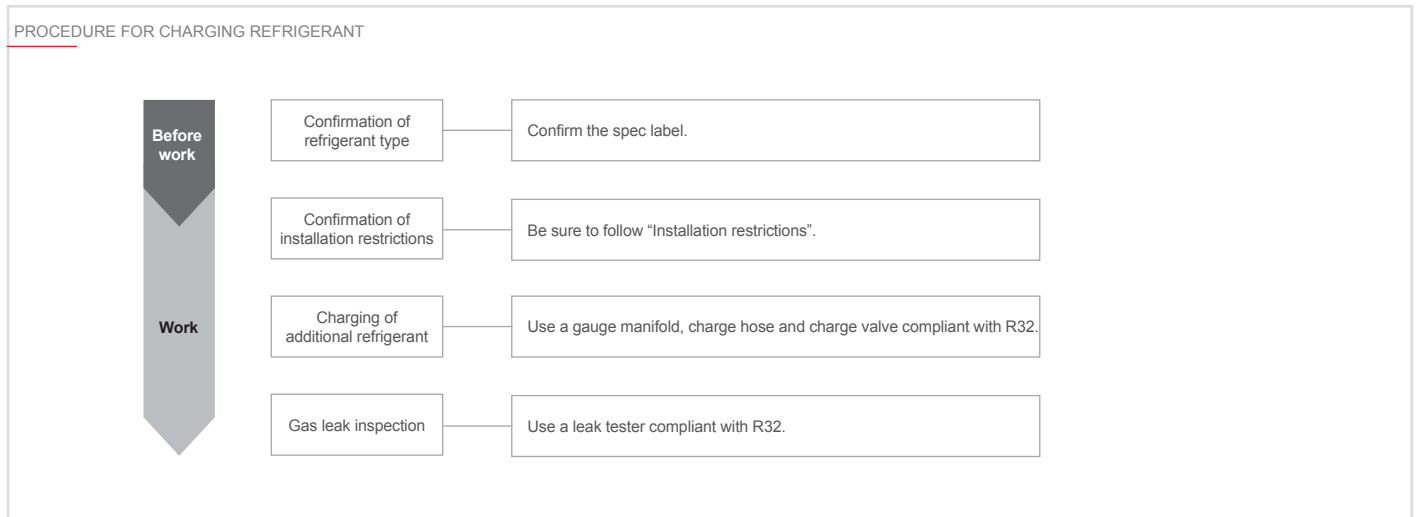

Installation restrictions

Do not install the unit where combustible gas may leak

- If combustible gas accumulates around the unit, fire or explosion may result.

- Provide sufficient space around the unit for effective operation, efficient air movement, and ease of access for maintenance
- All restrictions mentioned in this manual apply not only to new installations but also to relocations and layout changes
- Refer to the Installation manual for other precautions on installation

Installation space requirement

- Do not install the unit inside a building such as the basement or machine room, where the refrigerant may stagnate
- Install the unit in a place where at least one of four sides is open

CORRECT INSTALLATION

If the unit needs to be installed in a space where all four sides are blocked, confirm that one of the following situations (A or B) is satisfied.

A Install the unit in a space with a wall height of ≤ 0.125 m.

Wall height ≤ 0.125 m
(No restrictions apply to the refrigerant amount)

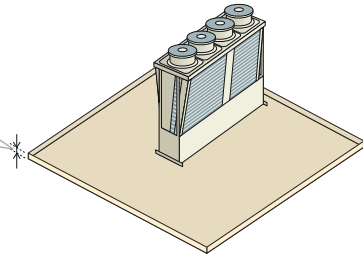

Wall height ≤ 0.125 m

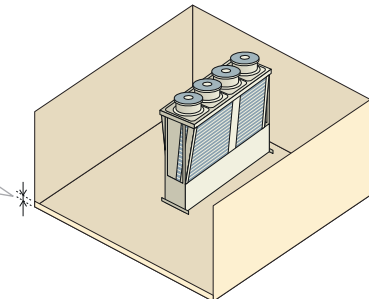

B Create an appropriate ventilation opening.

Wall opening > 0.5 m

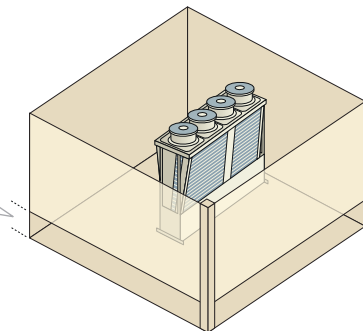

CORRECT INSTALLATION

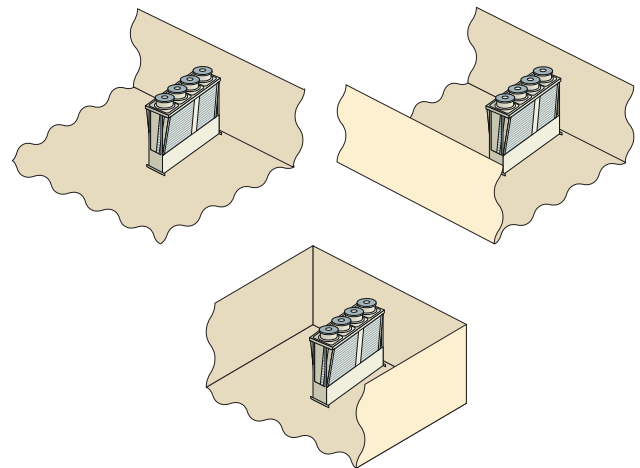

INCORRECT INSTALLATION

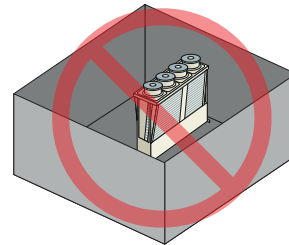

Regulatory requirements for safety

See below for information on installing a safety device on the air cooled chilling unit system

*Safety devices shall be regularly inspected, maintained, and replaced in accordance with relevant laws, regulations, and the instructions of the manufacturers.

*The requirements listed below were established based on IEC60 335-2-40 (Edition 5.0) G.G.6. See the original standards for further information on selecting a safety device.

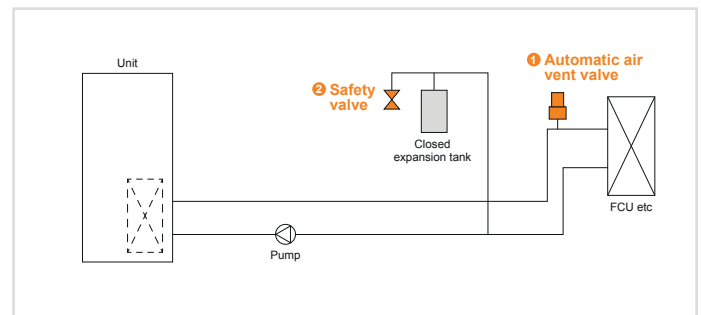

Required items	Note
Automatic air vent valve	* In the event of a failure of the waterside heat exchanger in the unit, the refrigerant may leak from the automatic air vent valve, so install it in a place where the refrigerant will not accumulate, such as outdoors.
Safety valve	* In the event of a failure of the waterside heat exchanger in the unit, the refrigerant may leak from the safety valve, so install it in a place where the refrigerant will not accumulate, such as outdoors.

IT Cooling

s-MEXT split system

s-MEXT split System	368
s-MEXT G00 System	374
s-MEXT G00 Indoor Unit	376
Mr. SLIM Outdoor Unit	378

MULTIDENSITY modular system

MULTIDENSITY	380
m-MOCU	384
m-MROW / m-MRAC	386





s-MEXT split system

Close Control Unit for IT Cooling applications.
Direct expansion system, full inverter for Edge Data Center.



Edge computing: the new trend for cloud decentralization

A new concept that places it self side by side to cloud computing is appearing on the market, thanks to the unstoppable digital transformation we are experiencing. It's the Edge computing.

In 2018, into the top ten strategic technological trends for companies and organizations, Gartner, a leading company in research and consulting, reported the "Cloud to the Edge" trend in fifth position.

This technology imposes the cloud decentralization, which translate into a new reference model for designing data centers. Concepts like IoT, 5G will inevitably lead a resources fragmentation in data centers

management. In fact, we speak of granularity, investments in smaller and widespread data centers, developed to respond to the growing demand for web connections with low latency and high performances.

As result, data processing times will have to be faster, and the only way to comply with both the connections' growing number and consumers' needs in terms of performances will have to be, according to the experts, to data processing closer to the users themselves.

Then we start to talk about Edge Data Centers, little data centers or server rooms, scattered on territory and used to host cloud services and local data processing.



cloud

users



cloud

edge
datacenter

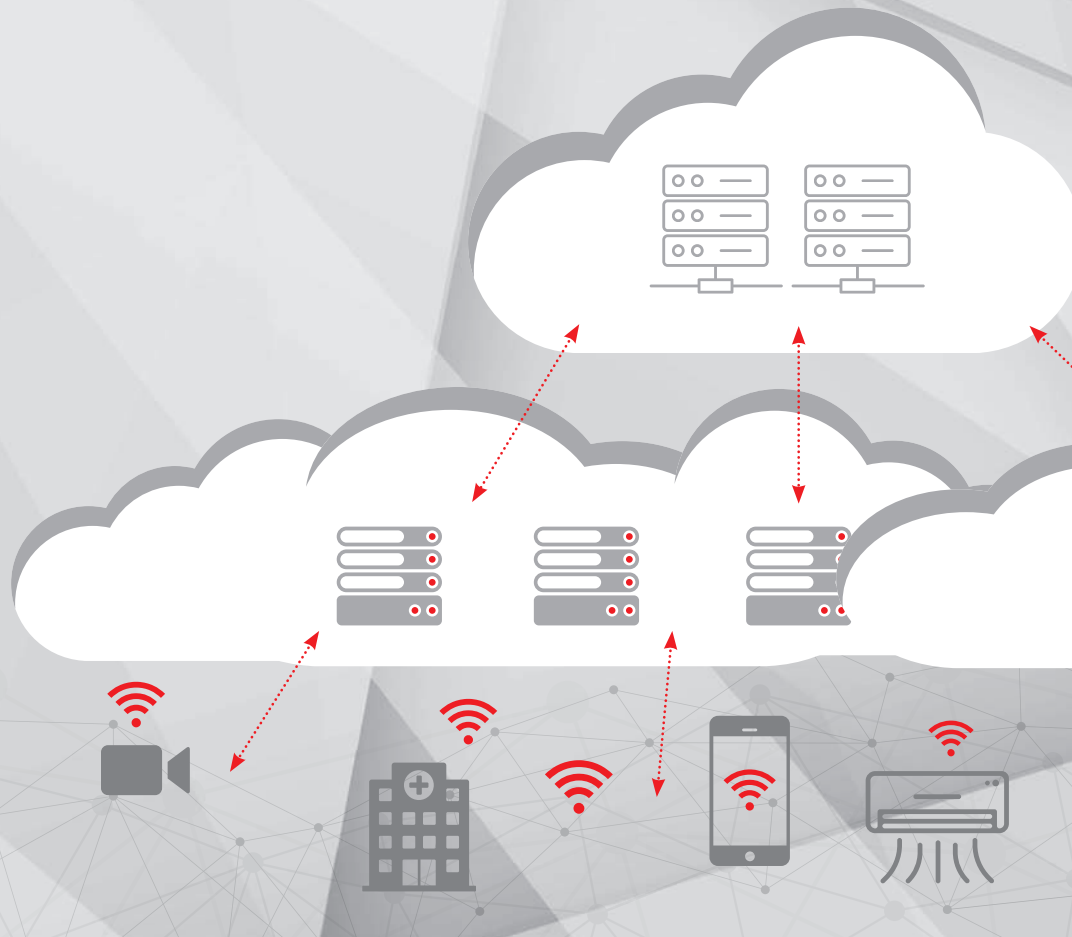



Cloud Computing

Traditional cloud model

The traditional model is facing some latency problems, limited bandwidth, dependability that cause traffic congestions, not suitable for future IoT implementations.

Advantages: large data processing capacity for complex analysis.

Products and applications: chillers, precision conditioners, infrastructures, control systems and accessories with RC brand.



Edge Computing

Distributed intelligence model

Edge computing, by distributing intelligence, will bring down the reduction of the amount of data to be processed, prioritizing management of critical data, latency sensitive, next to the users, filtering and passing to the cloud less impacting data. It will manage big data processing.

Advantages: low latency, high elaboration performances with less investments in infrastructures.

Products and applications: precision air conditioners, infrastructures, control systems and accessories branded Mitsubishi Electric and RC.







s-MEXT G00 system

R32

HIGH EFFICIENCY LEVEL,
REDUCED OCCUPATION



S-MEXT COMBINES MORE THAN
50 YEARS OF EXPERIENCE OF
RC BRAND IN THE IT COOLING
MARKET, WITH THE MITSUBISHI
ELECTRIC EXCELLENCE QUALITY.

S-MEXT AND MR. SLIM
PERFECT SYNERGY



MITSUBISHI ELECTRIC QUALITY
READY TO SERVE YOUR EDGE
DATA CENTER



Mitsubishi Electric present s-MEXT, developed with the RC experience and notoriety in the IT Cooling market: the brand new combined system that combines all the experience of a specialized brand in precision air conditioning with the technological excellence and reliability of Mitsubishi Electric.

The innovative system dedicated to Edge Data Center combines a precision air conditioner (indoor unit) with the commercial outdoor unit of Mr.Slim series.

Best kW/m² Ratio

Thanks to the innovative system, s-MEXT guarantees high level performances while occupying very small floor space. It's compact layout allows to easily integrate the unit in existing data centers, without sacrificing any kW per square meter.

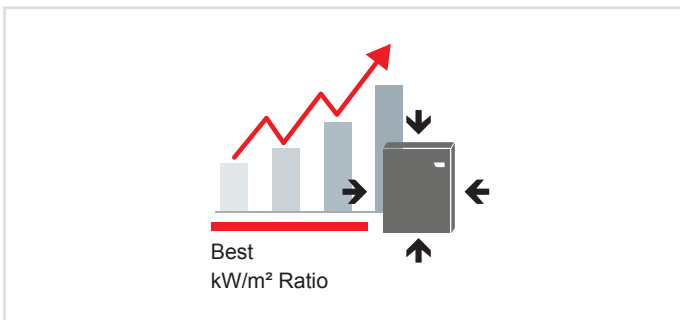

Efficiency beyond expectations

A data center's air conditioning system accounts for over 40% of total data center energy consumption. An efficient approach to air conditioning can generate an enormous advantage in efficiency and reduction of operating costs.

s-MEXT system is characterized by high quality components and control logics aimed at managing the system in the most efficiency mode.

- DC inverter scroll for linear and continuous modulation of cooling capacity based on the load.
- DC fans for best modulation of the air flow.

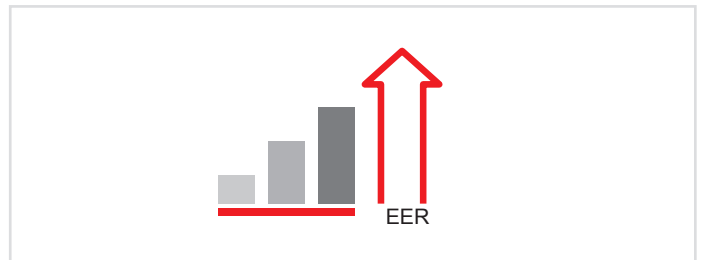

Beyond the traditional Operational limits

The continuous increase of the thermal load in the IT environments has led to an increasing temperature inside the server rooms (up to 27°C) s-MEXT system has been developed to operate with return air temperature up to 35°C.

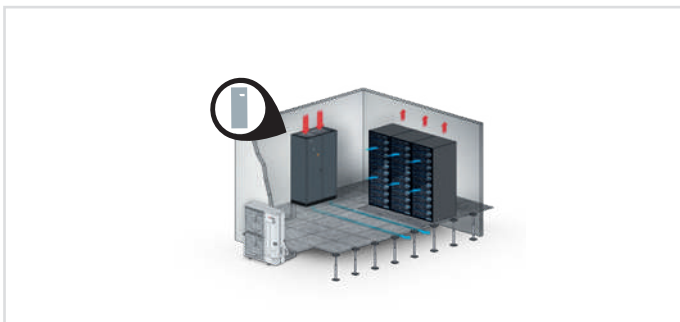

Flexibility in the air flows' choice

Flexible installation of the unit, thanks to the possibility of choosing between two air requirements: Under and Over.

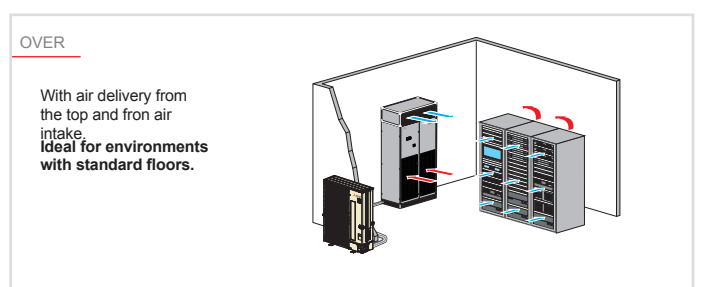
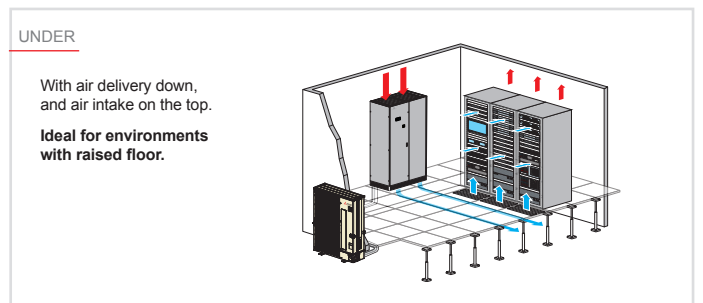

s-MEXT G00 Indoor Unit

R32

PRECISION CONDITIONER
(INDOOR UNIT)

ABLE TO MANAGE TEMPERATURE
AND HUMIDITY VARIABLES, WITH
EXTREME PRECISION, EVEN IN
THE EVENTS OF LARGE LOADS
VARIATIONS



DESIGNED TO PERFECTLY COMBINE
EFFICIENCY AND RELIABILITY IN
ALL OPERATING CONDITIONS,
THESE INDOOR UNITS USE ONLY
CERTIFIED AND HIGH QUALITY
COMPONENTS: EC FAN, DX COIL
WITH HYDROLYSIS TREATMENT
AND ADVANCED CONTROL
SYSTEM.

A WIDE RANGE OF ACCESSORIES
COMPLETES THE SERIES AND
MAKES S-MEXT SUITABLE
FOR THE MOST CRITICAL
ENVIRONMENTAL CONDITIONS

Quick and easy installation

The construction features and the unit layout have been designed to ensure quick installation and facilitate front access for easy maintenance activity.

New EC inverter fan

High performance EC fan ensures a perfect modulation of air flow for partial loads. Made of ultra-light polymeric material, this fan is distinguished by:

- Sound level reduction by 4-5 dB(A);
- Reduction of 25% of power consumption, compared to traditional solutions.

Advanced Control System

Control System is the heart of the unit. Designed for monitoring and to operate the functional and environmental single unit's parameters. The Control System allows:

- Automatic reset after power failures;
 - Serial interconnection with most modern BMS systems;
 - up to 100 events recording;
 - "Non-volatile" data storage for saving files;
- Via simple and intuitive graphic display.



Technical specifications

MODEL			006	009	013	022	028	038	044
	Outdoor unit	n°	1	1	1	1	1	2	2
	Model	PUZ-ZM	60 VHA	100 VKA	125 VKA/125 YKA	250 YKA	250 YKA	200 YKA	250 YKA
Cooling (1)	Cooling capacity	kW	6,82	10,1	11,9	22,6	28	39	42,5
	Sensible	kW	6,18	8,91	10,2	19,3	26,2	33,6	35,3
	SHR (2)		0,91	0,88	0,86	0,85	0,94	0,86	0,83
	System EER (nominal) 27°C - 47% RH		4,67	4,3	3,49	3,18	2,68	3,58	2,88
Supply Fan	Supply Fan	n°	1	1	1	2	1	1	1
	Air flow	m³/h	2000	2500	2800	5000	7600	8800	10000
	Nominal external static pressure	Pa	20	20	20	20	20	20	20
	Maximum external static pressure	Pa	208	22	110	21	305	129	20
	Power input (3)	kW	0,21	0,35	0,47	0,7	0,64	1,43	1,96
Indoor unit electrical data	Absorbed current (3)	A	1,5	2,1	2,7	3	2,1	2,1	2,8
	Starting current	A	2	2	2,8	3,3	3,8	3,8	3,8
	Maximum absorbed current	A	2,3	2,3	2,8	3,9	3,8	3,8	3,8
	Electrical panel Power input	kW	0,14	0,14	0,14	0,14	0,14	0,14	0,14
Sound level (ISO 3744) (4)	Pressure level	dB(A)	53	57	61	60	60	63	37
	Power level	dB(A)	69	73	77	76	76	79	83
Air Filters	Air Filters	n°	1	1	1	2	4	4	4
	Extended filtering surface	m²	0,68	0,68	0,68	1,05	1,76	1,76	1,76
	Efficiency (ISO EN 16890)	COARSE	60%	60%	60%	60%	60%	60%	60%
Refrigerant circuits	n°	1	1	1	1	1	2	2	
Power supply	V/Ph/Hz	230/1/50	230/1/50	230/1/50	230/1/50	400/3+N/50	400/3+N/50	400/3+N/50	
Dimensions	Length	mm	600	600	600	1000	1000	1000	1000
	Depth	mm	500	500	500	500	500	890	890
	Height	mm	1980	1980	1980	1980	1980	1980	1980
Net Weight	Over	kg	103	106	110	165	237	237	237
	Under	kg	110	115	120	175	247	247	247
Connections	Refrigerant pipes: Gas - Liquid	Ø Inch	5/8" - 3/8"	5/8" - 3/8"	5/8" - 3/8"	1" - 1/2"	1" - 1/2"	1" - 3/8"	1" - 1/2"
	Condensate (5)	Ø mm	19	19	19	19	19	19	19
	Power supply wiring cable (6)	n° x mm²	3G1.5	3G1.5	3G1.5	3G1.5	5G1.5	5G1.5	5G1.5

Notes:

THE COOLING CAPACITY DOES NOT CONSIDER THE SUPPLY FAN MOTOR THERMAL LOAD

(1) Gross value. Characteristics referred to entering air at 27°C-47% RH; Ambient temperature 35°C; ESP=20Pa; Connection pipes length 5m;

(2) SHR= Sensible cooling capacity / Total cooling capacity.

(3) Corresponding to the nominal ESP=20Pa.

(4) Sound pressure level on air return at 1m .

(5) Rubber pipe-referred to internal diameter.

(6) Minimum section.

These units contain <HFC R32 [GWP100 675]> fluorinated greenhouse gas.

Mr. SLIM

OUTDOOR UNIT

OUTDOOR UNIT EQUIPPED
WITH DC SCROLL INVERTER
COMPRESSOR AND AXIAL FANS
WITH DC ELECTRIC MOTOR

THE HEAT EXCHANGER IS THUS
EXPLOITED ENTIRELY IN ITS
EXCHANGE SURFACE.



OUTDOOR UNIT THAT BENEFIT
FROM SCROLL COMPRESSOR,
IS ALSO EQUIPPED WITH
A DEVICE CALLED "POWER
RECEIVER", A REFRIGERANT
ACCUMULATOR ACCOMPANIED
BY A PAIR OF LEV VALVES,
WITH THE DUAL FUNCTION
(SUBCOOLING/OVERHEATING THE
REFRIGERANT).

Technologies and Functions

Mr.Slim presents excellent performances in all loading conditions thanks to the sophisticated power inverter technology with advanced features:

- “Rotation and Backup” function for automatic switching on a second unit in case of first unit block
- “Easy and fast maintenance” function and automatic monitoring of the refrigerant status

Linear Expansion Valve (LEV)

The Mr.Slim linear expansion valve (LEV) allows precise regulation of the refrigerant flow, optimizing the compressor's performances:

- Fast achievement of system stability
- Quick adaptation to load fluctuations

Scroll Inverter compressor

Full inverter technology applied to the compressor allows continuous modulation of the cooling capacity according to the real needs of the servers.

In this way the rotation speed is continuously modulated helping to significantly increase the efficiency for partial loads:

- Elimination of inrush currents
- Energy consumption reduction for 25%, compared to traditional ON/OFF technology
- Maximum reliability thanks to continuous modulation without annoying ON/OFF cycles



Technical specifications

OUTDOOR UNIT			PUZ-ZM 60 VHA	PUZ-ZM 100 VKA	PUZ-ZM 125 YKA	PUZ-ZM 200 YKA	PUZ-ZM 250 YKA
Power supply		V/Ph/Hz	230/1/50	230/1/50	400/3+N/50	400/3+N/50	400/3+N/50
Compressor	Compressor	n°	1	1	1	1	1
	Power input ⁽¹⁾	kW	1,19	1,88	2,82	4,33	6,01
	Refrigerant charge ⁽²⁾	kg	2,8	4	4	7,1	7,7
Condenser fan	Condenser fan	n°	1	2	2	2	2
	Air flow	m³/h	3300	6600	7200	8400	8400
	Power input ⁽¹⁾	kW	0,06	0,06	0,06	0,2	0,2
Dimensions	Length	mm	950	1050	1050	1050	1050
	Depth	mm	355	370	370	370	370
	Height	mm	943	1338	1338	1338	1338
	Weight	kg	70	116	125	135	135

Notes:

(1) Characteristics referred to ambient temperature 35°C – indoor air condition 27°C-47% UR - Connection pipes length 5m;

(2) Standard refrigerant charge.

(+) for additional refrigerant charge please refer to Mr Slim O&M Manual.

These units contain <HFC R32 [GWP100 675]> fluorinated greenhouse gas.



MULTIDENSITY modular system

Efficient, rational, plug & play solution for high density data rooms.
Full inverter VRF system for small & medium size it environments
with hot spots up to 50 kW.



Up to 8 indoor units connected to one OUTDOOR unit

High density hot spots are managed by indoor units connected to condensing units working together as a unique system.



Highest capacity per footprint

Thanks to the possibility to minimise the number of outdoor units, the overall footprint of the whole system is drastically reduced.

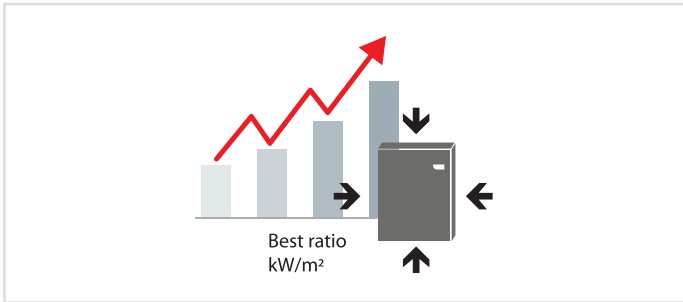

Choose your system's reliability

A multitude of configurations are available to provide customers with their desired level of reliability (configuration N, N+1, 2N). The Multidensity system is in line with TIER III and IV design topologies, based on the configuration chosen.

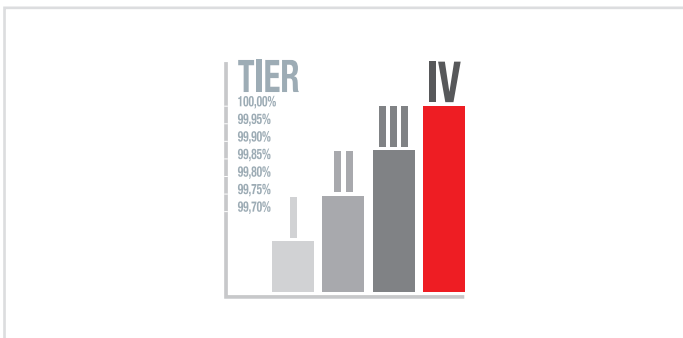

Adaptable flexibility

Match any kind of cooling requirement, from localised cooling to hot and cold aisle cooling management.

Rational design for optimised CAPEX

The rational design of the VRF system is combined with the experience and reliability of the Mitsubishi Electric brand, which guarantees the best quality for your IT infrastructure.

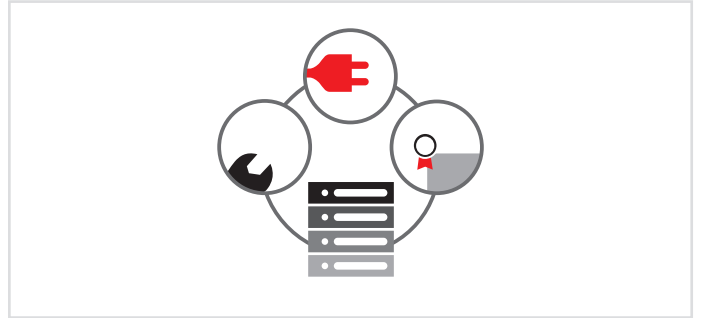

Plug and Play Installation

PLUG & PLAY SOLUTIONS No additional elements such as pumps, tanks, and valves are required. This installation simplicity results in a quicker start-up and more reliable maintenance, which are key factors for reducing installation and maintenance costs.

Active Redundancy

Active Redundancy Advanced load sharing logics of the Active Redundancy function ensure that the heat loads are balanced among the units (including those units that usually remain in stand-by) according to the actual requirements of the IT infrastructure, leveraging on the multi-unit configuration of redundant systems.

The modular approach of MULTIDENSITY SYSTEM

Indoor units are connected in master-slave configuration, if the master unit fails for any reason, the Dynamic Master logic automatically elects a new master from the other units.

Thanks to the flexible and modular approach of the MULTIDENSITY SYSTEM, it represents a tailored solution for any data center layout.

CONFIGURATION WITHOUT REDUNDANCY (N)

Ideal for small to medium IT rooms

- 1 external unit paired with up to 8 indoor units
- Average system EER is around 3.00
- Cooling capacity up to 50 kW

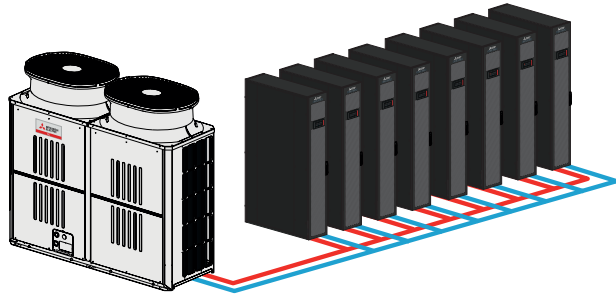

CONFIGURATION WITH REDUNDANCY (N+1)

Ideal for TIER II IT rooms

- 2 external units paired with up to 8 indoor units
- The external units operate in load sharing at partial loads for higher efficiency
- In case of failure of one of the condensing units, the second one operates at full load
- Average system EER is around 3.25
- Cooling capacity up to 50 kW

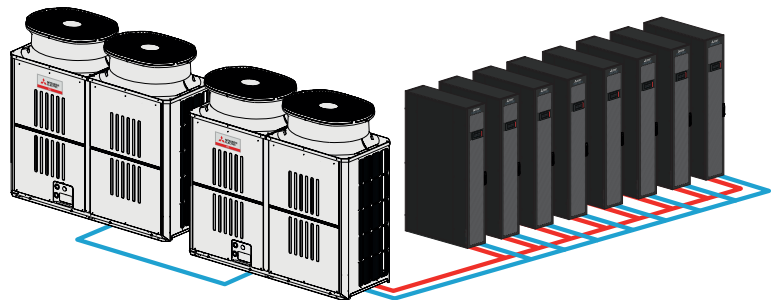

CONFIGURATION (2N)

Ideal for TIER III and TIER IV data centers

In accordance with the Uptime's Institute's classification, this configuration offers:

- A fully redundant and mirrored system with two independent distribution systems
- 1+1 external units paired with up to 8+8 indoor units

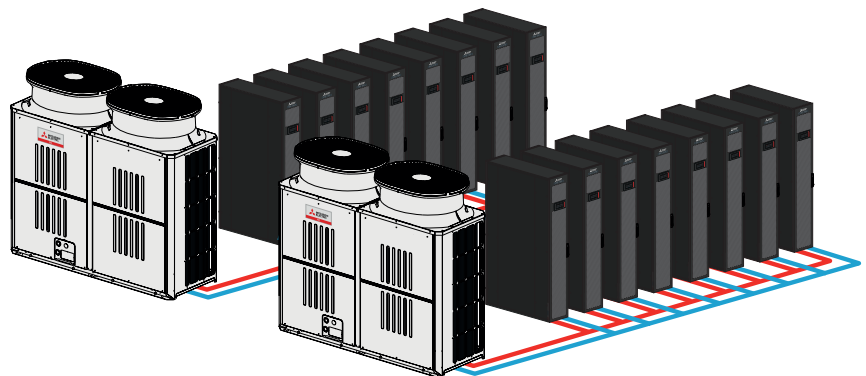

New evolution touch display

The evolution touch display is available for the room units m-MROW and m-MRAC. Through simple, easy-to-read colour graphics, the innovative touch screen display (available as an option) shows the real performance of key components.

A completely redesigned interface improves the user experience. The 7" touch screen display ensures the immediate visualization of the indoor units' status thanks to dedicated screens for main operating parameter control: temperature, humidity, ventilation and then, alarms and event management.

NEW EVOLUTION TOUCH DISPLAY

MULTILINGUE WEB BASED ACCESS

INTUITIVE ICONS for better user experience

QUICK MENÙ ACCESS

REAL-TIME DISPLAY of main operating variables

KIPLink innovative interface

Multidensity system is also available, as option, with KIPLink interface. Based on WI-FI technology, KIPLink gets rid of the standard keyboard and allows one to operate on the unit directly from a mobile devices (smartphone, tablet, notebook).

KIPLINK INNOVATIVE INTERFACE

KIPLINK INNOVATIVE INTERFACE

Easier on-site operation
View and change all parameters with easy-to-understand screenshot and dedicated tooltips. Get devoted "help" messages for alarm reset and trouble shooting.

Real-time graphs and trends
Monitor the immediate labour status of main components. View the real-time graphs of the key operating variable trends.

Data logger function
View history of events and use the filter for a simple search. Enhance diagnostics with data and graphs of 10 minutes before and after each alarm. Download all the data for detailed analysis.

KIPLINK INNOVATIVE INTERFACE

Dimensioning and design

Thanks to the sizing and design tool typical of Mitsubishi Electric direct expansion systems - New Design Tool – it's possible to simplify the design phases by minimizing the learning curve.

m-MOCU

AIR-COOLED OUTDOOR UNIT FOR OUTDOOR INSTALLATION
TO BE COUPLED WITH IT COOLING INDOOR UNITS

mitsubishi electric's
experience in vrf
applied to it cooling
infrastructures

bell-mouth shape
designed propeller
fans with inverter
control brushless
dc motors

bldc scroll compressors
with inverter technology to
produce the exact output
needed by the system

modular design and
reduced footprint
for any installation
requirement

increased performance

extreme reliability

suitable for long
refrigerant pipe distance

low noise operation



Technical specifications CONDENSING UNITS				
Outdoor Unit			1x m-MOCU-G02-050	2x m-MOCU-G02-050
Cooling Capacity	Total ⁽¹⁾	kW	50	50
	System EER ⁽¹⁾	kW/kW	2.96	3.24
Unit Electrical Data	Power input ⁽¹⁾	kW	15.2	13.7
Compressor		Nr.	1	2x 1
	Power input ⁽¹⁾	kW	14.3	2x 14.3
Condenser Fans		Nr.	2	2x 2
	Total air flow	m ³ /h	19.200	2x 19.200
	Power input	kW	2x 0.92	4x 0.92
	External static pressure	Pa	0	0
Sound Level Iso 3744	Pressure level ⁽²⁾	dB(A)	65	68
Refrigerant Circuits		Nr.	1	2x 1
	Refrigerant type		R410A	R410A
	Pre-charged refrigerant	kg	11.8	2x 11.8
	F-GAS - CO ₂ equivalent	t	24.63	2x 24.63
Refrigerant Piping	Max pipe length (from the outdoor unit to the farthest indoor unit)	m	165	165
	Max height difference (outdoor unit higher than indoor units)	m	50	50
	Max height difference (outdoor unit lower than indoor units)	m	40	40
Power Supply		V/Ph/Hz	380-400-415 / 3+N / 50-60	380-400-415 / 3+N / 50-60
Dimensions	Length	mm	1750	2x 1750
	Depth	mm	740	2x 740
	Height	mm	1650	2x 1650
Net Weight		kg	304	2x 304

1. Gross Value. Characteristics referred to room air temperature 35°C with 27%RH and external ambient air temperature 35°C. ESP=20Pa.

2. Gross Value. Characteristics referred to room air temperature 46°C with 16%RH and external ambient air temperature 35°C. ESP=20Pa.

3. Sound pressure level on air return at 1m.

m-MROW m-MRAC

THESE INDOOR RACK COOLING UNITS, FROM 10 TO 28 KW,
ARE DESIGNED TO BE CLOSE-COUPLED TO BLADE SERVERS AND MANAGE HOT SPOTS

OPTIMIZED FOR MULTIDENSITY
SYSTEM

REDUCED SPACE OCCUPANCY
(UP TO 0,36 M²)

COOLING ONLY WHERE NEEDED

EC PLUG FANS FOR
REDUCING ENERGY
CONSUMPTION
AND NOISE LEVELS

ELECTRONIC EXPANSION
VALVE TO ACHIEVE
A MUCH WIDER
MODULATION CAPACITY

BOTH IN-ROW AND
ENCLOSURE
VERSIONS AVAILABLE



ENCLOSURE
IDEAL FOR REMOVING
HOT SPOTS IN STAND
ALONE SYSTEMS



IN ROW
IDEAL FOR HOT/COLD
AISLE CONFIGURATIONS

Technical specifications INDOOR UNITS					
Indoor unit			m-MROW-G02-009	m-MROW-G02-015	m-MROW-G02-025
			m-MRAC-G02-009	m-MRAC-G02-015	m-MRAC-G02-025
Unit size			9	15	25
Cooling capacity m-MROW	Total (1)	kW	10.6	16.6	28.6
	Sensible (1)	kW	9.6	15.7	27.4
	SHR (1)		0.91	0.94	0.96
	Indoor unit EER (1)	kW/kW	58.9	50.3	32.5
Cooling capacity m-MROW	Total (2)	kW	10.9	22.9	32.8
	Sensible (2)	kW	10.9	22.9	32.8
	SHR (2)		1	1	1
	Indoor unit EER (2)	kW/kW	60.5	69.3	37.2
Supply fan		Nr.	2	4	5
	Air flow	m³/h	1500	2700	4200
	Power input	kW	0.18	0.34	0.85
	Nominal external static pressure	Pa	20	20	20
	Maximum external static pressure	Pa	60	60	60
Sound level ISO 3744	Pressure level (3)	dB(A)	63.5	64.5	70.5
	Power level	dB(A)	79.0	80.0	86.0
Air filters		Nr.	2	2	2
	Extended filtering surface	m²	0.35	0.35	0.35
	Efficiency (ISO EN 16890)	COARSE	40%	40%	40%
Refrigerant circuits		Nr.	1	1	1
	POWER SUPPLY	V/Ph/Hz	230/1/50-60	230/1/50-60	230/1/50-60
Dimensions	Width	mm	300	300	300
	Length	mm	1000 / 1200	1000 / 1200	1000 / 1200
	Height	mm	2085	2085	2085
Net weight	m-MROW	kg	175	190	193
	m-MRAC	kg	185	200	203





LIVING ENVIRONMENTAL SYSTEMS

Mitsubishi Electric Europe B.V. Italian Branch

Via Energy Park, 14

20871 Vimercate (MB)

Phone: +39 039 60531

Fax: +39 039 6057694

e-mail: clima@it.mee.com

The equipment described in this catalogue contain fluorinated gasses such as HFC-32 (GWP 675), HFC-410A (GWP 2088). Installation of those equipment must be executed by professional installer based on EU reg. 303/2008 and 517/2014

COMFORT & IT COOLING SYSTEMS FULL PRODUCT
CATALOGUE 2024
E-2404250 (18711)

Specifications are subject to change without notice



E-2404250



ies.mitsubishielectric.it/en/products/